



**Hardware Maintenance Service
for Service Level A**

Machine Types 6266, 6270, 6276, 6279, 6280 and 6286

Note

Before using this information and the product it supports, be sure to read the general information under on page 5.

First Edition (July 2001)

The following paragraph does not apply to any state or country where such provisions are inconsistent with local law:

INTERNATIONAL BUSINESS MACHINES CORPORATION PROVIDES THIS PUBLICATION "AS IS" WITHOUT WARRANTY OF ANY KIND, EITHER EXPRESSED OR IMPLIED, INCLUDING, BUT NOT LIMITED TO, THE IMPLIED WARRANTIES OF MERCHANTABILITY OR FITNESS FOR A PARTICULAR PURPOSE. References to IBM products, programs, or services do not imply that IBM intends to make them available outside the United States. This publication could include technical inaccuracies or typographical errors. Changes are periodically made to the information herein; these changes will be made in later editions. IBM may make improvements and/or changes in the product(s) and/or the program(s) at any time. Address comments about this publication to IBM Corporation, Dept. E23/962-2, 455 Park Place, Lexington, KY 40511-1856, USA. Information you supply may be used by IBM without obligation. For copies of publications related to this product, call toll free 1-800-IBM-7282 in the Continental U.S.A. In Canada, call toll free 1-800-465-7999.

**© Copyright International Business Machines Corporation 2000.
All rights reserved.**

Note to U.S. Government Users – Documentation related to restricted rights – Use, duplication or disclosure is subject to restrictions set forth in GSA ADP Schedule Contract with IBM Corp.

Contents

Notices	5
Voltage Supply Switch Settings	5
Safety Information	6
Laser Compliance Statement	24
Trademarks	25
Preface	26
General Information	27
Product Overview	29
Hardware Interfaces	32
CMOS Reset	33
Flash (BIOS/VPD) update procedure	34
BIOS Setup Utility	35
Working with the Setup Menus	35
Starting the Setup Utility	35
Advanced Setup	38
Power Management Setup	39
ISA Legacy Resources	39
System Security	39
Specifications	41
Operating Requirements	42
Special Tools	43
CheckProcedures	45
Introduction	46
Start	47
Index of Symptoms, Messages, Error Codes, or Beeps	50
Troubleshooting	59
Factory-Installed Storage Devices	60
Factory-Installed Modem Card	61
Audio (Not Supported by Diagnostics Program)	62
CD-ROM Drive	63
Memory	64
Keyboard	64
Mouse	65
Power Supply	66
Monitor	68
Undetermined Problems	69
Diagnostic Aids	71
Introduction	72
Power-On Self Test	73
Diagnostics Tools	74
Using Diagnostics Program from Recovery CD	74
Diagnostics Program Features	75
Repair Information	77
Removals and Replacements of Machine Types 6270, 6276, 6279 and 6280	78
Identifying the Parts of the System Unit	79
Top Cover	81
Adapter Cards	82
Diskette Drive	83
CD-ROM Drive	84
Hard Disk Drive	85
System Board	86
Power Supply	87
Memory (DIMM)	88
Removals and Replacements of Machine Types 6266 and 6286	89
Identifying the Parts of the System Unit	90
Top Cover	91
Adapter Cards	92
Diskette Drive	93
CD-ROM Drive	94
Hard Disk Drive	95
System Board	96
Power Supply	97
Memory (DIMM)	98

Parts/Test Point Locations	99
Introduction	100
Layout of System Board of Machine Types 6266, 6270, 6276, 6279	101
Connectors and Functions of System Board of Machine Types 6266, 6270, 6276, 6279	102
Power Supply Cable Connector Specifications	103
Main Output Pin Assignment	104
Factory-Installed Modem Card Layout	106
Factory-Installed Modem Card Connector Functions	106
3.5-In. Hard Disk Drive Jumper Locations & Settings	107
CD-ROM Drive	108
CD-ROM Drive Rear Panel Connectors and Features	108
CD-ROM Drive Jumper Settings	109
DIMM Configurations	110
System Board Connector Pin Signals	111
Monitor Port Signals	111
Serial Port Signals	111
Parallel Port Signals	111
Mouse Port Signals	111
Keyboard Port Signals	112
Diskette Drive Cable Connector Signals	113
IDE Cable Connector Signals	114
Safety Inspection Guide.....	115
General Guidelines.....	116
Parts Catalog of Machine Type.....	117
Parts Catalog of Machine Types 6270, 6276, 6279 and 6280	118
Assembly 1: System Unit.....	118
Assembly 2: Diskette Drive, Hard Disk Drive	120
Assembly 3: CD-ROM, Modem Card	121
Assembly 4: Keyboard and Mouse	123
Parts Catalog of Machine Types 6266	126
Assembly 2: Diskette Drive, Hard Disk Drive	128
Assembly 3: CD-ROM, Modem Card	129
Assembly 4: Keyboard and Mouse	130
Appendix A. Online Support Information.....	132

Notices

References in this publication to IBM products, programs, or services do not imply that IBM intends to make these available in all countries in which IBM operates. Any reference to an IBM product, program, or service is not intended to state or imply that only IBM's product, program, or service may be used. Any functionally equivalent product, program, or service that does not infringe any of IBM's intellectual property rights, or other legally protectable rights, may be used instead of the IBM product, program, or service. References in this publication to IBM products, programs, or services are purely hardware-related and do not cover circumstances of software problems. Evaluation and verification of operation in conjunction with other products, program, or services, except those expressly designated by IBM are the user's responsibility. IBM may have patents or pending patent applications covering subject matter in this document. The featuring of these patents, pending or otherwise, in this document does not give you any license to these patents. You can send license inquires, in writing, to the IBM Director of Commercial Relations, IBM Corporation, Purchase, NY10577.

Voltage Supply Switch Settings

Your IBM Personal Computer *might* have voltage switches, which must be set correctly for your voltage supply. If your monitor or system unit has a voltage switch, complete these steps to make sure each switch is set correctly:

1. Determine the correct voltage switch setting for your area:

<u>Voltage Supply Range</u>	<u>Voltage Switch Setting</u>
100-127 V	115 V
200-240 V	220 V

2. Locate the voltage switch on the back of your monitor or system unit. If the setting shown on the switch is:

- Correct: start setting up your IBM personal computer.
- Incorrect: change the voltage switch setting.

Safety Information



DANGER

To avoid a shock hazard, do not connect or disconnect any cables or perform installation, maintenance, or reconfiguration of this product during an electrical storm.

To avoid shock hazard:

- The power cord must be connected to a properly wired and grounded receptacle.
- Any equipment to which this product will be attached must also be connected to properly wired receptacles.

When possible, use one hand to connect or disconnect signal cables to prevent a possible shock from touching two surfaces with different electrical potentials.

Electrical current from power, telephone, and communications cables is hazardous. To avoid shock hazard, connect and disconnect cables as described following when installing, moving, or opening covers of this product or attached devices.

To Connect	To Disconnect
1. Turn Everything OFF.	1. Turn Everything OFF.
2. First, attach all cables to devices.	2. First, remove power cord(s) from outlet
3. Attach signal cables to receptacles.	3. Remove signal cables from receptacles.
4. Attach power cord(s) to outlet.	4. Remove all cables from devices.
5. Turn device ON	



Caution:

When replacing the battery, use only IBM Part Number 36L9077 or an equivalent type battery recommended by the manufacturer. If your system has a module containing a lithium battery, replace it only with the same module type made by the same manufacturer. The battery contains lithium and can explode if not properly used, handled, or disposed of.

Do not:

- Throw or immerse into water
- Heat to more than 100°C (212°F)
- Repair or disassemble

Dispose of the battery as required by local ordinances or regulations.



Caution:

When a CD-ROM drive is installed, note the following.

Use of controls or adjustments or performance of procedures other than those specified herein might result in hazardous radiation exposure.

Removing the covers of the CD-ROM drive could result in exposure to hazardous laser radiation. There are no serviceable parts inside the CD-ROM drive. Do not remove the CD-ROM drive covers.

DANGER

Some CD-ROM drives contain an embedded Class 3A or Class 3B laser diode. Note the following.

Laser radiation when open. Do not stare into the beam, do not view directly with optical instruments, and avoid direct exposure to the beam.



≥32 Kg
(70.5
lbs) (121.2
lbs)

≥55Kg

Caution:

Use safe lifting practices when lifting your machine.



Caution:

Electrical current from power, telephone, and communication cables can be hazardous. To avoid personal injury or equipment damage, disconnect the attached power cords, telecommunications systems, networks, and modems before you open the covers, unless instructed otherwise in the installation and configuration procedures.



PERIGO

Para evitar choques elétricos, não conecte ou desconecte nenhum cabo, nem efetue instalação, manutenção ou reconfiguração deste produto durante uma tempestade com raios.

Para evitar choques elétricos:

- O cabo de alimentação deve ser conectado a um receptáculo corretamente instalado e aterrado.
- Todos os equipamentos aos quais este produto será conectado devem também ser conectados a receptáculos corretamente instalados.

Quando possível, utilize uma das mãos para conectar ou desconectar cabos de sinal, para evitar um possível choque ao tocar duas superfícies com potenciais elétricos diferentes.

A corrente elétrica proveniente de cabos de alimentação, de telefone e de comunicação é perigosa. Para evitar choques elétricos, conecte e desconecte os cabos conforme descrito a seguir, ao instalar, movimentar ou abrir tampas deste produto ou de dispositivos conectados.

Para Conectar	Para Desconectar
1. DESLIGUE tudo.	1. DESLIGUE tudo.
2. Conecte primeiro todos os cabos nos dispositivos.	2. Remova primeiro o(s) cabo(s) de alimentação das tomadas.
3. Conecte os cabos de sinal nos receptáculos.	3. Remova os cabos de sinal dos receptáculos.
4. Conecte o(s) cabo(s) de alimentação nas tomadas.	4. Remova todos os cabos dos dispositivos.
5. LIGUE o dispositivo.	



cuidado:

Ao substituir a bateria, utilize apenas o Número de Peça IBM 36L9077 ou um tipo de bateria equivalente recomendado pelo fabricante. Se seu sistema possuir um módulo com uma bateria de lítio, substitua-o apenas pelo mesmo tipo de módulo, produzido pelo mesmo fabricante. A bateria contém lítio e pode explodir se não for utilizada, manuseada e descartada de forma adequada.

Não:

- Jogue ou coloque na água
- Aqueça a mais de 100°C (212°F)
- Conserte nem desmonte.

Descarte a bateria conforme requerido pelas disposições e regulamentações locais.



cuidado:

Quando uma unidade de CD-ROM estiver instalada, observe o seguinte.

A utilização de controles ou ajustes ou a execução de procedimentos diferentes daqueles especificados nesta publicação pode resultar em exposição perigosa à radiação.

A remoção das tampas da unidade de CD-ROM pode resultar em exposição a radiação perigosa de laser. Não existem peças que possam ser consertadas no interior da unidade de CD-ROM. Não remova as tampas da unidade de CD-ROM.

PERIGO

Algumas unidades de CD-ROM contém um diodo de laser da Classe 3A ou da Classe 3B. Observe o seguinte.

Radiação de laser quando aberto. Não olhe diretamente para o feixe de laser, não olhe diretamente com instrumentos óticos, e evite exposição direta ao raio.



≥32 Kg (70,5 lbs)	≥55Kg (121,2 lbs)
-------------------------	-------------------------

cuidado:

Utilize práticas seguras para levantamento de peso ao levantar sua máquina.



cuidado:

A corrente elétrica proveniente de cabos de alimentação, de telefone e de comunicação é perigosa. Para evitar ferimentos pessoais ou danos aos equipamentos, desconecte os cabos de alimentação, sistemas de telecomunicação, redes e modems antes de abrir as tampas, a menos que receba outras instruções nos procedimentos de instalação e configuração.

声明 1



危险!

为避免电击危险，请不要在暴风雨期间连接或断开任何电缆，或是进行此产品的安装、维护或重新配置操作。

为避免电击危险：

- 电源线必须连接到适当的电线及接地插座。
- 此产品将要连接的所有设备也必须连接到正确接线的插座上。

如果可能，请使用一只手连接或断开连接信号电缆，以避免在接触两个具有不同电势的表面时遭到电击。

电源线、电话线以及通信电缆中的电流非常危险。为避免电击，请在安装、移动或打开本产品或连接设备的外盖时，按照下述步骤连接或断开电缆。

要连接电缆

1. 关闭所有设备。
2. 首先将所有电缆与设备连接。
3. 将信号线连接到插座。
4. 将电源线连接到电源插座。
5. 打开设备。

要断开电缆

1. 关闭所有设备。
2. 首先从电源插座拔下电源线。
3. 从插座拔下信号电缆。
4. 从设备上拔下所有电缆。

声明 2



注意!

当更换电池时，仅可使用 IBM 部件号为 33F8354 的产品或由制造商推荐的同等电池。如果系统中有包含锂电池的模块，则只能使用由相同制造商制造的相同类型模块更换。该电池含有锂，如果使用、操作或处理不当会发生爆炸。

不要：

- 将其投入或浸于水中
- 加热超过100°C (212°F)
- 修理或拆卸

应按照当地法规和条例对此电池进行处理。

声明 3



注意!

在已安装 CD-ROM 驱动器的情况下，请注意下面的内容。

不遵循此处指定的控制、调整、或操作过程的操作将可能导致危险的辐射泄漏。

取下 CD-ROM 驱动器的外盖会导致危险的激光辐射泄漏。CD-ROM 驱动器内没有可以使用的部件。请不要取下 CD-ROM 驱动器的外盖。

声明 4

危险！

一些 CD-ROM 驱动器中包含内置的 3A 类或 3B 类激光二极管。
请注意下述内容。

打开驱动器会产生激光辐射。请不要凝视激光束，请不要使用光学仪器直接观看激光束，同时也要避免人体直接暴露在激光束下。

声明 5



32 kg (70.5 磅)



55 kg (121.2 磅)

注意！

搬运机器时，请进行安全搬运操作。

声明 10



注意！

电源线、电话线以及通信电缆中的电流非常危险。为避免人身伤害或设备损坏，除非在安装和配置过程中特别指明，请在打开服务器外盖前断开已连接的全部电源线、电信系统、网络及调制解调器。

• 聲明 1



危險

為了避免雷擊，在閃電期間，請勿連接或拔掉本裝置上的任何電纜線，或請勿安裝、維修或重新架構本產品。

為了避免雷擊：

- 電源線必須連接到接線及接地正確的插座。
- 本產品所連接的設備也必須連接到接線正確的插座。

儘可能使用單手來連接或拔掉信號電纜，以避免因接觸兩不同電位的平面，而受到電擊。

電源、電話及通信電纜上均有電流通過。為了避免電擊，在安裝、移動本產品，或開啓本產品的蓋子或與本產品連接之裝置的蓋子時，請依照下列「連接」及「拔掉」電纜線的步驟操作。

• 聲明 2



注意：

更換電池時，只可使用 IBM 零件編號 33F8354 的電池，或廠商建議的相當類型的電池。如您系統中的模組含有鋰電池，更換時，請使用相同廠商製造的相同模組類型。如未正常使用、處理或捨棄含有鋰的電池時，可能會造成爆炸。

嚴禁：

- 丟入或浸入水中
- 加熱超過攝氏100度（華氏 212 度）
- 修補或拆解

處理廢棄電池時，請遵照當地法令規章處理。

連接

拔掉

- | | |
|---|---|
| <ol style="list-style-type: none">1. 關掉所有開關。2. 首先，將所有電纜線連接到裝置。3. 將信號電纜連接到信號插座。4. 將電源線連接到電源插座。5. 開啓裝置電源。 | <ol style="list-style-type: none">1. 關掉所有開關。2. 首先，自電源插座拔掉電源線。3. 拔掉信號插座上的所有信號電纜。4. 拔掉裝置上的所有電纜線。 |
|---|---|

• 聲明 3



注意：

安裝光碟機時，請注意下列事項：

不依此處所指示的控制、調整或處理步驟，恐有遭致輻射之虞。

移開光碟機蓋子，恐有遭致雷射輻射之虞。光碟機中沒有需要維修的部分。請勿移開光碟機的蓋子。

• 聲明 4



危險

光碟機含有內嵌式 Class 3A 或 Class 3B 雷射二極體時，請注意下列事項：

開啓時會產生雷射輻射。請勿凝視光束，不要使用光學儀器直接觀察，且應避免直接暴露在光束下。

• 聲明 5



≥ 32 公斤 (70.5 磅)



≥ 55 公斤 (121.2 磅)

注意：
提昇機器時，請使用安全提昇措施。

• 聲明 10



注意：
電源、電話及通信電纜上均有電流通過。在安裝及架構之時，若非專家指導，為了避免人員受傷、設備受損，在開啓伺服器蓋子之前，請切斷電源線、電信系統、網路及數據機。



DANGER

Pour éviter tout risque de choc électrique, ne manipulez aucun câble et n'effectuez aucune opération d'installation, d'entretien ou de reconfiguration de ce produit au cours d'un orage.

Pour éviter tout risque de choc électrique :

- Les cordons d'alimentation du présent produit et de tous les appareils qui lui sont connectés doivent être branchés sur des socles de prise de courant correctement câblés et mis à la terre.

Afin d'éviter tout risque de choc électrique provenant d'une différence de potentiel de terre, n'utilisez qu'une main, lorsque cela est possible, pour connecter ou déconnecter les cordons d'interface.

Le courant électrique passant dans les câbles de communication, ou les cordons téléphoniques et d'alimentation peut être dangereux. Pour éviter tout risque de choc électrique, lorsque vous installez ou que vous déplacez le présent produit ou des périphériques qui lui sont raccordés, reportez-vous aux instructions ci-dessous pour connecter et déconnecter les différents cordons.

Connexion	Déconnexion
1. Mettez les unités hors tension.	1. Mettez les unités hors tension.
2. Commencez par brancher tous les cordons sur les unités.	2. Commencez pas débrancher les cordons alimentation des socles de prise de courant.
3. Branchez les câbles d'interface sur les prises.	3. Débranchez les câbles d'interface des prises.
4. Branchez les cordons d'alimentation sur un socle de prise de courant.	4. Débranchez tous les câbles des unités.
5. Mettez les unités sous tension.	



attention:

Remplacez la pile usagée par une pile de référence identique exclusivement - voir la référence IBM - ou par une pile équivalente recommandée par le fabricant. Si votre système est doté d'un module contenant une pile au lithium, vous devez le remplacer uniquement par un module identique, produit par le même fabricant. La pile contient du lithium et présente donc un risque d'explosion en cas de mauvaise manipulation ou utilisation.

- Ne la jetez pas à l'eau.
- Ne l'exposez pas à une température supérieure à 100°C.
- Ne cherchez pas à la réparer ou à la démonter.

Pour la mise au rebut, reportez-vous à la réglementation en vigueur.



attention:

Si une unité de CD-ROM est installée, prenez connaissance des informations suivantes :

Pour éviter tout risque d'exposition au rayon laser, respectez les consignes de réglage et d'utilisation des commandes, ainsi que les procédures décrites dans le présent document.

Pour éviter une exposition directe au rayon laser, n'ouvrez pas l'unité de CD-ROM. Vous ne pouvez effectuer aucune opération de maintenance à l'intérieur.



DANGER

Certaines unités de CD-ROM contiennent une diode laser de classe 3A ou 3B. Prenez connaissance des informations suivantes :

Rayonnement laser lorsque le carter est ouvert. Évitez de regarder fixement le faisceau ou de l'observer à l'aide d'instruments optiques. Évitez une exposition directe au rayon.



≥32 Kg ≥55Kg

attention:

Ce produit pèse un poids considérable. Faites-vous aider pour le soulever.



Le courant électrique circulant dans les câbles de communication et les cordons téléphoniques et d'alimentation peut être dangereux. Pour votre sécurité et celle de l'équipement, avant de retirer les carters, mettez celui-ci hors tension et déconnectez ses cordons d'alimentation, ainsi que les câbles qui le relient aux réseaux, aux systèmes de télécommunication et aux modems (sauf instruction contraire mentionnée dans les procédures d'installation et de configuration).



VORSICHT

Aus Sicherheitsgründen bei Gewitter an diesem Gerät keine Kabel anschließen oder lösen. Ferner keine Installations-, Wartungs- oder Rekonfigurationsarbeiten durchführen.

Aus Sicherheitsgründen:

- Gerät nur an eine Schutzkontaktsteckdose mit ordnungsgemäß geerdetem Schutzkontakt anschließen.
- Alle angeschlossenen Geräte ebenfalls an Schutzkontaktsteckdosen mit ordnungsgemäß geerdetem Schutzkontakt anschließen.

Signalkabel möglichst einhändig anschließen oder lösen, um einen Stromschlag durch Berühren von Oberflächen mit unterschiedlichem elektrischem Potential zu vermeiden.

Elektrische Spannungen von Netz-, Telefon- und Datenübertragungsleitungen sind gefährlich. Um einen Stromschlag zu vermeiden, nur nach den Anweisungen arbeiten, die für Installation, Transport oder Öffnen von Gehäusen dieses Produkts oder angeschlossenen Einheiten gelten.

Kabel anschließen	Kabel lösen
1. Alle Geräte ausschalten und Netzstecker ziehen.	1. Alle Geräte ausschalten.
2. Zuerst alle Kabel an Einheiten anschließen.	2. Zuerst Netzstecker von Steckdose lösen.
3. Signalkabel an Anschlußbuchsen anschließen.	3. Signalkabel von Anschlußbuchsen lösen.
4. Netzstecker an Steckdose anschließen.	4. Alle Kabel von Einheiten lösen.
5. Gerät einschalten.	



achtung:

Eine verbrauchte Batterie nur durch eine Batterie mit der IBM Teilenummer 36L9077 oder durch eine vom Hersteller empfohlene Batterie ersetzen. Wenn Ihr System ein Modul mit einer Lithium-Batterie enthält, ersetzen Sie es immer mit dem selben Modultyp vom selben Hersteller. Die Batterie enthält Lithium und kann bei unsachgemäßer Verwendung, Handhabung oder Entsorgung explodieren.

Die Batterie nicht

- mit Wasser in Berührung bringen.
- über 100 C erhitzen.
- reparieren oder zerlegen.

Die örtlichen Bestimmungen für die Entsorgung von Sondermüll beachten.



achtung:

Wenn ein CD-ROM-Laufwerk installiert ist, beachten Sie folgendes. Steuer- und Einstellelemente sowie Verfahren nur entsprechend den Anweisungen im vorliegenden Handbuch einsetzen. Andernfalls kann gefährliche Laserstrahlung auftreten.

Das Entfernen der Abdeckungen des CD-ROM-Laufwerks kann zu gefährlicher Laserstrahlung führen. Es befinden sich keine Teile innerhalb des CD-ROM-Laufwerks, die vom Benutzer gewartet werden müssen. Die Verkleidung des CD-ROM-Laufwerks nicht öffnen.

VORSICHT

Manche CD-ROM-Laufwerke enthalten eine eingebaute Laserdiode der Klasse 3A oder 3B. Die nachfolgend aufgeführten Punkte beachten.

Laserstrahlung bei geöffneter Tür. Niemals direkt in den Laserstrahl sehen, nicht direkt mit optischen Instrumenten betrachten und den Strahlungsbereich meiden.



≥32 Kg ≥55Kg

achtung:

Beim Anheben der Maschine die vorgeschriebenen Sicherheitsbestimmungen beachten.



achtung:

An Netz-, Telefon- und Datenleitungen können gefährliche elektrische Spannungen anliegen. Um eine Gefährdung des Benutzers oder Beschädigung des Geräts zu vermeiden, ist der Server auszuschalten. Die Verbindung zu den angeschlossenen Netzkabeln, Telekommunikationssystemen, Netzwerken und Modems ist vor dem Öffnen des Servergehäuses zu unterbrechen (in Installations- und Konfigurationsanweisungen nicht anders angegeben).



PERICOLO

Per evitare il pericolo di scosse elettriche durante i temporali, non collegare o scollegare cavi, non effettuare l'installazione, la manutenzione o la riconfigurazione di questo prodotto.

Per evitare il pericolo di scosse elettriche:

- collegare il cavo di alimentazione ad una presa elettrica correttamente cablata e munita di terra di sicurezza;
- collegare qualsiasi apparecchiatura collegata a questo prodotto ad una presa elettrica correttamente cablata e munita di terra di sicurezza.

Quando possibile, collegare o scollegare i cavi di segnale con una sola mano per evitare il rischio di scosse derivanti dal contatto con due superfici a diverso potenziale elettrico.

La corrente elettrica circolante nei cavi di alimentazione, del telefono e di segnale è pericolosa. Per evitare scosse elettriche, collegare e scollegare i cavi come descritto quando si effettuano l'installazione, la rimozione o l'apertura dei coperchi di questo prodotto o durante il collegamento delle unità.

Per collegare	Per scollegare
1. SPEGNERE tutti i dispositivi.	1. SPEGNERE tutti i dispositivi.
2. Collegare prima tutti i cavi alle unità.	2. Rimuovere prima il(i) cavo(i) di alimentazione dalla presa elettrica.
3. Collegare i cavi di segnale alle prese.	3. Rimuovere i cavi di segnale dalle prese.
4. Collegare il(i) cavo(i) di alimentazione alla presa elettrica.	4. Rimuovere tutti i cavi dalle unità.
5. ACCENDERE le unità.	



ATTENZIONE:

Quando si sostituisce la batteria, utilizzare solo una batteria IBM 36L9077 o batterie dello stesso tipo o di tipo equivalente consigliate dal produttore. Se il sistema di cui si dispone è provvisto di un modulo contenente una batteria al litio, sostituire tale batteria solo con un tipo di modulo uguale a quello fornito dal produttore. La batteria contiene litio e può esplodere se utilizzata, maneggiata o smaltita impropriamente.

Evitare di:

- Gettarla o immergerla in acqua
- Riscaldarla ad una temperatura superiore ai 100°C
- Cercare di ripararla o smaltirla

Smaltire secondo la normativa in vigore (D.Lgs 22 del 5/2/97) e successive disposizioni nazionali e locali.



ATTENZIONE:

Quando è installata un'unità CD-ROM, notare quanto segue:

L'utilizzo di controlli, regolazioni o l'esecuzione di procedure non descritti nel presente manuale possono provocare l'esposizione a radiazioni pericolose.

L'apertura di un'unità CD-ROM può determinare l'esposizione a radiazioni laser pericolose. All'interno dell'unità CD-ROM non vi sono parti su cui effettuare l'assistenza tecnica. Non rimuovere i coperchi dell'unità CD-ROM.

PERICOLO

Alcune unità CD-ROM contengono all'interno un diodo laser di Classe 3A o Classe 3B. Prestare attenzione a quanto segue:

Aperto l'unità vengono emesse radiazioni laser. Non fissare il fascio, non guardarlo direttamente con strumenti ottici ed evitare l'esposizione diretta al fascio.



≥32 Kg ≥55Kg

ATTENZIONE:

Durante il sollevamento della macchina seguire delle norme di sicurezza.



ATTENZIONE:

La corrente circolante nei cavi di alimentazione, del telefono e di segnale è pericolosa. Per evitare situazioni pericolose per le persone o danneggiamenti all'apparecchiatura, scollegare i cavi di alimentazione, i sistemi di telecomunicazioni, le reti e ed i modem prima di aprire i coperchi se non diversamente indicato nelle procedure di installazione e configurazione.

경고문 1



위험

전기 충격을 피하려면 날씨가 나쁠 때(예: 눈 또는 비가 오거나 천둥 번개가 칠 때)는 케이블을 연결하거나 끊지 않도록 하고 이 제품의 설치, 유지보수 또는 재구성 등의 작업을 수행하지 않도록 하십시오.

전기 충격을 피하려면 다음과 같아야 합니다.

- 고압선은 적절한 배선 및 정지 상태의 콘센트로 연결되어야 합니다.
- 이 제품이 접속될 모든 장비도 적절한 배서 상태의 콘센트로 연결되어야 합니다.

다른 전위를 가진 두 표면을 만졌을 때 발생할 수 있는 전기 충격을 피하려면 한 손으로 신호선을 연결하거나 끊으십시오.

전원, 전화 및 통신 케이블로부터 흘러 나오는 전류는 위험합니다. 전기 충격을 피하려면 이 제품이나 접속 장치를 설치, 이동 및 덮개를 열 때 다음 설명에 따라 케이블을 연결하고 끊도록 하십시오.

연결하려면	연결해제하려면
1. 모든 스위치를 켜다.	1. 모든 스위치를 끈다.
2. 먼저 모든 케이블을 장치에 연결한다.	2. 먼저 모든 케이블을 장치에 제거한다.
3. 신호선을 콘센트에 연결한다.	3. 신호선을 콘센트에서 제거한다.
4. 전원을 콘센트에 연결한다.	4. 장치에서 모든 케이블을 제거한다.
5. 장치 스위치를 켜다.	

경고문 2



주의:

배터리를 교체할 때는 IBM 부품 번호 &PN, 또는 제조업체에서 추천하는 동등한 유형의 배터리를 사용하십시오. 시스템에 리튬 배터리를 포함하는 모듈이 있으면 이것은 동일한 제조업체에서 생산된 동일한 모듈 유형으로만 교체하십시오. 배터리에 리튬이 포함되어 있으므로 제대로 사용, 처리 또는 처분하지 않으면 폭발할 수 있습니다.

다음을 주의하십시오.

- 먼지거나 물에 담그지 않도록 하십시오.
- 100°C(212°F) 이상으로 가열하지 않도록 하십시오.
- 수리하거나 분해하지 않도록 하십시오.

지역 법령이나 규정의 요구에 따라 배터리를 처분하십시오.

경고문 3



주의:

CD-ROM 드라이브가 설치되어 있으면 다음 사항을 명심하십시오.

여기에서 지정하지 않은 방식으로 CD-ROM 드라이브를 제어 또는 조절하거나 다른 절차로 사용하면 위험한 방사능 노출이 발생할 수 있습니다.

CD-ROM 드라이브의 덮개를 제거하면 위험한 레이저 방사능이 노출될 수 있습니다. CD-ROM 드라이브 내에는 정비할 수 있는 부품이 없습니다. CD-ROM 드라이브 덮개를 제거하지 않도록 하십시오.

경고문 4

위험

일부 CD-ROM 드라이브에는 클래스 3A 또는 3B 레이저 2급 진공관(다이오드)이 들어 있습니다. 다음 사항을 명심하십시오.

열면 레이저 방사능이 노출됩니다. 광선을 주시하거나 광학 기계를 직접 쳐다보지 않도록 하고 광선에 노출되지 않도록 하십시오.

경고문 5



32kg(70.5 파운드)



55kg(121.2 파운드)

주의:

기계를 들 때는 안전하게 들어 올리십시오.

경고문 10



주의:

전원, 전화 및 통신 케이블로부터 흘러 나오는 전류는 위험합니다. 설치 및 구성 절차에 다른 지시가 없으면, 다치거나 장비 손상이 생기지 않게 하기 위해 서버 덮개를 열기 전에 접속된 전선, 원격 통신 시스템, 네트워크 및 모뎀의 연결을 끊으십시오.



PELIGRO

Para evitar una posible descarga eléctrica, no conecte ni desconecte los cables ni lleve a cabo ninguna operación de instalación, de mantenimiento o de reconfiguración de este producto durante una tormenta eléctrica.

Para evitar una posible descarga:

- El cable de alimentación debe conectarse a un receptáculo con una instalación eléctrica correcta y con toma de tierra.
- Los aparatos a los que se conecte este producto también deben estar conectados a receptáculos con la debida instalación eléctrica.

Cuando sea posible, utilice una sola mano para conectar o desconectar los cables de señal a fin de evitar una posible descarga al tocar dos superficies con distinto potencial eléctrico.

La corriente eléctrica de los cables de comunicaciones, teléfono y alimentación puede resultar peligrosa. Para evitar una posible descarga, siga las indicaciones de conexión y desconexión de los cables siempre que tenga que instalar, mover o abrir las cubiertas de este producto o de los dispositivos acoplados.

Instrucciones de conexión	Instrucciones de desconexión
1. Apague todos los componentes (OFF).	1. Encienda todos los componentes (ON).
2. En primer lugar, conecte todos los cables a los dispositivos.	2. En primer lugar, retire los cables de alimentación de las tomas.
3. Conecte los cables de señal a los receptáculos.	3. Retire los cables de señal de los receptáculos.
4. Conecte los cables de alimentación a las tomas.	4. Retire todos los cables de los dispositivos.
5. Encienda el dispositivo (ON).	



caution:

Al cambiar la batería, utilice únicamente la batería IBM Número de pieza 36L9077 o un tipo de batería equivalente recomendado por el fabricante. Si el sistema tiene un módulo que contiene una batería de litio, sustitúyalo únicamente por el mismo tipo de módulo del mismo fabricante. La batería contiene litio y puede explotar si no se utiliza, manipula o desecha correctamente.

Lo que no debe hacer

- Tirar o sumergir el producto en agua.
- Exponer el producto a una temperatura superior a 100°C.
- Reparar o desmontar el producto.

Cuando quiera desechar la batería, siga las disposiciones y reglamentaciones locales.



caution:

Cuando instale una unidad de CD-ROM, tenga en cuenta la siguiente información.

Si se llevan a cabo controles o ajustes o se utilizan métodos que no se atengan a lo aquí especificado, se puede producir una exposición peligrosa a las radiaciones.

Si se retiran las cubiertas de la unidad de CD-ROM, se puede producir una peligrosa exposición a radiaciones de láser. Dentro de la unidad de CD-ROM no existen piezas reparables. No retire las cubiertas de la unidad de CD-ROM.

PELIGRO

Algunas unidades de CD-ROM tienen incorporado un diodo de láser de Clase 3A o de Clase 3B Tenga en cuenta la siguiente información.

Cuando la unidad está abierta se generan emisiones de rayos láser. No dirija la mirada al haz, no lo observe directamente con instrumentos ópticos y evite la exposición directa.



≥32 Kg ≥55Kg

caution:

Alce la máquina con cuidado; el sobrepeso podría causar alguna lesión.



caution:

La corriente eléctrica de los cables de comunicaciones, de teléfono y de alimentación puede resultar peligrosa. Para evitar posibles lesiones o daños del aparato, desconecte los cables de alimentación, los sistemas de telecomunicaciones, las redes y los módems antes de abrir las cubiertas del servidor, salvo que se indique lo contrario en las instrucciones de las operaciones de instalación y configuración.

Laser Compliance Statement

The CD/DVD-ROM drive in the computer is a laser product. The CD/DVD-ROM drive's classification label (sample shown below) is located on the drive.



The CD/DVD-ROM drive is certified in the U.S. to conform to the requirements of the Department of Health and Human Services 21 Code of Federal Regulations (DHHS 21 CFR) Subchapter J for Class 1 laser products.

In other countries, the drive is certified to conform to the requirements of EN60825.

Class 1 laser products are not considered to be hazardous. The CD/DVD-ROM drive has an internal Class 1, 0.5-milliwatt, aluminum gallium-arsenide laser that operates at a wavelength of 760 to 810 nanometers.

The design of the laser system and the CD/DVD-ROM drive ensures that there is no exposure to laser radiation above a Class 1 level during normal operation, user maintenance, or servicing conditions.

Trademarks

The following are trademarks of the IBM Corporation in the United States or other countries or both:

Operating System/2	OS/2
AT	Personal System/2
HelpCenter	PS/1
IBM	PS/2

Intel, Pentium, MMX, EtherExpress, and LANDesk are trademarks or registered trademarks of Intel Corporation.

Microsoft, MS-DOS, Windows, and Windows NT are trademarks or registered trademarks of Microsoft Corporation.

Other company, product, and service names may be trademarks or service marks of others.

Preface

This manual contains service information for the **Service Level A (SL-A)** model of the IBM Personal Computer, worldwide.

This manual is intended to be used as a stand-alone document to service Machine Types 6266, 6270, 6276, 6280 and 6286 product. It is divided into the following chapters:

Notices contains important safety information and notices required to service this computer.

General Information contains a brief description of this manual.

Check Procedures provide step-by-step instructions that aid in locating the failure Field Replaceable Unit (FRU).

Diagnostic Aids explain how to use the diagnostics tools for isolating failures.

Repairing Information contains illustrations and descriptions to disassemble and reassemble the computer.

Parts/Test Point Locations contains illustrations and descriptions of the locations of the major parts, jumpers, and connectors.

Safety Inspection Guide contains information about inspecting a machine for safety problems before putting the machine under a Maintenance Agreement.

Parts Catalog contains descriptions, illustrations, and part numbers for individual FRUs.

Appendix A, FRU Number Index contains part numbers listed in numerical order.

Index contains specific terms and words in alphabetical order.

General Information

General Information	27
Introduction	28
Product Overview	29
CMOS Reset	33
Flash (BIOS/VPD) update procedure	34
Working with the Setup Menus	35
Advanced Setup	38
Power Management Setup	39
ISA Legacy Resources	39
System Security	39
Specifications	41
Operating Requirements	42
Special Tools	43

Introduction

This chapter gives a general overview of Machine Types 6266, 6270, 6276, 6279, 6280 and 6286, describing the standard and optional features and details functional and environmental specifications. Machine Types 6266 and 6286 are desktop models and 6270, 6276, 6279 and 6280 are micro tower models.

Product Overview

All Machine Types mentioned above contain three PCI slots, and the system boards support the Intel processors.

Listed below are system features:

Processors (Machine Types 6266, 6270, 6276, 6279, 6280 and 6286)

- Socket 370
- Detachable fansink with only a heatsink on some Celeron models
- One of the following processors:
 - Intel Celeron 566 MHZ CPU
 - Intel Celeron 600 MHZ CPU
 - Intel Celeron 633 MHZ CPU
 - Intel Celeron 667 MHZ CPU
 - Intel Celeron 700 MHZ CPU
 - Intel Celeron 733 MHZ CPU
 - Intel Celeron 766 MHZ CPU
 - Intel PIII 733 MHZ CPU
 - Intel PIII 800 MHZ CPU
 - Intel PIII 866 MHZ CPU
 - Intel PIII 933 MHZ CPU
 - Intel PIII 1GHZ CPU

Memory

- 128-KB Pipeline Burst Static RAM (PBSRAM) for Celeron. Fixed onboard.
- 256-KB Pipeline Burst Static RAM (PBSRAM) PIII. Fixed onboard.
- 168-pin synchronous dynamic random access memory (SDRAM), dual inline memory module (DIMM) sockets.
 - 2 memory sockets.
 - 32-MB, 64-MB, 128-MB or 256-MB DIMM.
 - Maximum memory is 512MB.

External Ports

- VGA port (DB 15-pin connector)
- Parallel port (25-pin D-sub connector)
- 2 Serial ports (9-pin D-sub connector)
- Keyboard port (6-pin PS/2 mini-din connector)
- Mouse port (6-pin PS/2 mini-din connector)
- Two USB ports
- Mic connector
- Line Out (connectors for speakers or Headphones)
- Line In (used for external CD player, tape player, or other audio devices.)

Diskette Drive

- AT-type
- 3.5-in. 1.44MB slimline diskette drive.

Hard Disk Drive

- 3.5-in., 1-in. height IDE AT drive.
- 512 KB cache buffer in hard disk drive.
- Average and minimum 11.1 ms seek time, access time varies for the hard disk drive and the hard disk drive manufacturer.

CD-ROM Drive

- 5.25-in. high-performance, 48X CD-ROM IDE/AT drive.
- Read data and play audio from standard and mini CD-ROM and audio compact discs (audio CDs).

Multimedia

- One Internal Buzzer.

Power Management

- Compliant to ACPI and supports display power management signaling (DPMS) monitor.
- ACPI BIOS Mode if:
 - Your operating system supports ACPI.
 - When ACPI BIOS Mode is enabled, the operating system is allowed to control the power management features of your computer.
- APM BIOS Mode if your operating system supports APM enabled machines.
- Automatic Power On: this option lets you enable and disable features that automatically turn on your computer.

Note: For additional information about power management, see “Power Management Setup” on page 39.

Power Supply

- 95W power supply
- 155W power supply
- Standard ATX power supply.

Internal Cabling

- 40-pin ribbon cable for CD-ROM and ATA-66 cable for hard disk drive.
- One 34-pin ribbon cable for AT diskette drive.
- One 4-pin (2-wire) cable for hard disk drive light-emitting diode (LED).
- One 3-pin (3-wire) cable for power light-emitting diode (LED).
- One 2-pin (2-wire) cable for power switch.
- One 16-pin game port cable.

Modem

- 56.6 Kbps PCI Plug and Play modem adapter card with data/fax features.
- Telephone line-out (RJ-11) connector (Not available for all models).
- Telephone line-in (RJ-11) connector.

Keyboard (Keyboard is Geography/Model dependent.)

- PS/2 104-key rubber dome IBM Keyboard with 1.8-m (5.8-ft) cable.
- Rapid Access II Keyboard with 104 keybuttons.

Mouse

- 2 button mouse connected to the mouse port with 1.8-m (5.8-ft) cable.
- ScrollPoint II mouse.

Hardware Interfaces

The following peripheral interfaces for adapters, options, and drives are supported in the system unit.

Table 1-1 System Board Hardware Interfaces	
Item	Interface
Expansion slot for I/O adapter cards	Three PCI (peripheral component interconnect) v2.1 compatible expansion slots that operate at 33 MHz bus speed. PCI slot 1 can hold a short (175mm) PCI adapter card. PCI slot 2 can hold a PCI adapter card measuring 165 mm in length (or less). PCI slot 3 can hold a PCI adapter card measuring 236 mm in length (or less). The desktop model (machine types 6266 and 6286) only supports low profile PCI interface. (169mm) and The Fire Fly E2 model (machine types 6270, 6276, 6279 and 6280).
Hard Disk Drives	Two PCI local bus Enhanced IDE v1.0 compatible hard disk drive interfaces that support PIO mode up to mode 4, DMA 32-bit access up to mode 2 and Ultra 33 Synchronous DMA up to mode 2 (33M bytes/sec).
CD Drive	5.25-in. high-performance, forty eight speed (48X) CD-ROM IDE/AT drive Support Bootable CD-ROM Format specification version 1.0. Compliant to Audio-CD, Video-CD, CD-ROM/XA, Karaoke-CD, and Photo-CD (both single and multi-session) format.
Diskette Drive	AT diskette interface
Video	Physical interface is compatible with the IBM Personal System/2 (PS/2) VGA interface and Intel 810e VGA on board.
Modem	One 56.6 Kbps PCI Plug and Play modem adapter card with data/fax features.
Audio	All models use ADI Codec.
Pointing device	IBM PS/2-compatible mouse
Keyboard device	IBM PS/2-compatible keyboard
2 Serial ports	9-pin connector with RS232D electrical interface
Parallel port	Supports SPP (IBM PC/AT, PS/2) compatible, EPP (IEEE 1284 compliance), ECP (IEEE 1284 compliance) interface.
USB	USB controller integrated in core logic chip set.

CMOS Reset

This system does not deny access to the BIOS Setup Utility. Execute "Load BIOS Default Settings" in BIOS Setup to clear the corrupted CMOS data. See "Loading Default Settings" on page 36.

Flash (BIOS/VPD) update procedure

1. Power-off the computer.
2. Insert the flash update diskette into drive A.
3. Power-on the computer.
4. When the Update Utility appears; select the country/keyboard, and then press Enter.
5. If the computer serial number was previously recorded, the number is displayed with an option to update it. Press **Y** to update the serial number.
6. Type the 7-digit serial number of the computer you are servicing, then press Enter.
7. Follow the instructions on the screen to complete the flash (BIOS/VPD) update procedure.

Attention: Refer to the information label located inside the system unit cover for any model-specific information.

BIOS Setup Utility

The Setup Utility lets you review and change important information about the computer and its hardware.

Working with the Setup Menus

Starting the Setup Utility

Follow these steps to enter Setup when the computer is off:

1. Turn on your monitor.
2. Turn on the system unit.
3. When you see the IBM logo, press **F1** to enter Setup and display the Main Menu.

Refer to the Setup Utility Main Menu below.

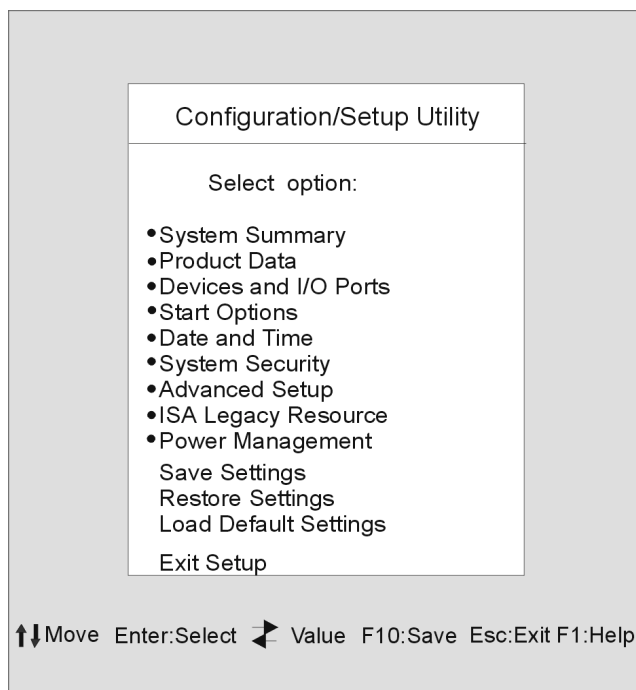

The following table lists specific keys on the keyboard that will help you move through the Setup menus:

Keys	Function
Down- or up-arrow key	Use these arrow keys to highlight an option on the menu. (Press the Enter key to choose the option.)
Left- or right-arrow key	Use these arrow keys to make a selection and change an option's setting. In some menus, you can use these keys to move from one field to another.
F1	Press this key if you want help for a selected item in a menu.
Esc	After viewing or making changes to the settings on a menu, press this key to exit the menu.
Enter	Press this key to choose a highlighted option from a menu.

Changing Parameter Settings

In the Setup menus, the configuration information that you can change is enclosed in brackets like these: []. You cannot change any information that is not enclosed in brackets. Use the up- or down-arrow keys to highlight options then press Enter to display a menu. When changing the setting of a particular parameter, highlight the setting then use the left- or right-arrow key to change the setting.

Loading Default Settings

When you purchase an IBM personal computer, it is already configured for use. The original configuration settings, also called factory or default settings, are stored in the CMOS. Setup includes an option Load Default Settings that allows you to reload the original configuration at any time.

If you have made changes in Setup but would like to restore the default settings, follow these steps:

1. From the main menu, highlight the option Load Default Settings then press Enter. A dialog box appears confirming if you want to load the default settings.
2. Type **Y** to select YES, then press **Enter**
3. Highlight the option **Save & Exit Setup**, then press **Enter**.
4. Type **Y** to select Yes, then press **Enter** to save the changes in CMOS.

You must load the Setup default settings in the following instances:

- When you replace the system battery
- When you customize your system configuration settings and some resource assignments conflict causing the computer to hang.

Exiting Setup (Save & Exit Setup/Exit Without Saving)

Press Esc to return to the main menu when you have finished viewing settings and making changes. From this location, you can exit Setup and save your changes or exit without saving your changes.

Follow these steps to exit Setup:

1. From the main menu, press the **Esc** key.
2. The Exit Setup dialog box appears saying Quit Without Saving (Y/N)? Type **Y** if you want to quit directly.

You also can Exit the Setup via highlighting the **Save & Exit Setup** option or **Exit without Saving** option and follow the dialog box directions.

Viewing system information and product data

To view general hardware information about your computer, select the **System Summary** option from the Configuration/Setup Utility menu. The items displayed in the System Information menu are not configurable.

Setup automatically updates this menu when you do either of the following:

- Add or change hardware on your computer
- Make changes to other menus in Setup and save those changes

To view the computer information such as the model number, serial number, and BIOS version and date, select the **Product Data** option from the Setup main menu. The items displayed are not configurable.

Devices and I/O ports

The options in this menu item are used to configure the devices and I/O ports that this system has.

Mouse

This setting allows you to select whether or not a mouse is installed.

Diskette Drive A

Determines the type of Diskette Drive A.

Serial Port Setup

Determines the I/O port address and Interrupt Request Number of 2 serial ports.

Parallel Port Setup

Determines the I/O port address and the Interrupt Request Number of parallel port.

USB Setup

Use these settings in this menu item to enable or disable the Universal serial Bus (USB) functions.

USB Support

Select enabled if you will be using USB devices.

USB Keyboard / Mouse Support

Select **Autodetect** if you want this support **enabled**. The USB Support must also be set to enabled before you use USB /Keyboard Mouse Support. Select **disabled** if you will not be using a USB Keyboard /Mouse.

IDE Drives Setup

Use these settings to view the hard disk and CD-ROM drives that are installed in your computer.

Your computer will show the size and selectable performance of a hard disk drive when it is installed. To get better performance, run IDE hard disk and CD-ROM drives in High Performance Mode.

Video setup

Select this menu item to configure the video settings.

Select Active Video

Select active video mode when the computer is started. If the selected video is not available, the computer will select a default video.

Palette Snooping

Select enabled if an ISA video multimedia adapter is installed in your computer and incorrect colors are displayed on the screen and your system has a PCI video adapter installed that supports Palette Snooping.

Video Interrupt

Select enabled if you are using an application that requires this support.

Audio Support

Use this setting to enable or disable the Audio function if your computer has the audio feature.

Network Setup

Use this setting to enable or disable the Network function.

Start options

The start options are settings that affect the way your computer acts when started.

Startup Sequence

Your computer can be started from several devices, including the hard disk drive, diskette drive, and CD-ROM drive.

Primary Startup Sequence

Use this setting to view or change the sequence.

Automatic Power On

Select **enabled** to use the startup sequence if your computer is started using automatic power on function.

Error Startup Sequence

You can set a device for this option. Select **Primary** if you want the system to bypass the Configuration/Setup Utility menu and a different startup sequence when a post error occurs.

Virus Detection

This setting allows you to determine whether or not you want the virus checker that comes with your system's BIOS to check each time when you turn on your computer. Select **enabled** to use this function. The BIOS will halt the system and a message will appear to warn that your computer may have a virus.

If necessary, you need to run an anti-virus program to locate and remove the program before any damage is done.

Keyboard Num Lock State

Determines the default state of the numeric keypad.

Keyboard Speed

Determines whether or not the speed at which the keyboard responds when you hold down a key. The default typematic rate is 30 characters per second (Fast Rate).

Disketteless Operation

The computer will startup and run without a keyboard if you select enabled.

Power On Self-Test

Determines the level of power on self-test (Quick or Enhanced) that will be done during the power on sequence. Select Quick to run a shortened power on self-test (POST) each time you turn on your computer.

Power On Logos

Determines whether or not logos are displayed during the power on sequence.

Network Boot F12 Option

Determines whether or not to boot from Network after the system is turned on by pressing F12.

Power On Status

Determines whether or not the power on indicators are displayed during the power on sequence.

Date and Time

Use this setting to set the date and time in your computer.

Advanced Setup

Use these features to configure advanced hardware features.

Cache Control

Use this setting to enable or disable the internal and external processor Cache. Overall system performance improves when cache is enabled.

ROM Shadowing

Determines whether or not video BIOS will be copied to RAM. Video performance improves when cache is enabled.

PCI Control

Select **enabled** if you want your computer to have a PCI parity check of data across the PCI bus.

Plug and Play Control

Use the option to configure settings for Plug and Play devices.

Set Device Code

Most Plug and Play adapters use 16-bit address decoding. If you are experiencing problems with a Plug and Play adapter, changing address to decoding to 10-bit might fix the problem.

Address Decode

Select **Yes** if you are experiencing post errors numbered 185X and your system will be booting from a Plug and Play compliant operating system.

Plug and Play Operation System

By default, the setting is disabled. If you configure this selection, the machine must be powered off and back on for the change to take effect.

ISA Legacy Resources

ISA legacy resources (DMA, Interrupts, Memory) are resources that used by ISA adapters which are not Plug and Play adapters. As this computer supports PCI adapter cards only, this setting has no useful purpose.

Power Management Setup

The Power Management Setup allows you to configure your system to most effectively save energy while operating in a manner consistent with your own style of computer use.

ACPI BIOS Mode

Use this setting to enable or disable the Automatic Configuration and Power Interface (ACPI). If your operationg system supports ACPI BIOS Mode, it is allowed to control the power management features of your computer when ACPI BIOS Mode is enabled.

APM

This setting allows automatic power saving through monitoring of your computer's hardware.

APM BIOS Mode

Select **enabled** to reduce power consumption during periods of hardware inactivity.

Activity Monitor

Use this setting to set up the system activities that you want monitored for automatic power management.

Automatic Power On

Use this setting to define automated methods of waking up the computer:

- Wake up when the modem senses an incoming ring.
- Wake up at a preset time.
- Wake up from PCI devices that supports this function.

System Security

Use this setting to configure the system security settings for your computer.

Security Profile by Device

This setting allows you to control which devices require a password before they start up. You can set the below devices to request a password before they start up:

- Removable Media Devices
- Hard Disk Devices
- Network Devices.

Remote Administration

Select enabled to allow Remote Administration to be run from a remote system without requiring entry of your administrator password.

Power-On Password

This option allows you to set, change, or delete a power-on password.

Administrator Password

This option allows you to set, change, or delete an administrator password.

Adapter ROM Security

If **Yes**, the keyboard will be locked during adapter ROM initialization. This can be used in conjunction with an administrator password to prevent the use of adapter ROM based on utilities.

Specifications

Dimensions (width x depth x height):

- System unit:
 - For machine types 6266 and 6286
 - 305 mm (12.45 in.) x 380.4 mm (14.97 in.) x 88 mm (3.46 in.)
 - For machine types 6270, 6276, 6279 and 6280:
 - 192 mm x 338 mm x 353 mm .

Weight:

- System unit:
 - For machine types 6266 and 6286:
 - 8.5 kg (18.72 lb)
 - For machine types 6270, 6276, 6279 and 6280:
 - 9.3 kg

Environment:

- Temperature for system unit:
 - Power on: 10° to 35°C (50° to 95°F)
 - Power off: -20° to 60°C (14° to 140°F)
- Humidity for system unit:
 - Power on: 8% to 80%
 - Power off: 8% to 80%
- Altitude for system unit:
 - 7,000 feet

Power consumption:

- System unit:
 - Maximum: 95-watts

Electrical input:

- Input voltage for system unit (Sine-wave input is required) :
 - Low Range: 100 V ac to 127 V ac
 - High Range: 200 V ac to 240 V ac

Operating Requirements

All machines require two power inputs: one on the system unit and one on the monitor display.

The system unit comes with a voltage selector switch, allowing selection of either 115 V ac or 230 V ac. This switch must be in the 230 V ac position when the machine is plugged into a 230 V ac electrical outlet.

Special Tools

The following special tool is required to service this system when running the diagnostics program (PC-Doctor):

- Wrap plug, P/N 72X854

CheckProcedures

Check Procedures	45
Introduction	46
Start	47
Index of Symptoms, Messages, Error Codes, or Beeps	50
Troubleshooting	59
Factory-Installed Storage Devices	60
Factory-Installed Modem Card	61
Audio (Not Supported by Diagnostics Program)	62
CD-ROM Drive	63
Memory	64
Keyboard	64
Mouse	65
Power Supply	66
Monitor	68
Undetermined Problems	69

Introduction

This chapter contains the check procedures used to diagnose the causes of product failures. The diagnostic information consists of:

Start: This is the starting point for any diagnostic action. Based on high-level symptoms, the check procedure directs you to more detailed procedures to help resolve machine failures.

Index of Symptoms, Messages, Error Codes, or Beeps: The tables for BIOS Error Messages, Codes, Beeps, and Error Symptoms list symptoms along with their probable causes, and direct you to the applicable check procedures to help resolve machine failures. These tables also list the field replaceable units (FRUs) most likely to cause a particular problem.

Check Procedures: When the Start check procedure or the Index of Symptoms, Messages, Error Codes, or Beeps tables point you to a specific check procedure, proceed to that section. If there are any notes or instructions at the top of the page, read them before you begin with the procedure. Carefully read each step of the check procedure and perform the steps as instructed. If you do not remember the location of a specific part or test point, or an adjustment or removal procedure, see the chapter that contains that information. Always return to the check procedure after you do this. In some cases, you are referred to other check procedures to detect the cause of the failure.

Start

This is the entry point for all check procedures. The check procedures use failure symptoms, Power-On Self Test (POST) error codes, or beeps to help determine the defective field replaceable unit (FRU). Follow the suggested check procedures or use the diagnostics diskette to determine the problem FRU.

IMPORTANT: Replace FRUs ONLY when it is determined that the error is not a result of software, loose contacts, or dirty component surfaces. Any FRU change should be verified by running a complete test (**Diagnostics - All Tests** in PC-Doctor diagnostics program).

This book comes with a diagnostic program diskette. This diskette should be used ONLY with **Machine Types 6266, 6270, 6276, 6279, 6280 and 6286**. Do not use this diskette on other models.

POST error codes and error messages are displayed on the screen after the IBM logo.

A beep will precede each error code or message. Please refer to "Index of Symptoms, Messages, Error Codes, or Beeps" on page 50 for additional help.

All voltages in the check procedures are positive unless otherwise indicated. Use frame ground for all voltage checks unless otherwise specified.

IMPORTANT: There is a voltage selector on the rear panel of the machine. Use a flat-head screwdriver to turn the voltage selector to the voltage setting for the area in which you will be using the system.

NOTE: If the check procedures instruct you to replace a FRU and the error message persists, an option adapter card might be causing the failure. Remove all option adapter cards, one at a time, until the error changes or the problem is no longer apparent. The problem may be in the last card that you removed or something associated with it.

The Recovery CD contains pre-loaded software that may reinstall the original software and recover the system. Ensure that any data and programs on the hard drive have a backup copy.

How to Diagnose Combined FRUs: If an adapter or device consists of more than one FRU, any of the FRUs might cause an error code. Before replacing the device or adapter, remove the FRUs one by one to see if the symptoms change.

If a newly replaced FRU does not correct the problem:

If you have reached this point of the check procedures and were instructed to replace a FRU but doing so did not correct the problem, reinstall the original FRU and go through "Start" again.

If you want to print a copy of a BIOS Setup Utility screen to an attached printer, press **Print Screen** key, while the screen is displayed.

PLEASE READ THE FOLLOWING:

Human Error is a cause for concern when applied to check procedures. It exists in every first time set of analysis procedures. It is therefore essential for effective and time-efficient servicing that each stage of every procedure be verified. (For example: When a symptom is found, or when a symptom appears to have been cured; the preceding steps should be repeated for accuracy of analysis.)

001 - START

To begin, note the following:

- Disable the setting of "Quick Power-On Self Test" from BIOS Setup.
- Disconnect all external cables and devices including speakers and microphone from the system unit, except for the keyboard, mouse, and monitor.
- Power off the system unit before moving it or when replacing FRUs.
- Remove all adapter cards, except for the factory-installed modem adapter card and any other IBM factory-installed adapter cards.
- Disconnect any drives except:
 - 3.5-in. diskette drive
 - Hard disk drive
 - Factory-installed devices (such as a CD-ROM drive)
- Make sure that all power cords and cables are connected properly.
- Make sure that the monitor brightness and contrast controls are not turned down.
- Power on the system unit.

NOTE: Some monitors have a detachable system I/O signal cable between the monitor and the system unit. In this case, check this signal cable before replacing the unit. See "Monitor Port Signals" on page 111 for pin identification.

- Make sure that the monitor refresh rate is correct.
- Note any symptoms, messages, error codes, or beeps.
- Make sure that there are no diskettes or CDs in the drives.

002 - DOES AN IBM LOGO SCREEN APPEAR? (YES, READ AHEAD. NO, GO TO STEP 004.)

- Insert the diagnostics diskette in the diskette drive.

003 - DOES SYSTEM LOAD THE DIAGNOSTICS PROGRAM FROM THE DISKETTE DRIVE? (YES, READ AHEAD. NO, GO TO STEP 004.)

- Follow the instructions on the screen and select **Utility** from the diagnostics program menu.
- Select **Tech Support Form** from the menu, press F5 to execute, then generate a system configuration report.
- Compare the system configuration list with the actual devices installed in system.

NOTE: If necessary, remove the machine cover and visually compare the devices installed in system to those shown in the system configuration report.

- Go to step 006.

004 - DO ANY MESSAGES, ERROR CODES, OR SYMPTOMS APPEAR? (YES, READ AHEAD. NO, GO TO STEP 005)

- Go to "Index of Symptoms, Messages, Error Codes, or Beeps" on page 50.
- End.

005 -

- If the keyboard responds incorrectly, go to "Keyboard" on page 64.

006 - DOES THE SYSTEM CONFIGURATION REPORT CORRECTLY IDENTIFY THE DEVICES INSTALLED IN SYSTEM? (YES, READ AHEAD. NO, GO TO STEP 007.)

- Select **Diagnostics** from the diagnostics program menu.
- Select and execute **All Tests**.
- Go to step 008.

007 -

The system configuration report shows only those devices supported by the diagnostics diskette.

If a device is missing from the list and is not factory installed, refer to the service manual provided for that device.

008 - DOES THE DIAGNOSTICS FINISH WITHOUT ANY ERRORS? (YES, READ AHEAD. NO, GO TO STEP 009.)

- If the **Diagnostics \ All Tests** did not detect a failure but the system still indicates a failure:
- Check all adapter card jumper settings.
- Check all adapter cards switch settings.
- Check all adapter card cables and connectors.
- Make sure that all of the above are set correctly and show the correct voltages and continuity. Replace any defective cables or adapter cards. See "Power Supply Cable Connector Specifications" on page 103 and "Layout of System Board of Machine Types 6266, 6270, 6276, 6279, 6280 and 6286" on page 101.
- Run the Diagnostics \ All Tests again.
- If an error or other symptom is displayed, go to "Index of Symptoms, Messages, Error Codes, or Beeps" on page 50.
- If no error can be detected or the symptom is intermittent, go to "Undetermined Problems" on page 69.
- End

009 -

- If the last test stops and you cannot continue, first make sure all switches, power connectors, cables, and jumpers are set correctly and show the correct voltages and continuity.
- Take note of any messages, error codes, beeps, or new symptoms. Go to "Index of Symptoms, Messages, Error Codes, or Beeps" on page 50.
- If there is no error symptom or the error symptom is intermittent, go to "Undetermined Problems" on page 69.

Index of Symptoms, Messages, Error Codes, or Beeps

How to Use Error Messages: Use the messages, error codes, and beeps combinations that occur to diagnose failures. If more than one failure occurs, diagnose from the first failure that appears. The cause of the first failure can result in false messages, error codes, or beeps. If you did not receive any messages, error codes, or beeps, see if the symptom is listed in Table 2-3, "Error Symptoms List" on page 54.

ATTENTION: When you have replaced a FRU, you must run the diagnostics to ensure that no other activity has been affected by the change. This system check can be done through the diagnostics program (Select **Diagnostics**, then select and execute **All Tests** from PC-Doctor).

POST: Some diagnostic aids are resident in the machine, such as the Power-On Self Test (POST). The machine performs the POST each time it is powered on. Use this information throughout the diagnostic procedures. The POST is a series of system checks and initializations that verify the correct operation of the base system.

After a successful POST, the system attempts to load the operating system. The system can be customized for different startup (boot) methods by the BIOS Setup Utility. See "**Advanced Setup**" on page 38.

The system's default startup sequence automatically looks for the operating system files in the hard disk if these files are not found in the diskette.

NOTE: Remember that POST does not test all areas, but only those that allow the system to operate well enough to run the diagnostics program.

Table 2-1 lists BIOS error codes, messages, and beeps to their possible causes, table 2-3 lists error symptoms and their possible causes. The most likely cause is listed first. Make sure you complete all items in the cause or "Action/FRU" column. When servicing a system, always begin with "Start" on page 47.

If the problem cannot be corrected using these two index tables, go to "Undetermined Problems" on page 69.

NOTES:

If an error message and incorrect audio response occur, diagnose the error message first.

If you cannot run the diagnostics program tests but did receive a POST error code, diagnose the POST error message.

If you did not receive any error message, look for a description of your error symptoms in "Error Symptoms List" in page 54.

1. Check all power supply voltages, switch, and jumper settings before you replace the system board. Also check the power supply voltages if you have a "system no-power" condition. ("Power Supply Cable Connector Specifications on page 103 and Layout of System Board of Machine Types 6266, 6270, 6276, 6279, 6280 and 6286 on page 101).
2. If the problem cannot be corrected by using the "BIOS Error Codes, Messages, And Beeps List" table and "Error Symptoms List" table, go to "Undetermined Problems" on page 69.

Table 2-1 BIOS Error Codes, Messages, and Beeps List	
BIOS Error Codes, Messages, beeps	Action/FRU
NOTE: To diagnose a problem, first find the BIOS error messages, codes, or beeps in left column. If directed to a check procedure, replace the FRU indicated in the check procedure. If no check procedure is indicated, the first Action/FRU listed in right column is the most likely cause.	
POST Error Codes and Messages	
161 CMOS battery failed	Load default settings in Setup and reboot the system. CMOS battery. System board.
162 CMOS checksum error	Make sure the equipment (diskette drive, hard disk drive, keyboard, mouse, etc.) is connected properly and are set correctly in BIOS Setup. Load default settings in setup. CMOS battery should be replaced. System board.
164 Memory size error	Make sure the DIMMs are inserted properly. System board.

Table 2-1 BIOS Error Codes, Messages, and Beeps List

BIOS Error Codes, Messages, beeps	Action/FRU
<p>NOTE: To diagnose a problem, first find the BIOS error messages, codes, or beeps in left column. If directed to a check procedure, replace the FRU indicated in the check procedure. If no check procedure is indicated, the first Action/FRU listed in right column is the most likely cause.</p>	
<p>201 Memory test failure.</p>	<p>Insert the memory modules in the DIMM sockets properly, and then reboot the system. Memory module. See the "Step 005" of "Memory" on page 64 to replace memory module. System board.</p>
<p>301 Keyboard error or no keyboard present.</p>	<p>Make sure the keyboard is connected properly and are set correctly in BIOS Setup. System board.</p>
<p>662 FLOPPY DISK(S) failure (80)</p>	<p>Unable to reset floppy subsystem.</p>
<p>662 FLOPPY DISK(S) failure (40)</p>	<p>Floppy Type mismatch.</p>
<p>1701 Hard disk(s) Diagnosis failure</p>	<p>Make sure the hard disks are set correctly in BIOS setup. Hard disk drive cable/connection. Hard disk drive. System board.</p>
<p>1762 Primary master IDE has changed Primary slave IDE has changed Secondary master IDE has changed Secondary slave IDE has changed</p>	<p>Make sure that the System Boot Drive parameter in the Startup Options of BIOS Setup is not set to [Drive A only]. Load default settings in Setup. Insert a system diskette into diskette drive and reboot system. Make sure the diskette drive configuration setting in BIOS Setup is correct. Hard disk drive power. Diskette drive. System board.</p>
<p>1780 Primary master hard disk failure 1781 Primary slave hard disk failure</p>	<p>A warning message to indicate there has been a change of IDE Primary (Secondary) Channel Master (Slave) device. Load default settings in Setup. Check IDE drive jumper. See "3.5-In. Hard Disk Drive Jumper Locations" on page 107. IDE drive power. IDE drive cable/connection. IDE drive.</p>
<p>1782 Secondary master hard disk failure 1783 Secondary slave hard disk failure</p>	<p>A warning message to indicate there has been a change of IDE Primary (Secondary) Channel Master (Slave) device. Load default settings in Setup. Check IDE drive jumper. See "3.5-In. Hard Disk Drive Jumper Locations" on page 107. IDE drive power. IDE drive cable/connection. IDE drive.</p>
<p>8602 Mouse error on no Mouse present</p>	<p>Make sure the Mouse is connected properly and is set up correctly in BIOS Setup. Mouse. System board.</p>
<p>SYSTEM HALTED, (CTRL-ALT-DEL) TO REBOOT...</p>	<p>Indicates the present boot attempt has been aborted and the system must be rebooted. Press and hold down the CTRL and ALT key and DEL.</p>
<p>Hard Disk(s) failure (80)</p>	<p>Hard Disk Drive reset failed.</p>

Table 2-1 BIOS Error Codes, Messages, and Beeps List	
BIOS Error Codes, Messages, beeps	Action/FRU
NOTE: To diagnose a problem, first find the BIOS error messages, codes, or beeps in left column. If directed to a check procedure, replace the FRU indicated in the check procedure. If no check procedure is indicated, the first Action/FRU listed in right column is the most likely cause.	
Hard Disk(s) failure (40)	Hard Disk Drive controller diagnostics failed.
Hard Disk(s) failure (20)	Hard Disk Drive initialization error.
Hard Disk(s) failure (10)	Unable to recalibrate fixed disk.
Non-System disk or disk error Replace and strike any key when ready	Insert a system disk into Drive A: and press <Enter>. If you assumed the system would boot from the hard drive, make sure the controller is inserted correctly and all cables are properly attached. Be sure the disk is formatted as a boot device. Then reboot the system.
OFFENDING SEGMENT:	This message is used in conjunction with the I/O CHANNEL CHECK and RAM PARITY ERROR messages when the segment that has caused the problem has been isolated.
PRESS A KEY TO REBOOT	This will be displayed at the bottom of the screen when an error occurs that requires you to reboot. Press any key and the system will reboot.
PRESS F1 TO DISABLE NMI, F2 TO REBOOT	When BIOS detects a Non-maskable Interrupt condition during boot, this will allow you to disable the NMI and continue to boot, or you can reboot the system with the NMI enabled.
RAM PARITY ERROR – CHECKING FOR SEGMENT ...	Indicates a parity error in Random Access Memory.
Memory parity Error at ...	Indicates a memory parity error at a specific location. You can use this location along with the memory map for your system to find and replace the bad memory chips.
Memory Verify Error at.	Indicates an error verifying a value already written to memory. Use the location along with your system's memory map to locate the bad chip.
OFFENDING ADDRESS NOT FOUND	This message is used in conjunction with the I/O CHANNEL CHECK and RAM PARITY ERROR messages when the segment that has caused the problem cannot be isolated.
ERROR ENCOUNTERED INITIALIZING HARD DRIVE	Hard drive cannot be initialized. Be sure the adapter is installed correctly and all cables are correctly and firmly attached. Also be sure the correct hard drive type is selected in Setup.
ERROR INITIALIZING HARD DISK CONTROLLER	Cannot initialize controller. Make sure the cord is correctly and firmly installed in the bus. Be sure the correct hard drive type is selected in Setup. Also check to see if any jumper needs to be set correctly on the hard drive.
FLOPPY DISK CNTRLR ERROR OR NO CNTRLR PRESENT	Cannot find or initialize the floppy drive controller. Make sure the controller is installed correctly and firmly. If there are no floppy drives installed, be sure the Diskette Drive selection in Setup is set to NONE.

Table 2-2 BIOS Error Codes, Messages, and Beeps List

BIOS Error Codes, Messages, beeps	Action/FRU
<p>NOTE: To diagnose a problem, first find the BIOS error messages, codes, or beeps in left column. If directed to a check procedure, replace the FRU indicated in the check procedure. If no check procedure is indicated, the first Action/FRU listed in right column is the most likely cause.</p>	
<p>Beeps</p>	
<p>(2: long, 1: short) 2-1-1 2- (repeatedly)</p>	<p>This code indicates that a video error has occurred and the BIOS cannot initialize the video screen to display any additional information. The code indicates that DRAM error has occurred. See "Memory (DIMM)" on page 88 to get more information.</p>

Table 2-3 Error Symptoms List

Error Symptoms	Action/FRU
<p>NOTE: To diagnose a problem, first find the error symptom in the left column. If directed to a check procedure, replace the FRU indicated in the check procedure. If no check procedure is indicated, the first Action/FRU listed in right column is the most likely cause.</p>	
<p>Processor</p>	
<p>NOTE: Normally, the processor fan should be operative, and the processor clock setting should be exactly set to match its speed requirement before diagnosing any processor problems.</p>	
<p>Processor fan does not run but power supply fan runs.</p>	<p>Make sure that the system is not in power saving mode. See "Power Management Setup" on page 39.</p> <p>With the system power on, measure the voltage of processor fan connector FN. (See "Power Supply Cable Connector Specifications on page 103 and refer to the connectors and Connectors and Functions of System Board of Machine Types 6266, 6270, 6276, 6279, 6280 and 6286 on page 102). Its readings should be +12Vdc.</p> <p>Processor fan. System board.</p>
<p>Processor test failed.</p>	<p>Processor. System board.</p>
<p>System Board</p>	
<p>NOTE: Ensure that the memory modules are installed properly and the contact lead is clean before diagnosing any system problems.</p>	
<p>Memory test failed.</p>	<p>"Memory" on page 64. System board</p>
<p>Incorrect memory size shown or repeated during POST.</p>	<p>Insert the memory modules in the DIMM sockets properly, and then reboot the system.</p> <p>Memory module. See the "Step 005" of "Memory" on page 64 to replace memory module. System board.</p>
<p>System works but fails to enter power saving mode when the "Power Management" is set to [Enabled], and power saving timer set in BIOS has elapsed.</p>	<p>Load default settings. In Win98, check settings in Control Panel Power utility. Reload software from Recovery CD.</p>
<p>System hangs before system boot.</p>	<p>"Index of Symptoms, Messages, Error Codes, or Beeps" on page 50. "Undetermined Problems" on page 69.</p>
<p>System hangs after system boot.</p>	<p>Execute a system test ("Diagnostics/All Tests" in PC-Doctor diagnostics program) and set it to stop at "Halt on Error" to see the potential cause of the problem. "Undetermined Problems" on page 69.</p>
<p>Blinking cursor only; system does not work.</p>	<p>"Start" on page 47. Diskette/IDE drive connection/cables Diskette/IDE disk drives "Undetermined Problems" on page 69. System board</p>
<p>Diskette Drive</p>	
<p>NOTE: Ensure that the diskette drive is configured correctly in BIOS Setup and its read/write head is clean before diagnosing any diskette drive problems.</p>	
<p>Media and drive are mismatched.</p>	<p>Make sure that the diskette drive is configured correctly in the Disk Drives of BIOS Setup. Make sure that the diskette drive is correctly formatted. Diskette drive connection/cable Diskette drive System board</p>

Table 2-3 Error Symptoms List	
Error Symptoms	Action/FRU
NOTE: To diagnose a problem, first find the error symptom in the left column. If directed to a check procedure, replace the FRU indicated in the check procedure. If no check procedure is indicated, the first Action/FRU listed in right column is the most likely cause.	
Diskette drive does not work.	Make sure that the diskette drive is not set to [None] in the "Standard CMOS Setup" of BIOS Setup. Diskette drive power Diskette drive connection/cable Diskette drive System board
Diskette drive test failed.	Diskette Diskette drive Diskette drive cable System board
Hard Disk Drive	
NOTE: Ensure hard disk drive is configured correctly in BIOS Setup, cable/jumper are set correctly before diagnosing any hard disk drive problems.	
Hard disk drive test failed.	Load default settings. Hard disk drive cable. Hard disk drive. System board.
Hard disk drive format error.	Load default settings. Hard disk drive cable. Hard disk drive. System board.
Hard disk drive write error.	Load default settings. Hard disk drive.
Hard disk drive LED fails to light, but system operates normally. With the system power on, measure the voltage of hard disk LED connector JFP1 (Please refer to "Connectors and Functions of System Board of Machine Types 6266, 6270, 6276, 6279, 6280 and 6286" on page 102).	
CD-ROM Drive	
NOTE: Make sure CD-ROM drive is configured correctly in BIOS Setup, cable/jumper are set correctly and its laser beam is clean before diagnosing any CD-ROM drive problems.	
CD-ROM drive LED flashes for more than 30 seconds before LED shutting off. Software asks to reinstall disc. Software displays a reading CD error.	CD may have dirt or foreign material on it. Check with a known good disc. CD is not inserted properly. CD is damaged.
CD-ROM drive LED doesn't come on but works normally.	CD-ROM drive

Table 2-3 Error Symptoms List

Error Symptoms	Action/FRU
<p>NOTE: To diagnose a problem, first find the error symptom in the left column. If directed to a check procedure, replace the FRU indicated in the check procedure. If no check procedure is indicated, the first Action/FRU listed in right column is the most likely cause.</p>	
<p>CD-ROM drive cannot load or eject when the system is turned on and its eject button is pressed and held.</p>	<p>CD-ROM drive power. "CD-ROM Drive" on page 63. CD-ROM drive</p>
<p>CD-ROM drive does not read and there are no error codes or messages are displayed.</p>	<p>CD may have dirt or foreign material on it. Check with a known good disc. Make sure that the CD-ROM driver is installed properly. CD-ROM drive.</p>
<p>CD-ROM drive can play audio CD but no sound output.</p>	<p>Make sure that the headphone jack of the CD-ROM has an output, then check if the audio cable from CD-ROM drive to system board CD audio connector is connected properly. Turn up the sound volume. Speaker power/connection/cable. CD-ROM drive.</p>
<p>Real-Time Clock</p>	
<p>Real-time clock is inaccurate.</p>	<p>Make sure that the information in the Date and Time of BIOS Setup is set correctly. Load default settings. RTC battery. System board</p>
<p>Audio</p>	
<p>Audio software program invokes but no sound comes from speakers.</p>	<p>Speaker power/connection/cable.</p>
<p>Video and Monitor</p>	
<p>Video memory test failed. Video adapter failed.</p>	<p>Remove all non-factory cards. Load default settings (if screen is readable). System board</p>
<p>Display problem: - Incorrect colors - No high intensity - Missing, broken, or incorrect characters - Blank monitor(dark) - Blank monitor(bright) - Distorted image - Unreadable monitor - Other monitor problems</p>	<p>Monitor signal connection/cable. Monitor System board</p>
<p>Display changing colors.</p>	<p>Monitor signal connection/cable Monitor System board</p>

Table 2-3 Error Symptoms List	
Error Symptoms	Action/FRU
NOTE: To diagnose a problem, first find the error symptom in the left column. If directed to a check procedure, replace the FRU indicated in the check procedure. If no check procedure is indicated, the first Action/FRU listed in right column is the most likely cause.	
Display problem not listed above (including blank or illegible monitor).	"Monitor" on page 68. Load default settings (if screen is readable). System board
Parallel	
NOTE: Execute "Load BIOS Default Settings" in BIOS Setup to confirm ports' presence before diagnosing any parallel/serial ports problems.	
Serial or parallel port loop-back test failed.	Make sure that the LPT# or COM# you test is the same as is set in BIOS Setup. Loop-back. System board.
Printing failed.	Make sure that the printer driver is properly installed. Refer to the service manual for the printer. Printer. Printer cable. System board.
Printer problems.	Refer to the service manual for the printer.
Joystick	
Game port does not respond or does not work.	Connect a joystick to the game port, then execute "Interactive Test/Joystick test" in PC-Doctor diagnostics program. System board.
Diagnostic Program	
Diagnostics programs cannot be executed.	Reboot the system from the diagnostics diskette. Load default settings. Diagnostics diskette. Memory module. System board.
Missing diagnostics files(s).	Diagnostics diskette.
Keyboard	
Some or all keys on keyboard do not work.	"Keyboard" on page 64.
Power Supply	
Pressing power switch cannot turn off system. (Only unplug power cord from electrical outlet can turn off system.)	See "Power Management Setup" on page 39. Power switch cable assembly "Power Supply" on page 66. System board
Pressing power switch cannot turn on system.	Check the voltage selector on the power supply if it is off. Power switch cable assembly.
Executing software shutdown from Windows98 Start menu cannot turn off system. (Only pressing power switch can force system to turn off).	Load default settings. Reload software from Recovery CD.
No system power or power supply fan is not running.	"Power Supply" on page 66. System board.

Table 2-3 Error Symptoms List

Error Symptoms	Action/FRU
NOTE: To diagnose a problem, first find the error symptom in the left column. If directed to a check procedure, replace the FRU indicated in the check procedure. If no check procedure is indicated, the first Action/FRU listed in right column is the most likely cause.	
Other Problems	
Any other problems.	"Undetermined Problems" on page 69.

Troubleshooting

Failing Parts or Assemblies: The check procedures generally help you trace a problem to one part or assembly. The last step of the specific check procedure you are using indicates that a part or assembly is failing. You should inspect the part or assembly before you decide to replace it. It might be loose, dirty, or in need of a small repair. The check procedures might lead you to two, or even three, possible failing parts or assemblies. The parts that might be failing are listed in order of the most probable failure. Also, the FRU parts are defined as replaced units and are not repaired in the field.

Measuring Voltages: Some check procedure steps instruct you to measure voltages on cable plugs and electronic board connectors. If you are asked to measure voltage at several places on a plug or connector, a chart next to or near the instruction indicates the number of the plug or connector, the pin numbers you should measure the signal name, and the correct voltage for the condition you are measuring. Measure the voltage only at the pins listed in the chart. Remember to set the meter on the correct scale and to put the meter leads in the correct position for the voltage you are asked to measure.

NOTE: Use frame ground as the ground reference. Attach the black (ground) lead of meter to frame ground, except where specified otherwise.

Factory-Installed Storage Devices

Use this check procedure to test any factory-installed drives.

ATTENTION: The customer may have customized settings in the Setup Utility (other than default settings) on the computer you are servicing. Running the Setup Utility might alter those settings. Take note of the current settings and verify that the customer settings are in place when service is complete.

NOTE: If you cannot access the hard disk drive or load a diskette from Drive A or load a CD from the CD-ROM drive, make sure that the BIOS Setup Utility has the startup sequence set with diskette, CD-ROM, and hard disk drives.

001 - START

- Insert the diagnostics diskette into the diskette drive.
- Power-off then power-on the system unit.

002 - DO ANY POST MESSAGES, ERROR CODES, BEEPS, OR SYMPTOMS OCCUR? (YES, READ AHEAD. NO, GO TO STEP 003)

- Go to "Index of Symptoms, Messages, Error Codes, or Beeps" on page 50.
- End.

003 -

- Select **Utility** from the menu.
- Select and execute **Tech Support Form** from the menu to generate a system configuration report.
- Compare the system configuration list with the actual devices installed in system.

NOTE: If necessary, remove the cover and visually compare the devices installed in the system unit to those shown in the Tech Support Form.

004 - IF THE NUMBER OF DISKETTE, HARD DISK, OR CD-ROM DRIVE IS NOT CORRECT, READ AHEAD; OR GO TO STEP 005.

- Check the cable installation of all disk drives.
- Diskette drive should be connected to the system board Floppy connector. (Please refer to "Connectors and Functions of System Board of Machine Types 6266, 6270, 6276, 6279, 6280 and 6286" on page 102).
- IDE Primary Channel Master and Slave Drives in BIOS Setup should be connected to the system board primary "Connectors and Functions of System Board of Machine Types 6266, 6270, 6276, 6279, 6280 and 6286" on page 102).
- IDE Secondary Channel Master and Slave Drives in BIOS Setup should be connected to the system board secondary IDE connector. (Please refer to "Connectors and Functions of System Board of Machine Types 6266, 6270, 6276, 6279, 6280 and 6286" on page 102).

NOTE: The CD-ROM drive that comes with system unit should be configured as IDE Secondary Channel Master device.

- Check the hard disk and CD-ROM drives jumper settings. See "3.5-In. Hard Disk Drive Jumper Locations" on page 107 and "CD-ROM Drive" on page 63.
- Check the voltages of all disk drive power connectors. See "Power Supply Cable Connector Specifications" on page 103.
- Correct the parameter settings under Disk Drives in the BIOS Setup. See "IDE Drives Setup" on page 37.
- In the BIOS Setup, check that the correct drive size is set for the flagged drive shown in the Installed Devices list.
- Load default settings.
- If the problem remains, check the continuity on the drive and the cable and replace it if necessary. If that does not fix the problem, replace the system board.
- End.

005 -

- Select **Diagnostics** from the PC-Doctor diagnostics program main menu. Select and execute **Floppy Disk Test** if you want to test the diskette drive. Select and execute **Hard Disk Test** if you want to test the hard disk drive.
- Select **Interactive Tests** from the PC-Doctor diagnostics program main menu, then select and execute **CD-ROM/DVD Test** if you want to test the CD-ROM drive.
- If the diagnostics program did not detect a failure, but the system still displays a failure:
- If an error or other symptom appears, go to "Index of Symptoms, Messages, Error Codes, or Beeps" on page 50.
- If no error can be detected or the symptom is intermittent, go to "Undetermined Problems" on page 69.
- End.

Factory-Installed Modem Card

001 - START

- Power off the system unit.
- In Windows 98 Device Manager, make sure that the modem is not configured with a conflicting COM port and IRQ setting.
- Make sure that the communication software is configured with the correct COM and IRQ settings (same COM port and IRQ as the modem).
- Make sure that all communication parameters (baud rate, data, stop and parity bits) are properly configured and are identical on both sides.
- Connect the phone line to the LINE port of the modem card.

NOTE: Check the outside phone line by connecting a working telephone to the telephone wall jack. Listen for a dial tone to ensure that the phone line is good.

002 -

- Insert the diagnostics diskette into the diskette drive.
- Power on the system unit.
- Select **Diagnostics** menu,
- Select **All Tests**, then execute **Modem** test.

003 - DOES THE MODEM PASS THE TEST? (YES, READ AHEAD. NO, GO TO STEP 004.)

- Power off the system unit.
- Remove all adapter cards.
- Connect a hard disk drive with pre-loaded Windows 98.
- Power on the system unit.
- Perform the following steps under Windows 98.

NOTE: If an operating system other than Microsoft Windows 98 is installed, the program screens and icons may differ from these instructions.

- 1. Start Microsoft Windows 98.
- 2. Select the **Start** icon.
- 3. Select **Program**, then select **Accessories**, **Hyper Terminal**.
- 4. Select an **on-line service station**, dial and connect to it.

004 - CAN THE MODEM DIAL OUT AND CONNECT TO ANY BBS SUCCESSFULLY? (YES, READ AHEAD. NO, GO TO STEP 005.)

- The modem adapter functions normally.
- End.

005 -

- Make sure that Windows 98 is properly installed, and then power off the system unit.
- Plug the modem adapter card into a different PCI slot.
- Go to step 002.
- If the error symptom still remains, replace the modem adapter card.
- End.

Audio (Not Supported by Diagnostics Program)

NOTE: Audio tests for the sound card cannot be carried out in the PC Doctor DOS diagnostics program. It is, however; possible to carry out a dial tone test for the modem.

While performing this check, you may need to enter and exit Microsoft Windows 98 several times. When instructed to select an icon or button, double-click on the item with the mouse.

For more information about using Microsoft Windows 98, see the user's guide that came with the computer.

If an operating system other than Microsoft Windows 98 is installed, the program screens and icons may differ from these instructions.

001 - START

- Power off the system unit.
- Remove all adapter cards.
- Connect a hard disk drive with pre-loaded Windows 98.
- Power on the system unit.
- Load default settings in setup (audio may be disabled).

002 - DO ANY POST MESSAGES, ERROR CODES, BEEPS, OR SYMPTOMS APPEAR? (YES, READ AHEAD. NO, GO TO STEP 003)

- Go to "Index of Symptoms, Messages, Error Codes, or Beeps" on page 50.
- End.

003 - DO ANY MESSAGES OR ERROR CODES DISPLAY AFTER POST COMPLETES BUT BEFORE MICROSOFT WINDOWS 98 STARTS? (YES, READ AHEAD. NO, GO TO STEP 004)

NOTE: If POST does not complete, answer this question "No".

- Make sure that Windows 98 is properly installed.
- End.

004 -

- Perform the following under Windows 98.

NOTE: If an operating system other than Microsoft Windows 98 is installed, the program screens and icons may differ from these instructions.

1. Start Microsoft Windows 98.
2. Select the **Start** icon.
3. Select **Settings**, then select **Control Panel**.
4. Select the **Sound** icon.
5. In the Sound window, select **chimes** from the **Names** field. (To test other adapter card software, select an action from a menu in that software.)

005 - IS THE PREVIEW BUTTON, OR ACTION IN OTHER SOFTWARE, SELECTABLE ON THE SCREEN (SHOWN IN BLACK AND NOT GRAY)? (YES, GO TO STEP 006. NO, READ AHEAD.)

- Make sure that Windows 98 is properly installed.
- Go to step 001.

006 -

- Select the **Preview** button from the Sound window.

007 - DO YOU HEAR ANY SOUND FROM THE SPEAKER? (YES, READ AHEAD. NO, GO TO STEP 008.)

- The audio feature is functioning normally. Click **Cancel** to close the dialog box. Exit Microsoft Windows 98.
- If the symptom remains or has changed, go to "Index of Symptoms, Messages, Error Codes, or Beeps" on page 50.
- End.

008 -

- Make sure that the volume control is not turned low.
- Make sure that the speaker and its adapter are not damaged.
- Make sure that the speaker is plugged into the speak-out jack. Refer to "Connectors and Functions of System Board of Machine Types 6266, 6270, 6276, 6279, 6280 and 6286" on page 102. If the error cannot be resolved, replace the system board.
- End.

CD-ROM Drive

001 - START

- Insert the diagnostics diskette into the diskette drive and make sure that there is no CD in the CD-ROM drive.
- Select **Interactive Tests** menu, then select and execute **CD-ROM Test**.

002 - DO YOU SEE A MESSAGE "NO CD-ROM DRIVE OR MSCDEX DEVICE DRIVER INSTALLED." ? (YES, READ AHEAD. NO, GO TO 003.)

- Exit the diagnostics program and power off the system.
- Check and make sure that the CD-ROM drive power cable and audio and data cables are not damaged and are connected properly.
- Check and make sure that the CD-ROM drive driver is loaded correctly.
- Load default settings.

003 - DO THE TESTS OF OPEN/CLOSE TRAY BY DIAGNOSTICS PROGRAM AND BY DEPRESSING CD-ROM DRIVE BUTTON WORK? (YES, READ AHEAD. NO, GO TO STEP 006.)

- Load a known good data CD into the CD-ROM drive and try to read its content by typing DIR at DOS prompt.

004 - CAN A CD BE READ FROM THE CD-ROM DRIVE? (YES, THEN THE CD-ROM DRIVE FUNCTIONS NORMALLY. NO, READ AHEAD.)

- Try reading the CD with a known good CD-ROM drive.

005 - IS THE CD STILL NOT READABLE? (YES, READ AHEAD. NO, GO TO STEP 006.)

- Replace system board.
- End.

006 -

- Replace CD-ROM drive.
- End.

Memory

001 - START

- Power off the system unit.
- Insert the diagnostics diskette into the diskette drive.
- Make sure that all DIMMs are installed correctly.
- Power on the system unit.
- Take note of any messages, error codes, or symptoms.

002 - DO YOU RECEIVE POST MEMORY ERROR MESSAGE? (YES, READ AHEAD. NO, GO TO STEP 003)

- Enter **BIOS Setup Utility** then reboot the system. Take note of any messages, error codes, or symptoms. If the error message remains, go to step 005.

003 -

- Follow the screen instructions to run the **Memory test**.

004 - DOES THE MEMORY TEST COMPLETE WITHOUT AN ERROR? (YES, READ AHEAD. NO, GO TO STEP 005.)

- The system memory is now functioning correctly. If you suspect an intermittent problem, run the **Memory test** again.
- End.

005 -

- Replace each DIMM, one at a time, with a known working DIMM of the same size and type.
- If the problem does not appear, it means that the last DIMM replaced is defective. If all DIMMs on the system board have been replaced and the problem remains, replace system board.
- Go to step 001.

NOTE: If on startup, there is no memory inserted on system board, you will hear 2 long beeps.

Keyboard

001 - START

- Power off the system unit and make sure that the keyboard plug is connected properly.

002 -

- Insert the diagnostics diskette into the diskette drive and power on the system unit.
- Select **Interactive Tests** menu, then execute **Keyboard** test.

003 - DOES THE KEYBOARD FUNCTION CORRECTLY? (YES, READ AHEAD. NO, GO TO STEP 004.)

- Keyboard is functioning normally.
- End.

004 - ARE THERE ANY STUCK KEYS OR ANY GRIME IN THE GAP OF KEYCAPS? (YES, READ AHEAD. NO, GO TO STEP 005.)

- Power off the system unit. Carefully remove the grime and solve the stuck keys problem.
- Go to step 001.

005 - ARE THERE ANY BROKEN PINS IN THE KEYBOARD PLUG? (YES, GO TO STEP 007. NO, READ AHEAD.)

- Try with a known good keyboard.

006 - DOES THE ERROR SYMPTOM STILL REMAIN? (YES, READ AHEAD. NO, GO TO STEP 007.)

- Replace the system board.
- End.

007 -

- Replace the keyboard.
- End.

Mouse

NOTE: A sticking key button can cause the mouse to operate incorrectly. If you suspect this, go to "Keyboard" on page 64.

001 - START

- Make sure that the mouse ball turns freely.
- Make sure that the mouse plug connects properly.

002 -

- Power off the system unit.
- Insert the diagnostics diskette into the diskette drive.
- Power on the system unit.
- Select **Interactive Tests** menu, then execute **Mouse** test.

003 - DO YOU SEE THE MOUSE CURSOR IN THE DIAGNOSTICS PROGRAM? (YES, READ AHEAD. NO, GO TO STEP 011)

- Test right (left) button and check if right (left) button works.

004 - DOES THE MOUSE BUTTON WORK? (YES, READ AHEAD. NO, GO TO STEP 007)

- Test mouse cursor movement.

005 - DOES THE MOUSE MOVE SMOOTHLY AND KEEP X AND Y COORDINATES CHANGED? (YES, READ AHEAD. NO, GO TO STEP 006)

- Mouse is functioning normally.
- End.

006 -

- Power off the system unit.
- Open mouse bottom cover and clean track ball.
- Go to step 002.

007

- Power off the system unit.
- Check the mouse plug.

008 - ARE THERE ANY BROKEN PINS IN THE MOUSE PLUG? (YES, GO TO STEP 010. NO, READ AHEAD.)

- Try with a known good mouse.

009 - DO THE ERROR SYMPTOMS STILL REMAIN? (YES, READ AHEAD. NO, GO TO STEP 010.)

- Replace the system board.
- End

010 -

- Replace the mouse.
- End.

011 -

- Exit diagnostics program.
- Make sure that the mouse driver is properly installed.
- Go to step 002.

Power Supply

001 - START

- Power off the system unit.
- Check the power cord for continuity. Replace if necessary.
- Check for the correct line voltage from the power outlet, and verify that the voltage selector switch is set to the correct voltage.
- Power on the system unit.

002 - DOES THE POWER SUPPLY FAN RUN? (YES, GO TO STEP 003. NO, GO TO STEP 004)

003 - DOES THE SYSTEM FAIL TO SHUT OFF WHEN THE ON/OFF SWITCH IS PRESSED? (YES, READ AHEAD. NO, GO TO STEP 005)

- You might have a damaged on/off switch cable assembly.
- Disconnect the on/off switch cable assembly connector from the power supply connector and take an ohm reading.
- Go to step 007.

004 -

- Disconnect the power cord from the back of the system unit.
- Disconnect all power and switch cable connectors from the system board and the power supply.
- Disconnect the power connectors to all drives.
- Connect the power connector to system board as a power load for driving up power supply.
- Reconnect the power cord.

005 - DOES THE POWER SUPPLY FAN RUN? (YES, READ AHEAD. NO, GO TO STEP 009)

- With the system powered on and the power supply fan running, check the voltages of the power supply connectors for the system board and all drive connectors, as shown in the following figures.

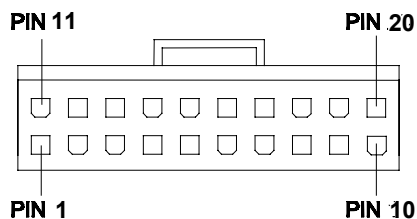

Power Supply Connectors (Bottom View)

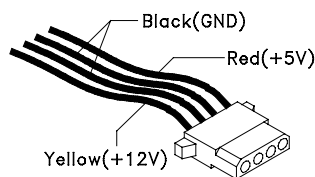

Hard Drive or CD-ROM End of Power Cable

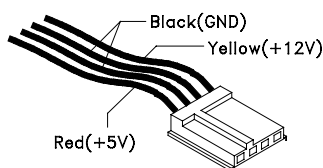

3.5-In. Diskette Drive End of Power Cable

006 - ARE THE VOLTAGES CORRECT AND DOES THE FAN RUN? (YES, READ AHEAD. NO, GO TO STEP 009)

- The power supply is working normally.
- If you suspect the on/off switch cable assembly, see Step 003.
- If the fan continues to run when all connectors are plugged back in, go to "Undetermined Problems" on page 69. If the fan stops running when a drive connector is plugged back in, go to "Start" on page 47.

007 - DO YOU HAVE AN OHM READING WHEN THE SWITCH IS PRESSED AND AN OPEN READING WHEN THE SWITCH IS RELEASED? (YES, READ AHEAD. NO, GO TO STEP 008)

- Replace the on/off switch cable assembly.

008 -

- Replace the system board.
- End.

009 -

- Replace the power supply.
- End.

Monitor

First, set the system to VGA mode. To do this in Windows 98, press the **F8** function key during startup. Safe mode (VGA) will be set for Windows 98. Use the operating system's video setup to change the monitor resolution.

If the monitor type is set to the power saving mode, the screen remains black and the LED lights or flashes in amber color. When the monitor is turned on alone, or is turned on and connected to a powered-off system unit, the monitor LED blinks in amber color. Under the normal operating conditions, the LED lights in green color.

NOTE: Some monitors have a detachable system I/O signal cable between the monitor and the system unit. Check the line voltage, power cord, and continuity for the system I/O signal cable before replacing the monitor. See "Monitor Port Signals" on page 111 for pin identification.

001 - START

- Power off the system unit and monitor.
- Remove all adapter cards.
- Make sure that the monitor I/O signal cable is properly connected to the system unit and monitor.
- Make sure that the power cords are properly connected to the system unit and monitor, and that the line voltage is correct.
- Make sure that the monitor contrast and brightness controls are not turned too low.
- Make sure that the diagnostics diskette is in the diskette drive.
- Power on the monitor, and wait 20 seconds.
- Power on the system unit.

NOTE: If the monitor was not sold together with the system unit, you may need to refer to the service information provided with the monitor.

002 - IS THE SCREEN READABLE? (YES, READ AHEAD. NO, GO TO STEP 004)

NOTE: If the screen shows a blinking cursor with no memory count running, answer this question "No".

- Select **Interactive Tests** from the Main Menu.
- Select and execute **Video** test from the menu.
- Follow the prompts and perform the video test.
- Go to "Index of Symptoms, Messages, Error Codes, or Beeps" on page 50.

NOTE: You might have to adjust the monitor controls to obtain the best image.

003 - DOES THE MONITOR SUCCESSFULLY PASS ALL TESTS? (YES, READ AHEAD. NO, GO TO STEP 004)

- You have successfully completed the video diagnostics tests. If the problem remains, go to "Index of Symptoms, Messages, Error Codes, or Beeps" on page 50.
- End.

004 -

- Power off the system unit.
- Remove the hard disk drive system cable.
- Power on the system unit.

005 - IS THE SCREEN READABLE?

- Replace the monitor. If the symptom remains, replace the system board.
- End.

Undetermined Problems

If an error code is present, go to "Index of Symptoms, Messages, Error Codes, or Beeps" on page 50. If no error code is present, continue with this check. Check the power supply voltages (see "Power Supply Cable Connector Specifications" on page 103). If the voltages are correct, return here and continue with the following steps:

1. Power off the system unit.

2. Perform the following checks, one by one, until you have isolated the problem FRU (refer to "Parts/Test Point Locations" on page 99 for locations):

- Load default settings in setup.
- Check all system board jumper positions and switch settings.
- Check all adapter card jumper positions.
- Check all device jumper positions.
- Check all cables and connectors for proper installation.

If the jumpers, switch, and voltage settings are correct, return here and continue:

3. Remove or disconnect the following, one at a time:

- Non-IBM devices
- External devices
- Any adapters
- Modem card, if installed
- CD-ROM drive
- Diskette drive
- Hard disk drive
- DIMM
- Processor
- System board

4. Power on the system unit.

5. Repeat steps 1 through 4 until you find the failed device or adapter.

6. If software related, reload software from Recovery CD.

If the symptom changes, go to "Index of Symptoms, Messages, Error Codes, or Beeps" on page 50 or to the check procedure for the last item tested.

Replace the last item tested if the system operates normally after removing the last item.

Diagnostic Aids

Diagnostic Aids	71
Introduction	72
Power-On Self Test	73
Diagnostics Tools	74
Using Diagnostics Program from Recovery CD	74
Diagnostics Program Features	75

Introduction

This section explains the diagnostic aids, power-on self test (POST) and diagnostics program (PC-Doctor), that are available for troubleshooting problems on the system.

Power-On Self Test

Each time you power-on the system, the power-on self test (POST) is initiated. Several items are tested during POST, but is for the most part transparent to the user.

POST checks the following:

- System Board
- Memory
- SVGA Controller
- Hard Disk Drive(s)
- Floppy Diskette Drive(s)
- Keyboard
- Mouse
- Parallel Port(s)
- Serial Port(s)
- CD-ROM Drive(s)
- Sound Controller

To start POST, turn on the monitor and then the system unit. The following will happen:

1. The IBM logo will appear on center of the screen.
2. At this time one of two hot-keys may be used. The F1 key, as described on screen, will cause the system Setup Utility menu to appear. The F9 key will switch the graphical IBM logo screen to the traditional text-based system startup screen, which displays BIOS version and system memory tested.
3. If an error is detected during POST, the IBM logo screen will automatically switch to the text-based screen and display the error message or code with a beep. Depending on the criticality of the POST error, the system may halt and/or display the message "Press F1 to go to the Setup or Enter to continue".

If this message appears, pressing the Enter key will allow the system to attempt to proceed despite the reported error; pressing F1 will cause the system Setup Utility menu to appear.

4. If no keyboard keys are pressed, and if POST is completed without errors, the system will then proceed with the loading of DOS or other operating system from diskette drive A or a hard disk drive or CD-ROM drive, depending on the options selected in the Setup Utility.

If any errors are detected by POST, there will be an error message accompanied with an error code shown on display screen and a beep. See "Index of Symptoms, Messages, Error Codes, or Beeps" on page 50 to find the most likely cause and countermeasure.

Diagnostics Tools

IMPORTANT: This manual is intended to test the IBM Machine Types 6266, 6270, 6276, 6279, 6280 and 6286. Testing devices which are not included with the original product package, including other IBM products, prototype cards, or modifying hardware settings may give false errors and invalid system responses. The diagnostics not specifically made for this model may also report incorrect errors and information.

The diagnostics program comes on a CD (compact disk) along with this book. This version of PC-Doctor diagnostics program, developed by Watergate for IBM, is the primary method of testing the computer. You can use it to test the IBM components of the system and some external devices. The amount of time required to test components depends on the number of components installed and selected. The more devices you have attached to your system and selected in PC-Doctor, the longer the testing will take.

Using Diagnostics Program from Recovery CD

1. Insert the recovery CD into the CD-ROM drive then restart computer.
2. Press F1 during POST to enter BIOS Setup menu. Select and enter "**BIOS Features Setup**", set "**Boot Sequence to CD-ROM, A, C**". Save and exit from BIOS Setup.
3. When screen prompts to install original software, type **N** to exit the installation program. Then type **PCDR** and press **Enter** to start the diagnostics program. Follow the instructions on the screen to operate the diagnostics program.

Diagnostics Program Features

Diagnostics program (PC-Doctor for DOS) includes the following features:

Table 3-1. Diagnostics Program Features	
Main Menu Selections	Submenu Selections
Diagnostics	<ul style="list-style-type: none"> • System Test • Memory Test • Hard Disk Test • Floppy Disk Test • All Tests
Interactive Tests	<ul style="list-style-type: none"> • Keyboard • Video • Internal Buzzer • Mouse • Joystick Test • Diskette • Printer Test • SCSI Test • CD-ROM/DVD Test • Stereo Speaker
Hardware Info	<ul style="list-style-type: none"> • Onboard Ethernet • USB Port • System Configuration • Memory Contents • IRQ and DMA Use • Device Drivers • COM and LPT Ports • Physical Disk Drives • Logical Disk Drives • VGA Information • Software Interrupts • SCSI Devices • I/O Use • IDE Drive Info • Network Information • PCMCIA Information • PCI Information • SMP Information • PNPISA Info • DMIBIOS Info
Utility	<ul style="list-style-type: none"> • File Editor • Surface Scan Hard Disk • Terminal • Tech Support Form • Battery Rundown • Select Language
Quit	<ul style="list-style-type: none"> • Exit Diags • Park HD • Reboot • Upgrade Now

Repair Information

Repairing Information	77
Removals and Replacements of Machine Types 6270, 6276, 6279 and 6280	78
Identifying the Parts of the System Unit	79
Top Cover	81
Adapter Cards	82
Diskette Drive	83
CD-ROM Drive	84
Hard Disk Drive	85
System Board	86
Power Supply	87
Memory (DIMM)	88
Removals and Replacements of Machine Types 6266 and 6286	89
Identifying the Parts of the System Unit	90
Top Cover	91
Adapter Cards	92
Diskette Drive	93
CD-ROM Drive	94
Hard Disk Drive	95
System Board	96
Power Supply	97
Memory (DIMM)	98

Removals and Replacements of Machine Types 6270, 6276, 6279 and 6280

BEFORE REMOVING ANY FRU, POWER-OFF THE COMPUTER, UNPLUG ALL POWER CORDS FROM ELECTRICAL OUTLETS, THEN DISCONNECT ANY INTERCONNECTING CABLES.

ATTENTION: The System board, processors, adapter cards, DIMMs, and upgrade processors can be damaged by electrostatic discharge. Use an electrostatic discharge (ESD) strap to establish personal grounding. If you don't have an ESD strap, establish personal grounding by touching a ground point with one hand before touching the static-sensitive FRUs.

The Arrows in the removals and replacements procedures show the direction of movement to remove a field-replaceable unit (FRU), to turn a screw, or the direction to press a tab to release the FRU.

Begin all removals by removing the cover (and rear cover, if applicable). When other FRUs must be removed prior to removing the failing FRU, they are listed at the top of the page. Go to the removal procedure for each FRU listed. Remove the FRU, and then continue with the removal of failing FRU.

To replace a FRU, reverse the removal procedure and follow any notes that pertain to replacement.

Before disconnecting any cables, note their location and orientation. Reinstall any new FRUs with cabling in their original location.

Identifying the Parts of the System Unit

This computer system has 3 bays, each bay has a factory-installed drive in it. The devices are 3.5" Diskette, 48X CD-ROM drive and 10, 15 or 20 GB hard disk.

Diskette drives in this unit use the standard diskette advanced technology (AT) Interface. Hard disk and CD-ROM drives in this unit use an integrated drive Electronics (IDE) AT interface. This computer supports the American National Standard Institute (ANSI) standard for AT attachment disk drives and CD-ROMs.

This system has 3 interface cards slots for adapter card expansion. All of them are Peripheral Component Interconnect (PCI) interfaces.

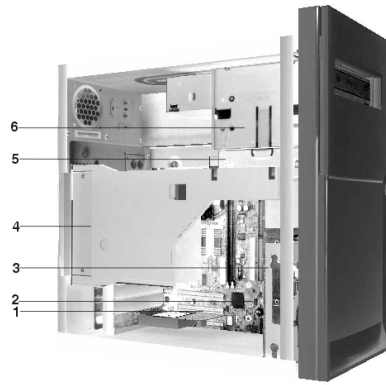

1. Expansion slots

On the rear panel of the system unit are 3 slot openings for installation of adapter card.

2. Hard Disk Drive

This machine has a factory-installed 3.5" (10 or 15) GB hard disk drive.

3. Power Supply

4. Bay 2

This drive can accommodate a 5.25-inch device.

5. Bay 1.

This drive bay can accommodate a 5.25-inch half-high drive such as a diskette, hard disk, tape, or CD-ROM. In many models, this bay holds a factory-installed CD-ROM drive.

Top Cover

To remove the top cover of this system unit:

- ❑ Remove the 3 screws that secure the top cover at the back of the system unit.
- ❑ Hold both sides of the system unit cover and push it backward about 25 inches.
- ❑ Lift the top cover up to remove it completely.
- ❑ Touch the bare metal frame of your system unit to dissipate the static electricity from your body. Do not touch any of the components inside the frame before you touch the frame. Do not touch any of the components that have a voltage-warning label.

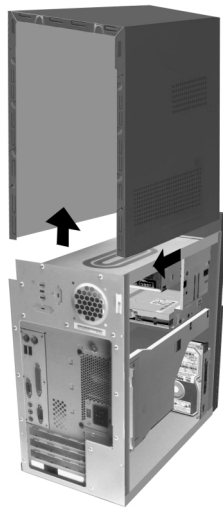

Adapter Cards

Installing Adapter Cards

- Align and insert the adapter card into the adapter card connector.
- Secure the card with the screw to the system chassis.
- Reinstall all hardware and screws that you removed prior to the installation of the adapter card.



Removing Adapter Cards

Follow these steps to remove an adapter card:

- Position the system unit so that the card is accessible to you.
- If the adapter card has cables, disconnect them. Be sure to take note of where the cable is connected. You will have to reconnect these cables when you reinstall the card.
- Firmly hold the adapter card and carefully pull it from the card connector.
- If you are not reinstalling the card, reinstall all other hardware and screws that were removed prior to the removal of the adapter card.

Diskette Drive

To remove the diskette drive:

- Remove the screw that secures the power at the back of the system unit.
- Pull the latch on the drive mounting tray and the power upward to remove it completely.
- Disconnect the power and signal cables from the back of the diskette drive.
- Remove the two screws that hold the diskette drive to the mounting tray.
- Open the door on the front of the computer.
- Pull the diskette drive toward the front of the computer to remove it.
- Reverse the procedure to install a new drive.

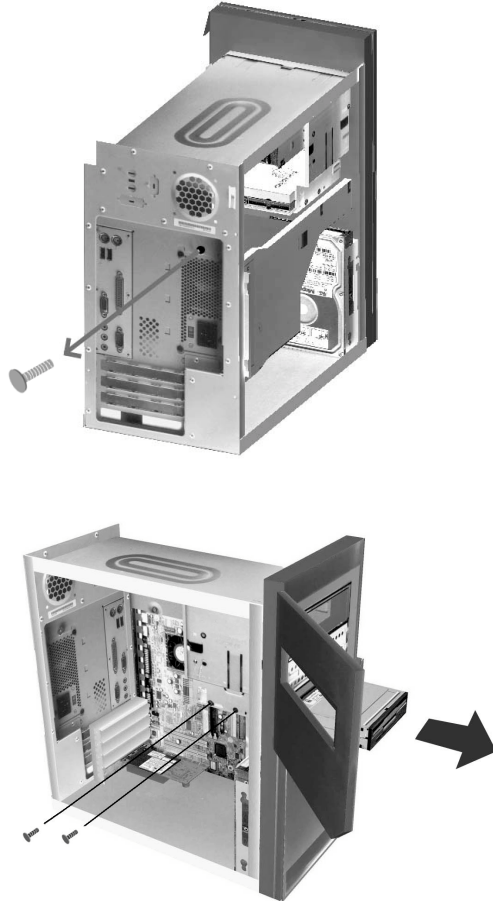

CD-ROM Drive

To remove CD-ROM Drive:

- Disconnect the power, sound and signal cables from the CD-ROM.
- Remove the two screws that secure the CD-ROM drive

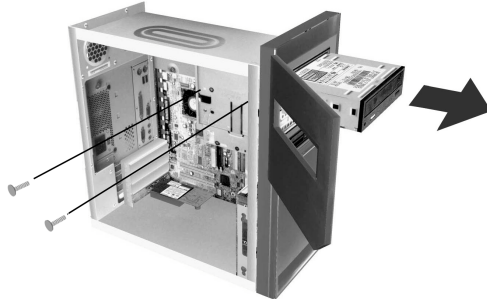

- Open the door on the front of the computer.
- Slide the CD-ROM drive forward through the front opening and remove it.
- Reverse the procedure to install a new drive.

Hard Disk Drive

To remove or replace the hard disk drive:

- Disconnect the power and signal cables from the diskette drive.
- Remove the two screws that secure the mounting tray at the bottom of the system unit.
- Pull the drive mounting tray upward and remove it.



- Remove the four screws (two on each side) that secure the hard diskette drive to the mounting tray.
- Pull the hard disk drive from the mounting tray to remove.
- Reverse the procedure to install a drive.

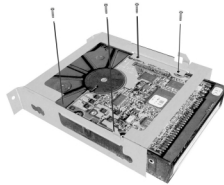

System Board

To remove the system board from the system:

- To remove the system board, you must remove the adapter cards first.
- Disconnect the power cable, CD-ROM cable, Diskette Drive cable, Hard Disk Drive cable, audio cable, power switch cable, speaker cable and LED cable from system board.
- Remove the six screws on system board.

Note: Be sure to stay the I/O Port Bracket on chassis when replacing the system board.

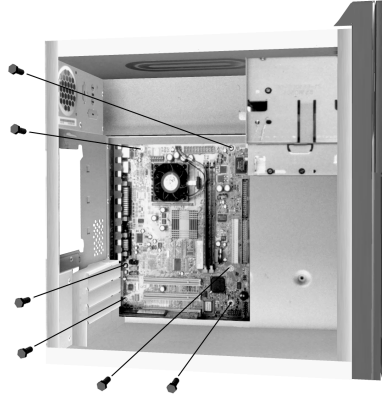

Power Supply

This system has a 155-watt switching power supply.

1. To remove the power supply. You must remove the top cover first.
2. Disconnect the power cable from the riser board and all drives.
3. Remove the screw in the machine rear that secures the power supply.

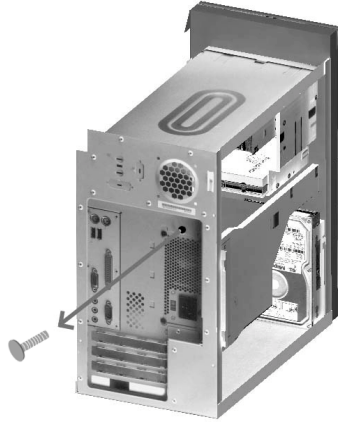

Memory (DIMM)

This system has 2 system memory module sockets, DIMM 0 and DIMM 1. These sockets hold dual in line memory modules (DIMM) that contains 3.3V signal or double-sided synchronous DRAM (SDRAM).

You can install 32MB, 64MB, 128MB or 256MB DIMM in any sockets and with any combinations.

The maximum memory size is 512 MB total.

Removals and Replacements of Machine Types 6266 and 6286

BEFORE REMOVING ANY FRU, POWER-OFF THE COMPUTER UNPLUG, ALL POWER CORDS FROM ELECTRICAL OUTLETS, THEN DISCONNECT ANY INTERCONNECTING CABLES.

ATTENTION: The System board, processors, adapter cards, DIMMs, and upgrade processors can be damaged by electrostatic discharge. Use an electrostatic discharge (ESD) strap to establish personal grounding. If you don't have an ESD strap, establish personal grounding by touching a ground point with one hand before touching the static-sensitive FRUs.

The Arrows in the removals and replacements procedures show the direction of movement to remove a field-replaceable unit (FRU), to turn a screw, or the direction to press a tab to release the FRU.

Begin all removals by removing the cover (and rear cover, if applicable). When other FRUs must be removed prior to removing the failing FRU, they are listed at the top of the page. Go to the removal procedure for each FRU listed. Remove the FRU, and then continue with the removal of failing FRU.

To replace a FRU, reverse the removal procedure and follow any notes that pertain to replacement.

Before disconnecting any cables, note their location and orientation. Reinstall any new FRUs with cabling in their original location.

Identifying the Parts of the System Unit

This computer system has 3 bays, each bay has a factory-installed drive in it. The devices are 3.5" Diskette, 40X CD-ROM drive and 10, 15 or 20 GB hard disk.

Diskette drives in this unit use the standard diskette advanced technology (AT) Interface. Hard disk and CD-ROM drives in this unit use an integrated drive Electronics (IDE) AT interface. This computer supports the American National Standard Institute (ANSI) standard for AT attachment disk drives and CD-ROMs.

This system has 3 interface cards slots for adapter card expansion. All of them are Peripheral Component Interconnect (PCI) interfaces.

This system has 1 video bridge expansion slot adjacent to the PCI slots. All models of this system will use a Lake Clark 2.4 card or Ethernet card.

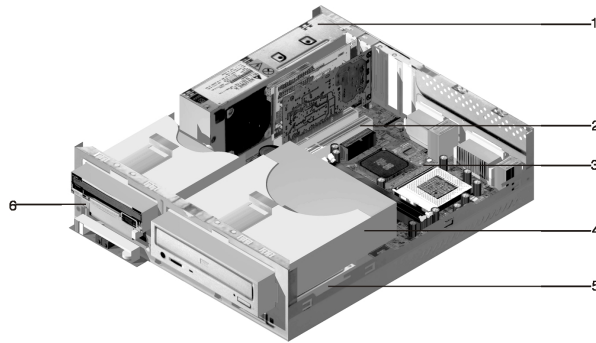

1. Power Supply

This is a 95-watt switching power supply.

2. Expansion slots

On the rear panel of the system unit are 3 slot openings for installation of adapter card.

3. System board

4. CD-ROM Drive

This machine has a factory-installed 40 X CD-ROM drive 5. Hard Disk Drive

5. This machine has a factory-installed 10, 15 or 20 GB hard disk drive.

6. Diskette Drive

This machine has a factory-installed 3.5" 1.44MB floppy drive.

Top Cover

To remove the top cover of this system unit:

- Remove the screws that secure the top cover at the back of the system unit.
- Hold both sides of the system unit top cover and push it forward about 25 inches.
- Lift the top cover up to remove it completely.
- Touch the bare metal frame of your system unit to dissipate the static electricity from your body. Do not touch any of the components inside the frame before you touch the frame. Do not touch any of the components that have a voltage-warning label.

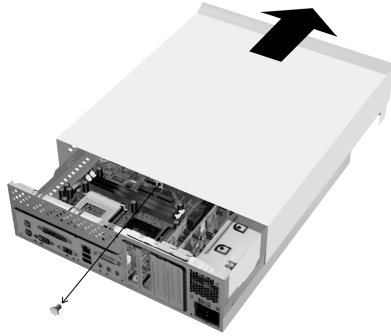

- Disconnect the system unit power cord.

Adapter Cards

Installing Adapter Cards

- Remove the screw that secures the adapter card retainer and slot cover. Then remove the card retainer and slot cover.
- Align and insert the adapter card into the adapter card connector.
- Secure the card with the screw that you removed in the first step.
- Reinstall all hardware (except for the slot cover, which cannot be reinstalled) and screws that you removed prior to the installation of the adapter card.

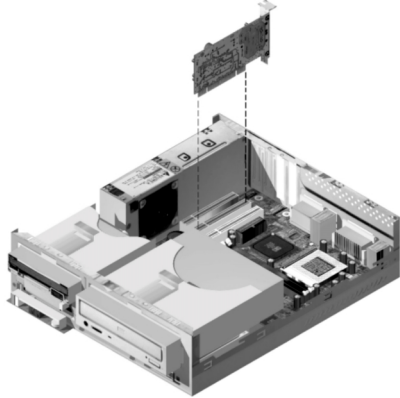

Removing Adapter Cards

Follow these steps to remove an adapter card:

- Position the system unit so that the card is accessible to you.
- If the adapter card has cables, disconnect them. Be sure to take note of where the cable is connected. You will have to reconnect these cables when you reinstall the card.
- Remove the adapter card screw
- Firmly hold the adapter card and carefully pull it from the card connector.
- If you are not reinstalling the card, reinstall all other hardware and screws that were removed prior to the removal of the adapter card.

Diskette Drive

To remove the diskette drive:

- Disconnect the power and signal cables from the back of the diskette drive.
- Pull up the latch that secures the drive-mounting tray.

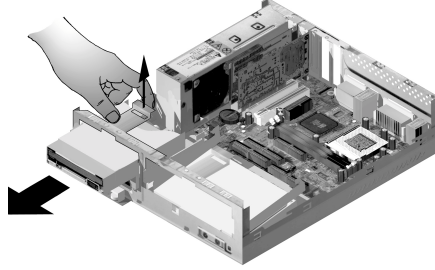

- Slide the drive-mounting tray toward the front of the computer and remove it.
- Remove the four screws (two on each side) that secure the bay holder.
- Pull the diskette drive from the mounting tray to remove it.
- Reverse the procedure to install a new drive.

CD-ROM Drive

To remove CD-ROM Drive:

- Disconnect the power, sound and signal cables from the CD-ROM.
- Pull up the latch that secures the CD-ROM drive mounting tray.

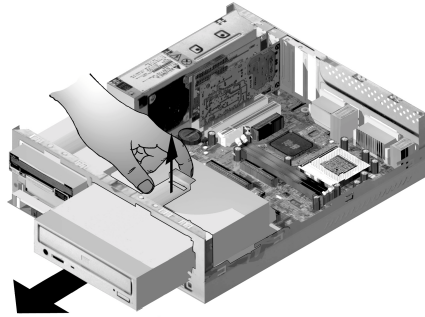

- Slide the drive-mounting tray toward the back of the computer and remove it.
- Remove four screws (two on each side) that secure the bay holder.
- Pull the bay holder backward and lift it up to remove it completely.
- Reverse the procedure to install a new drive.

Hard Disk Drive

To remove or replace the hard disk drive:

- Follow the above steps to remove the CD-ROM.
- Make sure to disconnect the power cord and signal cables from the hard disk drive and the diskette device.
- Remove the screws that secure the bay holder that holds the hard diskette drive.

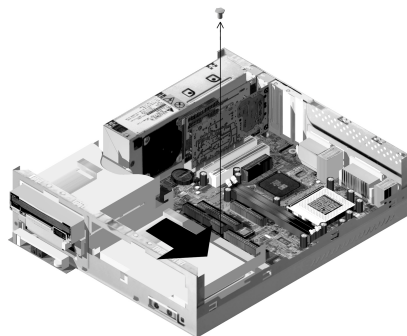

- Pull the bay holder right to uncouple it from the chassis completely and lift it up.

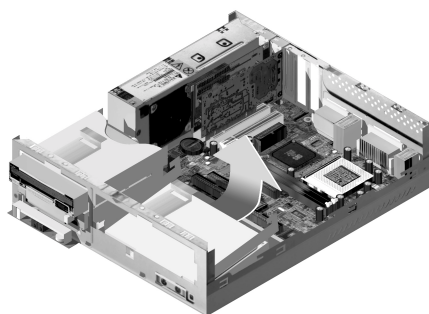

System Board

To remove the system board from the system:

- To remove the system board, you must remove the adapter cards first.
- Disconnect the power cable, CD-ROM cable, Diskette Drive cable, Hard Disk Drive cable, audio cable, power switch cable, speaker cable and LED cable from system board.
- Remove the eight screws on system board.

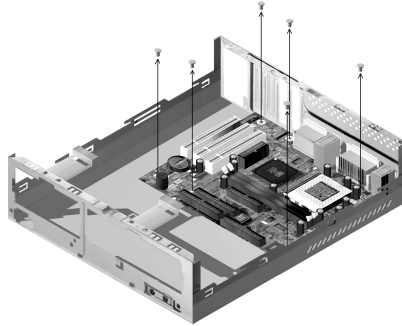

Power Supply

This system has a 95-watt switching power supply.

1. To remove the power supply. You must remove the top cover first.
2. Disconnect the power cable from the riser board and all drives.
3. Remove the screws in the machine rear that secure the power supply.

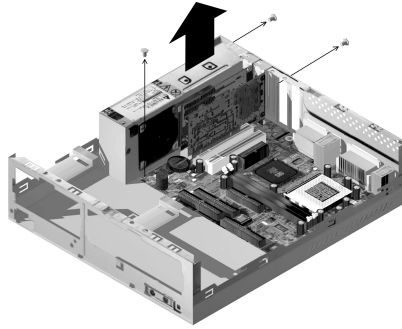

Memory (DIMM)

This system has 2 system memory module sockets, DIMM 0 and DIMM 1. These sockets hold dual in line memory modules (DIMM) that contains 3.3V signal or double-sided synchronous DRAM (SDRAM).

The maximum memory size is 512 MB total.

Parts/Test Point Locations

Parts/Test Point Locations	99
Introduction	100
Layout of System Board of Machine Types 6266, 6270, 6276, 6279	101
Connectors and Functions of System Board of Machine Types 6266, 6270, 6276, 6279	102
Power Supply Cable Connector Specifications	103
Main Output Pin Assignment	104
Factory-Installed Modem Card Layout	106
Factory-Installed Modem Card Connector Functions	106
3.5-In. Hard Disk Drive Jumper Locations & Settings	107
CD-ROM Drive	108
CD-ROM Drive Rear Panel Connectors and Features	108
CD-ROM Drive Jumper Settings	109
DIMM Configurations	110
System Board Connector Pin Signals	111
Monitor Port Signals	111
Serial Port Signals	111
Parallel Port Signals	111
Mouse Port Signals	111
Keyboard Port Signals	112
Diskette Drive Cable Connector Signals	113
IDE Cable Connector Signals	114

Introduction

This chapter contains system board layout and jumper settings. It is useful when you are asked to measure voltages. Use this information to help you locate parts such as electronic boards, connectors, pin numbers, and test points. This chapter also contains jumper settings for the hard disk drive, CD-ROM (compact disc-read-only memory) drive, and the connector information for modem adapter card.

Layout of System Board of Machine Types 6266, 6270, 6276, 6279, 6280 and 6286

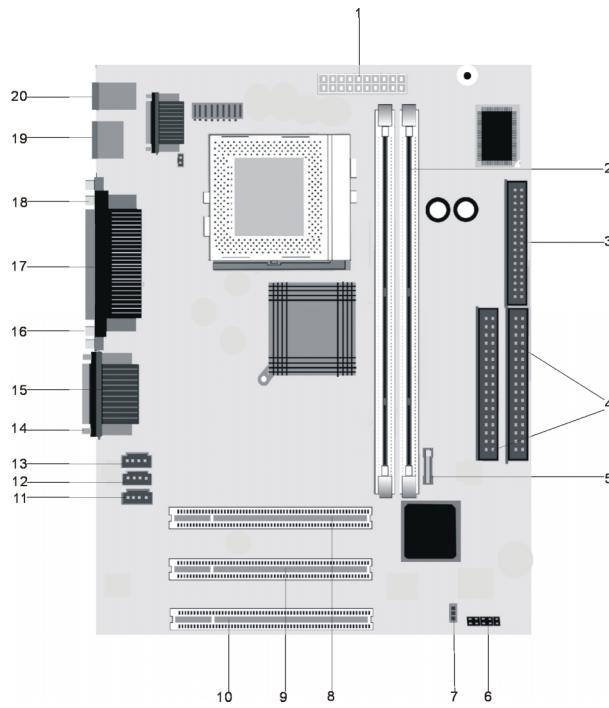

**Jumpers and Connectors Locations of System Board of Machine Types
6266, 6270, 6276, 6279, 6280 and 6286**

- | | |
|--------------------------------------|---|
| 1. Power connector (JWR1) | 11. Modem In connector (J7) |
| 2. DIMM | 12. Aux Line In connector (J6) |
| 3. Floppy Disk connector (FDD1) | 13. CD In connector (J5) |
| 4. Hard Disk Connector (IDE1 & IDE2) | 14. Audio Port connector |
| 5. Battery | 15. Serial Port connector 1 (COM A) |
| 6. Case connector (JFP2) | 16. VGA Port connector |
| 7. Clear CMOS jumper (JBAT) | 17. Parallel Port connector (LPT1) |
| 8. PCI SLOT 1 | 18. Serial Port connector 2 (COM B) |
| 9. PCI SLOT 2 | 19. USB |
| 10. PCI SLOT 3 | 20. Mouse and Keyboard connector (JKBMS1) |

Connectors and Functions of System Board of Machine Types 6266, 6270, 6276, 6279, 6280 and 6286

Table 5-1. Connectors and Functions of System Board of Machine Types 6266, 6270, 6276, 6279, 6280 and 6286	
Connector	Function
BATT	Battery socket
FDD 1	Floppy connector
PCI Slot 1	PCI Slot 1
PCI Slot 2	PCI Slot 2
PCI Slot 3	PCI Slot 3
JBAT	Clear CMOS jumper
JFP1	HDD LED, Power LED, Speaker, Power Switch and Reset Switch
IDE 1	Primary IDE
IDE 2	Secondary IDE
JWR1	ATX Power Connector
COMA	Serial Port Connector 1
COMB	Serial Port Connector 2
LPT1	Parallel Port Connector
VGA	VGA Connector
JKBMS 1	Keyboard / Mouse connector
J5	CD-In Connector
J6	Aux Line In Connector
J7	Modem In Connector
USB	Universal Serial Bus Connector

Power Supply Cable Connector Specifications

Refer to the following figures when checking for voltages on power supply cable connectors.

When checking voltages, the power supply fan must be running. To power on the power supply without using the on/off switch, use a screwdriver or other tools to short the power supply connector (with the switch cable disconnected from the connector on the system board) or use a connection (jumper) to short the black and green wires of the 20-pin connector on power supply.

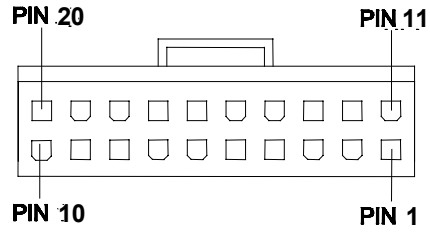

System Board Power Supply Connectors

Main Output Pin Assignment

Table 5-3. Main Output Pin Assignment		
Pin	Function	Color
1	+3.3 V	Orange
2	3.3 V	Orange
3	COMMON	BLACK
4	+5Vdc	RED
5	COMMON	BLACK
6	+5Vdc	RED
7	COMMON	BLACK
8	POWER GOOD	GRAY
9	+5Vs	PURPLE
10	+12Vdc	YELLOW
11	3.3V	Orange
12	-12Vdc	BLUE
13	COMMON	BLACK
14	P.S-on	GREEN
15	COMMON	BLACK
16	COMMON	BLACK
17	COMMON	BLACK
18	NC	NC
19	+5Vdc	RED
20	+5Vdc	RED

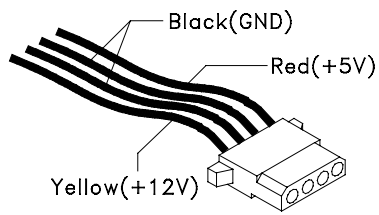

Hard Drive or CD-ROM Power Cable Connector

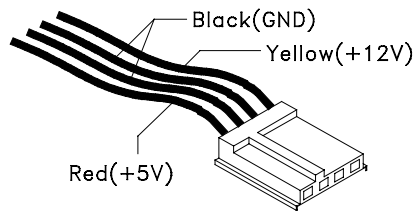

3.5-In. Diskette Drive Power Cable Connector

Factory-Installed Modem Card Layout

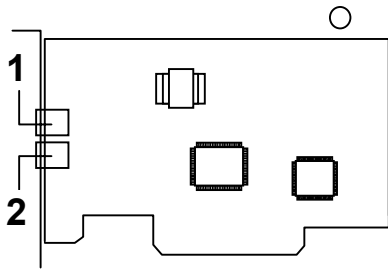

Factory-Installed Modem Card Layout

Factory-Installed Modem Card Connector Functions

Item	Function	Connect to
1	Telephone line-out Some modem adapters may come without this jack.	Telephone set
2	Telephone line-in	Telephone line

NOTE: Care should be taken while connecting the voice-in/speaker-out connector. The longer exposed end (approx. 15mm) of the cable should be connected to the modem card. The other end should be connected to the system board.

3.5-In. Hard Disk Drive Jumper Locations & Settings

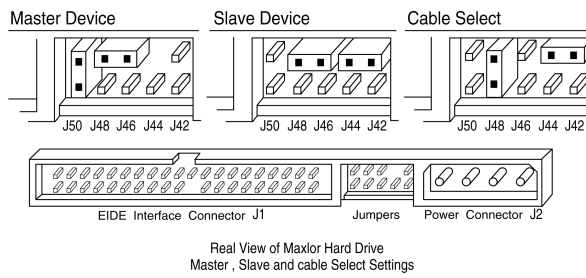

3.5-In. Hard Disk (Maxtor) Jumper Settings Locations

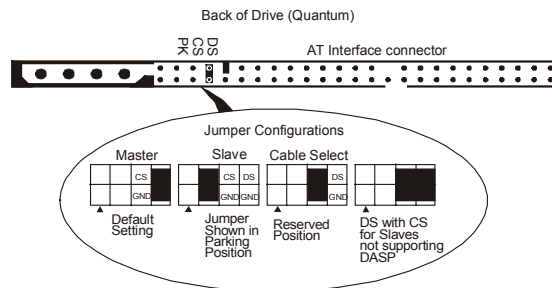

3.5-in Hard Disk (Quantum) Jumper Settings Locations

CD-ROM Drive

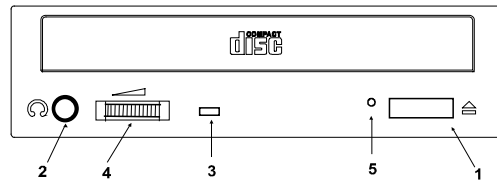

CD-ROM Front Panel

NOTE: Position of CD-ROM switches and LEDs may vary from illustration.

Item	Description
1	Load / eject button
2	Headphone jack
3	Power-on / busy indicator, lights up in green color while disc is set in ready state; lights up and flashes in amber color during data read or seek operation.
4	Headphone volume control
5	Emergency eject hole. See CD-ROM Emergency-exit below.

CD-ROM Emergency-exit

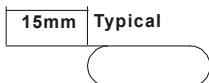

If for any reason the tray does not eject automatically, insert and press an eject-bar inside the emergency eject hole to manually eject the tray. A straightened paper clip with a diameter of 1.2 mm (typical) can be used as an eject-bar.

NOTE: Make sure to turn off the power before manual discs eject operation.

CD-ROM Drive Rear Panel Connectors and Features

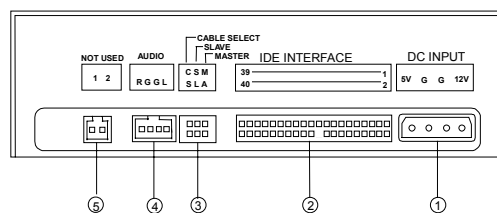

CD-ROM Rear Panel

Item	Function	Connect to...
1	Power supply connector	Power supply
2	Configuration jumper.	--
3	NOT USED	--

CD-ROM Drive Jumper Settings

CS	SL	MA	DESCRIPTION
--	--	On	Drive configured as a Master. (default)
--	On	--	Drive configured as a Slave.
On	--	--	Cable select

DIMM Configurations

The system board has two DIMM sockets. A maximum of 512KB memory may be installed.

You can install 32MB, 64MB, 128MB or 256MB DIMM in any sockets and with any combinations.

System Board Connector Pin Signals

Monitor Port Signals

Pin	Signal Name	I/O	Pin	Signal Name	I/O
1	Red Video	O	9	+5 V dc	N/A
2	Green Video	O	10	Synch Ground	N/A
3	Blue Video	O	11	No Connection	N/A
4	No Connection	N/A	12	Monitor ID Bit 1	I
5	Synch Ground	N/A	13	Horizontal Synch	O
6	Red Ground	N/A	14	Vertical Synch	O
7	Green Ground	N/A	15	Monitor ID Bit 3	I
8	Blue Ground	N/A			

Serial Port Signals

Pin	Signal Name	I/O	Pin	Signal Name	I/O
1	Data Carrier Detect	I	6	Data Set Ready	I
2	Receive Data	I	7	Request To Send	O
3	Transmit Data	O	8	Clear To Send	I
4	Data Terminal Ready	O	9	Ring Indicator	I
5	Signal Ground	N/A			

Parallel Port Signals

Pin	Signal Name	I/O	Pin	Signal Name	I/O
1	Strobe	O	14	Auto Feed	N/A
2	Data Bit 0	I/O	15	Error	I
3	Data Bit 1	I/O	16	Initialize	O
4	Data Bit 2	I/O	17	Select (In)	O
5	Data Bit 3	I/O	18	Ground	Power
6	Data Bit 4	I/O	19	Ground	Power
7	Data Bit 5	I/O	20	Ground	Power
8	Data Bit 6	I/O	21	Ground	Power
9	Data Bit 7	I/O	22	Ground	Power
10	Acknowledge	I	23	Ground	Power
11	Busy	I	24	Ground	Power
12	Paper Empty	I	25	Ground	Power
13	Select	O			

Mouse Port Signals

Pin	Signal Name	I/O	Pin	Signal Name	I/O
1	Mouse Data	I/O	4	+5 V dc	Power
2	No Connection	N/A	5	Mouse Clock	I/O
3	Ground	Power	6	No Connection	N/A

Keyboard Port Signals

Pin	Signal Name	I/O	Pin	Signal Name	I/O
1	Keyboard Data	I/O	4	+5 V dc	Power
2	Mouse Data	N/A	5	Keyboard Clock	I/O
3	Ground	Power	6	Mouse Clock	N/A

Diskette Drive Cable Connector Signals

Pin	Signal Name	I/O	Pin	Signal Name	I/O
1	No Connection	N/A	18	Direction SELECT	O
2	Density Select	O	19	Ground	N/A
3	No Connection	N/A	20	Step	O
4	High Density Out	I	21	Ground	N/A
5	Ground	N/A	22	Write Data	O
6	No Connection	N/A	23	Ground	N/A
7	Ground	N/A	24	Write GATE	O
8	Index	I	25	Ground	N/A
9	Ground	N/A	26	Track 0	I
10	No Connection	N/A	27	Ground	N/A
11	Ground	N/A	28	Write Protect	I
12	Drive Select 1	O	29	Ground	N/A
13	Ground	N/A	30	Read Data	I
14	No Connection	N/A	31	Ground	N/A
15	Ground	N/A	32	SIDE 1 SELECT	O
16	Motor On	O	33	Ground	N/A
17	Ground	N/A	34	Diskette Change	I

IDE Cable Connector Signals

Pin	Signal Name	I/O	Pin	Signal Name	I/O
1	Host Reset	O	21	DMA Request	I
2	Ground	N/A	22	Ground	Power
3	Host Data 7	I/O	23	Host IOW	O
4	Host Data 8	I/O	24	Ground	Power
5	Host Data 6	I/O	25	Host IOR	O
6	Host Data 9	I/O	26	Ground	Power
7	Host Data 5	I/O	27	I/O Channel Ready	I
8	Host Data 10	I/O	28	No Connection	N/A
9	Host Data 4	I/O	29	DMA Acknowledge	O
10	Host Data 11	I/O	30	Ground	Power
11	Host Data 3	I/O	31	Host IRQ	I
12	Host Data 12	I/O	32	No Connection	N/A
13	Host Data 2	I/O	33	Host A1	O
14	Host Data 13	I/O	34	No Connection	N/A
15	Host Data 1	I/O	35	Host A0	O
16	Host Data 14	I/O	36	Host A2	O
17	Host Data 0	I/O	37	Host CS0	O
18	Host Data 15	I/O	38	Host CS1	O
19	Ground	Power	39	ACTIVE bar	I
20	No Connection	N/A	40	Ground	Power

Safety Inspection Guide

General Guidelines..... 116

General Guidelines

The purpose of this Safety Inspection Guide is to help you identify possible unsafe conditions on machines that are being inspected for a Maintenance Agreement. Each machine has necessary functions items installed to provide the operators and service personnel with an acceptable level of safety. This guide lists only these items. Good judgment should be used to identify possible safety conditions not covered by this Safety Inspection Guide.

If any unsafe conditions are present, you must find out how serious the hazard is and if you can continue before you correct the hazard.

All current IBM service supplements outlining feature/model changes, along with the machine history, should be reviewed.

Check the following items:

- Damaged, missing, or changed parts, especially in the area of the On/Off switch and the power supply.
- Damaged, missing, or changed covers.
- Possible safety exposure from any non-IBM attachments.

Parts Catalog of Machine Type

Parts Catalog of Machine Types 6270, 6276, 6279 and 6280.....	118
Assembly 1: System Unit.....	118
Assembly 2: Diskette Drive, Hard Disk Drive	120
Assembly 3: CD-ROM, Modem Card.....	121
Assembly 4: Keyboard and Mouse	123
Parts Catalog of Machine Types 6266.....	126
Assembly 1: System Unit.....	126
Assembly 2: Diskette Drive, Hard Disk Drive	128
Assembly 3: CD-ROM, Modem Card.....	129
Assembly 4: Keyboard and Mouse	130

Parts Catalog of Machine Types 6270, 6276, 6279 and 6280

Assembly 1: System Unit

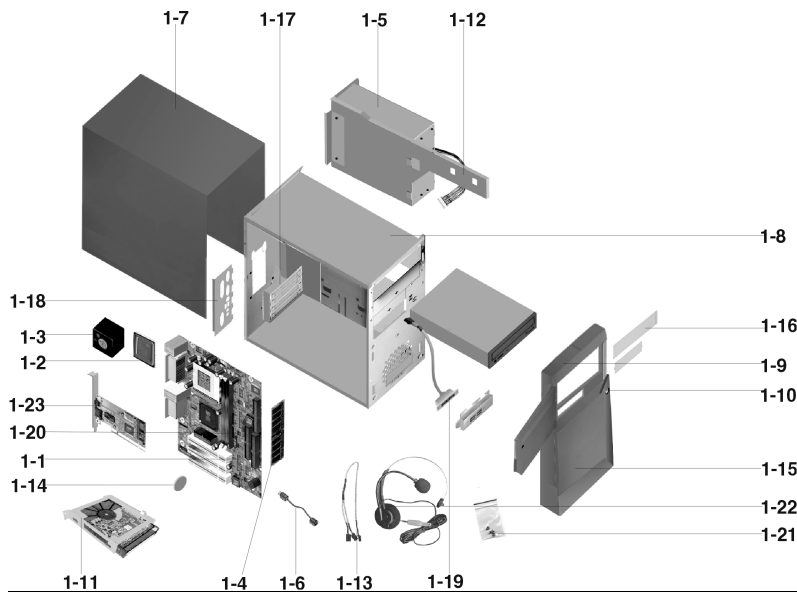

Asm-Index	FRU Number	Description
1-1	31P5472	MSI-6188 810E
1-1	31P5464	MSI-6188 810E w/2 Serial Ports
1-2	22P2265	INTEL Celeron 566MHz 66FSB
1-2	19K3386	INTEL Celeron 600MHz 66FSB
1-2	22P2266	INTEL Celeron 633MHz 66FSB
1-2	22P2269	INTEL Celeron 667MHz 66FSB
1-2	22P2423	INTEL Celeron 700MHz 66FSB
1-2	22P2308	INTEL Celeron 733MHz 66FSB
1-2	24P6043	INTEL Celeron 766MHz 66FSB
1-2	22P2267	INTEL PIII 733MHz
1-2	22P2268	INTEL PIII 800MHz
1-2	22P2309	INTEL PIII 866MHz
1-2	24P6011	INTEL PIII 933MHz
1-2	24P6010	INTEL PIII 1GHz
1-3	19K3292	Fansink, Supports PIII Processors and Celeron 600 and up
1-3	24P6009	Fansink, Support 933MHz/1GHz PIII Processors
1-4	19K3293	64MB module (PC133)
1-4	19K3294	128MB module (PC133)
1-5	00N7685	155W Power Supply 4X3 Non-PFC

1-5	00N7689	155W Power Supply 4X3 China
1-5	00N7687	155W Power Supply 4X3 Japan/EMEA
1-6	6952301	Power Cord US, LA (Lo Volt), Canada, Mexico, Peru, Colombia, Ecuador, Venezuela, Bolivia, Panama, El Salvador, Honduras, Nicaragua, Dominican Republic, Guatemala, Taiwan, Saudi Arabia, Thailand
1-6	36L8879	Power Cord APU Countries
1-6	14F0032	Power Cord UK/HK/Singapore/United Arab Emirate (Dubai)
1-6	13F9978	Power Cord (Euro) France, Germany, Sweden, Norway, Netherlands, Finland, Belgium, Bosnia, Croatia, Egypt, Greece, Hungary, Poland, Portugal, Romania, Slovenia, Spain, Sweden, Turkey, LA (HI Volt)
1-6	14F0050	Power Cord Swiss
1-6	13F9996	Power Cord Denmark
1-6	14F0068	Power Cord Italy, Chile
1-6	14F0086	Power Cord Israel
1-6	14F0014	Power Cord South Africa
1-6	02K0545	Power Cord China
1-6	13F9939	Power Cord ANZ
1-6	36L9015	Power Cord Japan
1-7	19K7810	Top cover, Black
1-8	19K7811	Chassis Asm
1-9	19K7812	Front Bezel Asm, Black
1-10	19K7813	Power Button
1-11	22P2315	HDD Mounting Bracket
1-12	37L2502	Power Supply Bracket
1-13	19K7814	LED/Power Switch Asm
1-14	03K9655	Foot
1-15	19K7815	Door Asm
1-16	09N1749	Blank Bezel 5.25" BAY – Black
1-17	22P2316	Planar I/O EMC Shield
1-17	24P6049	Planar I/O Port EMC Shield, Used w/MSI-6188 810E Planar, Tower Mdl's w/2 Serial Ports
1-18	20L3073	EMC Shield for 5.25" Bay
1-19	09N5729	Dual USB Cable
1-20	36L9077	CMOS Backup Battery (CR2032)
1-21	09N5764	Misc. Hardware Kit
1-22	19K3312	Andrea Noise Cancelling, NC8
1-23	19K4309	Accton Ethernet Card 10/100 WOL
1-23	34L1209	Lake Clark 2.3
1-24	22P2406	LED/Power Switch Asm Cable Adapter, Connects LED/Power Switch Asm to planar

Assembly 2: Diskette Drive, Hard Disk Drive

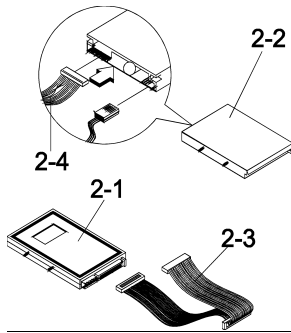

Asm-Index	FRU Number	Description
2-1	10K2059	10GB HDD, 3.5"
2-1	19K3299	15GB HDD, 3.5"
2-1	19K3355	20GB HDD, 3.5"
2-1	19K1561	30GB HDD, 3.5" 5400 RPM, ATA66
2-1	24P6001	10GB HDD, 3.5", 5400 RPM, ATA 100 , 20GB/Platter
2-1	24P6003	20GB HDD, 3.5", 5400 RPM, ATA 100 , 20GB/Platter
2-1	24P6004	30GB HDD, 3.5", 5400 RPM, ATA 100 , 20GB/Platter
2-1	24P6005	40GB HDD, 3.5", 5400 RPM, ATA 100 , 20GB/Platter
2-2	76H4091	3.5", FDD, 2 Mode, Black Bezel
2-3	37L4525	HDD Cable- ATA 66/100
2-4	01K1513	Diskette Drive Cable

Assembly 3: CD-ROM, Modem Card

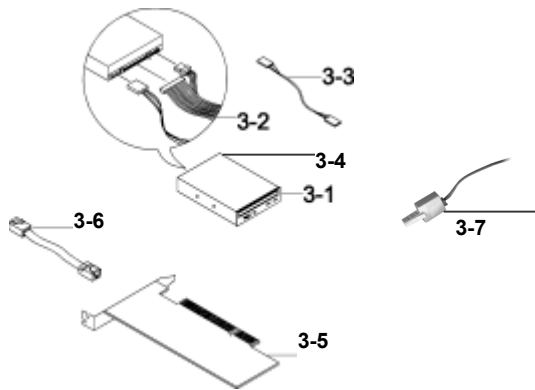

Asm-Index	FRU Number	Description
3-1	19K3643	48X CD-ROM, Black Bezel
3-1	22P2448	8X4X32X CD-RW, Black Bezel
3-1	19K3413	4X4X32X CD-RW, Black Bezel
3-2	19K3358	CD-ROM Cable
3-3	09N5406	CD-ROM Audio Cable (for MSI board)
3-3	19K3580	CD-ROM Audio 'Y' Cable
3-4	22P2404	12X-40X DVD-ROM, Black Bezel
3-4	19K3350	8X-40X DVD-ROM, Black Bezel
3-5	22P2428	Modem 56K, For MT GVC F-1156IV/R9C, Argentina (APU) (Low profile modem with full height bracket)
3-5	22P2288	Modem 56K, For MT Askey, 1456VQH87, NA/LA/SA/Japan/China/TW/HK, (Low profile modem with full height bracket)
3-5	22P2289	Modem, 56K, For MT GVC WT, F-1156IV+/R9C, EMEA/ANZ/Singapore/India (Low profile modem with full height bracket) Askey,1456VQH87 (INT1), EMEA/ANZ/Singapore/India, (Low profile modem with full height bracket)
3-6	36L9016	7FT Phone Cord
3-7	01N1872	Modem Phone Cable Adapter Australia
3-7	01N1874	Modem Phone Cable Adapter New Zealand
3-7	60H6043	Modem Phone Cable Adapter, Spain/Southern Ireland

3-7	60H6045	Modem Phone Cable Adapter, Austria
3-7	60H6046	Modem Phone Cable Adapter, Belgium
3-7	60H6047	Modem Phone Cable Adapter, Denmark
3-7	60H6048	Modem Phone Cable Adapter, Norway/Finland
3-7	60H6049	Modem Phone Cable Adapter, France
3-7	60H6050	Modem Phone Cable Adapter, Germany
3-7	60H6051	Modem Phone Cable Adapter, UK/Northern Ireland
3-7	60H6052	Modem Phone Cable Adapter, Italy
3-7	60H6053	Modem Phone Cable Adapter, Netherlands
3-7	60H6054	Modem Phone Cable Adapter, Sweden
3-7	60H6055	Modem Phone Cable Adapter, Switzerland

Assembly 4: Keyboard and Mouse

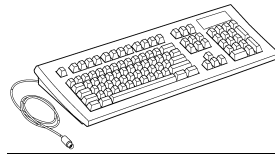

4-2



4-4

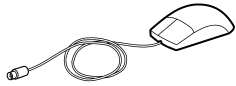

4-1

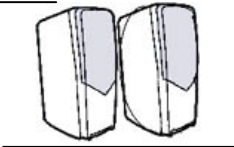

4-3

Asm-Index	FRU Number	Description
4-1	10L6149	Logitech Badger (2 Button), Black
4-1	28L1868	Scroll Point II, Black
4-2	37L2551	104 PALM REST US ENG 103P US/China/ANZ/Singapore
4-2	37L0913	105 PALM REST FR CANADIAN 058, Commercial
4-2	37L2553	105 PALM REST LA SPANISH 171
4-2	37L2555	105 PALM REST ARABIC 253
4-2	37L2556	105 PALM REST, EURO BELGIUM/FR 120
4-2	37L2557	105 PALM REST, EURO BELGIUM/UK 120
4-2	37L2558	105 PALM REST BULGARIAN 442
4-2	37L2559	105 PALM REST, EURO CZECH 243
4-2	37L2560	105 PALM REST, EURO DANISH 159
4-2	37L2561	105 PALM REST, EURO DUTCH 143
4-2	37L2562	105 PALM REST, EURO FRENCH 189
4-2	37L2563	105 PALM REST, EURO GERMAN 129
4-2	37L2564	105 PALM REST, EURO GREEK 319
4-2	37K2565	104 PALM REST HEBREW 212
4-2	37L2566	105 PALM REST, EURO HUNGARIAN 208
4-2	37L2567	105 PALM REST, EURO ICELAND 197
4-2	37L2568	105 PALM REST, EURO ITALY 142
4-2	37L2569	105 PALM REST, EURO NORWEGIAN 155

4-2	37L2570	105 PALM REST, EURO POLISH 214
4-2	37L2571	105 PALM REST, EURO PORTUGUESE 163
4-2	37L2572	105 PALM REST, ROMANIAN 446
4-2	37L2573	104 PALM REST, RUSSIAN 443
4-2	37L2574	105 PALM REST, EURO SERBIAN/CYR 118
4-2	37L2575	105 PALM REST, EURO SLOVIC 245
4-2	37L2576	105 PALM REST, EURO SPANISH 172
4-2	37L2577	105 PALM REST, EURO SWED/FINN 153
4-2	37L2578	105 PALM REST, EURO SWISS 150
4-2	37L2579	105 PALM REST, EURO TURKISH 179
4-2	37L2580	105 PALM REST, EURO TURKISH 440
4-2	37L2581	105 PALM REST, EURO UK ENG 166
4-2	37L2582	105 PALM REST, EURO YUGOSL/LAT 234
4-2	37L2583	104 PALM REST, US ENG- EMEA
4-2	37L2585	104 PALM REST, CHINESE/US 467 HK/TW
4-2	37L2587	104 PALM REST, THAILAND 191
4-2	37L2613	104 US ENGLISH 103P, US/CE
4-2	37L2635	105 FR CANADIAN 445, Consumer
4-2	37L2615	105 LA SPANISH 171
4-2	37L2617	105 ARABIC 253
4-2	37L2618	105 BELGIUM UK 120, EURO
4-2	37L2619	105 DANISH 159, EURO
4-2	37L2620	105 DUTCH 143, EURO
4-2	37L2621	105 FRENCH 189, EURO
4-2	37L2622	105 GERMAN 129, EURO
4-2	37L2623	105 GREEK 319, EURO
4-2	37L2624	105 ITALIAN 142, EURO
4-2	37L2625	105 NORWEGIAN 155, EURO
4-2	37L2626	105 PORTUGUESE 163, EURO
4-2	37L2627	105 SPANISH 172, EURO
4-2	37L2628	105 SWEDDISH/FINNISH 153, EURO

4-2	37L2629	105 SWISS 150, EURO
4-2	37L2630	105 UK ENGLISH 166, EURO
4-2	37L2634	105 BELGIUM FRENCH 120, EURO
4-3	22P2313	External Speaker Set, Active, Cyber Acoustics, Tier 4, Black
4-4	10K2587	Speaker Power Adapter, US, LA (Lo Volt), Canada, Mexico, Peru, Colombia, Ecuador, Venezuela, Bolivia, Panama, El Salvador, Honduras, Nicaragua, Dominican Republic, Guatemala, Taiwan, Saudi Arabia, Thailand, Used with Cyber Acoustics/Tier 1 speakers

Parts Catalog of Machine Types 6266 and 6286

Assembly 1: System Unit

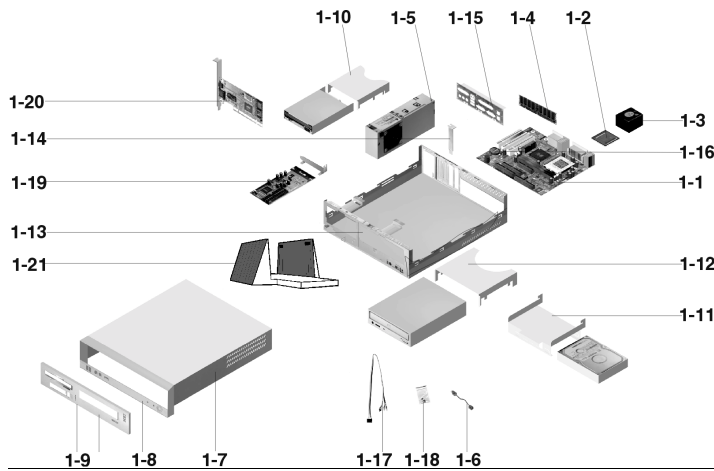

Asm-Index	FRU Number	Description
1-1	31P5472	MSI-6188 810E
1-1	31P5464	MSI-6188 810E w/2 Serial Ports
1-2	22P2265	INTEL Celeron 566MHz 66FSB
1-2	19K3386	INTEL Celeron 600MHz 66FSB
1-2	22P2266	INTEL Celeron 633MHz 66FSB
1-2	22P2269	INTEL Celeron 667MHz 66FSB
1-2	22P2423	INTEL Celeron 700MHz 66FSB
1-2	22P2308	INTEL Celeron 733MHz 66FSB
1-2	24P6043.	INTEL Celeron 766MHz 66FSB
1-2	22P2267	INTEL PIII 733MHz 133FSB
1-2	22P2268	INTEL PIII 800MHz 133FSB
1-2	22P2309	INTEL PIII 866MHz 133FSB
1-2	24P6011	INTEL PIII 933MHz 133FSB
1-2	24P6010	INTEL PIII 1GHz 133FSB
1-3	19K3292	Fansink, Supports PIII Processors and Celeron 600 and up
1-3	24P6009	Fansink, Supports 933MHz/1GHz Coppermine, PIII Processors
1-4	19K3293	64MB module (PC133)
1-4	19K3294	128MB module (PC133)
1-5	19K3585	95W Power Supply, used w/MSI-6188 810E Planar
1-6	6952301	Power Cord US, LA (Lo Volt), Canada, Mexico, Peru, Colombia, Ecuador, Venezuela, Bolivia, Panama, El Salvador, Honduras, Nicaragua, Dominican Republic, Guatemala, Taiwan, Saudi Arabia, Thailand
1-6	13F9939	Power Cord Brazil
1-6	14F0032	Power Cord UK/HK/Singapore/United Arab Emirate (Dubai)

1-6	13F9978	Power Cord (Euro) France, Germany, Sweden, Norway, Netherlands, Finland, Belgium, Bosnia, Croatia, Egypt, Greece, Hungary, Poland, Portugal, Romania, Slovenia, Spain, Sweden, Turkey, LA (HI Volt)
1-6	14F0050	Power Cord Swiss
1-6	13F9996	Power Cord Denmark
1-6	14F0068	Power Cord Italy, Chile
1-6	14F0086	Power Cord Israel
1-6	14F0014	Power Cord South Africa
1-6	02K0545	Power Cord China
1-6	13F9939	Power Cord ANZ
1-6	36L9015	Power Cord Japan
1-7	31P5607	Top Cover, SFF
1-7	58P9863	Top Cover, Black
1-8	22P2273	Main Bezel, Includes FDD Cover and CD-ROM Blank, White, SFF, NetVista (new style)
1-8	22P2278	Main (Bezel) Panel, NetVista, White
1-8	22P2314	Main Bezel includes FDD Cover and CD-ROM Blank, SFF, NetVista, Black
1-8	24P6046	Main Bezel includes FDD Cover and CD-ROM Blank, SFF, NetVista (new style) White
1-9	19K3430	Outer (Bezel) Panel w/FDD slot and Knock-out for CD-ROM slot, SFF, (old style), White
1-10	19K3642	FDD DASD (Holder) Bracket, does not support PCMCIA, SFF
1-11	19K3328	HDD DASD (Holder) Bracket, SFF
1-12	19K3329	CD-ROM DASD (Holder) Bracket, SFF
1-13	32P4063	Chassis (wo/power supply), SFF
1-13	31P5611	Chassis w/o power supply, black base
1-14	19K3333	Port Bracket LP/PCI, SFF
1-15	19K3591	Planar I/O Port EMC Shield (includes label), Used w/MSI-6188 810E Planar
1-15	24P6048	Planar I/O Port EMC Shield, Used w/MSI-6188 810E planar, w/2 Serial Ports
1-16	36L9077	CMOS Backup Battery (CR2032)
1-17	19K3579	HDD-PWR LED/PWR Switch Cable Asm, Used w/MSI-6188 810E Planar
1-18	19K3346	Screw Pack, SFF
1-19	19K4209	Lake Clark 2.4 (Low Profile Bracket)
1-20	19K4309	Accton Ethernet Card
1-21	19K3347	System stand, metallic blue
1-21	24P6054	System Stand, white, Japan

Assembly 2: Diskette Drive, Hard Disk Drive

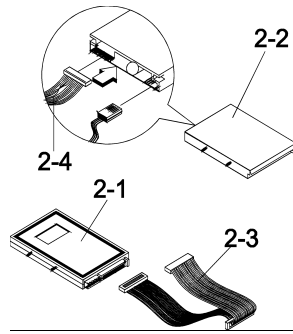

Asm-Index	FRU Number	Description
2-1	10K2059	10 GB Hard Disk Drive, 3.5"
2-1	24P6001	10GB Hard Disk Drive, 3.5", 5400 RPM, ATA 100, 20GB/Platter
2-1	19K3355	20GB Hard Disk Drive, 3.5"
2-1	24P6003	20GB Hard Disk Drove, 3.5", 5400 RPM, ATA 100, 20GB/Platter
2-2	36L9130	3.5", Diskette Drive
2-3	19K3341	Hard Disk Drive Cable
2-4	19K3340	Diskette Drive Cable

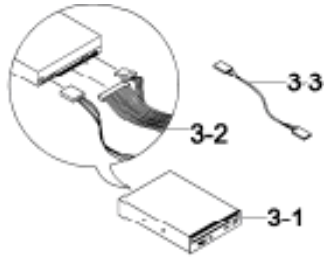
Assembly 3: CD-ROM, Modem Card

Asm-Index	FRU Number	Description
3-1	19K3360	40X CD-ROM, White Bezel
3-1	19K3300	48X CD-ROM Drive, White
3-1	19K3643	48X CD-ROM Drive, Black
3-2	19K3342	CD-ROM Cable
3-3	09N5406	CD-ROM Audio Cable (for MSI board)

Assembly 4: Keyboard and Mouse

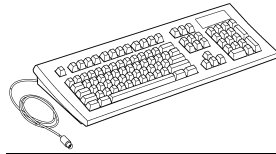

4-2

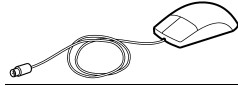

4-1

Asm-Index	FRU Number	Description
4-1	10L6145	Mouse, Badger
4-1	10L6149	2-Button Mouse, Black
4-2	37L2514	104 PALM REST US ENG 103P US/CHINA/ANZ/Singapore
4-2	37L0912	105 PALM REST FR CANADIAN 058(Commercial)
4-2	37L2516	105 PALM REST, LA SPANISH 171
4-2	37L2518	105 PALM REST, ARABIC 275
4-2	37L2519	105 PALM REST, EURO BELGIUM/FR 120
4-2	37L2520	105 PALM REST, EURO BELGIUM/UK 120
4-2	37L2521	105 PALM REST BULGARIAN 442
4-2	37L2522	105 NO PALM REST CZECH 243
4-2	37L2523	105 PALM REST, EURO DANISH 159
4-2	37L2524	105 PALM REST, EURO DUTCH 143
4-2	37L2525	105 PALM REST, EURO FRENCH 189
4-2	37L2526	105 PALM REST, EURO GERMAN 129
4-2	37L2527	105 PALM REST, EURO GREEK 319
4-2	37L2528	104 PALM REST, HEBREW 212
4-2	37L2529	105 PALM REST HUNGARIAN 208
4-2	37L2530	105 PALM REST, ICELANDIC 197
4-2	37L2531	105 PALM REST, EURO, ITALY 142
4-2	37L2532	105 PALM REST, EURO, NORWEGIAN 155
4-2	37L2533	105 PALM REST, POLISH 214
4-2	37L2534	105 PALM REST, PORTUGUESE 163

4-2	37L2535	105 PALM REST, ROMANIAN 446
4-2	37L2536	104 PALM REST, RUSSIAN 443
4-2	37L2537	105 PALM REST, SERBIAN/CYR 118
4-2	37L2538	105 PALM REST, SLOVIC 245
4-2	37L2539	105 PALM REST, EURO SPANISH 145
4-2	37L2540	105 PALM REST, EURO SWED/FINN 153
4-2	37L2541	105 PALM REST, EURO SWISS 150
4-2	37L2542	105 PALM REST, TURKISH 179
4-2	37L2543	105 PALM REST, TURKISH 440
4-2	37L2544	105 PALM REST, EURO UK ENG 166
4-2	37L2545	105 PALM REST YUGOSL/LAT 234
4-2	37L2546	104 PALM REST, US ENG, EMEA, ANZ
4-2	37L2548	104 PALM REST, CHINESE/US 467, HK/TW
4-2	37L2550	104 PALM REST, THAILAND 191
4-2	37L2517	107 PALM REST, BRAZILIAN/PORTUGUESE 275
4-2	37L2547	109 PALM REST, JAPANESE 194
4-2	28L1860	KOREAN 413
4-2	37L2251	104 PALM REST, US ENG 103P US/CHINA/ANZ/Singapore, Black
4-2	37L0913	105 PALM REST, FR CANADIAN 058, Commercial
4-2	37L2553	105 PALM REST LA SPANISH 171

Appendix A. Online Support Information

This section describes online technical support services available to help repair the computer.

This section covers:

- IBM PC Company Fax-Back Service
- IBM useful sites on the World Wide Web (WWW)
- IBM Online Assistant
- Discussion Forums

The IBM PC Company offers online resources including several Internet World Wide Web sites, the IBM Online HelpCenter support areas, and a Fax-Back service.

The IBM Automated Fax-Back System offers a variety of IBM computer-related articles. To access this service, call 800-IBM-3395. The Fax-Back system file library can also be accessed through the PC Company BBS.

The IBM Online Assistant will help you to diagnose and resolve technical problems by giving you access to the same tools used by IBM PC HelpCenter specialists. IBM Online Assistant guides you from symptom to resolution, by asking simple questions based on the collective experience of IBM senior support specialists. In addition many recommended next steps link to the extensive IBM online library, providing access to supporting information during the diagnostic process. To access the Online Assistant go to the IBM support web site, (<http://www.ibm.com/support>) press the profile button and set up your personal profile. Your profile will give you access to the IBM Online Assistant through your personalized page.

For other technical questions your personalized page will also give you access to IBM Discussion Forums. The forums are monitored by IBM HelpCenter technicians to answer your technical questions.

Here are useful IBM Internet addresses for information:

<http://www.ibm.com/support>

IBM Home Page on the World Wide Web

Index

A

- Adapter Cards
 - Installing, 82
 - Removing, 82
- Audio
 - Check Procedure, 62
 - Error Symptoms, 56

B

- Beeps 46, 50, 82
- BIOS
 - Flash (BIOS/VPD)
update procedure, 34
 - BIOS Setup Utility, 34

C

- Cabling, 30
- CD-ROM Drive
 - 30, 32, 84, 108
 - Check Procedure, 63
 - Connectors and Features, 108
 - Emergency-exit, 108
 - Error Symptoms, 133
 - Front Panel, 108
 - Jumper Settings, 109
 - CMOS Reset, 33

D

- Diagnostic Aids, 71
- Diagnostic Diskette, 74
- Diagnostic Program
 - Error symptoms, 57
- Diagnostic Program
 - Using from Recovery CD, 74
- Diagnostic Tools, 74
- Diskette Drive, 29, 32, 83
 - Connector Signals, 113
- Error Symptoms, 54

E

- Electrical Input, 41
- Error Codes, 50, 50
- Error Messages, 50, 50
- Error Symptoms, 50, 54
- External Ports, 29
 - Parallel Port, 32
 - Serial Port, 32
 - USB port, 32

F

- Fan
 - Error Symptoms 54, 66

H

- Hard Disk Drive 30, 85
 - 3.5-In. Jumper Locations & Settings, 107
 - 32-bit Access, 32
 - Check Procedure, 55
 - Error Symptoms, 55
 - Hard Disk Drive, 32

I

IDE

- Connector Signals, 114

J

- Joystick, 29, 75
- Error Symptoms, 57

K

- Keyboard, 64
 - Check Procedure, 64
 - Error Symptoms, 57
- Keyboard Port
 - Port Signals, 111

M

- Memory, 29
 - Check Procedure, 64
- DIMM Configurations, 110
- Error Symptoms, 54
- Modem, 30
 - Check Procedure, 61
 - Connector Functions, 106
- Layout, 106
- Monitor, 68
 - Check Procedure, 68
 - Error Symptoms, 56
 - Port Signals, 111
- Mouse, 64
 - Check Procedure, 65
- Mouse Port
 - Port Signals, 111
- Multimedia, 30

O

- Online Support Information, 118

P

- Parallel Port, 32
 - Error Symptoms, 57
 - Port Signals, 111
- Parts Catalog of Machine Type, 117
 - CD-ROM, Modem Card, 121, 129
 - Diskette Drive, Hard Disk Drive, 121, 128
 - Keyboard and Mouse, 123, 130
- System Unit, 118, 126
- Parts/Test Point Locations, 99
- PCI, 32
- Plug and Play, 39
- POST, 47
- Power Consumption, 41
- Power Management, 30, 39
- Power Supply, 30
 - Check Procedure, 66
 - Connector Specifications, 101
 - Error Symptoms, 54
- Processor
 - Error Symptom, 54

R

- Real-Time Clock
 - Error Symptoms 56
- Repair Information, 77
- Removals and Replacements, 78, 89
 - Adapter Cards, 82, 92
- CD-ROM Drive, 84, 94
 - Diskette Drive, 83, 93
 - Hard Disk Drive, 85, 95
 - System Board, 86, 96
 - Top Cover, 81, 91

S

- Safety Inspection Guide, 115
- Serial Port, 29, 32, 38
 - Error Symptoms, 57
 - Port Signals, 111
- Specifications, 41
 - Dimensions, 41
 - Electrical Input, 41
 - Environment, 41
 - Power Consumption, 41
 - Weight, 41
- System Board
 - Connectors and Functions of System Board of Machine Types 6266, 6270, 6276, 6279, 6280 and 6286, 101
 - Error Symptoms, 54

T

- Tools, 43

U

- Undetermined Problems
 - Check Procedure, 69
- USB, 32



Printed in U.S.A.

International Business Machines Corporation
Old Orchard Road,
Armonk, New York 10504

Part Number: 06P1789
Pub Number: S06P-1789-01
1/01