

Personal Systems Reference Version 350 - January 2009

SATA disk	80 or 160GB / SATA150 / 7200 rpm / vibration /	L2 cache	2MB / on die (at processor speed) / ECC	Intel Pentium 4 Processor
SATA controller	Serial ATA 1.0 / 300 MB/sec SATA300 / Integr	Memory	512MB std / 2GB max* / PC2-4200 / 533MHz DDR2 / non-parity / CL4 / dual ch	Intel Pentium 4 Processor
SATA cables	One SATA cable (one 1-drop to disk) / 4 SATA	Diskette drive	None standard / use optional USB-based diskette drive	Intel Pentium 4 Processor
EIDE Combo	Some: 48X/32X/48X/6X Max* / CD-RW/DVE	Combo	DVD-ROM/CD-RW / 24X/24X/24X/8X* speed / removable from Ultrabay Slim	Intel Pentium 4 Processor
EIDE DVD-RW	Some: 8X/4X and CD burner / Multi-Super-It	Ultrabay Slim	One modular bay for interchangeable devices (right side) / 9.5mm high bay	Intel Pentium 4 Processor
EIDE controller	Enhanced IDE / ATA-100 / Integrated in I/O Ch	Serial ATA disk	60GB* (5400 rpm) / 9.5mm high / removable and upgradable / 9.5mm high ba	Intel Pentium 4 Processor
EIDE cables	One 2-drop EIDE cable to optical / one connec	(SATA150)	supports 2nd disk / HDD Protection Pack (shock absorber) /	Intel Pentium 4 Processor
Diskette drive	3.5" 1.44MB diskette drive	Active Protection System**		Intel Pentium 4 Processor
Chipset	Intel 945G Express Chipset / 82945G Graph	Display	Widescreen / 14.0" (355.4mm) WXGA (1280x768) TFT color / 200 nits / 15"	Intel Pentium 4 Processor
Front ports	Two USB (Version 2.0), microphone, stereo, 3	Graphics	stainless steel hinges / one hand activated dual latch / secure screen surro	Intel Pentium 4 Processor
Rear ports	Six USB (Version 2.0), one 9-pin serial, parall	Keyboard	Intel Graphics Media Accelerator 900 (GMA 900) / integrated graphics in 9	Intel Pentium 4 Processor
Audio	Line-in (stereo), line-out (stereo), 3.5mm	TrackPoint*	GMCH / uses main memory (up to 128MB with 256MB+) / 200MHz	Intel Pentium 4 Processor
Speakers	High Definition Audio / 2 x 2W / 2.5"	TrackPoint	89-key / ThinkVantage button / spill-resistant / multimedia Fn keys / Window	Intel Pentium 4 Processor
External ports	One internal / one external / 12-pin	TrackPoint	illumination / improves visibility in low light conditions	Intel Pentium 4 Processor
Ethernet	Gigabit Ethernet / Intel 82579L / 10/100/1000	Case	WVGA / 14.0" (355.4mm) WXGA (1280x768) TFT color / 200 nits / 15"	Intel Pentium 4 Processor
Modern Security chip	Intel vPro / Intel vPro / Intel vPro	Battery	Black acrylic / 1.2mm / 228mm x 25.6	Intel Pentium 4 Processor
Keyboard	ThinkVantage / ThinkVantage / ThinkVantage	Battery	Black acrylic / 1.2mm / 228mm x 25.6	Intel Pentium 4 Processor
Mouse	ThinkVantage / ThinkVantage / ThinkVantage	Battery	Black acrylic / 1.2mm / 228mm x 25.6	Intel Pentium 4 Processor
Docking base	ThinkVantage / ThinkVantage / ThinkVantage	Battery	Black acrylic / 1.2mm / 228mm x 25.6	Intel Pentium 4 Processor
Power supply	ThinkVantage / ThinkVantage / ThinkVantage	Battery	Black acrylic / 1.2mm / 228mm x 25.6	Intel Pentium 4 Processor

Personal Systems Reference (PSREF) - Index - Version 350

Index	Sheet Name	Date on Bottom	Title	Sheet Name	Date on Bottom
☞ Personal Systems Reference - Index	INDEX	Jan 09			
☞ Index - Withdrawn Products	INDEXW**	Jan 09			
ThinkPad Notebooks (Version 350)	<i>tabook.pdf</i>				
ThinkPad Accessories photography	ACC-P	Oct 08	ThinkPad T500 photography	CR5-P	Aug 08
ThinkPad R61e 15W (GMA Graphics) - 1-year	KON11-2	Jul 07	☞ ThinkPad T500 2242 (GMA) - TopSeller	CR5-1	Jan 09
<i>ThinkPad R61e 15W Accessories</i>	O-R61E	Nov 08	ThinkPad T500 2243 (GMA) - TopSeller	CR5-11	Dec 08
ThinkPad R61 14W 7733 (GMA) - Linux	LAG1-9	Jan 08	☞ ThinkPad T500 2082 (Switchable) - TopSeller	CR5-2	Jan 09
ThinkPad R61 14W (GMA)	LAG1-3	Dec 07	ThinkPad T500 2089 (GMA)	CR5-3	Dec 08
ThinkPad R61 14W 7735 (GMA) - Onsite	LAG1-11	Feb 08	ThinkPad T500 2055 (Switchable)	CR5-4	Dec 08
ThinkPad R61 14W (GMA) - Education (EasyServ)	LAG1-5	May 07	ThinkPad T500 2241 (GMA) - Onsite	CR5-5	Dec 08
ThinkPad R61 14W (GMA) - Education (Onsite)	LAG1-6	May 07	ThinkPad T500 2056 (Switchable) - Onsite	CR5-6	Dec 08
ThinkPad R61u 14W 7733 (GMA) - Ed (EasyServ)	LAG2-1	Apr 08	ThinkPad T500 2089 (GMA) - Educ (EasyServ)	CR5-7	Dec 08
ThinkPad R61u 14W 7733 (GMA) - Ed (ES) - Linux	LAG2-3	Feb 08	ThinkPad T500 2055 (Switchable) - Ed (EasyServ)	CR5-8	Aug 08
ThinkPad R61u 14W 7743 (NVIDIA) - Ed (EasyS)	LAG2-2	Apr 08	ThinkPad T500 2241 (GMA) - Education (Onsite)	CR5-9	Dec 08
ThinkPad R61u 14W 7743 (NVIDIA) - Ed (ES) - Lin	LAG2-4	Feb 08	ThinkPad T500 2056 (Switchable) - Educ (Onsite)	CR5-10	Aug 08
<i>ThinkPad R61 14W Accessories</i>	O-R61-14W	Nov 08	ThinkPad W500 photography	CR5W-P	Aug 08
ThinkPad R61 15W (GMA) - 3-year (TopSeller)	WKK11-2	Aug 08	☞ ThinkPad W500 4062 (Switchable) - TopSeller	CR5W-1	Sep 08
ThinkPad R61u 15W 8933 (GMA) - Ed (EasyServ)	WKK2-1	Feb 08	ThinkPad W500 4061 (Switchable)	CR5W-2	Sep 08
<i>ThinkPad R61 15W Accessories</i>	O-R61-15W	Nov 08	☞ ThinkPad W500 4063 (Switchable) - Onsite	CR5W-3	Nov 08
ThinkPad R61i 14W 7732 (GMA) - TopS (Mar 08)	B-LAG1-2	Aug 08	<i>ThinkPad T500, W500 Accessories</i>	O-T500	Nov 08
ThinkPad R61i 15W 7650 (GMA) - TopSeller	B-KON11-1	Jul 08	ThinkPad W700 photography	NIC1-P	Sep 08
ThinkPad R61i 15W 8932 (GMA) - TopS (Jan 08)	B-WKK11-2	Jul 08	☞ ThinkPad W700 2758 (TopSeller)	NIC1-1	Aug 08
ThinkPad R400 photography	LAG3-P	Aug 08	ThinkPad W700 2752	NIC1-2	Aug 08
ThinkPad R400 7438 (TopSeller)	LAG3-1	Aug 08	ThinkPad W700 2752 (Extreme)	NIC1-3	Aug 08
ThinkPad R400 7439	LAG3-2	Dec 08	☞ ThinkPad W700 2752 (Quad-Core Extreme)	NIC1-4	Aug 08
ThinkPad R400 7440 (Onsite)	LAG3-3	Dec 08	ThinkPad W700 2753 (Onsite)	NIC1-5	Aug 08
ThinkPad R400 7439 (Education) - EasyServ	LAG3-4	Dec 08	☞ ThinkPad W700ds photography	NIC15-P	Jan 09
ThinkPad R400 7440 (Education) - Onsite	LAG3-5	Aug 08	☞ ThinkPad W700ds 2752	NIC15-1	Jan 09
<i>ThinkPad R400 Accessories</i>	O-R400	Nov 08	☞ ThinkPad W700ds 2753 (Onsite)	NIC15-2	Jan 09
ThinkPad R500 photography	WKK3-P	Aug 08	<i>ThinkPad W700 Accessories</i>	O-W700	Nov 08
ThinkPad R500 2717 (TopSeller)	WKK3-1	Aug 08	ThinkPad X61 (7675) - TopSeller	SM3-1	Mar 08
ThinkPad R500 2716	WKK3-2	Sep 08	ThinkPad X61 (7673)	SM3-2	Feb 08
ThinkPad R500 2718 (Onsite)	WKK3-3	Sep 08	ThinkPad X61s (7669) - TopSeller	KB3-1	Sep 07
ThinkPad R500 2716 (Education)	WKK3-4	Sep 08	ThinkPad X61s (7666)	KB3-2	Feb 08
<i>ThinkPad R500 Accessories</i>	O-R500	Nov 08	ThinkPad X61s (7667) - Onsite	KB3-3	Feb 08
ThinkPad T61 14W 7658 (GMA) - TopSeller	ML1-1	May 08	<i>ThinkPad X60 and X61 Series Accessories</i>	O-X60	Nov 08
ThinkPad T61 14W 7664 (NVIDIA) - TopSeller	ML1-2	Aug 08	ThinkPad X61 Tablet (7762)	DL2-2	Jun 08
ThinkPad T61u 14W 7659 (GMA) - Educ (EasyServ)	ML2-1	Apr 08	ThinkPad X61 Tablet (7762) - Onsite	DL2-6	Feb 08
ThinkPad T61u 14W 7659 (GMA) - Educ (Linux)	ML2-3	Feb 08	ThinkPad X61 Tablet (7767) - TopSeller (3-year)	DL2-3	Sep 07
ThinkPad T61u 14W 7663 (NVIDIA) - Ed (EasySrv)	ML2-2	Apr 08	ThinkPad X61 Tablet (Education) - EasyServ	DL2-4	Jul 07
ThinkPad T61u 14W 7663 (NVIDIA) - Educ (Linux)	ML2-4	Feb 08	ThinkPad X61 Tablet (Education) - Onsite	DL2-5	Jul 07
ThinkPad T61 15W (GMA Graphics)	CR3-2	May 07	<i>ThinkPad X60 Tablet and X61 Tablet Accessories</i>	O-X60-T	Nov 08
ThinkPad T61 15W 6464 (GMA) - Onsite	CR3-14	Feb 08	ThinkPad X200 photography	MOC1-P	Sep 08
ThinkPad T61 15W 6460 (NVIDIA) - TopSeller	CR3-9	Sep 08	☞ ThinkPad X200 (7454) - TopSeller	MOC1-1	Jan 09
ThinkPad T61 15W (NVIDIA Graphics)	CR3-5	Mar 08	☞ ThinkPad X200 (7458)	MOC1-2	Jan 09
ThinkPad T61 15W 6458 (NVIDIA) - Onsite	CR3-12	Feb 08	ThinkPad X200 (7458) - December 2008	MOC1-6	Dec 08
ThinkPad T61 15W 6457 (NVIDIA) - Educ (EasyS)	CR3-7	Feb 08	ThinkPad X200 (7459) - Onsite	MOC1-3	Oct 08
ThinkPad T61 15W (NVIDIA) - Educ (Onsite)	CR3-8	Jul 07	ThinkPad X200 (7458) - Education (EasyServ)	MOC1-4	Nov 08
ThinkPad T61u 15W 6463 (GMA) - Ed (EasySrv)	CR4-2	Apr 08	ThinkPad X200 (7459) - Education (Onsite)	MOC1-5	Nov 08
ThinkPad T61u 15W 6457 (NVIDIA) - Ed (EasySrv)	CR4-1	Apr 08	ThinkPad X200s photography	PEC1-P	Sep 08
ThinkPad T61p 15W 6460 (NVIDIA) - TopSeller	CR3-10	Jan 08	ThinkPad X200s (7466) - TopSeller	PEC1-1	Sep 08
ThinkPad T61p 15W 6457 (NVIDIA) - Ed (EasySrv)	CR4-4	Apr 08	ThinkPad X200s (7469)	PEC1-2	Dec 08
<i>ThinkPad T61 Accessories</i>	O-T61	Nov 08	ThinkPad X200s (7470) - Onsite	PEC1-3	Dec 08
ThinkPad T400 photography	ML3-P	Dec 08	<i>ThinkPad X200, X200s Accessories</i>	O-X200	Nov 08
ThinkPad T400 6473 (GMA) - TopSeller	ML3-9	Sep 08	ThinkPad X200 Tablet photography	CML1-P	Sep 08
☞ ThinkPad T400 7417 (GMA) - TopSeller	ML3-1	Jan 09	☞ ThinkPad X200 Tablet (7449) - TopSeller	CML1-1	Oct 08
ThinkPad T400 2765 (Switchable) - TopSeller	ML3-2	Oct 08	ThinkPad X200 Tablet (7450)	CML1-2	Sep 08
ThinkPad T400 6474 (GMA)	ML3-3	Dec 08	☞ ThinkPad X200 Tablet (7450) - December 2008	CML1-6	Jan 09
ThinkPad T400 2767 (Switchable)	ML3-4	Nov 08	ThinkPad X200 Tablet (7453) - Onsite	CML1-3	Sep 08
ThinkPad T400 2767 (Switchable) - October 2008	ML3-10	Dec 08	ThinkPad X200 Tablet (7450) - Educ (EasyServ)	CML1-4	Sep 08
ThinkPad T400 6475 (GMA) - Onsite	ML3-5	Dec 08	ThinkPad X200 Tablet (7453) - Educ (Onsite)	CML1-5	Sep 08
ThinkPad T400 2768 (Switchable) - Onsite	ML3-6	Dec 08	<i>ThinkPad X200 Tablet Accessories</i>	O-X200-T	Nov 08
ThinkPad T400 6474 (GMA) - Education	ML3-7	Aug 08	ThinkPad X300, X301 photography	KOD1-P	Feb 08
ThinkPad T400 2767 (Switchable) - Education	ML3-8	Aug 08	ThinkPad X300 (6478) - TopSeller	KOD1-1	Feb 08
<i>ThinkPad T400 Accessories</i>	O-T400	Nov 08	ThinkPad X300 (6477)	KOD1-2	May 08
			ThinkPad X300 (4052) - Onsite	KOD1-3	Apr 08
			☞ ThinkPad X301 (2776) - TopSeller	KOD2-1	Dec 08
			ThinkPad X301 (2774)	KOD2-2	Dec 08
			ThinkPad X301 (4057) - Onsite	KOD2-3	Sep 08
			<i>ThinkPad X300, X301 Accessories</i>	O-X300	Nov 08
			<i>ThinkPad - ThinkPlus Services</i>	S-TA	Dec 08

Personal Systems Reference (PSREF) - Index - Version 350

Title	Sheet Name	Date on Bottom	Title	Sheet Name	Date on Bottom
ThinkPad SL Notebooks (Version 350)	<i>slbook.pdf</i>		ThinkCentre M57p Ultra Small (9071)	APOL1-6	Feb 08
ThinkPad SL300 photography	CAR1-P	Aug 08	ThinkCentre M57p Ultra Small (9071) - January 08	APOL2-4	Jan 08
ThinkPad SL300 2738 (GMA) - TopSeller	CAR1-1	Dec 08	ThinkCentre M57p Small (9967) - TopSeller	APOL2-9	Sep 08
ThinkPad SL300 2738 (GMA) - TopSeller (Jan 2009)	CAR11-1	Jan 09	ThinkCentre M57p Small (6073)	APOL1-7	Dec 07
ThinkPad SL300 2738 (NVIDIA) - TopSeller	CAR1-2	Dec 08	ThinkCentre M57p Small (6073) - January 2008	APOL2-5	Sep 08
<i>ThinkPad SL300 Series Accessories</i>	O-SL300	Nov 08	ThinkCentre M57p Small (9196) - ES 4.0	APOL1-8	Sep 07
ThinkPad SL400 photography	CAY1-P	Sep 08	ThinkCentre M57p Tower (9979) - TopSeller	APOL2-10	Sep 08
ThinkPad SL400 2743 (GMA) - TopSeller (Celeron)	CAY1-3	Sep 08	ThinkCentre M57p Tower (9088)	APOL1-9	Dec 07
ThinkPad SL400 2743 (GMA) - TopSeller	CAY1-1	Oct 08	ThinkCentre M57p Tower (9088) - January 2008	APOL2-6	Sep 08
ThinkPad SL400 2743 (GMA) - TopSeller (Jan 2009)	CAY11-1	Jan 09	ThinkCentre M57p Tower (9194) - ENERGY STAR	APOL1-10	Sep 07
ThinkPad SL400 2743 (NVIDIA) - TopSeller	CAY1-2	Jul 08	<i>ThinkCentre M57, M57p Accessories</i>	O-M57	Nov 08
<i>ThinkPad SL400 Series Accessories</i>	O-SL400	Nov 08	ThinkCentre M58, M58p photography	MLAN1-P	Nov 08
ThinkPad SL500 photography	TAR1-P	Jul 08	ThinkCentre M58 Eco Ultra Small (8820) - TopSeller	MLAN1-17	Nov 08
ThinkPad SL500 2746 (GMA) - TopSeller (Celeron)	TAR1-3	Jan 09	ThinkCentre M58 Eco Ultra Small (7359)	MLAN1-18	Nov 08
ThinkPad SL500 2746 (GMA) - TopSeller	TAR1-1	Jul 08	ThinkCentre M58p Eco Ultra Small (9961) - TopS	MLAN1-19	Nov 08
ThinkPad SL500 2746 (GMA) - TopSeller (Sep 2008)	TAR1-4	Jan 09	ThinkCentre M58p Eco Ultra Small (7479)	MLAN1-20	Nov 08
ThinkPad SL500 2746 (NVIDIA) - TopSeller	TAR1-2	Jul 08	ThinkCentre M58p Eco Ultra Small (6136) - GMP	MLAN1-21	Nov 08
<i>ThinkPad SL500 Series Accessories</i>	O-SL500	Nov 08	ThinkCentre M58 Small (8910) - TopSeller	MLAN1-3	Oct 08
ThinkCentre Desktops (Version 350)	<i>tcbook.pdf</i>		ThinkCentre M58 Small (7360)	MLAN1-1	Oct 08
ThinkCentre M57e photography	MONA1-P	Feb 08	ThinkCentre M58 Small (6258) - ENERGY STAR 4.0	MLAN1-2	Oct 08
ThinkCentre M57e Small (6305) - TopSeller	MONA2-4	Aug 08	ThinkCentre M58 Small (7638) - GMP	MLAN1-22	Dec 08
ThinkCentre M57e Small (6305) - TopSeller (Oct 08)	MONA3-4	Oct 08	ThinkCentre M58 Tower (9960) - TopSeller	MLAN1-11	Nov 08
ThinkCentre M57e Small (9482)	MONA1-4	Mar 08	ThinkCentre M58 Tower (7373)	MLAN1-9	Nov 08
ThinkCentre M57e Small (9482) - August 2008	MONA2-12	Aug 08	ThinkCentre M58 Tower (6239) - ENERGY STAR 4.0	MLAN1-10	Nov 08
ThinkCentre M57e Small (9482) - Vista	MONA1-1	Feb 08	ThinkCentre M58p Small (9964) - TopSeller	MLAN1-5	Oct 08
ThinkCentre M57e Small (9482) - Vista (Mar 2008)	MONA1-8	Aug 08	ThinkCentre M58p Small (7483)	MLAN1-4	Oct 08
ThinkCentre M57e Small (9482) - Vista (June 2008)	MONA2-1	Aug 08	ThinkCentre M58p Small (7220) - ES 4.0	MLAN1-6	Oct 08
ThinkCentre M57e Small (9482) - Vista (Oct 2008)	MONA3-1	Oct 08	ThinkCentre M58p Small (6137) - GMP	MLAN1-7	Dec 08
ThinkCentre M57e Small (9487) - ENERGY STAR 4.0	MONA1-7	Mar 08	ThinkCentre M58p Small (6234) - ES 4.0 (GMP)	MLAN1-8	Oct 08
ThinkCentre M57e Small (9487) - ES 4.0 (June 2008)	MONA2-2	Aug 08	ThinkCentre M58p Tower (9965) - TopSeller	MLAN1-16	Nov 08
ThinkCentre M57e Small (6178) - ES 4.0 (GMP)	MONA2-3	Jun 08	ThinkCentre M58p Tower (7484)	MLAN1-12	Nov 08
ThinkCentre M57e Small (7066) - GMP	MONA1-11	Mar 08	ThinkCentre M58p Tower (7188) - ES 4.0	MLAN1-13	Nov 08
ThinkCentre M57e Desktop (9481)	MONA1-5	Mar 08	ThinkCentre M58p Tower (6138) - GMP	MLAN1-14	Nov 08
ThinkCentre M57e Desktop (9481) - August 2008	MONA2-13	Aug 08	ThinkCentre M58p Tower (6209) - ES 4.0 (GMP)	MLAN1-15	Nov 08
ThinkCentre M57e Desktop (9481) - Vista	MONA1-2	Mar 08	<i>ThinkCentre M58, M58p Accessories</i>	O-M58	Nov 08
ThinkCentre M57e Desktop (9481) - Vista (Jun 2008)	MONA2-5	Jun 08	ThinkCentre A57 photography	TUNS1-P	Mar 08
ThinkCentre M57e Desktop (9481) - Vista (Oct 08)	MONA3-2	Oct 08	ThinkCentre A57 Small (9704) - TopSeller	TUNS1-1	Mar 08
ThinkCentre M57e Desktop (9438) - ES 4.0	MONA2-6	Aug 08	ThinkCentre A57 Small (9704) - TopSeller (Oct 08)	TUNS3-1	Oct 08
ThinkCentre M57e Desktop (6177) - ES 4.0 (GMP)	MONA2-7	Jun 08	ThinkCentre A57 Small (9704) - TopSeller (Vista)	TUNS1-2	Apr 08
ThinkCentre M57e Desktop (7065) - GMP	MONA1-12	Mar 08	ThinkCentre A57 Tower (9702) - TopSeller	TUNS1-3	Apr 08
ThinkCentre M57e Tower (6179) - TopSeller	MONA2-11	Aug 08	ThinkCentre A57 Tower (9702) - TopSeller (Oct 08)	TUNS3-2	Oct 08
ThinkCentre M57e Tower (6179) - TopSeller (Oct 08)	MONA3-5	Oct 08	ThinkCentre A57 Tower (9702) - TopSeller (Vista)	TUNS1-4	May 08
ThinkCentre M57e Tower (9439)	MONA1-6	Mar 08	ThinkCentre A57 Tower (9702) - TopS (Vista) - Dec	TUNS2-1	Dec 08
ThinkCentre M57e Tower (9439) - August 2008	MONA2-14	Aug 08	ThinkCentre A57 Tower (9851) - TopSeller	TUNS1-5	Apr 08
ThinkCentre M57e Tower (9439) - Vista	MONA1-3	Feb 08	ThinkCentre A57 Tower (9851) - TopSeller (Vista)	TUNS1-6	May 08
ThinkCentre M57e Tower (9439) - Vista (Mar 2008)	MONA1-10	Aug 08	<i>ThinkCentre A57 Accessories</i>	O-A57	Nov 08
ThinkCentre M57e Tower (9439) - Vista (June 2008)	MONA2-8	Jun 08	ThinkCentre A62 photography	ATHN1-P	Aug 08
ThinkCentre M57e Tower (9439) - Vista (Oct 2008)	MONA3-3	Oct 08	ThinkCentre A62 Desktop (9486)	ATHN1-7	Sep 08
ThinkCentre M57e Tower (9356) - ENERGY STAR 4.0	MONA1-9	Mar 08	ThinkCentre A62 Desktop (9486) - Vista	ATHN1-1	Sep 08
ThinkCentre M57e Tower (9356) - ES 4.0 (June 2008)	MONA2-9	Aug 08	ThinkCentre A62 Desktop (7057) - ENERGY STAR	ATHN1-2	Dec 08
ThinkCentre M57e Tower (6176) - ES 4.0 (GMP)	MONA2-10	Jun 08	ThinkCentre A62 Desktop (3658) - ES 4.0 (GMP)	ATHN2-1	Dec 08
ThinkCentre M57e Tower (7064) - GMP	MONA1-13	Mar 08	ThinkCentre A62 Desktop (7062) - GMP	ATHN1-3	Aug 08
ThinkCentre M57e Accessories	O-M57E	Nov 08	ThinkCentre A62 Tower (9705) - TopSeller	ATHN1-10	Dec 08
ThinkCentre M57 and M57p photography	BLLF1-P	Feb 08	ThinkCentre A62 Tower (9705) - TopSeller (Dec 08)	ATHN2-3	Jan 09
ThinkCentre M57 Eco Ultra Small (6395)	BLLF1-1	May 08	ThinkCentre A62 Tower (9935) - TopSeller	ATHN1-9	Sep 08
ThinkCentre M57 Eco Ultra Small (6395) - Aug 2008	BLLF1-4	Sep 08	ThinkCentre A62 Tower (9485)	ATHN1-8	Sep 08
ThinkCentre M57p Eco Ultra Small (6395)	BLLF1-2	Feb 08	ThinkCentre A62 Tower (9485) - Vista	ATHN1-4	Sep 08
ThinkCentre M57p Eco Ultra Small (6395) - Aug 2008	BLLF1-5	Sep 08	ThinkCentre A62 Tower (9625) - ENERGY STAR 4.0	ATHN1-5	Dec 08
ThinkCentre M57p Eco Ultra Small (6397) - GMP	BLLF1-3	Feb 08	ThinkCentre A62 Tower (3656) - ES 4.0 (GMP)	ATHN2-2	Dec 08
ThinkCentre M57 Ultra Small (6071)	APOL1-1	Oct 07	ThinkCentre A62 Tower (7061) - GMP	ATHN1-6	Aug 08
ThinkCentre M57 Ultra Small (6071) - January 2008	APOL2-1	Jan 08	<i>ThinkCentre A62 Accessories</i>	O-A62	Nov 08
ThinkCentre M57 Ultra Small (6071) - August 2008	APOL2-11	Sep 08	<i>ThinkCentre - ThinkPlus Services</i>	S-TC	Dec 08
ThinkCentre M57 Small (9970) - TopSeller	APOL2-7	Sep 08			
ThinkCentre M57 Small (6072)	APOL1-2	Dec 07			
ThinkCentre M57 Small (6072) - January 2008	APOL2-2	Jan 08			
ThinkCentre M57 Small (6072) - August 2008	APOL2-12	Sep 08			
ThinkCentre M57 Small (6072) - Vista (August 2008)	APOL2-14	Sep 08			
ThinkCentre M57 Small (9181) - ENERGY STAR 4.0	APOL1-3	Dec 07			
ThinkCentre M57 Tower (9978) - TopSeller	APOL2-8	Jun 08			
ThinkCentre M57 Tower (6075)	APOL1-4	Oct 07			
ThinkCentre M57 Tower (6075) - December 2007	APOL1-11	Dec 07			
ThinkCentre M57 Tower (6075) - January 2008	APOL2-3	Jan 08			
ThinkCentre M57 Tower (6075) - August 2008	APOL2-13	Sep 08			
ThinkCentre M57 Tower (9174) - ENERGY STAR 4.0	APOL1-5	Dec 07			



Personal Systems Reference Lenovo® ThinkPad® Notebooks

January 2009 - Version 350



Visit www.lenovo.com/psref for the latest version



128GB Solid State Drive SATA 3.0Gb/s 1.8" (with 2.5" cover)
43N3406



160GB Disk 9.5mm SATA 1.5Gb/s (7200 rpm)
41N5737



T/R 14W High Capacity Battery 9-cell
43R2499

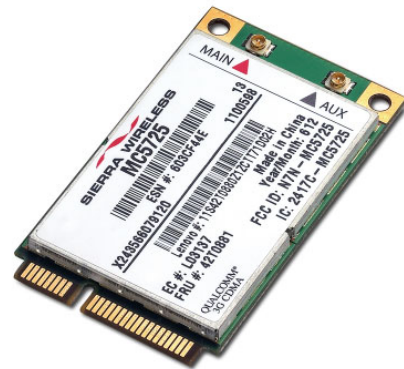

Verizon WWAN EV-DO Rev. A Mini PCIe
43R1818



USB 2.0 Security Memory Key 4GB
41U5120



Laser Tilt Wheel Travel Mouse (Bluetooth)
41U5008



USB 2.0 Lenovo Webcam
40Y8519



USB 2.0 Lenovo Enhanced Port Replicator
43R8770

ThinkPad® R61e 15W (GMA Graphics) - 1-year

Personal Systems Reference (PSREF)

Type-model	Processor	GHz	Memory	Wide-screen display	Graphics controller	Disk SATA GB ⁸	Disk rpm	EIDE optical	Mini PCIe 802.11 wireless	Finger print reader	Blue-tooth	Battery cells	Preload	Workhorse (W) Global (G)	Avail date
7649-22U	T7300	2.00	1GB	15.4" WXGA	GMA	80GB	5400	Combo	* Intel 11a/b/g ³²	None	None	6	Business 32	G	Jul 07

- This model has a 1-year limited warranty¹²

Positioning Processor	<i>Everyday computing; two spindles</i> Intel® Core™ 2 Duo processor T7300 with dual-core, Intel 64 Technology, Enhanced Intel SpeedStep® technology ¹ , Intel Dynamic Acceleration, Execute Disable Bit, Virtualization Technology, 800MHz system bus, and 4MB shared L2 cache										Preloaded operating system²⁰ - Microsoft® Windows® Vista™ Business Edition (32-bit) ⇨ Vista Premium logo				
Memory	512MB or 1GB std / 4GB max ⁷ / PC2-5300 667MHz DDR2, non-parity, dual-channel capable, two 200-pin SO-DIMM sockets; <i>Italics:</i> standard memory in both sockets; no sockets available										Preloaded applications¹⁴ <ul style="list-style-type: none"> • Rescue and Recovery™ • Access Connections™ • Client Security Solution™ • ThinkVantage Productivity Center • ThinkVantage System Update • System Migration Assistant • Norton Internet Security (90 days of virus definitions) • Diskeeper™ Home • PC-Doctor™ (diagnostics) • ThinkPad Utilities (Power Manager and Presentation Director) • Adobe® Reader • Windows Live™ Toolbar • Windows Live Search • Picasa from Google • Microsoft Office 2007 Trial (60-day) • Sonic RecordNow and Drive Letter Access (combo) • Corel® WinDVD® (combo) 				
Diskette drive	None (use optional USB-based diskette drive)														
EIDE Combo	DVD-ROM/CD-RW, 24X/24X/24X/8X ²¹ , fixed, not removable, 12.7mm high														
Ultrabay Enhanced	None (no support for removable Ultrabay™ options)														
Serial ATA disk	80GB⁸ (5400 rpm) / SATA 1.5Gb/s, 9.5mm high, removable, upgradable, 9.5mm high bay, supports 2nd disk, ThinkPad Shock Mounted Hard Drive, Active Protection System™														
Widescreen display	15.4" (391mm) WXGA (1280x800) color , anti-glare, 200 nits, 16:10 aspect ratio, 300:1 contrast ratio										Supports ThinkVantage® technologies 65-watt (GMA graphics) ThinkPad Roll Cage (one-piece magnesium frame) ENERGY STAR® 4.0-compliant RoHS-compliant International Warranty Service ¹⁷ 24 hour x 7 day ¹⁸ toll-free support during the warranty period ¹² via 800-426-7378 ThinkPlus™.22 1-year LOR ²⁴ 9x5 NBD 41C9166 ThinkPlus 2-year LOR 9x5 NBD 41C9167 ThinkPlus 3-year LOR 9x5 NBD 41C9168 ThinkPlus 4-year LOR 9x5 NBD 41C9171 ThinkPlus 5-year LOR 9x5 NBD 41C9173 ThinkPlus 2-year P&L P/U Depot 41C9169 ThinkPlus 3-year P&L P/U Depot 41C9170 ThinkPlus 4-year P&L P/U Depot 41C9172 ThinkPlus 5-year P&L P/U Depot 41C9174 Post-warranty annual maintenance agreements at lenovo.com/thinkplus/warranty				
Camera	None														
Graphics	Intel Graphics Media Accelerator X3100 (GMA X3100) , integrated in GM965, no DVI pass-through (no port replicator or docking station support)														
Keyboard	89-key, ThinkVantage button, spill-resistant, multimedia Fn keys, Windows/Apl keys														
TrackPoint®	TrackPoint® pointing device, "Press-to-Select," Internet Scroll Bar ¹³ (no touch pad)														
ThinkLight™	Illuminates the keyboard to improve visibility in low-light conditions														
Dimensions ³	<i>6-cell 15.4W"</i> (WxDxH): 14.1" x 10.2" x 1.39–1.52"; 358.5 x 260.0mm x 35.3–38.5mm														
Weight ²	<i>6-cell:</i> starting at 6.4 lb (2.9kg); <i>9-cell:</i> starting at 6.7 lb (3.1kg)														
Case material	Black color, Polycarbonate/Acrylonitrile-Butadiene-Styrene (PC/ABS) plastic														
Battery - type	Lithium Ion 6-cell														
Battery - life ¹⁰	<i>6-cell Celeron:</i> up to 2.1 hr; <i>6-cell Core 2 Duo:</i> 5.0 hr; <i>9-cell Core 2 Duo:</i> up to 7.0 hr														
Chipset	Mobile Intel GM965 Express Chipset (Graphics Memory Controller Hub); ICH8M I/O Controller Hub (SATA 3.0Gb/s, ATA-100 EIDE, PCI Express® x1, PCI bus, USB, LPC bus, [Bluetooth], / PCI bus (Ricoh® R5C804 Cardbus) /														
PC Card Std slot	One Type I or Type II slot, CardBus 32-bit														
ExpressCard slot	None														
Smart Card Read	None														
Multicard Reader	None														
Ports	Three USB 2.0, DB-15 (external VGA monitor), RJ-11 (modem), RJ-45 (ethernet)														
Wireless antenna	UltraConnect™ II antenna / on-off switch for all wireless radios														
Mini PCI Express	One Mini PCI Express slot / not customer upgradable														
Intel 11a/b/g ³²	11a/b/g wireless ⁴ , Mini PCIe adapter, Intel PRO/Wireless 3945ABG														
WWAN	None														
Modem	56K V.92 ⁶ modem, on systemboard, Conexant® CX20548														
Bluetooth™	None														
Ethernet	Gigabit ethernet, Broadcom® BCM5787M (MAC/PHY), PCIe x1, PXE														
Intel AMT	None														
Audio support	High Definition (HD) Audio, CX20549 codec / stereo speakers, 1 watt / volume up, down, mute buttons / microphone input jack, headphone jack														
Security	Power-on password, hard disk password, supervisor password, security keyhole														
Security chip	None														
Fingerprint reader	None														
Limited warranty ¹²	1-year - EasyServ™.19 depot repair service / service upgrades ²² available														
1GB PC2-5300 DDR2 SODIMM	40Y7734	T/R/W/SL Series Li-Ion Battery 6-cell		40Y6799											
2GB PC2-5300 DDR2 SODIMM	40Y7735	T/R/W/SL Series Li-Ion Battery 9-cell		40Y6797											
160GB Disk 9.5mm SATA 1.5Gb/s (7200)	41N5737	ThinkPad 90W AC Adapter		40Y7659											
200GB Disk FDE SATA 1.5Gb/s (7200 rpm)	41N5738	90W Slim AC/DC Combo Adapter		41N8460											
320GB Disk SATA 1.5Gb/s (5400 rpm)	43N3403	ThinkPad Business Topload Case		43R2476											
USB 2.0 Lenovo Multimedia Headset	40Y8518	ThinkPad Business Backpack		43R2482											
USB 2.0 Security Memory Key 4GB	41U5120	ThinkVision® L1940p Wide 19" Monitor		4424HB6											
USB 2.0 Super Multi-Burner Drive	41N5565	ThinkVision L2240p Wide 22" Monitor		4422HB6											
USB 2.0 Lenovo Enhanced Port Replicator	43R8770	ThinkVision L2440p Wide 24" Monitor		4420HB2											
Other accessories on O-R61E sheet	Other accessories at lenovo.com/accessories														

See footnotes for important warranty information
 US model announced July 10, 2007

* Intel Centrino® processor technology

© Lenovo
 (KON11-2) July 2007

Partial list of accessories supported on:**• ThinkPad R61e 15W originally announced on July 10, 2007****Memory**

512MB PC2-5300 DDR2 SODIMM	40Y7733	ann 01/05/06
1GB PC2-5300 DDR2 SODIMM (TopSeller)	43R1999	ann 03/25/08
1GB PC2-5300 DDR2 SODIMM	40Y7734	ann 01/05/06
2GB PC2-5300 DDR2 SODIMM (TopSeller)	43R2000	ann 03/25/08
2GB PC2-5300 DDR2 SODIMM	40Y7735	ann 11/28/06

Ultrabay Slim 9.5mm

None (no removable bay options)

Ultrabay Enhanced 12.7mm

None (no removable bay options)

Storage and removable storage

160GB Disk 9.5mm SATA 1.5Gb/s (5400 rpm)	41N5692	ann 03/20/07
160GB Disk 9.5mm SATA 1.5Gb/s (7200 rpm)	41N5737	ann 10/16/07
250GB Disk 9.5mm SATA 1.5Gb/s (5400 rpm)	43R8152	ann 01/15/08
320GB Disk SATA 1.5Gb/s (5400 rpm)	43N3403	ann 08/05/08
USB 2.0 Essential Memory Key 1GB	41U4940	ann 01/23/07
USB 2.0 Essential Memory Key 2GB	41U4944	ann 01/23/07
USB 2.0 Essential Memory Key 4GB	45J7904	ann 06/24/08
USB 2.0 Essential Memory Key 8GB	45J7905	ann 07/15/08
USB 2.0 Essential Memory Key 32GB	45K1258	ann 10/28/08
USB 2.0 Security Memory Key 1GB	41U5118	ann 07/17/07
USB 2.0 Security Memory Key 2GB	41U5119	ann 07/17/07
USB 2.0 Security Memory Key 4GB	41U5120	ann 07/17/07
USB 2.0 Ultra Secure Memory Key 1GB	45J5915	ann 08/26/08
USB 2.0 Ultra Secure Memory Key 2GB	45J5916	ann 08/26/08
USB 2.0 Ultra Secure Memory Key 4GB	45J5917	ann 08/26/08
USB 2.0 Ultra Secure Memory Key 8GB	45J5918	ann 08/26/08
USB Portable Diskette Drive	05K9276	ann 06/05/00
USB 2.0 CD-RW/DVD-ROM Combo II Drive	40Y8637	ann 01/05/06
USB 2.0 Portable 160GB Hard Disk	43R1784	ann 09/23/08
USB 2.0 Portable Secure 160GB Hard Disk	43R2018	ann 11/18/08
USB 2.0 Portable Secure 320GB Hard Disk	43R2019	ann 11/18/08
USB 2.0 Super Multi-Burner Drive	41N5565	ann 01/23/07

Wireless LAN (Mini PCI Express)

No Mini PCI Express upgrade supported (use PC Card)

ThinkPad Expansion

USB 2.0 Lenovo Enhanced Port Replicator	43R8770	ann 02/26/08
ThinkPad Adjustable Notebook Stand	40Y7676	ann 09/20/05

Keyboard

TrackPoint Cap Collection	73P2698	ann 12/16/03
USB Numeric Keypad	33L3225	ann 05/01/00
Preferred Pro USB Keyboard	73P5220	ann 06/21/05
Enhanced Performance USB Keyboard	73P2620	ann 03/23/04
Wireless Kybd & Opt Wheel Mouse (via USB)	73P4067	ann 12/07/04
USB Keyboard with UltraNav	31P8950	ann 01/28/03
USB Travel Keyboard with UltraNav	31P9490	ann 04/27/04
Lenovo USB Fingerprint Keyboard	73P4730	ann 02/22/05

Mouse

Optical Wheel Mouse (USB)	06P4069	ann 05/21/03
Optical ScrollPoint® Mouse (USB, PS/2)	31P7405	ann 08/27/02
Optical Wheel Travel Mouse (USB, PS/2)	31P7410	ann 06/04/02
Laser Tilt Wheel Mouse (USB, PS/2)	41U3074	ann 01/23/07
Lenovo Wireless Laser Mouse (blk, via USB)	45K1696	ann 11/25/08
Lenovo Wireless Laser Mouse (red, via USB)	51J0198	ann 11/25/08
Laser Tilt Wheel Travel Mouse (Bluetooth)	41U5008	ann 01/22/08
Wireless Kybd & Opt Wheel Mouse (via USB)	73P4067	ann 12/07/04

Security

Kensington® Cable Lock from Lenovo	73P2582	ann 12/29/03
Kensington Twin Head Cable Lock	45K1620	ann 09/30/08
USB Gemplus GemPC Smart Card Reader	41N3040	ann 02/21/06
PC Card Gemplus Smart Card Reader	41N3004	ann 12/13/05

Multimedia

USB 2.0 Lenovo Multimedia Headset	40Y8518	ann 06/27/06
USB 2.0 Lenovo Webcam	40Y8519	ann 08/29/06

Batteries

T/R/W/SL Series Li-Ion Battery 6-cell	40Y6799	ann 01/05/06
T/R/W/SL Series Li-Ion Battery 9-cell	40Y6797	ann 09/20/05
ThinkPad External Battery Charger ⁴⁴	40Y7625	ann 09/20/05

⁴⁴ Requires the *ThinkPad 90W AC Adapter*

40Y7659 (adapter provided with some systems).

ThinkPad 65W AC Adapter ⁴⁵	40Y7696	ann 01/05/06
---------------------------------------	---------	--------------

⁴⁵ Only compatible with the 945GM and GM965 chipset models.

ThinkPad 90W AC Adapter	40Y7659	ann 09/20/05
ThinkPad 90W Slim AC/DC Combo Adapter	41N8460	ann 11/27/07

Charging tips for 90W Slim AC/DC Combo Adapter 41N8460

• Dual (ThinkPad+Phone) Charging Y-Cable	41R4345	ann 12/18/07
• Palm device charge tip (L7)	41R4315	ann 12/18/07
• BlackBerry charge tip (L8a)	41R4478	ann 12/18/07
• iPod and iPhone charge tip (L10a)	41R4481	ann 12/18/07

Carrying Cases**Up to 15.4" widescreen models:**

Lenovo Carrying Case - Messenger Max	41U5253	ann 05/01/07
Lenovo Carr Case - Performance BackPack	41U5254	ann 05/01/07
Lenovo Standard Case	45K1697	ann 11/25/08
Lenovo Standard Backpack	45K1698	ann 11/25/08
ThinkPad Business Topload Case	43R2476	ann 05/13/08
ThinkPad Business Backpack	43R2482	ann 05/13/08
ThinkPad Deluxe Expander Case	43R2478	ann 05/13/08
ThinkPad Executive Leather Case	43R2480	ann 05/13/08

Up to 17.0" widescreen models:

ThinkPad 17W Business Topload Case	43R9117	ann 08/12/08
------------------------------------	---------	--------------

Monitors

ThinkVision® L174 17" Monitor	9227AE1	ann 04/15/08
ThinkVision L1700p 17" Monitor	9417HE2	ann 09/17/08
ThinkVision L1900p 19" Monitor	4431HE1	ann 11/11/08
ThinkVision L1940p Wide 19" Monitor	4424HB6	ann 09/17/08
ThinkVision L200p Wide 20.1" Monitor	4438HB6	ann 04/15/08
ThinkVision L2240p Wide 22" Monitor	4422HB6	ann 09/17/08
ThinkVision L2440p Wide 24" Monitor	4420HB2	ann 09/17/08
ThinkVision L2440x Wide 24" Monitor	4421HB2	ann 09/17/08

Monitor Accessories⁴⁶

ThinkVision USB Soundbar	40Y7616	ann 08/23/05
ThinkVision Soundbar	45K1263	ann 09/16/08
Kensington Cable Lock from Lenovo	73P2582	ann 12/29/03
Kensington Twin Head Cable Lock	45K1620	ann 09/30/08
ThinkPad Convertible Monitor Stand	40Y7620	ann 01/05/06
Radial Arm	19K4464	ann 05/05/00

⁴⁶ Compatible on selected Lenovo and ThinkVision monitors.More information at www.lenovo.com/support/monitoraccessoriesOther accessories at www.lenovo.com/accessoriesAccessories Guide pdf at www.lenovo.com/accessoriesguide

ThinkPad® R61 14W 7733 (GMA) - Linux

Personal Systems Reference (PSREF)

Proc- Type-model	essor GHz	Memory	Wide- screen display	Graphics controller	Disk SATA GB ³ rpm	EIDE optical	Mini PCIe 802.11 wireless	Mini PCIe WWAN or Turbo	Card slot	Blue- tooth	Finger print reader	Bat- tery Linux preload	Workhorse (W) Global (G) Entry	Avail date
7733-3BU	T7500	2.20	1GB	14.1" WXGA	GMA	80G 5400	Combo	*Intel 11a/b/g ³²	None	/54	None	None	6 SLED10	W G Jan 08
Positioning Processor	<i>Everyday computing; two spindles</i> Intel® Core™ 2 Duo processor T7500 with dual-core , Intel 64 Technology, Enhanced Intel SpeedStep technology ¹ , Intel Dynamic Acceleration, Execute Disable Bit, Virtualization Technology, 800MHz system bus, and 4MB shared L2 cache											Preloaded operating system²⁰ - SUSE® Linux™ Enterprise Desktop10 Service Pack 1		
Memory	1GB std / 4GB max ⁷ / PC2-5300 667MHz DDR2, non-parity, dual-channel capable, two 200-pin SO-DIMM sockets; <i>Non-italics:</i> standard memory in 1 socket; 1 socket available											Preloaded applications¹⁴ • None		
Diskette drive	None (use optional USB-based diskette drive)											Supported devices (only some listed) • HD Audio • Intel 3945ABG wireless • Intel Graphics Media Accelerator X3100 (GMA X3100) • NVIDIA Quadro NVS 140M • Fingerprint reader • Bluetooth • Function keys • ThinkPad Advanced Dock		
EIDE Combo	DVD-ROM/CD-RW (73P3288), 24X/24X/24X/8X ²¹ , removable Ultrabay™ Enhanced													
Ultrabay Enhanced	One bay for removable devices, Ultrabay Slim-compatible, 12.7mm high													
Serial ATA disk	80GB³ (5400 rpm) / SATA 1.5Gb/s, 9.5mm high, removable, upgradable, 9.5mm high bay, supports 2nd disk, ThinkPad Shock Mounted Hard Drive											Non-supported devices (only some listed) • Intel 4965AG, Intel 4965AGN, ThinkPad 11a/b/g, ThinkPad 11n wireless • WWAN • Active Protection System™ • ThinkVantage® button • Security chip • Intel Turbo Memory • Intel AMT technology • Integrated camera		
Widescreen display	14.1" (358.1mm) WXGA (1280x800) color , anti-glare, 185 nits, 16:10 aspect ratio, 300:1 contrast ratio													
Camera	None													
Graphics	Intel Graphics Media Accelerator X3100 (GMA X3100) , integrated in GM965													
Keyboard	89-key, ThinkVantage button, spill-resistant, multimedia Fn keys, Windows/Appl keys													
TrackPoint®	TrackPoint® pointing device, "Press-to-Select," Internet Scroll Bar ¹³ , magnifying glass													
Touch pad	UltraNav™ multi-pointing system, touch pad below keyboard, Tap Zones													
ThinkLight™	Illuminates the keyboard to improve visibility in low-light conditions													
Dimensions ³	<i>6-cell 14.1W" (WxDxH): 13.2" x 10.2" x 1.2-1.37"; 335mm x 261mm x 30.6-34.9mm</i>													
Weight ²	<i>6-cell: starting at 5.5 lb (2.5kg)</i>													
Case material	<i>Top: Super-Elastic PolyCarbonate (SEPC); Bottom: Carbon-Fiber Reinforced Plastic</i>													
Battery - type	Lithium Ion 6-cell , supports unique 2nd battery in Ultrabay Slim													
Battery - life ¹⁰	Not published													
Chipset	Mobile Intel GM965 Express Chipset (Graphics Memory Controller Hub); ICH8M-Enhanced I/O Controller Hub (SATA 3.0Gb/s, ATA-100 EIDE, PCI Express [®] x1, PCI bus, USB, LPC bus, [Bluetooth], [fingerprint]) / PCI bus (Ricoh® R5C847 Cardbus/1394/Multicard) / LPC bus (WPCN385 Super I/O, Atmel® 97SC3203 TPM)											Non-supported applications (only some listed) • ThinkPad Utilities • ThinkVantage technologies • Presentation Director • Encrypted DVD playback • Keyboard Customizer		
PC Card Std slot	One Type I or Type II slot, CardBus 32-bit													
ExpressCard slot	[54] One ExpressCard/34 or ExpressCard/54													
Smart Card Read	None													
Multicard Reader	None													
Ports	Three USB 2.0, DB-15 (external VGA monitor), RJ-11 (modem), RJ-45 (ethernet); IEEE 1394 FireWire 400 (4-pin connector; 1394a-2000 standard)													
Wireless antenna	UltraConnect™ II antenna / on-off switch for all wireless radios													
Mini PCI Express	Two Mini PCI Express slots / only 802.11 wireless is customer upgradable													
Intel 11a/b/g ³²	11a/b/g wireless ⁴ , Mini PCIe adapter, Intel PRO/Wireless 3945ABG													
WWAN	None													
Turbo Memory	None													
Modem	56K V.92 ⁶ modem in Communications Daughter Card socket													
Bluetooth™	None													
Ethernet	Gigabit ethernet, Intel 82566MM Nineveh (PHY), PCIe x1 (GLCI), PXE													
Intel AMT	None													
Audio support	High Definition (HD) Audio, AD1984HD codec / stereo speakers, 1 watt / volume up, down, mute buttons / internal microphone, microphone input jack, headphone jack													
Security	Power-on password, hard disk password, supervisor password, security keyhole													
Security chip	Trusted Platform Module , Atmel chip, TCG 1.2-compliant													
Fingerprint reader	None													
Limited warranty ¹²	3-years/1-yr battery - EasyServ™.19 depot repair service / service upgrades ²² available													
512MB PC2-5300 DDR2 SODIMM	40Y7733			T/R 14W Standard Battery 4-cell				41U3196						
1GB PC2-5300 DDR2 SODIMM	40Y7734			T/R 14W Enhanced Battery 6-cell				41U3198						
2GB PC2-5300 DDR2 SODIMM	40Y7735			T/R 14W High Capacity Batt 9-cell				43R2499						
ThinkPad DVD Ultrabay Slim Burner (flat)	41N5643			Advanced Ultrabay Battery II 3-cell				43R9250						
Serial Hard Drive Ultrabay Slim Adapter (flat)	40Y8725			ThinkPad External Battery Charger				40Y7625						
320GB Disk SATA 1.5Gb/s (5400 rpm)	43N3403			90W Slim AC/DC Combo Adapter				41N8460						
USB 2.0 Ultra Secure Memory Key 8GB	45J5918			ThinkPad Business Topload Case				43R2476						
ThinkPad Essential Port Replicator	250510W			ThinkPad Business Backpack				43R2482						
ThinkPad Advanced Mini Dock	250410U			ThinkVision® L2240p Wide 22" Monitor				4422HB6						
ThinkPad Advanced Dock	250310U			ThinkVision L2440p Wide 24" Monitor				4420HB2						
Check Linux compatibility for other accessories	Other accessories at lenovo.com/accessories													

See footnotes for important warranty information
US model announced January 15, 2008

* Intel Centrino® processor technology

© Lenovo
(LAG1-9) January 2008

Proc- Type-model essor	GHz	Memory	Wide- screen display	Graphics controller	Disk SATA GB ⁸ rpm	EIDE optical	Mini PCIe 802.11 wireless	Mini PCIe Intel Turbo	Card slot	Bat- tery tooth cells	Vista preload	Whorse (W) Limited Gbl (G) Avail warranty ¹² Entry date
7733-2UU 540	1.86	1GB	14.1" WXGA	GMA 80G	5400 Combo		Intel 11a/b/g ³²	None	/54	Blue 4	Business32	3-yr W G Nov07
7738-1GU T7300	2.00	1GB	14.1" WXGA+	GMA 120G	5400 DVD±RW		*Intel 11a/b/g	None	/54	Blue 4	Business32	1-yr W G Jun 07
7738-11U T7300	2.00	1GB	14.1" WXGA+	GMA 120G	5400 DVD±RW		*Intel 11a/b/g	None	/54	Blue 4	Business64	1-yr W G May07
7733-1GU T7300	2.00	1GB	14.1" WXGA	GMA 80G	5400 Combo		*Intel 11a/b/g	None	Smart	Blue 4	Business32	3-yr W G Jun 07
7733-11U T7300	2.00	1GB	14.1" WXGA	GMA 80G	5400 Combo		*Intel 11a/b/g	None	Smart	Blue 4	Business64	3-yr W G May07
7733-01U T7300	2.00	1GB	14.1" WXGA	GMA 100G	7200 Combo		*Intel 11a/b/g	None	/54	6	XP Pro	3-yr Aug07
7733-1EU T7300	2.00	1GB	14.1" WXGA	GMA 80G	5400 Combo		*Intel 11a/b/g	None	Smart	Blue 4	XP Pro	3-yr G Sep07

Italic MTM: not a base model for building a custom model

Positioning Processor	<p><i>Everyday computing; two spindles</i></p> <p>Intel® Celeron® Processor 540 with single-core, Intel 64 Technology, Execute Disable Bit, 533MHz system bus, and 1MB L2 cache or Intel® Core™ 2 Duo processor T7300 with dual-core, Intel 64 Technology, Enhanced Intel SpeedStep® technology¹, Intel Dynamic Acceleration, Execute Disable Bit, Virtualization Technology, 800MHz system bus, and 4MB shared L2 cache</p>	<p>Preloaded operating system²⁰</p> <ul style="list-style-type: none"> - Some: Microsoft® Windows® XP Professional - Some: Microsoft Windows Vista® Business Edition (32-bit) - Some: Microsoft Windows Vista Business Edition (64-bit) <p>◇ Vista models: Vista Basic logo</p>
Memory	<p>1GB std / 4GB max⁷ / PC2-5300 667MHz DDR2, non-parity, dual-channel capable, two 200-pin SO-DIMM sockets;</p> <p><i>Non-italics:</i> standard memory in 1 socket; 1 socket available</p>	<p>Preloaded applications¹⁴ (all OSes)</p> <ul style="list-style-type: none"> • Rescue and Recovery™ • Access Connections™ • Client Security Solution™ • ThinkVantage Productivity Center • ThinkVantage System Update • System Migration Assistant • Norton Internet Security (90 days of virus definitions) • Diskeeper® Home • PC-Doctor™ (diagnostics) • ThinkPad Utilities (Power Manager and Presentation Director) • Adobe® Reader • Windows Live™ Toolbar • Windows Live Search • Picasa from Google • Fingerprint Software (fingerprint models) • Multimedia Center for Think Offerings (XP) • Microsoft Office 2007 Trial (60-day) • Sonic RecordNow and Drive Letter Access (combo, DVD±RW) • Corel® WinDVD® (combo, DVD±RW)
Diskette drive EIDE Combo EIDE DVD±RW Ultrabay Enhanced Serial ATA disk	<p>None (use optional USB-based diskette drive)</p> <p><i>Some:</i> DVD-ROM/CD-RW (73P3288), 24X/24X/24X/8X²¹, removable Ultrabay™ Enh</p> <p><i>Some:</i> DVD burner, Super Multi-Burner (40Y8624) dual-layer, removable Ultrabay Enh</p> <p>One bay for removable devices, Ultrabay Slim-compatible, 12.7mm high</p> <p>80GB⁸ (5400 rpm), 100GB (7200 rpm), or 120GB (5400 rpm) / SATA 1.5Gb/s, 9.5mm high, removable, upgradable, 9.5mm high bay, supports 2nd disk, ThinkPad Shock Mounted Hard Drive, Active Protection System™</p>	
Widescreen display Camera	<p><i>Some:</i> 14.1" (358.1mm) WXGA (1280x800) color, anti-glare, 185 nits, 16:10, 300:1</p> <p><i>Some:</i> 14.1" (358.1mm) WXGA+ (1440x900) color, anti-glare, 200 nits, 16:10, 300:1</p> <p>None</p>	
Graphics	<p>Intel Graphics Media Accelerator X3100 (GMA X3100), integrated in GM965, DVI pass-through support to optional Advanced Mini Dock or Advanced Dock</p>	
Keyboard TrackPoint® Touch pad ThinkLight™	<p>89-key, ThinkVantage button, spill-resistant, multimedia Fn keys, Windows/Apl keys</p> <p>TrackPoint® pointing device, "Press-to-Select," Internet Scroll Bar¹³, magnifying glass</p> <p>UltraNav™ multi-pointing system, touch pad below keyboard, Tap Zones</p> <p>Illuminates the keyboard to improve visibility in low-light conditions</p>	
Dimensions ³ Weight ² Case material Battery - type Battery - life ¹⁰	<p>4-cell 14.1W" (WxDxH): 13.2" x 9.3" x 1.2-1.37"; 335mm x 237mm x 30.6-34.9mm</p> <p>4-cell: starting at 5.2 lb (2.4kg); optional 6-cell: starting at 5.5 lb (2.5kg)</p> <p><i>Top:</i> Super-Elastic PolyCarbonate (SEPC); <i>Bottom:</i> Carbon-Fiber Reinforced Plastic</p> <p>Lithium Ion 4-cell or 6-cell, supports unique 2nd battery in Ultrabay Slim</p> <p>4-cell: up to 3.6 hr; 6-cell: up to 5.7 hr; 6-cell plus Ultrabay battery: up to 7.2 hr</p>	
Chipset	<p>Mobile Intel GM965 Express Chipset (Graphics Memory Controller Hub); ICH8M-Enhanced I/O Controller Hub (SATA 3.0Gb/s, ATA-100 EIDE, PCI Express® x1, PCI bus, USB, LPC bus, [Bluetooth], [fingerprint]) / PCI bus (Ricoh® R5C847 Cardbus/1394/Multicard) / LPC bus (WPCN385 Super I/O, Atmel® 97SC3203 TPM)</p>	
PC Card Std slot ExpressCard slot Smart Card Read Multicard Reader Ports	<p>One Type I or Type II slot, CardBus 32-bit</p> <p><i>Some:</i> [/54] One ExpressCard/34 or ExpressCard/54</p> <p><i>Some:</i> Smart Card Reader</p> <p>None</p> <p>Three USB 2.0, DB-15 (external VGA monitor), RJ-11 (modem), RJ-45 (ethernet); <i>Model 1EU:</i> IEEE 1394 FireWire 400 (4-pin connector; 1394a-2000 standard)</p>	
Wireless antenna Mini PCI Express Intel 11a/b/g ³² WWAN Turbo Memory Modem Bluetooth™ Ethernet Intel AMT Audio support	<p>UltraConnect™ II antenna / on-off switch for all wireless radios</p> <p>Two Mini PCI Express slots / only 802.11 wireless is customer upgradable</p> <p>11a/b/g wireless⁴, Mini PCIe adapter, Intel PRO/Wireless 3945ABG</p> <p>None</p> <p>None</p> <p>56K V.92⁶ modem in Communications Daughter Card socket</p> <p><i>Some:</i> Bluetooth 2.0 wireless, USB 2.0 interface via ICH8M, LED indicator</p> <p>Gigabit ethernet, Intel 82566MM Nineveh (PHY), PCIe x1 (GLCI), PXE</p> <p>None</p> <p>High Definition (HD) Audio, AD1984HD codec / stereo speakers, 1 watt / volume up, down, mute buttons / internal microphone, microphone input jack, headphone jack</p>	
Security Security chip Fingerprint reader	<p>Power-on password, hard disk password, supervisor password, security keyhole</p> <p>Trusted Platform Module, Atmel chip, TCG 1.2-compliant</p> <p>Fingerprint reader on palm rest, swipe sensor, supports the security chip</p>	<p>Supports ThinkVantage® technologies</p>
Limited warranty ¹²	<p>7738: 1-year - EasyServ™¹⁹ depot repair service / service upgrades²² available</p> <p>7733: 3-years/1-yr battery - EasyServ depot repair service / srv upgrades²² available</p>	<p>65-watt (GMA graphics) AC adapter</p> <p>ThinkPad Roll Cage and Top Cover</p> <p>Roll Cage (one-piece magnesium)</p> <p>ENERGY STAR® 4.0-compliant</p> <p>RoHS-compliant</p> <p>International Warranty Service¹⁷</p> <p>24 hour x 7 day¹⁸ toll-free support during the warranty period¹² via 800-426-7378</p>
1GB PC2-5300 DDR2 SODIMM 2GB PC2-5300 DDR2 SODIMM ThinkPad DVD Ultrabay Slim Burner (flat) Serial Hard Drive Ultrabay Slim Adapter (flat) 200GB Disk FDE SATA 1.5Gb/s (7200 rpm) USB 2.0 Security Memory Key 4GB USB 2.0 Portable Secure 320GB Hard Disk ThinkPad Advanced Mini Dock Other accessories on O-R61-14W sheet	<p>40Y7734</p> <p>40Y7735</p> <p>41N5643</p> <p>40Y8725</p> <p>41N5738</p> <p>41U5120</p> <p>43R2019</p> <p>250410U</p>	<p>T/R 14W Standard Battery 4-cell 41U3196</p> <p>T/R 14W Enhanced Battery 6-cell 41U3198</p> <p>T/R 14W High Capacity Batt 9-cell 43R2499</p> <p>Advanced Ultrabay Battery II 3-cell 43R9250</p> <p>90W Slim AC/DC Combo Adapter 41N8460</p> <p>ThinkPad Business Topload Case 43R2476</p> <p>ThinkVision® L2240p Wide 22" Monitor 4422HB6</p> <p>ThinkVision L2440x Wide 24" Monitor 4421HB2</p> <p>Other accessories at lenovo.com/accessories</p>

See footnotes for important warranty information

* Intel Centrino® processor technology

© Lenovo

US models announced May 9, June 19, August 21, Sept 4, or Nov 20, 2007

(LAG1-3) December 2007

⚠ US models withdrawn effective May 2008

Type-model	Proc- essor	GHz	Memory	Wide- screen display	Graphics controller	Disk SATA GB ⁸	rpm	EIDE optical	Mini PCIe 802.11 wireless	Mini PCIe Intel Turbo	Card slot	Blue- tooth	Bat- tery cells	Preload	Whorse (W) Limited warranty ¹²	Gbl (G) GMP (P)	Avail date
7735-2UU	540	1.86	1GB	14.1" WXGA	GMA	80G	5400	Combo	Intel 11a/b/g ³²	None	/54	Blue	4	Business32	3-yr	W G P	Nov 07
7735-1GU	T7300	2.00	1GB	14.1" WXGA	GMA	80G	5400	Combo	*Intel 11a/b/g	None	Smart	Blue	4	Business32	3-yr	W G P	Jun 07
7735-11U	T7300	2.00	1GB	14.1" WXGA	GMA	80G	5400	Combo	*Intel 11a/b/g	None	Smart	Blue	4	Business64	3-yr	W G P	May 07
≧ 7735-1EU	T7300	2.00	1GB	14.1" WXGA	GMA	80G	5400	Combo	*Intel 11a/b/g	None	Smart	Blue	4	XP Pro	3-yr	W G P	May 07

• These models are part of the Global Models Plus program with limited onsite service²⁴ 3-year limited warranty

Positioning Processor	<p><i>Everyday computing; two spindles</i> Intel® Celeron® Processor 540 with single-core, Intel 64 Technology, Execute Disable Bit, 533MHz system bus, and 1MB L2 cache or Intel Core™ 2 Duo processor T7300 with dual-core, Intel 64 Technology, Enhanced Intel SpeedStep® technology¹, Intel Dynamic Acceleration, Execute Disable Bit, Virtualization Technology, 800MHz system bus, and 4MB shared L2 cache</p>											<p>Preloaded operating system²⁰ - <i>Some:</i> Microsoft® Windows® XP Professional - <i>Some:</i> Microsoft Windows Vista® Business Edition (32-bit) - <i>Some:</i> Microsoft Windows Vista Business Edition (64-bit) ◇ <i>Vista models:</i> Vista Basic logo</p>					
Memory	<p>1GB std / 4GB max⁷ / PC2-5300 667MHz DDR2, non-parity, dual-channel capable, two 200-pin SO-DIMM sockets; <i>Non-italics:</i> standard memory in 1 socket; 1 socket available</p>											<p>Preloaded applications¹⁴ (all OSes) • Rescue and Recovery™ • Access Connections™ • Client Security Solution™ • ThinkVantage Productivity Center • ThinkVantage System Update • System Migration Assistant • Norton Internet Security (90 days of virus definitions) • Diskeeper® Home • PC-Doctor™ (diagnostics) • ThinkPad Utilities (Power Manager and Presentation Director) • Adobe® Reader • Windows Live™ Toolbar • Windows Live Search • Picasa from Google • Fingerprint Software (fingerprint models) • Multimedia Center for Think Offerings (XP) • Microsoft Office 2007 Trial (60-day) • Sonic RecordNow and Drive Letter Access (combo) • Corel® WinDVD® (combo)</p>					
Diskette drive	None (use optional USB-based diskette drive)																
EIDE Combo	DVD-ROM/CD-RW (73P3288), 24X/24X/24X/8X ²¹ , removable Ultrabay™ Enhanced																
Ultrabay Enhanced	One bay for removable devices, Ultrabay Slim-compatible, 12.7mm high																
Serial ATA disk	80GB⁸ (5400 rpm) / SATA 1.5Gb/s, 9.5mm high, removable, upgradable, 9.5mm high bay, supports 2nd disk, ThinkPad Shock Mounted Hard Drive, Active Protection System™																
Widescreen display	14.1" (358.1mm) WXGA (1280x800) color , anti-glare, 185 nits, 16:10 aspect ratio, 300:1 contrast ratio																
Camera	None																
Graphics	Intel Graphics Media Accelerator X3100 (GMA X3100) , integrated in GM965, DVI pass-through support to optional Advanced Mini Dock or Advanced Dock																
Keyboard	89-key, ThinkVantage button, spill-resistant, multimedia Fn keys, Windows/Appl keys																
TrackPoint®	TrackPoint® pointing device, "Press-to-Select," Internet Scroll Bar ¹³ , magnifying glass																
Touch pad	UltraNav™ multi-pointing system, touch pad below keyboard, Tap Zones																
ThinkLight™	Illuminates the keyboard to improve visibility in low-light conditions																
Dimensions ³	4-cell 14.1W" (WxDxH): 13.2" x 9.3" x 1.2–1.37"; 335mm x 237mm x 30.6–34.9mm																
Weight ²	4-cell: starting at 5.2 lb (2.4kg); optional 6-cell: starting at 5.5 lb (2.5kg)																
Case material	Top: Super-Elastic PolyCarbonate (SEPC); Bottom: Carbon-Fiber Reinforced Plastic																
Battery - type	Lithium Ion 4-cell , supports unique 2nd battery in Ultrabay Slim																
Battery - life ¹⁰	4-cell: up to 3.6 hr; 6-cell: up to 5.7 hr; 6-cell plus Ultrabay battery: up to 7.2 hr																
Chipset	Mobile Intel GM965 Express Chipset (Graphics Memory Controller Hub); ICH8M-Enhanced I/O Controller Hub (SATA 3.0Gb/s, ATA-100 EIDE, PCI Express® x1, PCI bus, USB, LPC bus, [Bluetooth], [fingerprint]) / PCI bus (Ricoch® R5C847 Cardbus/1394/Multicard) / LPC bus (WPCN385 Super I/O, Atmel® 97SC3203 TPM)																
PC Card Std slot	One Type I or Type II slot, CardBus 32-bit																
ExpressCard slot	<i>Some:</i> [/54] One ExpressCard/34 or ExpressCard/54																
Smart Card Read	<i>Some:</i> Smart Card Reader																
Multicard Reader	None																
Ports	Three USB 2.0, DB-15 (external VGA monitor), RJ-11 (modem), RJ-45 (ethernet); <i>Model 1EU:</i> IEEE 1394 FireWire 400 (4-pin connector; 1394a-2000 standard)																
Wireless antenna	UltraConnect™ II antenna / on-off switch for all wireless radios																
Mini PCI Express	Two Mini PCI Express slots / only 802.11 wireless is customer upgradable																
Intel 11a/b/g ³²	11a/b/g wireless ⁴ , Mini PCIe adapter, Intel PRO/Wireless 3945ABG																
WWAN	None																
Turbo Memory	None																
Modem	56K V.92 ⁶ modem in Communications Daughter Card socket																
Bluetooth™	Bluetooth 2.0 wireless, USB 2.0 interface via ICH8M, LED indicator																
Ethernet	Gigabit ethernet, Intel 82566MM Nineveh (PHY), PCIe x1 (GLCI), PXE																
Intel AMT	None																
Audio support	High Definition (HD) Audio, AD1984HD codec / stereo speakers, 1 watt / volume up, down, mute buttons / internal microphone, microphone input jack, headphone jack											Supports ThinkVantage® technologies					
Security	Power-on password, hard disk password, supervisor password, security keyhole											65-watt (GMA graphics) AC adapter					
Security chip	Trusted Platform Module , Atmel chip, TCG 1.2-compliant											ThinkPad Roll Cage and Top Cover					
Fingerprint reader	Fingerprint reader on palm rest , swipe sensor, supports the security chip											Roll Cage (one-piece magnesium)					
Limited warranty ¹²	3-years/1-year battery, limited onsite service²⁴ , 8 am - 5 pm, Mon - Fri coverage excluding holidays, next business day response time / service upgrades ²² available											ENERGY STAR® 4.0-compliant					
1GB PC2-5300 DDR2 SODIMM	40Y7734				T/R 14W Standard Battery 4-cell				41U3196								
2GB PC2-5300 DDR2 SODIMM	40Y7735				T/R 14W Enhanced Battery 6-cell				41U3198								
ThinkPad DVD Ultrabay Slim Burner (flat)	41N5643				T/R 14W High Capacity Batt 9-cell				43R2499								
Serial Hard Drive Ultrabay Slim Adapter (flat)	40Y8725				Advanced Ultrabay Battery II 3-cell				43R9250								
320GB Disk SATA 1.5Gb/s (5400 rpm)	43N3403				90W Slim AC/DC Combo Adapter				41N8460								
USB 2.0 Ultra Secure Memory Key 8GB	45J5918				ThinkPad Business Topload Case				43R2476								
USB 2.0 Portable Secure 320GB Hard Disk	43R2019				ThinkPad Business Backpack				43R2482								
USB 2.0 Lenovo Enhanced Port Replicator	43R8770				ThinkVision® L2240p Wide 22" Monitor				4422HB6								
ThinkPad Advanced Mini Dock	250410U				ThinkVision L2440x Wide 24" Monitor				4421HB2								
Other accessories on O-R61-14W sheet												Other accessories at lenovo.com/accessories					

See footnotes for important warranty information

* Intel Centrino® processor technology

© Lenovo

US models announced May 9, June 19, or November 20, 2007

(LAG1-11) February 2008

≧ US models withdrawn effective May 2008

ThinkPad® R61 14W (GMA Graphics) - Education (EasyServ)

Personal Systems Reference (PSREF)

Proc- Type-model	essor GHz	Memory	Wide- screen display	Graphics controller	Disk SATA GB ³	EIDE optical	Mini PCIe 802.11 wireless	Mini PCIe Intel Turbo	Finger print reader	Bat- tery cells	Vista pre- load	Educ pre- load	Workhorse (W) Limited warranty ¹²	(G) Avail date
7733-1BU	T7300	2.00 1GB	14.1" WXGA	GMA	120G 5400	DVD±RW	11a/b/g ³²	None	4-in-1	Fing	6	B32 HE	EasyServ W	May 07
7733-1CU	T7300	2.00 1GB	14.1" WXGA	GMA	80G 5400	Combo	11a/b/g	None	4-in-1	6	B32 K12	EasyServ W	May 07	

• **These models have an EasyServ™,19 depot repair service 3-year limited warranty**

Educational models are available only to public or private K-12 or higher accredited schools organized and operated exclusively for educational purposes for use by qualified students and teachers.

Positioning Processor	<i>Everyday computing; two spindles</i> Intel® Core™ 2 Duo processor T7100 or T7300 with dual-core, Intel 64 Technology, Enhanced Intel SpeedStep® technology ¹ , Intel Dynamic Acceleration, Execute Disable Bit, Virtualization Technology, 800MHz system bus, and 4MB shared L2 cache										Preloaded operating system²⁰ - Microsoft® Windows® Vista® Business Edition (32-bit) ◇ Vista Basic logo			
Memory	1GB std / 4GB max ⁷ / PC2-5300 667MHz DDR2, non-parity, dual-channel capable, two 200-pin SO-DIMM sockets; <i>Non-italics:</i> standard memory in 1 socket; 1 socket available										Preloaded applications¹⁴ • Microsoft Office OneNote® 2007 (and CD) • <i>Some (K12):</i> K-12 education software - VitalSource Library School Edition - Adobe® Instructor Resource Center - Adobe Digital School Collection - Photoshop Elements 5 (and CD) - Premier Elements 3 (and DVD) - Acrobat 8 Professional - Contribute 4 • <i>Some (HE):</i> Higher education software - VitalSource Library College Edition - Adobe Instructor Resource Center - Adobe Photoshop Elements 5 (and CD) - Adobe Premier Elements 3 (and DVD)			
Diskette drive	None (use optional USB-based diskette drive)										• Rescue and Recovery™ • Access Connections™ • Client Security Solution™ • ThinkVantage Productivity Center • ThinkVantage System Update • System Migration Assistant • Norton Internet Security™ (90 days of virus definitions) • Diskeeper® Home • PC-Doctor™ (diagnostics) • ThinkPad Utilities (Power Manager and Presentation Director) • Windows Live™ Toolbar • Picasa from Google • <i>Some:</i> Fingerprint Software • Microsoft Office 2007 Trial (60-day) • Sonic RecordNow and Drive Letter Access (combo, DVD±RW) • Corel® WinDVD® (combo, DVD±RW)			
EIDE Combo	<i>Some:</i> DVD-ROM/CD-RW (73P3288), 24X/24X/24X/8X ²¹ , removable Ultrabay™ Enh													
EIDE DVD±RW	<i>Some:</i> DVD burner, Super Multi-Burner (40Y8624) dual-layer, removable Ultrabay Enh										Supports ThinkVantage® technologies 65-watt (GMA graphics) AC adapter ThinkPad Roll Cage and Top Cover Roll Cage (one-piece magnesium) ENERGY STAR® 4.0-compliant RoHS-compliant International Warranty Service ¹⁷ 24 hour x 7 day ¹⁸ toll-free support during the warranty period ¹² via 800-426-7378			
Ultrabay Enhanced	One bay for removable devices, Ultrabay Slim-compatible, 12.7mm high													
Serial ATA disk	80GB⁸ (5400 rpm) or 120GB (5400 rpm) / SATA 1.5Gb/s, 9.5mm high, removable, upgradable, 9.5mm high bay, supports 2nd disk, ThinkPad Shock Mounted Hard Drive, Active Protection System™										ThinkPlus™,22 2-year LOR ²⁴ 9x5 NBD 41C9175 ThinkPlus 3-year LOR 9x5 NBD 41C9176 ThinkPlus 4-year LOR 9x5 NBD 41C9177 ThinkPlus 5-year LOR 9x5 NBD 41C9179 ThinkPlus 4-year P&L P/U Depot 41C9178 ThinkPlus 5-year P&L P/U Depot 41C9180			
Widescreen display	14.1" (358.1mm) WXGA (1280x800) color , anti-glare, 185 nits, 16:10 aspect ratio, 300:1 contrast ratio													
Camera	None										Other accessories at lenovo.com/accessories			
Graphics	Intel Graphics Media Accelerator X3100 (GMA X3100) , integrated in GM965, DVI pass-through support to optional Advanced Mini Dock or Advanced Dock													
Keyboard	89-key, ThinkVantage button, spill-resistant, multimedia Fn keys, Windows/Apl keys										Other accessories on O-R61-14W sheet			
TrackPoint®	TrackPoint® pointing device, "Press-to-Select," Internet Scroll Bar ¹³ , magnifying glass													
Touch pad	UltraNav™ multi-pointing system, touch pad below keyboard, Tap Zones										Other accessories on O-R61-14W sheet			
ThinkLight™	Illuminates the keyboard to improve visibility in low-light conditions													
Dimensions ³	<i>6-cell 14.1W" (WxDxH):</i> 13.2" x 10.2" x 1.2–1.37"; 335 x 261mm x 30.6–34.9mm										Other accessories on O-R61-14W sheet			
Weight ²	<i>6-cell:</i> starting at 5.5 lb (2.5kg)													
Case material	<i>Top:</i> Super-Elastic PolyCarbonate (SEPC); <i>Bottom:</i> Carbon-Fiber Reinforced Plastic										Other accessories on O-R61-14W sheet			
Battery - type	Lithium Ion 6-cell , supports unique 2nd battery in Ultrabay Slim													
Battery - life ¹⁰	<i>6-cell:</i> up to 5.7 hr; <i>6-cell plus Ultrabay battery:</i> up to 7.2 hr										Other accessories on O-R61-14W sheet			
Chipset	Mobile Intel GM965 Express Chipset (Graphics Memory Controller Hub); ICH8M-Enhanced I/O Controller Hub (SATA 3.0Gb/s, ATA-100 EIDE, PCI Express® x1, PCI bus, USB, LPC bus, [Bluetooth], [fingerprint]) / PCI bus (Ricoh® R5C847 Cardbus/1394/Multicard) / LPC bus (WPCN385 Super I/O, Atmel® 97SC3203 TPM)													
PC Card Std	One slot (Type I, Type II), CardBus 32-bit										Other accessories on O-R61-14W sheet			
ExpressCard slot	None													
Smart Card Read	None										Other accessories on O-R61-14W sheet			
Multicard Reader	4-in-1 reader (MultiMediaCard, Memory Stick® PRO™, Secure Digital, xD-Picture Card™)													
Ports	Three USB 2.0, DB-15 (external VGA monitor), RJ-11 (modem), RJ-45 (ethernet), IEEE 1394 FireWire 400 (4-pin connector; 1394a-2000 standard)										Other accessories on O-R61-14W sheet			
Wireless antenna	UltraConnect™ II antenna / on-off switch for all wireless radios													
Mini PCI Express	Two Mini PCI Express slots / only 802.11 wireless is customer upgradable										Other accessories on O-R61-14W sheet			
11a/b/g ³²	11a/b/g wireless ⁴ , ThinkPad 11a/b/g Mini PCIe Adapter, Atheros AR5006EX													
WWAN	None										Other accessories on O-R61-14W sheet			
Turbo Memory	None													
Modem	56K V.92 ⁶ modem in Communications Daughter Card socket										Other accessories on O-R61-14W sheet			
Bluetooth™	None													
Ethernet	Gigabit ethernet, Intel 82566MM Nineveh (PHY), PCIe x1 (GLCI), PXE										Other accessories on O-R61-14W sheet			
Intel AMT	None													
Audio support	High Definition (HD) Audio, AD1984HD codec / stereo speakers, 1 watt / volume up, down, mute buttons / internal microphone, microphone input jack, headphone jack										Other accessories on O-R61-14W sheet			
Security	Power-on password, hard disk password, supervisor password, security keyhole													
Security chip	Trusted Platform Module , Atmel chip, TCG 1.2-compliant										Other accessories on O-R61-14W sheet			
Fingerprint reader	<i>Some:</i> Fingerprint reader on palm rest , swipe sensor, supports the security chip													
Limited warranty ¹²	3-years/1-yr battery - EasyServ™,19 depot repair service / service upgrades ²² avail										Other accessories on O-R61-14W sheet			
1GB PC2-5300 DDR2 SODIMM	40Y7734			T/R 14W Standard Battery 4-cell			41U3196			ThinkPlus™,22 2-year LOR ²⁴ 9x5 NBD 41C9175				
2GB PC2-5300 DDR2 SODIMM	40Y7735			T/R 14W Enhanced Battery 6-cell			41U3198			ThinkPlus 3-year LOR 9x5 NBD 41C9176				
ThinkPad DVD Ultrabay Slim Burner (flat)	41N5643			T/R 14W High Capacity Batt 9-cell			43R2499			ThinkPlus 4-year LOR 9x5 NBD 41C9177				
Serial Hard Drive Ultrabay Slim Adapter (flat)	40Y8725			Advanced Ultrabay Battery II 3-cell			43R9250			ThinkPlus 5-year LOR 9x5 NBD 41C9179				
200GB Disk FDE SATA 1.5Gb/s (7200 rpm)	41N5738			ThinkPad External Battery Charger			40Y7625			ThinkPlus 4-year P&L P/U Depot 41C9178				
USB 2.0 Essential Memory Key 32GB	45K1258			ThinkPad 90W AC Adapter			40Y7659			ThinkPlus 5-year P&L P/U Depot 41C9180				
USB 2.0 Lenovo Enhanced Port Replicator	43R8770			90W Slim AC/DC Combo Adapter			41N8460			Other accessories on O-R61-14W sheet				
ThinkPad Essential Port Replicator	250510W			ThinkVision® L1940p Wide 19" Monitor			4424HB6			Other accessories on O-R61-14W sheet				
ThinkPad Advanced Mini Dock	250410U			ThinkVision L2240p Wide 22" Monitor			4422HB6			Other accessories on O-R61-14W sheet				
ThinkPad Advanced Dock	250310U			ThinkVision L2440x Wide 24" Monitor			4421HB2			Other accessories on O-R61-14W sheet				
Other accessories on O-R61-14W sheet											Other accessories on O-R61-14W sheet			

See footnotes for important warranty information
US models announced May 9, 2007

© Lenovo
(LAG1-5) May 2007

Type-model	Proc- essor	GHz	Memory	Wide- screen display	Graphics controller	Disk SATA GB ³ rpm	EIDE optical	Mini PCIe 802.11 wireless	Mini PCIe Intel Turbo Card slot	Finger print reader	Bat- tery cells	Vista pre- load	Educ pre- load	Workhorse (W) Limited Gbl (G) warranty ¹²	Avail date		
7735-1BU	T7300	2.00	1GB	14.1" WXGA	GMA	120G 5400	DVD±RW	11a/b/g ³²	None	4-in-1	Fing	6	B32	HE	Onsite	W	May 07
7735-1CU	T7100	1.80	1GB	14.1" WXGA	GMA	80G 5400	Combo	11a/b/g	None	4-in-1	Fing	6	B32	K12	Onsite	W	May 07

• **These models have a limited onsite service²⁴ 3-year limited warranty**

Educational models are available only to public or private K-12 or higher accredited schools organized and operated exclusively for educational purposes for use by qualified students and teachers.

Positioning Processor	<i>Everyday computing; two spindles</i> Intel® Core™ 2 Duo processor T7100 or T7300 with dual-core, Intel 64 Technology, Enhanced Intel SpeedStep® technology ¹ , Intel Dynamic Acceleration, Execute Disable Bit, Virtualization Technology, and 800MHz system bus; T7100: 2MB shared L2 cache; T7300: 4MB shared L2 cache										Preloaded operating system²⁰ - Microsoft® Windows® Vista® Business Edition (32-bit) ♦ Vista Basic logo				
Memory	1GB std / 4GB max ⁷ / PC2-5300 667MHz DDR2, non-parity, dual-channel capable, two 200-pin SO-DIMM sockets; <i>Non-italics:</i> standard memory in 1 socket; 1 socket available										Preloaded applications¹⁴ (all) • Microsoft Office OneNote® 2007 (and CD) • <i>Some (K12):</i> K-12 education software - VitalSource Library School Edition - Adobe® Instructor Resource Center - Adobe Digital School Collection - Photoshop Elements 5 (and CD) - Premier Elements 3 (and DVD) - Acrobat 8 Professional - Contribute 4 • <i>Some (HE):</i> Higher education software - VitalSource Library College Edition - Adobe Instructor Resource Center - Adobe Photoshop Elements 5 (and CD) - Adobe Premier Elements 3 (and DVD) • Rescue and Recovery™ • Access Connections™ • Client Security Solution™ • ThinkVantage Productivity Center • ThinkVantage System Update • System Migration Assistant • Norton Internet Security™ (90 days of virus definitions) • Diskeeper® Home • PC-Doctor™ (diagnostics) • ThinkPad Utilities (Power Manager and Presentation Director) • Adobe® Reader • Windows Live™ Toolbar • Windows Live Search • Picasa from Google • <i>Some:</i> Fingerprint Software • Microsoft Office 2007 Trial (60-day) • Sonic RecordNow and Drive Letter Access (combo, DVD±RW) • Corel® WinDVD® (combo, DVD±RW)				
Diskette drive	None (use optional USB-based diskette drive)														
EIDE Combo	<i>Some:</i> DVD-ROM/CD-RW (73P3288), 24X/24X/24X/8X ²¹ , removable Ultrabay™ Enh														
EIDE DVD±RW	<i>Some:</i> DVD burner, Super Multi-Burner (40Y8624) dual-layer, removable Ultrabay Enh														
Ultrabay Enhanced Serial ATA disk	One bay for removable devices, Ultrabay Slim-compatible, 12.7mm high 80GB⁸ (5400 rpm) or 120GB (5400 rpm) / SATA 1.5Gb/s, 9.5mm high, removable, upgradable, 9.5mm high bay, supports 2nd disk, ThinkPad Shock Mounted Hard Drive, Active Protection System™														
Widescreen display	14.1" (358.1mm) WXGA (1280x800) color , anti-glare, 185 nits, 16:10 aspect ratio, 300:1 contrast ratio														
Camera	None														
Graphics	Intel Graphics Media Accelerator X3100 (GMA X3100) , integrated in GM965, DVI pass-through support to optional Advanced Mini Dock or Advanced Dock														
Keyboard	89-key, ThinkVantage button, spill-resistant, multimedia Fn keys, Windows/Appl keys														
TrackPoint®	TrackPoint® pointing device, "Press-to-Select," Internet Scroll Bar ¹³ , magnifying glass														
Touch pad	UltraNav™ multi-pointing system, touch pad below keyboard, Tap Zones														
ThinkLight™	Illuminates the keyboard to improve visibility in low-light conditions														
Dimensions ³	<i>6-cell 14.1W" (WxDxH):</i> 13.2" x 10.2" x 1.2–1.37"; 335 x 261mm x 30.6–34.9mm														
Weight ²	<i>6-cell:</i> starting at 5.5 lb (2.5kg)														
Case material	<i>Top:</i> Super-Elastic PolyCarbonate (SEPC); <i>Bottom:</i> Carbon-Fiber Reinforced Plastic														
Battery - type	Lithium Ion 6-cell , supports unique 2nd battery in Ultrabay Slim														
Battery - life ¹⁰	<i>6-cell:</i> up to 5.7 hr; <i>6-cell plus Ultrabay battery:</i> up to 7.2 hr														
Chipset	Mobile Intel GM965 Express Chipset (Graphics Memory Controller Hub); ICH8M-Enhanced I/O Controller Hub (SATA 3.0Gb/s, ATA-100 EIDE, PCI Express® x1, PCI bus, USB, LPC bus, [Bluetooth], [fingerprint]) / PCI bus (Ricoh® R5C847 Cardbus/1394/Multicard) / LPC bus (WPCN385 Super I/O, Atmel® 97SC3203 TPM)														
PC Card Std slot	One Type I or Type II slot, CardBus 32-bit														
ExpressCard slot	None														
Smart Card Read	None														
Multicard Reader	4-in-1 reader (MultiMediaCard, Memory Stick® PRO™, Secure Digital, xD-Picture Card™)														
Ports	Three USB 2.0, DB-15 (external VGA monitor), RJ-11 (modem), RJ-45 (ethernet), IEEE 1394 FireWire 400 (4-pin connector; 1394a-2000 standard)														
Wireless antenna	UltraConnect™ II antenna / on-off switch for all wireless radios														
Mini PCI Express	Two Mini PCI Express slots / only 802.11 wireless is customer upgradable														
11a/b/g ³²	11a/b/g wireless ⁴ , ThinkPad 11a/b/g Mini PCIe Adapter, Atheros AR5006EX														
WWAN	None														
Turbo Memory	None														
Modem	56K V.92 ⁶ modem in Communications Daughter Card socket														
Bluetooth™	None														
Ethernet	Gigabit ethernet, Intel 82566MM Nineveh (PHY), PCIe x1 (GLCI), PXE														
Intel AMT	None														
Audio support	High Definition (HD) Audio, AD1984HD codec / stereo speakers, 1 watt / volume up, down, mute buttons / internal microphone, microphone input jack, headphone jack														
Security	Power-on password, hard disk password, supervisor password, security keyhole														
Security chip	Trusted Platform Module , Atmel chip, TCG 1.2-compliant														
Fingerprint reader	<i>Some:</i> Fingerprint reader on palm rest , swipe sensor, supports the security chip														
Limited warranty ¹²	3-years/1-year battery, limited onsite service²⁴, 8 am - 5 pm, Mon - Fri coverage excluding holidays, next business day response time										Supports ThinkVantage® technologies				
1GB PC2-5300 DDR2 SODIMM	40Y7734		T/R 14W Enhanced Battery 6-cell				41U3198				65-watt (GMA graphics) AC adapter ThinkPad Roll Cage and Top Cover Roll Cage (one-piece magnesium) ENERGY STAR® 4.0-compliant RoHS-compliant International Warranty Service ¹⁷ 24 hour x 7 day ¹⁸ toll-free support during the warranty period ¹² via 800-426-7378 Post-warranty annual maintenance agreements at lenovo.com/thinkplus/warranty				
2GB PC2-5300 DDR2 SODIMM	40Y7735		T/R 14W High Capacity Batt 9-cell				43R2499								
ThinkPad DVD Ultrabay Slim Burner (flat)	41N5643		Advanced Ultrabay Battery II 3-cell				43R9250								
Serial Hard Drive Ultrabay Slim Adapter (flat)	40Y8725		ThinkPad External Battery Charger				40Y7625								
320GB Disk SATA 1.5Gb/s (5400 rpm)	43N3403		90W Slim AC/DC Combo Adapter				41N8460								
USB 2.0 Portable Secure 320GB Hard Disk	43R2019		ThinkPad Business Topload Case				43R2476								
USB 2.0 Super Multi-Burner Drive	41N5565		ThinkPad Business Backpack				43R2482								
USB 2.0 Lenovo Enhanced Port Replicator	43R8770		ThinkVision® L1940p Wide 19" Monitor				4424HB6								
ThinkPad Essential Port Replicator	250510W		ThinkVision L2240p Wide 22" Monitor				4422HB6								
ThinkPad Advanced Dock	250310U		ThinkVision L2440p Wide 24" Monitor				4420HB2								
Other accessories on O-R61-14W sheet	Other accessories at lenovo.com/accessories														

See footnotes for important warranty information
 US models announced May 9, 2007

ThinkPad® R61u 14W 7733 (GMA) - Education (EasyServ)

Personal Systems Reference (PSREF)

Proc- Type-model	Processor GHz	Memory	Wide- screen display	Graphics controller	Cam- era	Disk SATA GB ⁸ rpm	EIDE optical	Mini PCIe 802.11 wireless	Mini PCIe Intel Turbo slot	Card slot	Blue- tooth	Finger print reader	Bat- tery cells	Vista pre- load	Workhorse (W) Limited Gbl (G) Avail warranty ¹² date	
7733-PAU	T8300	2.40	1GB	14.1" WXGA	GMA	80G 5400	Combo	11a/b/g	None	/54			6	B32	EasyServ No Feb 08	
7733-PBU	T8300	2.40	1GB	14.1" WXGA+	GMA Cam	100G 7200	DVD±RW	11a/b/g	None	/54	Blue	Fing	6	B32	EasyServ No Feb 08	
7733-05U	T8300	2.40	2GB	14.1" WXGA	GMA Cam	160G 5400	DVD±RW	11a/b/g	None	4-in-1	Blue	Fing	6	B32	EasyServ No Apr 08	
<i>Italic MTM: not a base model for building a custom model</i>																
<ul style="list-style-type: none"> • These models have an EasyServ™¹⁹ depot repair service 3-year limited warranty 																
Educational models are available only to public or private K-12 or higher accredited schools organized and operated exclusively for educational purposes for use by qualified students and teachers.																
Positioning Processor	<i>Everyday computing; two spindles</i> Intel® Core™ 2 Duo processor T8300 with dual-core. Intel 64 Technology, Enhanced Intel SpeedStep® technology ¹ , Intel Dynamic Acceleration, Execute Disable Bit, Virtualization Technology, 800MHz system bus, and 3MB shared L2 cache											Preloaded operating system²⁰ - Microsoft® Windows® Vista® Business Edition (32-bit) ◇ Vista Basic logo				
Memory	1GB or 2GB std / 4GB max ⁷ / PC2-5300 667MHz DDR2, non-parity, dual-channel capable, two 200-pin SO-DIMM sockets; <i>Italics:</i> standard memory in both sockets; no sockets available; <i>Non-italics:</i> standard memory in 1 socket; 1 socket available											Preloaded applications¹⁴ • Microsoft Office OneNote® 2007 (and CD) • Education software - VitalSource Library College Edition - Adobe® Instructor Resource Cntr - Adobe Digital School Collection - Photoshop Elements (and CD) - Premier Elements (and DVD) - Acrobat 8 Professional - Contribute 4 • Rescue and Recovery™ • Access Connections™ • Client Security Solution™ • ThinkVantage Productivity Center • ThinkVantage System Update • System Migration Assistant • Norton Internet Security™ (90 days of virus definitions) • Diskeeper® Home • PC-Doctor™ (diagnostics) • ThinkPad Utilities (Power Manager and Presentation Director) • Adobe® Reader • Windows Live™ Toolbar • Windows Live Search • Picasa from Google • <i>Some:</i> Fingerprint Software • Microsoft Office 2007 Trial (60-day) • Sonic RecordNow and Drive Letter Access (combo, DVD±RW) • Corel® WinDVD® (combo, DVD±RW)				
Diskette drive	None (use optional USB-based diskette drive)															
EIDE Combo	<i>Some:</i> DVD-ROM/CD-RW (73P3288), 24X/24X/24X/8X ²¹ , removable Ultrabay™ Enh															
EIDE DVD±RW	<i>Some:</i> DVD burner, Super Multi-Burner (40Y8624) dual-layer, removable Ultrabay Enh															
Ultrabay Enhanced	One bay for removable devices, Ultrabay Slim-compatible, 12.7mm high															
Serial ATA disk	80GB⁸ (5400 rpm), 100GB (7200 rpm), or 160GB (5400 rpm) / SATA 1.5Gb/s 9.5mm high, removable, upgradable, 9.5mm high bay, supports 2nd disk, ThinkPad Shock Mounted Hard Drive, Active Protection System™															
Widescreen display	<i>Some:</i> 14.1" (358.1mm) WXGA (1280x800) color , anti-glare, 185 nits, 16:10, 300:1 <i>Some:</i> 14.1" (358.1mm) WXGA+ (1440x900) color , anti-glare, 200 nits, 16:10, 300:1															
Camera	<i>Some:</i> camera on top of screen, 1.3-megapixel, fixed focus, USB 2.0															
Graphics	Intel Graphics Media Accelerator X3100 (GMA X3100) , integrated in GM965, DVI pass-through support to optional Advanced Mini Dock or Advanced Dock															
Keyboard	89-key, ThinkVantage button, spill-resistant, multimedia Fn keys, Windows/Appl keys															
TrackPoint®	TrackPoint® pointing device, "Press-to-Select," Internet Scroll Bar ¹³ , magnifying glass															
Touch pad	UltraNav™ multi-pointing system, touch pad below keyboard, Tap Zones															
ThinkLight™	Illuminates the keyboard to improve visibility in low-light conditions															
Dimensions ³	<i>6-cell 14.1W"</i> (WxDxH): 13.2" x 10.2" x 1.2–1.37"; 335 x 261mm x 30.6–34.9mm															
Weight ²	<i>6-cell:</i> starting at 5.5 lb (2.5kg)															
Case material	<i>Top:</i> Super-Elastic PolyCarbonate (SEPC); <i>Bottom:</i> Carbon-Fiber Reinforced Plastic															
Battery - type	Lithium Ion 6-cell , supports unique 2nd battery in Ultrabay Slim															
Battery - life ¹⁰	<i>6-cell:</i> up to 5.7 hr; <i>6-cell plus Ultrabay battery:</i> up to 7.2 hr															
Chipset	Mobile Intel GM965 Express Chipset (Graphics Memory Controller Hub); ICH8M-Enhanced I/O Controller Hub (SATA 3.0Gb/s, ATA-100 EIDE, PCI Express® x1, PCI bus, USB, LPC bus, [Bluetooth], [fingerprint]) / PCI bus (Ricoh® R5C847 Cardbus/1394/Multicard) / LPC bus (WPCN385 Super I/O, Atmel® 97SC3203 TPM)															
PC Card Std slot	One Type I or Type II slot, CardBus 32-bit															
ExpressCard slot	<i>Some:</i> [/54] One ExpressCard/34 or ExpressCard/54															
Smart Card Read	None															
Multicard Reader	<i>Some:</i> 4-in-1 reader (MultiMediaCard, Mem Stick® PRO, Sec Digital, xD-Picture Card™)															
Ports	Three USB 2.0, DB-15 (external VGA monitor), RJ-11 (modem), RJ-45 (ethernet), IEEE 1394 FireWire 400 (4-pin connector; 1394a-2000 standard)															
Wireless antenna	UltraConnect™ II antenna / on-off switch for all wireless radios															
Mini PCI Express	Two Mini PCI Express slots / only 802.11 wireless is customer upgradable															
11a/b/g ³²	11a/b/g wireless ⁴ , ThinkPad 11a/b/g Mini PCIe Adapter, Atheros AR5006EX															
WWAN	None															
Turbo Memory	None															
Modem	56K V.92 ⁶ modem in Communications Daughter Card socket															
Bluetooth™	<i>Some:</i> Bluetooth 2.0 wireless, USB 2.0 interface via ICH8M, LED indicator															
Ethernet	Gigabit ethernet, Intel 82566MM Nineveh (PHY), PCIe x1 (GLCI), PXE															
Intel AMT	None															
Audio support	High Definition (HD) Audio, AD1984HD codec / stereo speakers, 1 watt / volume up, down, mute buttons / internal microphone, microphone input jack, headphone jack															
Security	Power-on password, hard disk password, supervisor password, security keyhole															
Security chip	Trusted Platform Module , Atmel chip, TCG 1.2-compliant															
Fingerprint reader	<i>Some:</i> Fingerprint reader on palm rest , swipe sensor, supports the security chip															
Limited warranty ¹² 3-years/1-yr battery - EasyServ™ ¹⁹ depot repair service / service upgrades ²² available																
512MB PC2-5300 DDR2 SODIMM	40Y7733	T/R 14W Standard Battery 4-cell										41U3196	ThinkPlus™ ²² 2-year LOR ²⁴ 9x5 NBD			
1GB PC2-5300 DDR2 SODIMM	40Y7734	T/R 14W Enhanced Battery 6-cell										41U3198	41C9175			
2GB PC2-5300 DDR2 SODIMM	40Y7735	T/R 14W High Capacity Batt 9-cell										43R2499	ThinkPlus 3-year LOR 9x5 NBD			
ThinkPad DVD Ultrabay Slim Burner (flat)	41N5643	Advanced Ultrabay Battery II 3-cell										43R9250	41C9176			
Serial Hard Drive Ultrabay Slim Adapter (flat)	40Y8725	ThinkPad External Battery Charger										40Y7625	ThinkPlus 4-year LOR 9x5 NBD			
320GB Disk SATA 1.5Gb/s (5400 rpm)	43N3403	ThinkPad 90W AC Adapter										40Y7659	41C9177			
ThinkPad Adjustable Notebook Stand	40Y7676	90W Slim AC/DC Combo Adapter										41N8460	ThinkPlus 5-year LOR 9x5 NBD			
ThinkPad Essential Port Replicator	250510W	ThinkVision® L1940p Wide 19" Monitor										4424HB6	41C9178			
ThinkPad Advanced Mini Dock	250410U	ThinkVision L2240p Wide 22" Monitor										4422HB6	ThinkPlus 4-year P&L P/U Depot			
ThinkPad Advanced Dock	250310U	ThinkVision L2440p Wide 24" Monitor										4420HB2	41C9179			
Other accessories on O-R61-14W sheet																
Other accessories at lenovo.com/accessories																
Post-warranty annual maintenance agreements at lenovo.com/thinkplus/warranty																

See footnotes for important warranty information

US model announced April 10, 2008; previous models on February 19, 2008

© Lenovo (LAG2-1) April 2008

Proc- Type-model	essor GHz	Memory	Wide- screen display	Graphics controller	Cam- era	Disk SATA GB ² rpm	EIDE optical	Mini PCIe 802.11 wireless	Mini PCIe Intel Turbo	Card slot	Bat- tery cells	Linux preload	Limited warranty ¹²	Workhorse (W) Gbl (G) Avail date
7733-3AU T8100	2.10	1GB	14.1" WXGA	GMA	No	80G 5400	Combo	*Intel 11a/b/g ³²	None	/54	6	SLED10	EasyServ	No Feb 08

• **This model has an EasyServ™.19 depot repair service 3-year limited warranty**

Educational models are available only to public or private K-12 or higher accredited schools organized and operated exclusively for educational purposes for use by qualified students and teachers.

Positioning Processor	<i>Everyday computing; two spindles</i> Intel® Core™ 2 Duo processor T8100 with dual-core, Intel 64 Technology, Enhanced Intel SpeedStep® technology ¹ , Intel Dynamic Acceleration, Execute Disable Bit, Virtualization Technology, 800MHz system bus, and 3MB shared L2 cache										Preloaded operating system²⁰ - SUSE® Linux™ Enterprise Desktop10 Service Pack 1 Preloaded applications¹⁴ • None			
Memory	1GB std / 4GB max ⁷ / PC2-5300 667MHz DDR2, non-parity, dual-channel capable, two 200-pin SO-DIMM sockets; <i>Non-italics:</i> standard memory in 1 socket; 1 socket available										Supported devices (only some listed) • HD Audio • Intel 3945ABG wireless • Intel Graphics Media Accelerator X3100 (GMA X3100) • NVIDIA Quadro NVS 140M • Fingerprint reader • Bluetooth • Function keys • ThinkPad Advanced Dock			
Diskette drive	None (use optional USB-based diskette drive)										Non-supported devices (only some listed) • Intel 4965AG, Intel 4965AGN, ThinkPad 11a/b/g, ThinkPad 11n wireless • WWAN • Active Protection System™ • ThinkVantage® button • Security chip • Intel Turbo Memory • Intel AMT technology • Integrated camera			
EIDE Combo	DVD-ROM/CD-RW (73P3288), 24X/24X/24X/8X ²¹ , removable Ultrabay™ Enhanced													
Ultrabay Enhanced	One bay for removable devices, Ultrabay Slim-compatible, 12.7mm high										Non-supported applications (only some listed) • ThinkPad Utilities • ThinkVantage technologies • Presentation Director • Encrypted DVD playback • Keyboard Customizer			
Serial ATA disk	80GB⁸ (5400 rpm) / SATA 1.5Gb/s, 9.5mm high, removable, upgradable, 9.5mm high bay, supports 2nd disk, ThinkPad Shock Mounted Hard Drive, Active Protection System™													
Widescreen display	<i>Some:</i> 14.1" (358.1mm) WXGA (1280x800) color , anti-glare, 185 nits, 16:10 aspect ratio, 300:1 contrast ratio										Supports ThinkVantage® technologies 65-watt (GMA graphics) AC adapter ThinkPad Roll Cage and Top Cover Roll Cage (one-piece magnesium) ENERGY STAR® 4.0-compliant RoHS-compliant International Warranty Service ¹⁷ 24 hour x 7 day ¹⁸ toll-free support during the warranty period ¹² via 800-426-7378 ThinkPlus™.22 2-year LOR ²⁴ 9x5 NBD 41C9175 ThinkPlus 3-year LOR 9x5 NBD 41C9176 ThinkPlus 4-year LOR 9x5 NBD 41C9177 ThinkPlus 5-year LOR 9x5 NBD 41C9179 ThinkPlus 4-year P&L P/U Depot 41C9178 ThinkPlus 5-year P&L P/U Depot 41C9180 Post-warranty annual maintenance agreements at lenovo.com/thinkplus/warranty			
Camera	None													
Graphics	Intel Graphics Media Accelerator X3100 (GMA X3100) , integrated in GM965													
Keyboard	89-key, ThinkVantage button, spill-resistant, multimedia Fn keys, Windows/Apl keys													
TrackPoint®	TrackPoint® pointing device, "Press-to-Select," Internet Scroll Bar ¹³ , magnifying glass													
Touch pad	UltraNav™ multi-pointing system, touch pad below keyboard, Tap Zones													
ThinkLight™	Illuminates the keyboard to improve visibility in low-light conditions													
Dimensions ³	<i>6-cell 14.1W"</i> (WxDxH): 13.2" x 10.2" x 1.2–1.37"; 335 x 261mm x 30.6–34.9mm													
Weight ²	<i>6-cell:</i> starting at 5.5 lb (2.5kg)													
Case material	<i>Top:</i> Super-Elastic PolyCarbonate (SEPC); <i>Bottom:</i> Carbon-Fiber Reinforced Plastic													
Battery - type	Lithium Ion 6-cell , supports unique 2nd battery in Ultrabay Slim													
Battery - life ¹⁰	<i>6-cell:</i> up to 5.7 hr; <i>6-cell plus Ultrabay battery:</i> up to 7.2 hr													
Chipset	Mobile Intel GM965 Express Chipset (Graphics Memory Controller Hub); ICH8M-Enhanced I/O Controller Hub (SATA 3.0Gb/s, ATA-100 EIDE, PCI Express® x1, PCI bus, USB, LPC bus, [Bluetooth], [fingerprint]) / PCI bus (Ricoch® R5C847 Cardbus/1394/Multicard) / LPC bus (WPCN385 Super I/O, Atmel® 97SC3203 TPM)													
PC Card Std slot	One Type I or Type II slot, CardBus 32-bit													
ExpressCard slot	[/54] One ExpressCard/34 or ExpressCard/54													
Smart Card Read	None													
Multicard Reader	None													
Ports	Three USB 2.0, DB-15 (external VGA monitor), RJ-11 (modem), RJ-45 (ethernet), IEEE 1394 FireWire 400 (4-pin connector; 1394a-2000 standard)													
Wireless antenna	UltraConnect™ II antenna / on-off switch for all wireless radios													
Mini PCI Express	Two Mini PCI Express slots / only 802.11 wireless is customer upgradable													
Intel 11a/b/g ³²	11a/b/g wireless ⁴ , Mini PCIe adapter, Intel PRO/Wireless 3945ABG													
WWAN	None													
Turbo Memory	None													
Modem	56K V.92 ⁶ modem in Communications Daughter Card socket													
Bluetooth™	None													
Ethernet	Gigabit ethernet, Intel 82566MM Nineveh (PHY), PCIe x1 (GLCI), PXE													
Intel AMT	None													
Audio support	High Definition (HD) Audio, AD1984HD codec / stereo speakers, 1 watt / volume up, down, mute buttons / internal microphone, microphone input jack, headphone jack													
Security	Power-on password, hard disk password, supervisor password, security keyhole													
Security chip	Trusted Platform Module , Atmel chip, TCG 1.2-compliant													
Fingerprint reader	None													
Limited warranty ¹²	3-years/1-yr battery - EasyServ™.19 depot repair service / service upgrades²² available													
512MB PC2-5300 DDR2 SODIMM	40Y7733			T/R 14W Standard Battery 4-cell			41U3196							
1GB PC2-5300 DDR2 SODIMM	40Y7734			T/R 14W Enhanced Battery 6-cell			41U3198							
2GB PC2-5300 DDR2 SODIMM	40Y7735			T/R 14W High Capacity Batt 9-cell			43R2499							
ThinkPad DVD Ultrabay Slim Burner (flat)	41N5643			Advanced Ultrabay Battery II 3-cell			43R9250							
Serial Hard Drive Ultrabay Slim Adapter (flat)	40Y8725			ThinkPad External Battery Charger			40Y7625							
200GB Disk FDE SATA 1.5Gb/s (7200 rpm)	41N5738			ThinkPad 90W AC Adapter			40Y7659							
ThinkPad Adjustable Notebook Stand	40Y7676			90W Slim AC/DC Combo Adapter			41N8460							
ThinkPad Essential Port Replicator	250510W			ThinkVision® L1940p Wide 19" Monitor			4424HB6							
ThinkPad Advanced Mini Dock	250410U			ThinkVision L2240p Wide 22" Monitor			4422HB6							
ThinkPad Advanced Dock	250310U			ThinkVision L2440x Wide 24" Monitor			4421HB2							
Check Linux compatibility for other accessories	Other accessories at lenovo.com/accessories													

See footnotes for important warranty information
US model announced February 19, 2008

* Intel Centrino® processor technology

ThinkPad® R61u 14W 7743 (NVIDIA) - Education (EasyServ)

Personal Systems Reference (PSREF)

Proc- Type-model GHz Memory	Wide- screen display	Graphics controller	Disk SATA GB ³ rpm	EIDE optical	Mini PCIe 802.11 wireless	Mini PCIe Intel Turbo Card slot	Cam- era	Blue- tooth	Finger print reader	Bat- tery cells	Vista pre- load	Workhorse (W) Limited Gbl (G) warranty ¹²	Avail date
7743-N4U T8300 2.40 1GB 14.1" WXGA+	128MB 100G 7200 DVD±RW	11a/b/g	None 4-in-1 Cam Blue	Fing 6 B32 EasyServ No Feb 08									
7743-05U T8300 2.40 2GB 14.1" WXGA+	128MB 160G 5400 DVD±RW	11a/b/g	None 4-in-1 Cam Blue	Fing 6 B32 EasyServ No Apr 08									
<i>Italic MTM: not a base model for building a custom model</i>													
<ul style="list-style-type: none"> • These models have an EasyServ™¹⁹ depot repair service 3-year limited warranty <p>Educational models are available only to public or private K-12 or higher accredited schools organized and operated exclusively for educational purposes for use by qualified students and teachers.</p>													
Positioning Processor	<i>Everyday computing; two spindles</i> Intel® Core™ 2 Duo processor T8300 with dual-core, Intel 64 Technology, Enhanced Intel SpeedStep® technology ¹ , Intel Dynamic Acceleration, Execute Disable Bit, Virtualization Technology, 800MHz system bus, and 3MB shared L2 cache										Preloaded operating system²⁰ - Microsoft® Windows® Vista® Business Edition (32-bit) ◇ Vista Basic logo		
Memory	1GB or 2GB std / 4GB max ⁷ / PC2-5300 667MHz DDR2, non-parity, dual-channel capable, two 200-pin SO-DIMM sockets; <i>Non-italics:</i> standard memory in 1 socket; 1 socket available										Preloaded applications¹⁴ • Microsoft Office OneNote® 2007 (and CD) • Education software - VitalSource Library College Edition - Adobe® Instructor Resource Cntr - Adobe Digital School Collection - Photoshop Elements (and CD) - Premier Elements (and DVD) - Acrobat 8 Professional - Contribute 4 • Rescue and Recovery™ • Access Connections™ • Client Security Solution™ • ThinkVantage Productivity Center • ThinkVantage System Update • System Migration Assistant • Norton Internet Security™ (90 days of virus definitions) • Diskeeper® Home • PC-Doctor™ (diagnostics) • ThinkPad Utilities (Power Manager and Presentation Director) • Adobe® Reader • Windows Live™ Toolbar • Windows Live Search • Picasa from Google • Some: Fingerprint Software • Microsoft Office 2007 Trial (60-day) • Sonic RecordNow and Drive Letter Access (DVD±RW) • Corel® WinDVD® (DVD±RW)		
Diskette drive EIDE DVD±RW Ultrabay Enhanced Serial ATA disk	None (use optional USB-based diskette drive) DVD burner, Super Multi-Burner (40Y8624) dual-layer, removable Ultrabay Enhanced One bay for removable devices, Ultrabay Slim-compatible, 12.7mm high 100GB (7200 rpm) or 160GB (5400 rpm) / SATA 1.5Gb/s, 9.5mm high, removable, upgradable, 9.5mm high bay, supports 2nd disk, ThinkPad Shock Mounted Hard Drive, Active Protection System™												
Widescreen display Camera	14.1" (358.1mm) WXGA+ (1440x900) color , anti-glare, 200 nits, 16:10 aspect ratio, 300:1 contrast ratio Camera on top of screen, 1.3-megapixel, fixed focus, USB 2.0												
Graphics	NVIDIA® Quadro® NVS 140M , PCI Express® x16, 128MB memory, TurboCache, DVI pass-through support to optional Advanced Mini Dock or Advanced Dock												
Keyboard TrackPoint® Touch pad ThinkLight™	89-key, ThinkVantage button, spill-resistant, multimedia Fn keys, Windows/Appl keys TrackPoint® pointing device, "Press-to-Select," Internet Scroll Bar ¹³ , magnifying glass UltraNav™ multi-pointing system, touch pad below keyboard, Tap Zones Illuminates the keyboard to improve visibility in low-light conditions												
Dimensions ³ Weight ² Case material Battery - type Battery - life ¹⁰	6-cell 14.1W" (WxDxH): 13.2" x 10.2" x 1.2–1.37"; 335 x 261mm x 30.6–34.9mm 6-cell: starting at 5.5 lb (2.5kg) <i>Top:</i> Super-Elastic PolyCarbonate (SEPC); <i>Bottom:</i> Carbon-Fiber Reinforced Plastic Lithium Ion 6-cell , supports unique 2nd battery in Ultrabay Slim 6-cell: up to 5.7 hr; 6-cell plus Ultrabay battery: up to 7.2 hr												
Chipset	Mobile Intel PM965 Express Chipset (Memory Controller Hub); ICH8M-Enhanced I/O Controller Hub (SATA 3.0Gb/s, ATA-100 EIDE, PCI Express x1, PCI bus, USB, LPC bus, [Bluetooth], [fingerprint]) / PCI bus (Ricoch® R5C847 Cardbus/1394/Multicard) / LPC bus (WPCN385 Super I/O, Atmel® 97SC3203 TPM)												
PC Card ExpressCard slot Smart Card Read Multicard Reader Ports	One slot (Type I, Type II), CardBus 32-bit None None 4-in-1 reader (MultiMediaCard, Memory Stick® PRO™, Secure Digital, xD-Picture Card™) Three USB 2.0, DB-15 (external VGA monitor), RJ-11 (modem), RJ-45 (ethernet), IEEE 1394 FireWire 400 (4-pin connector; 1394a-2000 standard)												
Wireless antenna Mini PCI Express 11a/b/g ³² WWAN Turbo Memory	UltraConnect™ II antenna / on-off switch for all wireless radios Two Mini PCI Express slots / only 802.11 wireless is customer upgradable 11a/b/g wireless ¹ , ThinkPad 11a/b/g Mini PCIe Adapter, Atheros AR5006EX None None										Supports ThinkVantage® technologies		
Modem Bluetooth™ Ethernet Intel AMT Audio support	56K V.92 ⁶ modem in Communications Daughter Card socket Bluetooth 2.0 wireless, USB 2.0 interface via ICH8M, LED indicator Gigabit ethernet, Intel 82566MM Nineveh (PHY), PCIe x1 (GLCI), PXE None High Definition (HD) Audio, AD1984HD codec / stereo speakers, 1 watt / volume up, down, mute buttons / internal microphone, microphone input jack, headphone jack										65-watt (GMA graphics) AC adapter ThinkPad Roll Cage and Top Cover Roll Cage (one-piece magnesium) ENERGY STAR® 4.0-compliant RoHS-compliant International Warranty Service ¹⁷ 24 hour x 7 day ¹⁸ toll-free support during the warranty period ¹² via 800-426-7378		
Security Security chip Fingerprint reader	Power-on password, hard disk password, supervisor password, security keyhole Trusted Platform Module , Atmel chip, TCG 1.2-compliant Fingerprint reader on palm rest , swipe sensor, supports the security chip										ThinkPlus™.22 2-year LOR ²⁴ 9x5 NBD 41C9175		
Limited warranty ¹²	3-years/1-yr battery - EasyServ™¹⁹ depot repair service / service upgrades²² available										ThinkPlus 3-year LOR 9x5 NBD 41C9176		
512MB PC2-5300 DDR2 SODIMM 1GB PC2-5300 DDR2 SODIMM 2GB PC2-5300 DDR2 SODIMM ThinkPad DVD Ultrabay Slim Burner (flat) Serial Hard Drive Ultrabay Slim Adapter (flat) 200GB Disk FDE SATA 1.5Gb/s (7200 rpm) USB 2.0 Essential Memory Key 32GB ThinkPad Essential Port Replicator ThinkPad Advanced Mini Dock ThinkPad Advanced Dock Other accessories on O-R61-14W sheet	40Y7733 40Y7734 40Y7735 41N5643 40Y8725 41N5738 45K1258 250510W 250410U 250310U	T/R 14W Standard Battery 4-cell T/R 14W Enhanced Battery 6-cell T/R 14W High Capacity Batt 9-cell Advanced Ultrabay Battery II 3-cell ThinkPad External Battery Charger ThinkPad 90W AC Adapter 90W Slim AC/DC Combo Adapter ThinkVision® L1940p Wide 19" Monitor ThinkVision L2240p Wide 22" Monitor ThinkVision L2440x Wide 24" Monitor	41U3196 41U3198 43R2499 43R9250 40Y7625 40Y7659 41N8460 4424HB6 4422HB6 4421HB2	ThinkPlus 4-year LOR 9x5 NBD 41C9177 ThinkPlus 5-year LOR 9x5 NBD 41C9179 ThinkPlus 4-year P&L P/U Depot 41C9178 ThinkPlus 5-year P&L P/U Depot 41C9180 Post-warranty annual maintenance agreements at lenovo.com/thinkplus/warranty									

See footnotes for important warranty information

US model announced April 10, 2008; previous model on February 19, 2008

© Lenovo
(LAG2-2) April 2008

ThinkPad® R61u 14W 7743 (NVIDIA) - Education (EasyServ) - Linux

Personal Systems Reference (PSREF)

Proc- Type-model	essor GHz	Memory	Wide- screen display	Graphics controller	Disk SATA GB ⁸ rpm	EIDE optical	Mini PCIe 802.11 wireless	Mini PCIe Intel Turbo slot	Card Blue- tooth	Finger print reader	Bat- tery cells	Linux pre- load	Workhorse (W) Limited Gbl (G) warranty ¹²	Avail date	
7743-3BU	T8300	2.40 1GB	14.1" WXGA+	128MB	120G 5400	DVD±RW	*Intel 11a/b/g ³²	None /54	Blue	None	6	SLED10	EasyServ No	Feb 08	
<p>• This model has an EasyServ™.19 depot repair service 3-year limited warranty</p> <p>Educational models are available only to public or private K-12 or higher accredited schools organized and operated exclusively for educational purposes for use by qualified students and teachers.</p>															
Positioning Processor	<p><i>Everyday computing; two spindles</i> Intel® Core™ 2 Duo processor T8300 with dual-core, Intel 64 Technology, Enhanced Intel SpeedStep® technology¹, Intel Dynamic Acceleration, Execute Disable Bit, Virtualization Technology, 800MHz system bus, and 3MB shared L2 cache</p>										<p>Preloaded operating system²⁰ - SUSE® Linux™ Enterprise Desktop10 Service Pack 1</p> <p>Preloaded applications¹⁴ • None</p> <p>Supported devices (only some listed) • HD Audio • Intel 3945ABG wireless • Intel Graphics Media Accelerator X3100 (GMA X3100) • NVIDIA Quadro NVS 140M • Fingerprint reader • Bluetooth • Function keys • ThinkPad Advanced Dock</p> <p>Non-supported devices (only some listed) • Intel 4965AG, Intel 4965AGN, ThinkPad 11a/b/g, ThinkPad 11n wireless • WWAN • Active Protection System™ • ThinkVantage® button • Security chip • Intel Turbo Memory • Intel AMT technology • Integrated camera</p> <p>Non-supported applications (only some listed) • ThinkPad Utilities • ThinkVantage technologies • Presentation Director • Encrypted DVD playback • Keyboard Customizer</p>				
Memory	<p>1GB std / 4GB max⁷ / PC2-5300 667MHz DDR2, non-parity, dual-channel capable, two 200-pin SO-DIMM sockets; <i>Non-italics:</i> standard memory in 1 socket; 1 socket available</p>														
Diskette drive	None (use optional USB-based diskette drive)														
EIDE DVD±RW	DVD burner, Super Multi-Burner (40Y8624) dual-layer, removable Ultrabay Enhanced														
Ultrabay Enhanced	One bay for removable devices, Ultrabay Slim-compatible, 12.7mm high														
Serial ATA disk	<p>120GB (5400 rpm) / SATA 1.5Gb/s, 9.5mm high, removable, upgradable, 9.5mm high bay, supports 2nd disk, ThinkPad Shock Mounted Hard Drive, Active Protection System™</p>														
Widescreen display	14.1" (358.1mm) WXGA+ (1440x900) color , anti-glare, 200 nits, 16:10 aspect ratio, 300:1 contrast ratio														
Camera	None														
Graphics	NVIDIA® Quadro® NVS 140M , PCI Express® x16, 128MB memory, TurboCache, DVI pass-through support to optional Advanced Mini Dock or Advanced Dock														
Keyboard	89-key, ThinkVantage button, spill-resistant, multimedia Fn keys, Windows/Appl keys														
TrackPoint®	TrackPoint® pointing device, "Press-to-Select," Internet Scroll Bar ¹³ , magnifying glass														
Touch pad	UltraNav™ multi-pointing system, touch pad below keyboard, Tap Zones														
ThinkLight™	Illuminates the keyboard to improve visibility in low-light conditions														
Dimensions ³	<i>6-cell 14.1W" (WxDxH):</i> 13.2" x 10.2" x 1.2–1.37"; 335 x 261mm x 30.6–34.9mm														
Weight ²	<i>6-cell:</i> starting at 5.5 lb (2.5kg)														
Case material	<i>Top:</i> Super-Elastic PolyCarbonate (SEPC); <i>Bottom:</i> Carbon-Fiber Reinforced Plastic														
Battery - type	Lithium Ion 6-cell , supports unique 2nd battery in Ultrabay Slim														
Battery - life ¹⁰	<i>6-cell:</i> up to 5.7 hr; <i>6-cell plus Ultrabay battery:</i> up to 7.2 hr														
Chipset	<p>Mobile Intel PM965 Express Chipset (Memory Controller Hub); ICH8M-Enhanced I/O Controller Hub (SATA 3.0Gb/s, ATA-100 EIDE, PCI Express x1, PCI bus, USB, LPC bus, [Bluetooth], [fingerprint]) / PCI bus (Ricoch® R5C847 Cardbus/1394/Multicard) / LPC bus (WPCN385 Super I/O, Atmel® 97SC3203 TPM)</p>														
PC Card Std slot	One Type I or Type II slot, CardBus 32-bit														
ExpressCard slot	[/54] One ExpressCard/34 or ExpressCard/54														
Smart Card Read	None														
Multicard Reader	None														
Ports	Three USB 2.0, DB-15 (external VGA monitor), RJ-11 (modem), RJ-45 (ethernet), IEEE 1394 FireWire 400 (4-pin connector; 1394a-2000 standard)														
Wireless antenna	UltraConnect™ II antenna / on-off switch for all wireless radios														
Mini PCI Express	Two Mini PCI Express slots / only 802.11 wireless is customer upgradable														
Intel 11a/b/g ³²	11a/b/g wireless ⁴ , Mini PCIe adapter, Intel PRO/Wireless 3945ABG														
WWAN	None														
Turbo Memory	None														
Modem	56K V.92 ⁶ modem in Communications Daughter Card socket														
Bluetooth™	Bluetooth 2.0 wireless, USB 2.0 interface via ICH8M, LED indicator														
Ethernet	Gigabit ethernet, Intel 82566MM Nineveh (PHY), PCIe x1 (GLCI), PXE														
Intel AMT	None														
Audio support	High Definition (HD) Audio, AD1984HD codec / stereo speakers, 1 watt / volume up, down, mute buttons / internal microphone, microphone input jack, headphone jack														
Security	Power-on password, hard disk password, supervisor password, security keyhole														
Security chip	Trusted Platform Module , Atmel chip, TCG 1.2-compliant														
Fingerprint reader	None														
Limited warranty ¹² 3-years/1-yr battery - EasyServ™.19 depot repair service / service upgrades²² available															
512MB PC2-5300 DDR2 SODIMM	40Y7733				T/R 14W Standard Battery 4-cell				41U3196						
1GB PC2-5300 DDR2 SODIMM	40Y7734				T/R 14W Enhanced Battery 6-cell				41U3198						
2GB PC2-5300 DDR2 SODIMM	40Y7735				T/R 14W High Capacity Batt 9-cell				43R2499						
ThinkPad DVD Ultrabay Slim Burner (flat)	41N5643				Advanced Ultrabay Battery II 3-cell				43R9250						
Serial Hard Drive Ultrabay Slim Adapter (flat)	40Y8725				ThinkPad External Battery Charger				40Y7625						
320GB Disk SATA 1.5Gb/s (5400 rpm)	43N3403				ThinkPad 90W AC Adapter				40Y7659						
ThinkPad Adjustable Notebook Stand	40Y7676				90W Slim AC/DC Combo Adapter				41N8460						
ThinkPad Essential Port Replicator	250510W				ThinkVision® L1940p Wide 19" Monitor				4424HB6						
ThinkPad Advanced Mini Dock	250410U				ThinkVision L2240p Wide 22" Monitor				4422HB6						
ThinkPad Advanced Dock	250310U				ThinkVision L2440p Wide 24" Monitor				4420HB2						
Check Linux compatibility for other accessories															
<p>Other accessories at lenovo.com/accessories</p> <p>ThinkPlus™.22 2-year LOR²⁴ 9x5 NBD 41C9175</p> <p>ThinkPlus 3-year LOR 9x5 NBD 41C9176</p> <p>ThinkPlus 4-year LOR 9x5 NBD 41C9177</p> <p>ThinkPlus 5-year LOR 9x5 NBD 41C9179</p> <p>ThinkPlus 4-year P&L P/U Depot 41C9178</p> <p>ThinkPlus 5-year P&L P/U Depot 41C9180</p> <p>Post-warranty annual maintenance agreements at lenovo.com/thinkplus/warranty</p>															

See footnotes for important warranty information
 US model announced February 19, 2008

* Intel Centrino® processor technology

© Lenovo
 (LAG2-4) February 2008

Partial list of accessories supported on:

- ThinkPad R61 14W originally announced on May 9, 2007

Memory

512MB PC2-5300 DDR2 SODIMM	40Y7733	ann 01/05/06
1GB PC2-5300 DDR2 SODIMM (TopSeller)	43R1999	ann 03/25/08
1GB PC2-5300 DDR2 SODIMM	40Y7734	ann 01/05/06
2GB PC2-5300 DDR2 SODIMM (TopSeller)	43R2000	ann 03/25/08
2GB PC2-5300 DDR2 SODIMM	40Y7735	ann 11/28/06

Ultrabay Slim 9.5mm (supports both flat and curved bezel options)
 Serial Hard Drive Ultrabay Slim Adapter (flat)⁴⁸ 40Y8725 ann 09/20/05
 ThinkPad DVD Ultrabay Slim Burner (flat)⁴⁸ 41N5643 ann 05/31/07
⁴⁸ Slim 9.5mm device in 12.7mm bay shows gap above the device.

Ultrabay Enhanced 12.7mm (supports both flat and curved bezel)
 CD-RW/DVD Combo Ultrabay Enhanced (cur) 73P3275 ann 10/07/03

Storage and removable storage

160GB Disk SATA 1.5Gb/s (5400 rpm) ⁴¹	41N5692	ann 03/20/07
160GB Disk SATA 1.5Gb/s (7200 rpm) ⁴¹	41N5737	ann 10/16/07
200GB Disk FDE SATA 1.5Gb/s (7200 rpm) ⁴¹	41N5738	ann 10/16/07
250GB Disk SATA 1.5Gb/s (5400 rpm) ⁴¹	43R8152	ann 01/15/08
320GB Disk SATA 1.5Gb/s (5400 rpm) ⁴¹	43N3403	ann 08/05/08

⁴¹ Can be used as the main HDD or with ThinkPad

Serial ATA Hard Drive Ultrabay Slim Adapter 40Y8725

in the Ultrabay or in the ThinkPad Advanced Dock 250310U.

USB 2.0 Essential Memory Key 4GB	45J7904	ann 06/24/08
USB 2.0 Essential Memory Key 8GB	45J7905	ann 07/15/08
USB 2.0 Essential Memory Key 32GB	45K1258	ann 10/28/08
USB 2.0 Security Memory Key 2GB	41U5119	ann 07/17/07
USB 2.0 Security Memory Key 4GB	41U5120	ann 07/17/07
USB 2.0 Ultra Secure Memory Key 2GB	45J5916	ann 08/26/08
USB 2.0 Ultra Secure Memory Key 4GB	45J5917	ann 08/26/08
USB 2.0 Ultra Secure Memory Key 8GB	45J5918	ann 08/26/08

USB Portable Diskette Drive	05K9276	ann 06/05/00
USB 2.0 CD-RW/DVD-ROM Combo II Drive	40Y8637	ann 01/05/06
USB 2.0 Portable 160GB Hard Disk	43R1784	ann 09/23/08
USB 2.0 Portable Secure 160GB Hard Disk	43R2018	ann 11/18/08
USB 2.0 Portable Secure 320GB Hard Disk	43R2019	ann 11/18/08
USB 2.0 Super Multi-Burner Drive	41N5565	ann 01/23/07

ThinkPad Expansion

USB 2.0 Lenovo Enhanced Port Replicator	43R8770	ann 02/26/08
ThinkPad Adjustable Notebook Stand	40Y7676	ann 09/20/05
ThinkPad Essential Port Replicator	250510W	ann 09/20/05
ThinkPad Advanced Mini Dock	250410U	ann 09/20/05
ThinkPad Advanced Dock	250310U	ann 09/20/05

Keyboard

TrackPoint Cap Collection	73P2698	ann 12/16/03
USB Numeric Keypad	33L3225	ann 05/01/00
Preferred Pro USB Keyboard	73P5220	ann 06/21/05
Enhanced Performance USB Keyboard	73P2620	ann 03/23/04
Wireless Kybd & Opt Wheel Mouse (via USB)	73P4067	ann 12/07/04
USB Keyboard with UltraNav	31P8950	ann 01/28/03
USB Travel Keyboard with UltraNav	31P9490	ann 04/27/04
Lenovo USB Fingerprint Keyboard	73P4730	ann 02/22/05

Mouse

Optical Wheel Mouse (USB)	06P4069	ann 05/21/03
Optical ScrollPoint® Mouse (USB, PS/2)	31P7405	ann 08/27/02
Optical Wheel Travel Mouse (USB, PS/2)	31P7410	ann 06/04/02
Laser Tilt Wheel Mouse (USB, PS/2)	41U3074	ann 01/23/07
Lenovo Wireless Laser Mouse (blk, via USB)	45K1696	ann 11/25/08
Lenovo Wireless Laser Mouse (red, via USB)	51J0198	ann 11/25/08
Laser Tilt Wheel Travel Mouse (Bluetooth)	41U5008	ann 01/22/08
Wireless Kybd & Opt Wheel Mouse (via USB)	73P4067	ann 12/07/04

Security

Kensington® Cable Lock from Lenovo	73P2582	ann 12/29/03
Kensington Twin Head Cable Lock	45K1620	ann 09/30/08
USB Gemplus GemPC Smart Card Reader	41N3040	ann 02/21/06
PC Card Gemplus Smart Card Reader	41N3004	ann 12/13/05
ExpressCard Gemplus Smart Card Reader	41N3043	ann 06/27/06

Multimedia

USB 2.0 Lenovo Multimedia Headset	40Y8518	ann 06/27/06
USB 2.0 Lenovo Webcam	40Y8519	ann 08/29/06

Batteries

T/R 14W Standard Battery 4-cell	41U3196	ann 05/09/07
T/R 14W Enhanced Battery 6-cell	41U3198	ann 05/09/07
T/R 14W High Capacity Battery 9-cell	43R2499	ann 03/04/08
Advanced Ultrabay Battery II 3-cell ⁴³	43R9250	ann 04/22/08

⁴³ Used in Ultrabay Slim bay.

ThinkPad External Battery Charger⁴⁴ 40Y7625 ann 09/20/05

⁴⁴ Requires the ThinkPad 90W AC Adapter

40Y7659 (adapter provided with some systems).

ThinkPad 65W AC Adapter⁴⁵ 40Y7696 ann 01/05/06

⁴⁵ Only compatible with the 945GM and GM965 chipset models.

ThinkPad 90W AC Adapter 40Y7659 ann 09/20/05

ThinkPad 90W Slim AC/DC Combo Adapter 41N8460 ann 11/27/07

Charging tips for 90W Slim AC/DC Combo Adapter 41N8460

•Dual (ThinkPad+Phone) Charging Y-Cable 41R4345 ann 12/18/07

•BlackBerry charge tip (L8a) 41R4478 ann 12/18/07

•iPod and iPhone charge tip (L10a) 41R4481 ann 12/18/07

Carrying Cases

Up to 14.1" widescreen models:

ThinkPad Expander Case	43R9118	ann 06/24/08
ThinkPad Women's Microfiber Tote	22P8855	
ThinkPad Women's Leather Trim Tote	22P8856	
ThinkPad Convertible Carrying Case	22P8860	
ThinkPad Women's Executive Leather Tote	22P8857	
Women's Executive Red Leather Tote	22P8858	

Up to 15.4" widescreen models:

Lenovo Carrying Case - Messenger Max	41U5253	ann 05/01/07
Lenovo Carr Case - Performance Backpack	41U5254	ann 05/01/07
Lenovo Standard Case	45K1697	ann 11/25/08
Lenovo Standard Backpack	45K1698	ann 11/25/08
ThinkPad Business Topload Case	43R2476	ann 05/13/08
ThinkPad Business Backpack	43R2482	ann 05/13/08
ThinkPad Deluxe Expander Case	43R2478	ann 05/13/08
ThinkPad Executive Leather Case	43R2480	ann 05/13/08

Up to 17.0" widescreen models:

ThinkPad 17W Business Topload Case	43R9117	ann 08/12/08
------------------------------------	---------	--------------

Monitors

ThinkVision® L174 17" Monitor	9227AE1	ann 04/15/08
ThinkVision L1700p 17" Monitor	9417HE2	ann 09/17/08
ThinkVision L1900p 19" Monitor	4431HE1	ann 11/11/08
ThinkVision L1940p Wide 19" Monitor	4424HB6	ann 09/17/08
ThinkVision L200p Wide 20.1" Monitor	4438HB6	ann 04/15/08
ThinkVision L2240p Wide 22" Monitor	4422HB6	ann 09/17/08
ThinkVision L2440p Wide 24" Monitor	4420HB2	ann 09/17/08
ThinkVision L2440x Wide 24" Monitor	4421HB2	ann 09/17/08

Monitor Accessories⁴⁶

ThinkVision USB Soundbar	40Y7616	ann 08/23/05
ThinkVision Soundbar	45K1263	ann 09/16/08
Kensington Cable Lock from Lenovo	73P2582	ann 12/29/03
Kensington Twin Head Cable Lock	45K1620	ann 09/30/08
ThinkPad Convertible Monitor Stand	40Y7620	ann 01/05/06
Radial Arm	19K4464	ann 05/05/00

⁴⁶ Compatible on selected Lenovo and ThinkVision monitors.

More information at www.lenovo.com/support/monitoraccessories

Other accessories at www.lenovo.com/accessories

Accessories Guide pdf at www.lenovo.com/accessoriesguide

ThinkPad® R61 15W 8934 (GMA) - 3-year (TopSeller)

Personal Systems Reference (PSREF)

Type-model	Processor	GHz	Memory	Wide-screen display	Cam-era	Graphics controller	Disk SATA GB ⁶ rpm	EIDE optical	Mini PCIe 802.11 wireless	Card slot	Finger print reader	Blue-tooth	Bat-tery cells	Preload	Workhorse (W) Global (G) Educ	Avail date
8934-A7U T7100	1.80	1GB	15.4" WXGA	GMA	120G	5400	DVD±RW	*Intel 11a/b/g ³²	/54	Fing	6	XP Pro	Jul 07			
8934-BTU T7250	2.00	1GB	15.4" WXGA	GMA	160G	5400	DVD±RW	*Intel 11a/b/g	/54	Fing	6	Bus 32	Sep 07			
8934-F9U T8100	2.10	1GB	15.4" WXGA	GMA	160G	5400	DVD±RW	*Intel 11a/b/g	/54	Fing	6	XP Pro	Jan 08			
8934-FAU T8300	2.40	1GB	15.4" WXGA	GMA	160G	5400	DVD±RW	*Intel 11a/b/g	/54	Fing	6	Bus 32	Jan 08			
8934-01U T8100	2.10	2GB	15.4" WXGA	GMA	160G	5400	DVD±RW	*Intel 11a/b/g	/54	Fing	6	Bus 32	Educ	May 08		
8934-02U Celeron 550	2.00	1GB	15.4" WSXGA+	Cam	GMA	80G	5400	DVD±RW	Intel 4965AG ³²	4-in-1	Fing	Blue	6	Bus 32	Educ	Aug 08

• These small and medium business (SMB) models are part of the US TopSeller™ Program
 • These models have a 3-year limited warranty¹²

Positioning Processor	Everyday computing; two spindles Intel® Celeron® Processor 550 with single-core, 533MHz system bus, and 1MB L2 cache or Intel Core™ 2 Duo processor T7100, T7250, T8100, or T8300 with dual-core, 800MHz system bus, T7100/T7250: 2MB L2 cache; T8100/T8300: 3MB L2 cache	Preloaded operating system ²⁰ - Some: Microsoft® Windows® XP Professional with Vista® COA - Some: Microsoft Windows Vista Business Edition (32-bit) ◇ Vista models: Vista Basic logo
Memory	1GB or 2GB std / 4GB max ⁷ / PC2-5300 667MHz DDR2, non-parity, dual-channel capable, two 200-pin SO-DIMM sockets; <i>Italics:</i> standard memory in both sockets; no sockets available; <i>Non-italics:</i> standard memory in one socket; one socket available	Preloaded applications ¹⁴ (all OSes) • Some: Education software - Microsoft Office OneNote® 2007 (and CD) - VitalSource Library College Edition - Adobe® Instructor Resource Cntr - Adobe Digital School Collection – Photoshop Elements (and CD) – Premier Elements (and DVD) – Acrobat 8 Professional – Contribute 4 • Rescue and Recovery™ • Access Connections™ • Client Security Solution™ • ThinkVantage Productivity Center • ThinkVantage System Update • System Migration Assistant • Norton Internet Security™ (90 days of virus definitions) • Diskeeper® Home • PC-Doctor™ (diagnostics) • ThinkPad Utilities (Power Manager and Presentation Director) • Adobe Reader • Windows Live™ Toolbar • Windows Live Search • Picasa from Google • Fingerprint Software (fingerprint models) • Multimedia Center for Think Offerings (XP Pro) • Microsoft Office 2007 Trial (60-day) • Sonic RecordNOW and Drive Letter Access (DVD±RW) • Corel® WinDVD® (DVD±RW) • Corel WinDVD Creator (XP Pro DVD±RW models)
Diskette drive	None (use optional USB-based diskette drive)	
EIDE DVD±RW	DVD burner, Super Multi-Burner (40Y8624) dual-layer, removable Ultrabay™ Enhanced	
Ultrabay Enhanced	One bay for removable devices, Ultrabay Slim-compatible, 12.7mm high	
Serial ATA disk	80GB ⁸ (5400 rpm), 120GB (5400 rpm) or 160GB (5400 rpm) / SATA 1.5Gb/s, 9.5mm high, removable, upgradable, 9.5mm high bay, supports 2nd disk, ThinkPad Shock Mounted Hard Drive, Active Protection System™	
Widescreen display	Some: 15.4" (391mm) WXGA (1280x800) color, anti-glare, 200 nits, 16:10 aspect ratio, 300:1 contrast ratio Some: 15.4" (391mm) WSXGA+ (1680x1050) color, anti-glare, 200 nits, 16:10 aspect ratio, 500:1 contrast ratio	
Camera	Some: camera on top of screen, 1.3-megapixel, fixed focus, USB 2.0	
Graphics	Intel Graphics Media Accelerator X3100 (GMA X3100), integrated in GM965, no DVI pass-through support to optional Advanced Mini Dock or Advanced Dock	
Keyboard	89-key, ThinkVantage button, spill-resistant, multimedia Fn keys, Windows/Appl keys	
TrackPoint®	TrackPoint® pointing device, "Press-to-Select," Internet Scroll Bar ¹³ , magnifying glass	
Touch pad	UltraNav™ multi-pointing system, touch pad below keyboard, Tap Zones	
ThinkLight™	Illuminates the keyboard to improve visibility in low-light conditions	
Dimensions ³	6-cell 15.4W" (WxDxH): 14.1" x 10.2" x 1.39–1.52"; 358.5 x 260.0mm x 35.3–38.5mm	
Weight ²	6-cell: starting at 6.4 lb (2.9kg); 9-cell: starting at 6.7 lb (3.1kg)	
Case material	Black color, Polycarbonate/Acrylonitrile-Butadiene-Styrene (PC/ABS) plastic	
Battery - type	Lithium Ion 6-cell, supports unique 2nd battery in Ultrabay Enhanced	
Battery - life ¹⁰	6-cell: up to 5.0 hr; 9-cell: up to 7.0 hr; 6-cell plus Ultrabay battery: up to 8.5 hr	
Chipset	Mobile Intel GM965 Express Chipset (Graphics Memory Controller Hub); ICH8M I/O Controller Hub (SATA 3.0Gb/s, ATA-100 EIDE, PCI Express® x1, PCI bus, USB, LPC bus, [Bluetooth], [fingerprint]) / PCI bus (Ricoh® R5C847 Cardbus/1394/Multicard) / LPC bus (WPCN385 Super I/O, Atmel® 97SC3203 TPM)	
PC Card Std slot	One Type I or Type II slot, CardBus 32-bit	
ExpressCard slot	Some: [/54] One ExpressCard/34 or ExpressCard/54	
Smart Card Read	None	
Multicard Reader	Some: 4-in-1 reader (MultiMediaCard, Mem Stick® PRO, Sec Digital, xD-Picture Card™)	
Ports	Three USB 2.0, DB-15 (external VGA monitor), RJ-11 (modem), RJ-45 (ethernet), IEEE 1394 FireWire 400 (4-pin connector; 1394a-2000 standard), S-Video out	
Wireless antenna	UltraConnect™ II antenna / on-off switch for all wireless radios	Supports ThinkVantage® technologies
Mini PCI Express	One Mini PCI Express slot / 802.11 wireless is customer upgradable	65-watt (GMA graphics) ThinkPad Roll Cage (one-piece magnesium frame) ENERGY STAR® 4.0-compliant RoHS-compliant International Warranty Service ¹⁷ 24 hour x 7 day ¹⁸ toll-free support during the warranty period ¹² via 800-426-7378
Intel 11a/b/g ³²	Some: 11a/b/g wireless ⁴ , Mini PCIe adapter, Intel PRO/Wireless 3945ABG	
Intel 4965AG ³²	Some: 11a/b/g wireless ⁴ , Mini PCIe adapter, Intel Wireless WiFi Link 4965AG	
WWAN	None	
Turbo Memory	None	
Modem	56K V.92 ⁶ modem, on systemboard, Conexant® CX20548	
Bluetooth™	Some: Bluetooth 2.0 wireless, USB 2.0 interface via ICH8M, LED indicator	
Ethernet	Gigabit ethernet, Broadcom® BCM5787M (MAC/PHY), PCIe x1, PXE	
Intel AMT	None	
Audio support	High Definition (HD) Audio, CX20549 codec / stereo speakers, 1 watt / volume up, down, mute buttons / internal microphone, microphone input jack, headphone jack	ThinkPlus™.22 2-year LOR ²⁴ 9x5 NBD 41C9175
Security	Power-on password, hard disk password, supervisor password, security keyhole	ThinkPlus 3-year LOR 9x5 NBD 41C9176
Security chip	Trusted Platform Module, Atmel chip, TCG 1.2-compliant	ThinkPlus 4-year LOR 9x5 NBD 41C9177
Fingerprint reader	Fingerprint reader on palm rest, swipe sensor, supported with security chip	ThinkPlus 5-year LOR 9x5 NBD 41C9179
Limited warranty ¹²	3-years/1-yr battery - EasyServ™.19 depot repair service / service upgrades ²² available	ThinkPlus 4-year P&L P/U Depot 41C9178
1GB PC2-5300 DDR2 SODIMM (TopSeller)	43R1999	T/R/W/SL Series Li-Ion Battery 6-cell 40Y6799
2GB PC2-5300 DDR2 SODIMM (TopSeller)	43R2000	T/R/W/SL Series Li-Ion Battery 9-cell 40Y6797
Serial Hard Drive Ultrabay Slim Adapter (flat)	40Y8725	Advanced Ultrabay Battery II 3-cell 43R9250
320GB Disk SATA 1.5Gb/s (5400 rpm)	43N3403	90W Slim AC/DC Combo Adapter 41N8460
USB 2.0 Lenovo Enhanced Port Replicator	43R8770	ThinkPad Business Topload Case 43R2476
ThinkPad Advanced Mini Dock	250410U	ThinkVision® L2240p Wide 22" Monitor 4422HB6
ThinkPad Advanced Dock	250310U	ThinkVision L2440x Wide 24" Monitor 4421HB2
Other accessories on O-R61-15W sheet		Other accessories at lenovo.com/accessories

See footnotes for important warranty information

* Intel Centrino® processor technology

© Lenovo

Ⓜ US model announced August 1, 2008; previous models on July 10, Sep 18, 2007, Jan 8, or May 9, 2008

(WKK11-2) August 2008

Ⓜ US model withdrawn effective December 2007

ThinkPad® R61u 15W 8933 (GMA) - Education (EasyServ)

Personal Systems Reference (PSREF)

Type-model	Processor	GHz	Memory	Wide-screen display	Camera	Graphics controller	Disk SATA GB ³	EIDE rpm	EIDE optical	Mini PCIe 802.11 wireless	Card slot	Finger print reader	Blue-tooth	Battery cells	Workhorse (W) Global (G)	Avail date
8933-ESU	T8100	2.10	1GB	15.4" WXGA	Cam	GMA	80G	5400	Combo	11a/b/g	/54	Finger	Blue	6	Business32	No Jan 08
8933-ETU	T8300	2.40	1GB	15.4" WSXGA+	Cam	GMA	100G	7200	Combo	11a/b/g	/54	Finger	Blue	6	Business32	No Jan 08

• **These models have an EasyServ™,19 depot repair service 3-year limited warranty**

Educational models are available only to public or private K-12 or higher accredited schools organized and operated exclusively for educational purposes for use by qualified students and teachers.

Positioning Processor	<i>Everyday computing; two spindles</i> Intel® Core™ 2 Duo processor T8100 or T8300 with dual-core, Intel 64 Technology, Enhanced Intel SpeedStep® technology ¹ , Intel Dynamic Acceleration, Execute Disable Bit, Virtualization Technology, 800MHz system bus, and 3MB shared L2 cache											Preloaded operating system²⁰ - Microsoft® Windows® Vista® Business Edition (32-bit) ↳ Vista Basic logo				
Memory	1GB std / 4GB max ⁷ / PC2-5300 667MHz DDR2, non-parity, dual-channel capable, two 200-pin SO-DIMM sockets; <i>Non-italics:</i> standard memory in one socket; one socket available											Preloaded applications¹⁴ • Education software - VitalSource Library College Edition - Adobe® Instructor Resource Cntr - Adobe Digital School Collection - Photoshop Elements (and CD) - Premier Elements (and DVD) - Acrobat 8 Professional - Contribute 4 • Rescue and Recovery™ • Access Connections™ • Client Security Solution™ • ThinkVantage Productivity Center • ThinkVantage System Update • System Migration Assistant • Norton Internet Security™ (90 days of virus definitions) • Diskeeper® Home • PC-Doctor™ (diagnostics) • ThinkPad Utilities (Power Manager and Presentation Director) • Adobe Reader • Windows Live™ Toolbar • Windows Live Search • Picasa from Google • <i>Some:</i> Fingerprint Software • Microsoft Office 2007 Trial (60-day) • Sonic RecordNow and Drive Letter Access (Combo) • Corel® WinDVD® (Combo)				
Diskette drive	None (use optional USB-based diskette drive)															
EIDE Combo	DVD-ROM/CD-RW (73P3288), 24X/24X/24X/8X21, removable Ultrabay™ Enh, curved															
Ultrabay Enhanced	One bay for removable devices, Ultrabay Slim-compatible, 12.7mm high															
Serial ATA disk	80GB⁸ (5400 rpm) or 100GB (7200 rpm) / SATA 1.5Gb/s, 9.5mm high, removable, upgradable, 9.5mm high bay, supports 2nd disk, ThinkPad Shock Mounted Hard Drive, Active Protection System™															
Widescreen display	<i>Some:</i> 15.4" (391mm) WXGA (1280x800) color , anti-glare, 200 nits, 16:10, 300:1 <i>Some:</i> 15.4" (391mm) WSXGA+ (1680x1050) color , anti-glare, 200 nits, 16:10, 300:1															
Camera	Camera on top of screen, 1.3-megapixel, fixed focus, USB 2.0															
Graphics	Intel Graphics Media Accelerator X3100 (GMA X3100) , integrated in GM965, no DVI pass-through support to optional Advanced Mini Dock or Advanced Dock															
Keyboard	89-key, ThinkVantage button, spill-resistant, multimedia Fn keys, Windows/Apply keys															
TrackPoint®	TrackPoint® pointing device, "Press-to-Select," Internet Scroll Bar ¹³ , magnifying glass															
Touch pad	UltraNav™ multi-pointing system, touch pad below keyboard, Tap Zones															
ThinkLight™	Illuminates the keyboard to improve visibility in low-light conditions															
Dimensions ³	<i>6-cell 15.4W"</i> (WxDxH): 14.1" x 10.2" x 1.39–1.52"; 358.5 x 260.0mm x 35.3–38.5mm															
Weight ²	<i>6-cell:</i> starting at 6.4 lb (2.9kg); <i>9-cell:</i> starting at 6.7 lb (3.1kg)															
Case material	Black color, Polycarbonate/Acrylonitrile-Butadiene-Styrene (PC/ABS) plastic															
Battery - type	Lithium Ion 6-cell , supports unique 2nd battery in Ultrabay Enhanced															
Battery - life ¹⁰	<i>6-cell:</i> up to 5.0 hr; <i>9-cell:</i> up to 7.0 hr; <i>6-cell plus Ultrabay battery:</i> up to 8.5 hr															
Chipset	Mobile Intel GM965 Express Chipset (Graphics Memory Controller Hub); ICH8M I/O Controller Hub (SATA 3.0Gb/s, ATA-100 EIDE, PCI Express® x1, PCI bus, USB, LPC bus, [Bluetooth], [fingerprint]) / PCI bus (Ricoh® R5C847 Cardbus/1394/Multicard) / LPC bus (WPCN385 Super I/O, Atmel® 97SC3203 TPM)															
PC Card Std slot	One Type I or Type II slot, CardBus 32-bit															
ExpressCard slot	[54] One ExpressCard/34 or ExpressCard/54															
Smart Card Reader	None															
Multicard Reader	4-in-1 reader (MultiMediaCard, Memory Stick® PRO™, Secure Digital, xD-Picture Card™)															
Ports	Three USB 2.0, DB-15 (external VGA monitor), RJ-11 (modem), RJ-45 (ethernet), IEEE 1394 FireWire 400 (4-pin connector; 1394a-2000 standard), S-Video out															
Wireless antenna	UltraConnect™ II antenna / on-off switch for all wireless radios															
Mini PCI Express	One Mini PCI Express slot / 802.11 wireless is customer upgradable															
Intel 11a/b/g ³²	11a/b/g wireless ⁴ , ThinkPad 11a/b/g Mini PCIe Adapter, Atheros AR5006EX															
WWAN	None															
Turbo Memory	None															
Modem	56K V.92 ⁶ modem, on systemboard, Conexant® CX20548															
Bluetooth™	<i>Some:</i> Bluetooth 2.0 wireless, USB 2.0 interface via ICH8M, LED indicator															
Ethernet	Gigabit ethernet, Broadcom® BCM5787M (MAC/PHY), PCIe x1, PXE															
Intel AMT	None															
Audio support	High Definition (HD) Audio, CX20549 codec / stereo speakers, 1 watt / volume up, down, mute buttons / internal microphone, microphone input jack, headphone jack															
Security	Power-on password, hard disk password, supervisor password, security keyhole															
Security chip	Trusted Platform Module , Atmel chip, TCG 1.2-compliant															
Fingerprint reader	<i>Some:</i> Fingerprint reader on palm rest , swipe sensor, supported with security chip															
Limited warranty ¹²	3-years/1-yr battery - EasyServ™,19 depot repair service / service upgrades²² available											ThinkPlus™,22 2-year LOR ²⁴ 9x5 NBD 41C9175				
1GB PC2-5300 DDR2 SODIMM	40Y7734			T/R/W/SL Series Li-Ion Battery 6-cell				40Y6799				ThinkPlus 3-year LOR 9x5 NBD 41C9176				
2GB PC2-5300 DDR2 SODIMM	40Y7735			T/R/W/SL Series Li-Ion Battery 9-cell				40Y6797				ThinkPlus 4-year LOR 9x5 NBD 41C9177				
Serial Hard Drive Ultrabay Slim Adapter (flat)	40Y8725			Advanced Ultrabay Battery II 3-cell				43R9250				ThinkPlus 5-year LOR 9x5 NBD 41C9179				
ThinkPad DVD Ultrabay Slim Burner (flat)	41N5643			ThinkPad External Battery Charger				40Y7625				ThinkPlus 4-year P&L P/U Depot 41C9178				
200GB Disk FDE SATA 1.5Gb/s (7200 rpm)	41N5738			ThinkPad 90W AC Adapter				40Y7659				ThinkPlus 5-year P&L P/U Depot 41C9180				
320GB Disk SATA 1.5Gb/s (5400 rpm)	43N3403			90W Slim AC/DC Combo Adapter				41N8460				Post-warranty annual maintenance agreements at lenovo.com/thinkplus/warranty				
USB 2.0 Ultra Secure Memory Key 8GB	45J5918			ThinkPad Business Topload Case				43R2476								
USB 2.0 Super Multi-Burner Drive	41N5565			ThinkPad Business Backpack				43R2482								
ThinkPad Convertible Monitor Stand	40Y7620			ThinkPad Deluxe Expander Case				43R2478								
ThinkPad Essential Port Replicator	250510W			ThinkVision® L1940p Wide 19" Monitor				4424HB6								
ThinkPad Advanced Mini Dock	250410U			ThinkVision L2240p Wide 22" Monitor				4422HB6								
ThinkPad Advanced Dock	250310U			ThinkVision L2440p Wide 24" Monitor				4420HB2								
Other accessories on O-R61-15W sheet	Other accessories at lenovo.com/accessories															

See footnotes for important warranty information
US models announced February 19, 2008

© Lenovo
(WKK2-1) February 2008

Partial list of accessories supported on:**• ThinkPad R61 15W originally announced on May 31, 2007****Memory**

512MB PC2-5300 DDR2 SODIMM	40Y7733	ann 01/05/06
1GB PC2-5300 DDR2 SODIMM (TopSeller)	43R1999	ann 03/25/08
1GB PC2-5300 DDR2 SODIMM	40Y7734	ann 01/05/06
2GB PC2-5300 DDR2 SODIMM (TopSeller)	43R2000	ann 03/25/08
2GB PC2-5300 DDR2 SODIMM	40Y7735	ann 11/28/06

Ultrabay Slim 9.5mm (supports both flat and curved bezel options)
 Serial Hard Drive Ultrabay Slim Adapter (flat)⁴⁸ 40Y8725 ann 09/20/05
 ThinkPad DVD Ultrabay Slim Burner (flat)⁴⁸ 41N5643 ann 05/31/07
⁴⁸ Slim 9.5mm device in 12.7mm bay shows gap above the device.

Ultrabay Enhanced 12.7mm (supports both flat and curved bezel)
 CD-RW/DVD Combo Ultrabay Enhanced (cur) 73P3275 ann 10/07/03

Storage and removable storage

160GB Disk SATA 1.5Gb/s (5400 rpm) ⁴¹	41N5692	ann 03/20/07
160GB Disk SATA 1.5Gb/s (7200 rpm) ⁴¹	41N5737	ann 10/16/07
200GB Disk FDE SATA 1.5Gb/s (7200 rpm) ⁴¹	41N5738	ann 10/16/07
250GB Disk SATA 1.5Gb/s (5400 rpm) ⁴¹	43R8152	ann 01/15/08
320GB Disk SATA 1.5Gb/s (5400 rpm) ⁴¹	43N3403	ann 08/05/08

⁴¹ Can be used as the main HDD or with ThinkPad

Serial ATA Hard Drive Ultrabay Slim Adapter 40Y8725
 in the Ultrabay or in the ThinkPad Advanced Dock 250310U.

USB 2.0 Essential Memory Key 2GB	41U4944	ann 01/23/07
USB 2.0 Essential Memory Key 4GB	45J7904	ann 06/24/08
USB 2.0 Essential Memory Key 8GB	45J7905	ann 07/15/08
USB 2.0 Essential Memory Key 32GB	45K1258	ann 10/28/08
USB 2.0 Security Memory Key 2GB	41U5119	ann 07/17/07
USB 2.0 Security Memory Key 4GB	41U5120	ann 07/17/07
USB 2.0 Ultra Secure Memory Key 2GB	45J5916	ann 08/26/08
USB 2.0 Ultra Secure Memory Key 4GB	45J5917	ann 08/26/08
USB 2.0 Ultra Secure Memory Key 8GB	45J5918	ann 08/26/08

USB Portable Diskette Drive	05K9276	ann 06/05/00
USB 2.0 CD-RW/DVD-ROM Combo II Drive	40Y8637	ann 01/05/06
USB 2.0 Portable 160GB Hard Disk	43R1784	ann 09/23/08
USB 2.0 Portable Secure 160GB Hard Disk	43R2018	ann 11/18/08
USB 2.0 Portable Secure 320GB Hard Disk	43R2019	ann 11/18/08
USB 2.0 Super Multi-Burner Drive	41N5565	ann 01/23/07

ThinkPad Expansion

USB 2.0 Lenovo Enhanced Port Replicator	43R8770	ann 02/26/08
ThinkPad Adjustable Notebook Stand	40Y7676	ann 09/20/05
ThinkPad Essential Port Replicator	250510W	ann 09/20/05
ThinkPad Advanced Mini Dock	250410U	ann 09/20/05
ThinkPad Advanced Dock	250310U	ann 09/20/05

Keyboard

TrackPoint Cap Collection	73P2698	ann 12/16/03
USB Numeric Keypad	33L3225	ann 05/01/00
Preferred Pro USB Keyboard	73P5220	ann 06/21/05
Enhanced Performance USB Keyboard	73P2620	ann 03/23/04
Wireless Kybd & Opt Wheel Mouse (via USB)	73P4067	ann 12/07/04
USB Keyboard with UltraNav	31P8950	ann 01/28/03
USB Travel Keyboard with UltraNav	31P9490	ann 04/27/04
Lenovo USB Fingerprint Keyboard	73P4730	ann 02/22/05

Mouse

Optical Wheel Mouse (USB)	06P4069	ann 05/21/03
Optical ScrollPoint® Mouse (USB, PS/2)	31P7405	ann 08/27/02
Optical Wheel Travel Mouse (USB, PS/2)	31P7410	ann 06/04/02
Laser Tilt Wheel Mouse (USB, PS/2)	41U3074	ann 01/23/07
Lenovo Wireless Laser Mouse (blk, via USB)	45K1696	ann 11/25/08
Lenovo Wireless Laser Mouse (red, via USB)	51J0198	ann 11/25/08
Laser Tilt Wheel Travel Mouse (Bluetooth)	41U5008	ann 01/22/08

Security

Kensington® Cable Lock from Lenovo	73P2582	ann 12/29/03
Kensington Twin Head Cable Lock	45K1620	ann 09/30/08
USB Gemplus GemPC Smart Card Reader	41N3040	ann 02/21/06
PC Card Gemplus Smart Card Reader	41N3004	ann 12/13/05
ExpressCard Gemplus Smart Card Reader	41N3043	ann 06/27/06

Multimedia

USB 2.0 Lenovo Multimedia Headset	40Y8518	ann 06/27/06
USB 2.0 Lenovo Webcam	40Y8519	ann 08/29/06

Batteries

T/R/W/SL Series Li-Ion Battery 6-cell	40Y6799	ann 01/05/06
T/R/W/SL Series Li-Ion Battery 9-cell	40Y6797	ann 09/20/05
Advanced Ultrabay Battery II 3-cell ⁴³	43R9250	ann 04/22/08

⁴³ Used in Ultrabay Slim bay.

ThinkPad External Battery Charger⁴⁴ 40Y7625 ann 09/20/05

⁴⁴ Requires the ThinkPad 90W AC Adapter

40Y7659 (adapter provided with some systems).

ThinkPad 65W AC Adapter⁴⁵ 40Y7696 ann 01/05/06

⁴⁵ Only compatible with the 945GM and GM965 chipset models.

ThinkPad 90W AC Adapter 40Y7659 ann 09/20/05

ThinkPad 90W Slim AC/DC Combo Adapter 41N8460 ann 11/27/07

Charging tips for 90W Slim AC/DC Combo Adapter 41N8460

•Dual (ThinkPad+Phone) Charging Y-Cable	41R4345	ann 12/18/07
•Palm device charge tip (L7)	41R4315	ann 12/18/07
•BlackBerry charge tip (L8a)	41R4478	ann 12/18/07
•iPod and iPhone charge tip (L10a)	41R4481	ann 12/18/07

Carrying Cases

Up to 15.4" widescreen models:

Lenovo Carrying Case - Messenger Max	41U5253	ann 05/01/07
Lenovo Carr Case - Performance BackPack	41U5254	ann 05/01/07
Lenovo Standard Case	45K1697	ann 11/25/08
Lenovo Standard Backpack	45K1698	ann 11/25/08
ThinkPad Business Topload Case	43R2476	ann 05/13/08
ThinkPad Business Backpack	43R2482	ann 05/13/08
ThinkPad Deluxe Expander Case	43R2478	ann 05/13/08
ThinkPad Executive Leather Case	43R2480	ann 05/13/08

Up to 17.0" widescreen models:

ThinkPad 17W Business Topload Case	43R9117	ann 08/12/08
------------------------------------	---------	--------------

Monitors

ThinkVision® L174 17" Monitor	9227AE1	ann 04/15/08
ThinkVision L1700p 17" Monitor	9417HE2	ann 09/17/08
ThinkVision L1900p 19" Monitor	4431HE1	ann 11/11/08
ThinkVision L1940p Wide 19" Monitor	4424HB6	ann 09/17/08
ThinkVision L200p Wide 20.1" Monitor	4438HB6	ann 04/15/08
ThinkVision L2240p Wide 22" Monitor	4422HB6	ann 09/17/08
ThinkVision L2440p Wide 24" Monitor	4420HB2	ann 09/17/08
ThinkVision L2440x Wide 24" Monitor	4421HB2	ann 09/17/08

Monitor Accessories⁴⁶

ThinkVision USB Soundbar	40Y7616	ann 08/23/05
ThinkVision Soundbar	45K1263	ann 09/16/08
Kensington Cable Lock from Lenovo	73P2582	ann 12/29/03
Kensington Twin Head Cable Lock	45K1620	ann 09/30/08
ThinkPad Convertible Monitor Stand	40Y7620	ann 01/05/06
Radial Arm	19K4464	ann 05/05/00

⁴⁶ Compatible on selected Lenovo and ThinkVision monitors.

More information at www.lenovo.com/support/monitoraccessories

Other accessories at www.lenovo.com/accessories

Accessories Guide pdf at www.lenovo.com/accessoriesguide

ThinkPad® R61i 14W 7732 (GMA) - TopSeller (March 2008)

Personal Systems Reference (PSREF)

Type-model	Proc- essor	GHz	Memory	Wide- screen display	Screen type	Cam- era	Graphics controller	Disk SATA GB ⁸ rpm	EIDE optical	Mini PCIe 802.11 wireless	Card slot	Bat- tery 1394 port	Workhorse (W) Global (G) Educ	Avail date	
7732-2KU	T2370	1.73	1GB	14.1"	WXGA+		GMA	120G 5400	DVD±RW	Intel 11a/b/g	/54	1394 4	XP Pro	Mar 08	
7732-2LU	T2370	1.73	1GB	14.1"	WXGA		GMA	120G 5400	DVD±RW	Intel 11a/b/g	/54	1394 4	XP Pro	Mar 08	
7732-2MU	T5550	1.83	1GB	14.1"	WXGA		GMA	120G 5400	DVD±RW	*Intel 11a/b/g	/54	1394 4	XP Pro	Mar 08	
7732-B1U	T2390	1.86	1GB	14.1"	WXGA		GMA	160G 5400	DVD±RW	Intel 11a/b/g	/54	1394 4	Business 32	Apr 08	
7732-B2U	T2390	1.86	1GB	14.1"	WXGA	Glossy	Cam	GMA	160G 5400	DVD±RW	Intel 11a/b/g	/54	1394 4	Business 32	Apr 08
7732-B3U	T2390	1.86	1GB	14.1"	WXGA	Glossy	Cam	GMA	160G 5400	DVD±RW	Intel 11a/b/g	/54	1394 4	Home Prem	Apr 08
7732-B4U	T5750	2.00	1GB	14.1"	WXGA		GMA	160G 5400	DVD±RW	*Intel 11a/b/g	/54	1394 4	Business 32	Apr 08	
7732-B5U	T5750	2.00	1GB	14.1"	WXGA+		Cam	GMA	160G 5400	DVD±RW	*Intel 11a/b/g	/54	1394 4	Business 32	Apr 08
7732-01U	T8100	2.10	1GB	14.1"	WXGA		GMA	120G 5400	DVD±RW	*Intel 11a/b/g	4-in-1	1394 6	Business 32	Educ May 08	
7732-D1U	T2390	1.86	2GB	14.1"	WXGA		GMA	160G 5400	DVD±RW	Intel 11n ²⁸	/54	1394 4	XP Pro	Aug 08	

• These small and medium business (SMB) models are part of the US TopSeller™ Program

Processor	<p>Intel® Pentium® Dual-Core Processor T2370 or T2390 with dual-core, Intel 64 Technology, Enhanced Intel SpeedStep® technology¹, Execute Disable Bit, 533MHz system bus, and 1MB shared L2 cache or</p> <p>Intel Core™ 2 Duo processor T5550 or T5750 with dual-core, Intel 64 Technology, Enhanced Intel SpeedStep technology¹, Execute Disable Bit, 667MHz system bus, and 2MB shared L2 cache</p> <p>Intel Core 2 Duo processor T8100 with dual-core, Intel 64 Technology, Enhanced Intel SpeedStep® technology¹, Intel Dynamic Acceleration, Execute Disable Bit, Virtualization Technology, 800MHz system bus, and 3MB shared L2 cache</p>	<p>Preloaded operating system²⁰</p> <ul style="list-style-type: none"> - Some: Microsoft® Windows® XP Professional with Vista® COA - Some: Microsoft Windows Vista Business Edition (32-bit) - Some: Microsoft Windows Vista® Home Premium Ed (32-bit) <p>◇ D1U/Vista models: Vista Basic logo</p>
Memory	<p>1GB or 2GB std / 4GB max⁷ / PC2-5300 667MHz DDR2, non-parity, dual-channel capable, two 200-pin SO-DIMM sockets;</p> <p><i>Italics:</i> standard memory in both sockets; no sockets available;</p> <p><i>Non-italics:</i> standard memory in 1 socket; 1 socket available</p>	<p>Preloaded applications¹⁴ (all OSes; only some listed)</p> <ul style="list-style-type: none"> • Some: Education software - VitalSource Library College Edition - Adobe® Instructor Resource Cntr - Adobe Digital School Collection - Photoshop Elements (and CD) - Premier Elements (and DVD) - Acrobat 8 Professional - Contribute 4 • Lenovo CareSM for Think • Rescue and RecoveryTM • ThinkPad Utilities (Power Manager and Presentation Director) • Adobe® Reader • Multimedia Center for Think Offerings (XP Pro models) • Microsoft Office OneNote® 2007 and CD (01U model) • Microsoft Office 2007 Trial (60-day) • Network MagicTM • Corel® Small Business CenterTM with WordPerfect® Office 12 • QuickBooks Financial Center • Sonic RecordNow and Drive Letter Access (DVD±RW) • Corel WinDVD® (DVD±RW) • Corel WinDVD Creator (XP Pro DVD±RW models)
Diskette drive	None (use optional USB-based diskette drive)	
EIDE DVD±RW	DVD burner, Super Multi-Burner (40Y8624) dual-layer, removable Ultrabay™ Enhanced	
Ultrabay Enhanced	One bay for removable devices, Ultrabay Slim-compatible, 12.7mm high	
Serial ATA disk	<p>120GB⁸ (5400 rpm) or 160GB (5400 rpm) /</p> <p>SATA 1.5Gb/s, 9.5mm high, removable, upgradable, 9.5mm high bay, supports 2nd disk, ThinkPad Shock Mounted Hard Drive, Active Protection SystemTM</p>	
Widescreen display	<p><i>Some:</i> 14.1" (358.1mm) WXGA (1280x800) TFT color, anti-glare, 185 nits, 16:10 aspect ratio, 300:1 contrast ratio</p> <p><i>Some:</i> 14.1" (358.1mm) WXGA (1280x800) TFT color, VibrantView (glossy), 185 nits, 16:10 aspect ratio, 300:1 contrast ratio</p> <p><i>Some:</i> 14.1" (358.1mm) WXGA+ (1440x900) TFT color, anti-glare, 200 nits, 16:10 aspect ratio, 300:1 contrast ratio</p>	
Camera	<i>Some:</i> camera on top of screen, 1.3-megapixel, fixed focus, USB 2.0	
Graphics	Intel Graphics Media Accelerator X3100 (GMA X3100) , integrated in GM965, DVI pass-through support to optional Advanced Mini Dock or Advanced Dock	
Keyboard	89-key, ThinkVantage button, spill-resistant, multimedia Fn keys, Windows/Appl keys	
TrackPoint®	TrackPoint® pointing device, "Press-to-Select," Internet Scroll Bar ¹³ , magnifying glass	
Touch pad	UltraNav™ multi-pointing system, touch pad below keyboard, Tap Zones	
ThinkLight™	Illuminates the keyboard to improve visibility in low-light conditions	
Dimensions ³	4-cell 14.1W" (WxDxH): 13.2" x 9.3" x 1.2–1.37"; 335mm x 237mm x 30.6–34.9mm	
Weight ²	4-cell: starting at 5.2 lb (2.4kg)	
Case material	<i>Top:</i> Super-Elastic PolyCarbonate (SEPC); <i>Bottom:</i> Carbon-Fiber Reinforced Plastic	
Battery - type	Lithium Ion 4-cell or 6-cell , supports unique 2nd battery in Ultrabay Slim	
Battery - life ¹⁰	4-cell: up to 3.6 hr; <i>optional 6-cell:</i> up to 5.7 hr; 6-cell plus Ultrabay battery: up to 7.2 hr	
Chipset	Mobile Intel GM965 Express Chipset (Graphics Memory Controller Hub); ICH8M-Enhanced I/O Controller Hub (SATA 3.0Gb/s, ATA-100 EIDE, PCI Express® x1, PCI bus, USB, LPC bus, [Bluetooth], [fingerprint]) / PCI bus (Ricoh® R5C847 Cardbus/1394/Multicard) / LPC bus (WPCN385 Super I/O, Atmel® 97SC3203 TPM)	<p>Supports ThinkVantage® technologies</p> <p>65-watt (GMA graphics) AC adapter</p> <p>ThinkPad Roll Cage and Top Cover</p> <p>Roll Cage (one-piece magnesium)</p> <p>ENERGY STAR® 4.0-compliant</p> <p>RoHS-compliant</p> <p>International Warranty Service¹⁷</p> <p>24 hour x 7 day¹⁸ toll-free support during the warranty period¹²</p> <p>via 800-426-7378</p>
PC Card Std slot	One Type I or Type II slot, CardBus 32-bit	
ExpressCard slot	<i>Some:</i> [/54] One ExpressCard/34 or ExpressCard/54	
Smart Card Read	None	
Multicard Reader	<i>Some:</i> 4-in-1 reader (MultiMediaCard, Mem Stick® PRO, Sec Digital, xD-Picture Card™)	
Ports	Three USB 2.0, DB-15 (external VGA monitor), RJ-11 (modem), RJ-45 (ethernet), IEEE 1394 FireWire 400 (4-pin connector; 1394a-2000 standard)	
Wireless antenna	UltraConnect™ II antenna / on-off switch for all wireless radios	ThinkPlus™.22 1-year LOR ²⁴ 9x5 NBD
Mini PCI Express	Two Mini PCI Express slots / only 802.11 wireless is customer upgradable	41C9166
Intel 11a/b/g ³²	<i>Some:</i> 11a/b/g wireless ⁴ , Mini PCIe adapter, Intel PRO/Wireless 3945ABG	ThinkPlus 2-year LOR 9x5 NBD
Intel 11n ²⁸	<i>Some:</i> 11a/b/g/n wireless ⁴ , Mini PCIe adapter, Intel Wireless WiFi Link 4965AGN, MIMO 2x3 (Kedron)	41C9167
WWAN	None	ThinkPlus 3-year LOR 9x5 NBD
Turbo Memory	None	41C9168
Modem	56K V.92 ⁶ modem in Communications Daughter Card socket	ThinkPlus 4-year LOR 9x5 NBD
Bluetooth™	Bluetooth 2.0 wireless, USB 2.0 interface via ICH8M, LED indicator	41C9171
Ethernet	Gigabit ethernet, Intel 82566MM Nineveh (PHY), PCIe x1 (GLCI), PXE	ThinkPlus 5-year LOR 9x5 NBD
Intel AMT	None	41C9173
Audio support	High Definition (HD) Audio, AD1984HD codec / stereo speakers, 1 watt / volume up, down, mute buttons / internal microphone, microphone input jack, headphone jack	ThinkPlus 2-year P&L P/U Depot
Security	Power-on password, hard disk password, supervisor password, security keyhole	41C9169
Security chip	Trusted Platform Module , Atmel chip, TCG 1.2-compliant	ThinkPlus 3-year P&L P/U Depot
Fingerprint reader	Fingerprint reader on palm rest , swipe sensor, supports the security chip	41C9170
Limited warranty ¹²	1-year - EasyServ™.19 depot repair service / service upgrades ²² available	ThinkPlus 4-year P&L P/U Depot
		41C9172
		ThinkPlus 5-year P&L P/U Depot
		41C9174

See footnotes for important warranty information *Intel Centrino® processor technology
 7732 US model announced August 5, 2008; previous models on March 4, April 8, or May 12, 2008

ThinkPad® R61i 15W 7650 (GMA) - TopSeller

Personal Systems Reference (PSREF)

Type-model	Processor	GHz	Memory	Wide-screen display	Graphics controller	Disk SATA GB ⁵ rpm	EIDE optical	Mini PCIe 802.11 wireless	Finger print reader	Blue-tooth	Battery cells	Preload	Workhorse (W) Global (G) Educ	Avail date
7650-8CU	T5250	1.50	512MB	15.4" WXGA	GMA	80GB 5400	Combo	* Intel 11a/b/g ³²	None	None	6	XP Pro		July 07
7650-8DU	T5250	1.50	1GB	15.4" WXGA	GMA	80GB 5400	DVD±RW	* Intel 11a/b/g	None	None	6	XP Pro		July 07
7650-9LU	T2330	1.60	1GB	15.4" WXGA	GMA	80GB 5400	DVD±RW	Intel 11a/b/g	None	None	6	XP Pro		Oct 07
7650-9MU	T2330	1.60	1GB	15.4" WXGA	GMA	80GB 5400	DVD±RW	Intel 11a/b/g	None	None	6	Business 32		Oct 07
7650-CDU	T5450	1.66	1GB	15.4" WXGA	GMA	80GB 5400	DVD±RW	* Intel 11a/b/g	None	None	6	XP Pro		Jan 08
7650-DHU	T2370	1.73	1GB	15.4" WXGA	GMA	80GB 5400	DVD±RW	Intel 11a/b/g	None	None	6	XP Pro		Feb 08
7650-DGU	T5550	1.83	1GB	15.4" WXGA	GMA	80GB 5400	DVD±RW	* Intel 11a/b/g	None	None	6	XP Pro		Feb 08
7650-DRU	T2390	1.86	1GB	15.4" WXGA	GMA	80GB 5400	DVD±RW	Intel 11a/b/g	None	None	6	Business 32		Apr 08
7650-02U	T2390	1.86	1GB	15.4" WXGA	GMA	80GB 5400	DVD±RW	Intel 11a/b/g	None	None	6	Business 32	Educ	May 08
7650-ELU	T2390	1.86	1GB	15.4" WXGA	GMA	80GB 5400	DVD±RW	Intel 11n ²⁸	None	None	6	XP Pro		July 08
7650-DSU	T5750	2.00	1GB	15.4" WXGA	GMA	80GB 5400	DVD±RW	* Intel 11a/b/g	None	None	6	Business 32		Apr 08
7650-01U	T5750	2.00	2GB	15.4" WXGA	GMA	160G 7200	DVD±RW	* Intel 11a/b/g	None	None	6	Business 32		May 08
7650-F6U	T5750	2.00	1GB	15.4" WXGA	GMA	80GB 5400	DVD±RW	* Intel 11n	None	None	6	XP Pro		July 08

• These small and medium business (SMB) models are part of the US TopSeller™ Program
 • These models have a 1-year limited warranty¹²

Processor	Intel® Pentium® Dual-Core Processor T2330, T2370, or T2390 with dual-core, Intel 64 Technology, Enhanced Intel SpeedStep® technology ¹ , Execute Disable Bit, 533MHz system bus, and 1MB shared L2 cache or Intel Core™ 2 Duo processor T5250, T5450, T5550, or T5750 with dual-core, Intel 64 Technology, Enhanced Intel SpeedStep technology, Execute Disable Bit, 667MHz system bus, and 2MB shared L2 cache	Preloaded operating system ²⁰ - Some: Microsoft® Windows® XP Professional with Vista® COA - Some: Microsoft Windows Vista Business Edition (32-bit) ♦ Vista 1GB models: Vista Basic logo ♦ 01U model: Vista Premium logo
Memory	512MB or 1GB std / 4GB max ⁷ / PC2-5300 667MHz DDR2, non-parity, dual-channel capable, two 200-pin SO-DIMM sockets; <i>Italics:</i> standard memory in both sockets; no sockets available; <i>Non-italics:</i> standard memory in one socket; one socket available	Preloaded applications ¹⁴ (all OSes; only some listed) • Some: Education software - VitalSource Library College Edition - Adobe® Instructor Resource Cntr - Adobe Digital School Collection - Photoshop Elements (and CD) - Premier Elements (and DVD) - Acrobat 8 Professional - Contribute 4 • Lenovo Care SM for Think (9MU and 2008 models) • Microsoft Office OneNote® 2007 and CD (02U model) • Network Magic™ (9MU and 2008 models) • Corel® Small Business Center™ with WordPerfect® Office 12 (9MU and 2008 models) • QuickBooks Financial Center (9MU and 2008 models) • Corel WinDVD® (DVD±RW) • Corel WinDVD Creator (XP Pro DVD±RW model)
Diskette drive	None (use optional USB-based diskette drive)	
EIDE Combo	Some: DVD-ROM/CD-RW, 24X/24X/8X ²¹ , fixed, not removable, 12.7mm high	
EIDE DVD±RW	Some: DVD burner, Super Multi-Burner, dual-layer, not removable, 12.7mm high	
Ultrabay Enhanced	None (no support for removable Ultrabay™ options)	
Serial ATA disk	80GB ⁸ (5400 rpm) or 160GB (7200 rpm) / SATA 1.5Gb/s, 9.5mm high, removable, upgradable, 9.5mm high bay, supports 2nd disk, ThinkPad Shock Mounted Hard Drive, Active Protection System™	
Widescreen display	15.4" (391mm) WXGA (1280x800) color, anti-glare, 200 nits, 16:10 aspect ratio, 300:1 contrast ratio	
Camera	None	
Graphics	Intel Graphics Media Accelerator X3100 (GMA X3100), integrated in GM965, no DVI pass-through (no port replicator or docking station support)	
Keyboard	89-key, ThinkVantage button, spill-resistant, multimedia Fn keys, Windows/Appl keys	
TrackPoint™	TrackPoint® pointing device, "Press-to-Select," Internet Scroll Bar ¹³ (no touch pad)	
ThinkLight™	Illuminates the keyboard to improve visibility in low-light conditions	
Dimensions ³	6-cell 15.4W" (WxDxH): 14.1" x 10.2" x 1.39–1.52"; 358.5 x 260.0mm x 35.3–38.5mm	
Weight ²	6-cell: starting at 6.4 lb (2.9kg); 9-cell: starting at 6.7 lb (3.1kg)	
Case material	Black color, Polycarbonate/Acrylonitrile-Butadiene-Styrene (PC/ABS) plastic	
Battery - type	Lithium Ion 6-cell	
Battery - life ¹⁰	Not published	
Chipset	Mobile Intel GM965 Express Chipset (Graphics Memory Controller Hub); ICH8M I/O Controller Hub (SATA 3.0Gb/s, ATA-100 EIDE, PCI Express® x1, PCI bus, USB, LPC bus, [Bluetooth], / PCI bus (Ricoh® R5C804 Cardbus) /	Supports ThinkVantage® technologies
PC Card Std slot	One Type I or Type II slot, CardBus 32-bit	
ExpressCard slot	None	
Smart Card Read	None	
Multicard Reader	None	
Ports	Three USB 2.0, DB-15 (external VGA monitor), RJ-11 (modem), RJ-45 (ethernet)	
Wireless antenna	UltraConnect™ II antenna / on-off switch for all wireless radios	
Mini PCI Express	One Mini PCI Express slot / not customer upgradable	
Intel 11a/b/g ³²	Some: 11a/b/g wireless ⁴ , Mini PCIe adapter, Intel PRO/Wireless 3945ABG	
Intel 11n ²⁸	Some: 11a/b/g/n wireless ⁴ , Mini PCIe adapter, Intel Wireless WiFi Link 4965AGN, MIMO 2x3 (Kedron)	
WWAN	None	
Modem	56K V.92 ⁶ modem, on systemboard, Conexant® CX20548	
Bluetooth™	None	
Ethernet	Gigabit ethernet, Broadcom® BCM5787M (MAC/PHY), PCIe x1, PXE	
Intel AMT	None	
Audio support	High Definition (HD) Audio, CX20549 codec / stereo speakers, 1 watt / volume up, down, mute buttons / microphone input jack, headphone jack	
Security	Power-on password, hard disk password, supervisor password, security keyhole	
Security chip	None	
Fingerprint reader	None	
Limited warranty ¹² 1-year - EasyServ™ ¹⁹ depot repair service / service upgrades ²² available		
1GB PC2-5300 DDR2 SODIMM (TopSeller)	43R1999	T/R/W/SL Series Li-Ion Battery 9-cell 40Y6797
2GB PC2-5300 DDR2 SODIMM (TopSeller)	43R2000	90W Slim AC/DC Combo Adapter 41N8460
320GB Disk SATA 1.5Gb/s (5400 rpm)	43N3403	ThinkPad Business Topload Case 43R2476
USB 2.0 Lenovo Enhanced Port Replicator	43R8770	ThinkVision® L2440p Wide 24" Monitor 4420HB2
Other accessories on O-R61E sheet		Other accessories at lenovo.com/accessories
		ThinkPlus™ 1-year LOR ²⁴ 9x5 NBD 41C9166
		ThinkPlus 2-year LOR 9x5 NBD 41C9167
		ThinkPlus 3-year LOR 9x5 NBD 41C9168
		ThinkPlus 4-year LOR 9x5 NBD 41C9171
		ThinkPlus 5-year LOR 9x5 NBD 41C9173
		ThinkPlus 2-year P&L P/U Depot 41C9169
		ThinkPlus 3-year P&L P/U Depot 41C9170
		ThinkPlus 4-year P&L P/U Depot 41C9172
		ThinkPlus 5-year P&L P/U Depot 41C9174

See footnotes for important warranty information

* Intel Centrino® processor technology

© Lenovo

US models announced July 1, 2008; previous models on July 10, Oct 2, 2007, Jan 8, Feb 26, April 8, or May 5, 2008

(B-KON11-1) July 2008

US models withdrawn effective December 2007

ThinkPad® R61i 15W 8932 (GMA) - TopSeller (January 2008)

Personal Systems Reference (PSREF)

Type-model	Processor	GHz	Memory	Wide-screen display	Screen type	Camera	Graphics controller	Disk SATA GB ⁶ rpm	EIDE optical	Mini PCIe 802.11 wireless	Card slot	Blue-tooth	Battery cells	Preload	Workhorse (W) Global (G) Avail date
8932-DZU	T5450	1.66	1GB	15.4" WXGA			GMA	120G 5400	DVD±RW	* Intel 11a/b/g ³²	/54		6	XP Pro	No Jan 08
8932-E2U	T5450	1.66	1GB	15.4" WXGA	Glossy	Cam	GMA	160G 5400	DVD±RW	* Intel 11a/b/g	/54	Blue	6	XP Pro	No Jan 08
8932-E9U	T2370	1.73	1GB	15.4" WXGA		Cam	GMA	120G 5400	DVD±RW	* Intel 11a/b/g	/54	Blue	6	XP Pro	No Jan 08
8932-EAU	T5450	1.66	1GB	15.4" WXGA		Cam	GMA	160G 5400	DVD±RW	* Intel 11a/b/g	/54	Blue	6	Business32	No Jan 08
8932-FWU	T2370	1.73	1GB	15.4" WXGA			GMA	120G 5400	DVD±RW	* Intel 11a/b/g	/54		6	XP Pro	No Mar 08
8932-FXU	T5550	1.83	1GB	15.4" WXGA			GMA	120G 5400	DVD±RW	* Intel 11a/b/g	/54		6	XP Pro	No Mar 08
8932-G8U	T2390	1.86	1GB	15.4" WXGA			GMA	160G 5400	DVD±RW	Intel 11a/b/g	/54		6	Business32	No Apr 08
8932-G9U	T2390	1.86	1GB	15.4" WXGA	Glossy	Cam	GMA	160G 5400	DVD±RW	Intel 11a/b/g	/54	Blue	6	Business32	No Apr 08
8932-GBU	T2390	1.86	1GB	15.4" WXGA	Glossy	Cam	GMA	160G 5400	DVD±RW	Intel 11a/b/g	/54	Blue	6	Home Prem	No Apr 08
8932-GZU	T2390	1.86	2GB	15.4" WXGA			GMA	160G 5400	DVD±RW	Intel 11n ²⁸	/54		6	XP Pro	No July 08
8932-GCU	T5750	2.00	1GB	15.4" WXGA			GMA	160G 5400	DVD±RW	* Intel 11a/b/g	/54		6	Business32	No Apr 08
8932-GDU	T5750	2.00	1GB	15.4" WXGA		Cam	GMA	160G 5400	DVD±RW	* Intel 11a/b/g	/54	Blue	6	Business32	No Apr 08
8932-H2U	T5750	2.00	2GB	15.4" WXGA			GMA	160G 5400	DVD±RW	* Intel 11n	/54		6	XP Pro	No July 08

• These small and medium business (SMB) models are part of the US TopSeller™ Program
 • These models have a 1-year limited warranty²

Processor	Intel® Pentium® Dual-Core Processor T2370 or T2390 with dual-core, Intel 64 Technology, Enhanced Intel SpeedStep® technology ¹ , Execute Disable Bit, 533MHz system bus, and 1MB shared L2 cache or Intel Core™ 2 Duo processor T5450, T5550, or T5750 with dual-core, Intel 64 Technology, Enhanced Intel SpeedStep technology ¹ , Execute Disable Bit, 667MHz system bus, and 2MB shared L2 cache	Preloaded operating system ²⁰ - Some: Microsoft® Windows® XP Professional with Vista® COA - Some: Microsoft Windows Vista Business Edition (32-bit) - Some: Microsoft Windows Vista® Home Premium Ed (32-bit) ◇ Vista models: Vista Basic logo
Memory	1GB or 2GB std / 4GB max ⁷ / PC2-5300 667MHz DDR2, non-parity, dual-channel capable, two 200-pin SO-DIMM sockets; <i>Italics:</i> standard memory in both sockets; no sockets available; <i>Non-italics:</i> standard memory in 1 socket; 1 socket available	Preloaded applications ¹⁴ (all OSes; only some listed) • Lenovo Care SM for Think • Rescue and Recovery TM • Access Connections TM • Client Security Solution TM • ThinkVantage System Update • System Migration Assistant • Norton Internet Security (90 days of virus definitions) • PC-Doctor TM (diagnostics) • ThinkPad Utilities (Power Manager and Presentation Director) • Multimedia Center for Think Offerings (XP Pro models) • Microsoft Office 2007 Trial (60-day) • Corel® Small Business Center TM with WordPerfect® Office 12 • Sonic RecordNow and Drive Letter Access (DVD±RW) • Corel WinDVD® (DVD±RW) • Corel WinDVD Creator (XP Pro DVD±RW models)
Diskette drive	None (use optional USB-based diskette drive)	
EIDE DVD±RW	DVD burner, Super Multi-Burner (40Y8624) dual-layer, removable Ultrabay™ Enhanced	
Ultrabay Enhanced	One bay for removable devices, Ultrabay Slim-compatible, 12.7mm high	
Serial ATA disk	120GB ⁸ (5400 rpm) or 160GB (5400 rpm) / SATA 1.5Gb/s, 9.5mm high, removable, upgradable, 9.5mm high bay, supports 2nd disk, ThinkPad Shock Mounted Hard Drive, Active Protection System TM	
Widescreen display	Some: 15.4" (391mm) WXGA (1280x800) TFT color, anti-glare, 200 nits, 16:10 aspect ratio, 300:1 contrast ratio Some: 15.4" (391mm) WXGA (1280x800) TFT color, VibrantView (glossy), 200 nits, 16:10 aspect ratio, 300:1 contrast ratio	
Camera	Some: camera on top of screen, 1.3-megapixel, fixed focus, USB 2.0	
Graphics	Intel Graphics Media Accelerator X3100 (GMA X3100), integrated in GM965, no DVI pass-through support to optional Advanced Mini Dock or Advanced Dock	
Keyboard	89-key, ThinkVantage button, spill-resistant, multimedia Fn keys, Windows/Apl keys	
TrackPoint®	TrackPoint® pointing device, "Press-to-Select," Internet Scroll Bar ¹³ , magnifying glass	
Touch pad	UltraNav™ multi-pointing system, touch pad below keyboard, Tap Zones	
ThinkLight™	Illuminates the keyboard to improve visibility in low-light conditions	
Dimensions ³	6-cell 15.4W" (WxDxH): 14.1" x 10.2" x 1.39–1.52"; 358.5 x 260.0mm x 35.3–38.5mm	
Weight ²	6-cell: starting at 6.4 lb (2.9kg); 9-cell: starting at 6.7 lb (3.1kg)	
Case material	Black color, Polycarbonate/Acrylonitrile-Butadiene-Styrene (PC/ABS) plastic	
Battery - type	Lithium Ion 6-cell, supports unique 2nd battery in Ultrabay Enhanced	
Battery - life ¹⁰	6-cell: up to 5.0 hr; 9-cell: up to 7.0 hr; 6-cell plus Ultrabay battery: up to 8.5 hr	
Chipset	Mobile Intel GM965 Express Chipset (Graphics Memory Controller Hub); ICH8M I/O Controller Hub (SATA 3.0Gb/s, ATA-100 EIDE, PCI Express® x1, PCI bus, USB, LPC bus, [Bluetooth], [fingerprint]) / PCI bus (Ricoh® R5C847 Cardbus/1394/Multicard) / LPC bus (WPCN385 Super I/O, Atmel® 97SC3203 TPM)	Supports ThinkVantage® technologies
PC Card Std slot	One Type I or Type II slot, CardBus 32-bit	
ExpressCard slot	[/54] One ExpressCard/34 or ExpressCard/54	
Smart Card Reader	None	
Multicard Reader	4-in-1 reader (MultiMediaCard, Memory Stick® PRO™, Secure Digital, xD-Picture Card™)	
Ports	Three USB 2.0, DB-15 (external VGA monitor), RJ-11 (modem), RJ-45 (ethernet), IEEE 1394 FireWire 400 (4-pin connector; 1394a-2000 standard), S-Video out	65-watt (GMA graphics) ThinkPad Roll Cage (one-piece magnesium frame) ENERGY STAR® 4.0-compliant RoHS-compliant International Warranty Service ¹⁷ 24 hour x 7 day ¹⁸ toll-free support during the warranty period ¹² via 800-426-7378
Wireless antenna	UltraConnect™ II antenna / on-off switch for all wireless radios	ThinkPlus™.22 1-year LOR ²⁴ 9x5 NBD
Mini PCI Express	One Mini PCI Express slot / 802.11 wireless is customer upgradable	41C9166
Intel 11a/b/g ³²	Some: 11a/b/g wireless ⁴ , Mini PCIe adapter, Intel PRO/Wireless 3945ABG	ThinkPlus 2-year LOR 9x5 NBD
Intel 11n ²⁸	Some: 11a/b/g/n wireless ⁴ , Mini PCIe adapter, Intel Wireless WiFi Link 4965AGN, MIMO 2x3 (Kedron)	41C9167
WWAN	None	ThinkPlus 3-year LOR 9x5 NBD
Turbo Memory	None	41C9168
Modem	56K V.92 ⁶ modem, on systemboard, Conexant® CX20548	ThinkPlus 4-year LOR 9x5 NBD
Bluetooth™	Some: Bluetooth 2.0 wireless, USB 2.0 interface via ICH8M, LED indicator	41C9171
Ethernet	Gigabit ethernet, Broadcom® BCM5787M (MAC/PHY), PCIe x1, PXE	ThinkPlus 5-year LOR 9x5 NBD
Intel AMT	None	41C9173
Audio support	High Definition (HD) Audio, CX20549 codec / stereo speakers, 1 watt / volume up, down, mute buttons / internal microphone, microphone input jack, headphone jack	ThinkPlus 2-year P&L P/U Depot
Security	Power-on password, hard disk password, supervisor password, security keyhole	41C9169
Security chip	Trusted Platform Module, Atmel chip, TCG 1.2-compliant	ThinkPlus 3-year P&L P/U Depot
Fingerprint reader	Fingerprint reader on palm rest, swipe sensor, supported with security chip	41C9170
Limited warranty ¹²	1-year - EasyServ™.19 depot repair service / service upgrades ²² available	ThinkPlus 4-year P&L P/U Depot
		41C9172
		ThinkPlus 5-year P&L P/U Depot
		41C9174

See footnotes for important warranty information * Intel Centrino® processor technology
 8932 US models announced July 1, 2008; previous models on January 8 March 11, or April 8, 2008

ThinkPad®



Lenovo ThinkPad R400



ThinkLight on
Lenovo ThinkPad R400



Lenovo ThinkPad R400



ThinkPad Business Backpack
part number 43R2482



Lenovo ThinkPad R400



Lenovo ThinkPad R400

ThinkPad® R400 7438 (TopSeller)

Type-model	Proc- essor	GHz	Memory	Wide- screen display	Cam- era	Integrated graphics	Disk SATA GB ⁸ rpm	SATA optical	Mini PCIe 802.11 wireless	Mini PCIe WWAN	Mini PCIe UWB or Turbo	Finger print reader	Blue- tooth	Bat- tery cells	Preload	Avail date
7438-T6U	P8400	2.26	2GB	14.1" WXGA		GMA	160G 5400	DVD±RW	Intel 5100 ²⁸	None	None	Finger	Blue	6	XP Pro	Aug 08
7438-T7U	T9400	2.53	2GB	14.1" WXGA	Cam	GMA	160G 7200	DVD±RW	Intel 5100	None	None	Finger	Blue	6	XP Pro	Aug 08

- These small and medium business (SMB) models are part of the US TopSeller™ Program
- These models have an EasyServ™¹⁹ depot repair service 3-year limited warranty

Positioning Processor	Mainstream business performance; two spindles Intel® Core™ 2 Duo processor P8400 or T9400 with dual-core, Intel HD Boost, 1066MHz system bus; P8400: 3MB L2 cache; T9400: 6MB L2 cache											Preloaded operating system ²⁰ - Microsoft® Windows® XP Professional with Vista® COA ◇ Vista Premium logo																																			
Memory	2GB std / 4GB max ⁷ / PC3-8500 1066MHz DDR3 , non-parity, dual-channel capable, two 204-pin SO-DIMM sockets; <i>Italics:</i> standard memory in both sockets; no sockets available											Preloaded applications ¹⁴ • Rescue and Recovery™ • Access Connections™ • Client Security Solution™ • ThinkVantage Productivity Center • ThinkVantage System Update • McAfee VirusScan® Plus with SiteAdvisor™ (30 days of virus definitions) • PC-Doctor™ (diagnostics) • ThinkPad Utilities (Power Manager and Presentation Director) • Adobe® Reader • Windows Live™ Toolbar • Windows Live Search • Fingerprint Software (fingerprint models) • Microsoft Office 2007 Trial (60-day) • Roxio® Creator® Business Edition • Roxio MyDVD® (DVD±RW)																																			
SATA DVD±RW Ultrabay Enhanced SATA disk	DVD burner, SATA 1.5Gb/s, 12.7mm Ultrabay Enhanced, removable (43R9149) One bay for removable devices, Ultrabay Slim-compatible, 12.7mm high 160GB⁸ (5400 or 7200 rpm) / SATA 1.5Gb/s, 2.5" wide, 9.5mm high, removable, upgradable, supports 2nd disk, ThinkPad Shock Mounted Hard Drive, Active Protection System™																																														
Widescreen display Camera	14.1" (358.1mm) WXGA (1280x800) color , anti-glare, CCFL backlight, 185 nits, 16:10 aspect ratio, 300:1 contrast ratio <i>Some:</i> camera on top of screen, 1.3-megapixel, fixed focus																																														
Integrated graphics	Intel Graphics Media Accelerator 4500MHD (GMA 4500MHD) , in GM45, DVI pass-through support to optional Advanced Mini Dock or Advanced Dock <i>Maximum external resolution:</i> 2048x1536@75Hz																																														
Keyboard TrackPoint® Touch pad ThinkLight™	89-key, ThinkVantage button, spill-resistant, multimedia Fn keys TrackPoint® pointing device, "Press-to-Select," Internet Scroll Bar ¹³ , magnifying glass UltraNav™, wide touch pad below keyboard, Tap Zones, scrolling regions label Illuminates the keyboard to improve visibility in low-light conditions																																														
Dimensions ³ Weight ² Case material Battery - type Battery - life ¹⁰	6-cell 14.1W" (WxDxH): 13.2" x 9.4" x 1.2-1.4"; 335.5 x 238mm x 31-35mm 6-cell: starting at 5.1 lb (2.3kg) <i>Top:</i> Super-Elastic PolyCarbonate (SEPC); <i>Bottom:</i> Carbon-Fiber Reinforced Plastic Lithium Ion 6-cell, supports unique 2nd battery in Ultrabay Enhanced 6-cell: up to 5 hr; 6-cell plus Ultrabay battery: up to 6.5 hr; 9-cell: up to 7.5 hr																																														
Chipset ExpressCard/54 PC Card Smart Card Read Multicard Reader Ports	Mobile Intel GM45 Express Chipset (Graphics Memory Controller Hub), ICH9M-Enhanced I/O Controller Hub (SATA 3.0Gb/s, USB 2.0, PCI Express® 1.1, PCI 2.3, security chip, ethernet MAC), LPC bus (WPCN385 Super I/O) One slot (ExpressCard/34, ExpressCard/54) One slot (Type I, Type II), CardBus 32-bit None None Three USB 2.0, external monitor (VGA DB-15), modem (RJ-11), ethernet (RJ-45), IEEE 1394 FireWire 400 (4-pin connector; 1394a-2000 standard)																																														
Mini PCI Express Intel 5100 ²⁸ WWAN 2G Turbo UWB Modem Bluetooth™ Ethernet Intel AMT Audio support Security Security chip Fingerprint reader	Three Mini PCI Express slots 11a/b/g/n wireless ⁴ , Mini PCIe adapter, Intel WiFi Link 5100, 1x2 (Shirley Peak) Not supported None Not supported 56K V.92 ⁶ modem <i>Some:</i> Bluetooth 2.0 wireless, LED indicator Intel 82567LM Gigabit Network Connection (Boazman), PHY, PCIe x1 None High Definition (HD) Audio, AD1984HD codec / stereo speakers, 1 watt / volume up, down, mute buttons / digital microphone, microphone input jack, headphone jack Power-on password, hard disk password, supervisor password, security keyhole Trusted Platform Module, integrated in ICH9M, TCG 1.2-compliant Fingerprint reader on palm rest, swipe sensor, supports the security chip											Supports ThinkVantage® technologies 65-watt (GMA graphics) AC adapter ThinkPad Roll Cage and Top Cover Roll Cage (one-piece magnesium) EPEAT™ Silver rating ENERGY STAR® 4.0-compliant RoHS-compliant International Warranty Service ¹⁷ 24 hour x 7 day ¹⁸ toll-free support during the warranty period ¹² via 800-426-7378																																			
Limited warranty ¹²	3-years/1-yr battery - EasyServ™ ¹⁹ depot repair service / service upgrades ²² available											ThinkPlus™ ²² 2-year LOR 9x5 NBD 41C9175 ThinkPlus 3-year LOR 9x5 NBD 41C9176 ThinkPlus 4-year LOR 9x5 NBD 43R2499 ThinkPlus 5-year LOR 9x5 NBD 41C9177 ThinkPlus 4-year P&L P/U Depot 43R2482 ThinkPlus 5-year P&L P/U Depot 43R2472 4424HB6 4422HB6 4421HB2 Post-warranty annual maintenance agreements at lenovo.com/thinkplus/warranty																																			
1GB PC3-8500 DDR3 SODIMM (TopSeller)	43R2045	T/R 14W Standard Battery 4-cell	41U3196	2GB PC3-8500 DDR3 SODIMM (TopSeller)	43R2046	T/R 14W Enhanced Battery 6-cell	41U3198	Blu-ray™ Burner Ultrabay Enhanced	43R9150	T/R 14W High Capacity Battery 9-cell	43R2499	Serial ATA Hard Drive Bay Adapter II	43R1980	Advanced Ultrabay Battery II 3-cell	43R9250	90W Slim AC/DC Combo Adapter	41N8460	64GB SSD SATA 3.0Gb/s 1.8" (2.5" cover)	43N3400	ThinkPad Business Topload Case	43R2476	320GB Disk SATA 1.5Gb/s (5400 rpm)	43N3403	ThinkPad Business Backpack	43R2482	USB 2.0 Security Memory Key 4GB	41U5120	T400/R400 Series 14W Privacy Filter	43R2472	USB 2.0 Ultra Secure Memory Key 8GB	45J5918	ThinkVision® L1940p Wide 19" Monitor	4424HB6	USB 2.0 Super Multi-Burner Drive	41N5565	ThinkVision L2240p Wide 22" Monitor	4422HB6	ThinkPad Adjustable Notebook Stand	40Y7676	ThinkVision L2440x Wide 24" Monitor	4421HB2	ThinkPad Advanced Dock	250310U	Other accessories at lenovo.com/accessories			

See footnotes for important warranty information
US models announced August 5, 2008

✦ Intel Centrino® 2 processor technology

© Lenovo
(LAG3-1) August 2008

Type-model	Processor GHz	Memory	Wide-screen display	Camera	Integrated graphics	Disk SATA GB ³ rpm	SATA optical	Mini PCIe 802.11 wireless	Mini PCIe WWAN	Mini PCIe UWB or Turbo	Finger Card print reader	Blue-tooth	Battery Preload	Whorse (W) Gbl (G) Avail date
7439-1WU	Cel 575	2.00 2GB	14.1" WXGA		GMA 160G 5400 DVD±RW	Intel 5100 ²⁸	None	None	None	PC	Fing	Blue	6 Bus 32	Sep 08
7439-11U	P8400	2.26 1GB	14.1" WXGA		GMA 80G 5400 Combo	Intel 5100	None	None	None	PC	Fing	Blue	6 Bus 32	G Aug 08
7439-12U	T9400	2.53 1GB	14.1" WXGA		GMA 160G 5400 Combo	Intel 5100	None	None	None	PC	Fing	Blue	6 Bus 32	WG Aug 08
7439-V1U	T9400	2.53 2GB	14.1" WXGA	Cam	GMA 160G 7200 DVD±RW	Intel 5100	None	2G Turbo	7-in-1	Fing	Blue	6 Bus 32	WG Aug 08	
7439-V2U	P8400	2.26 1GB	14.1" WXGA	Cam	GMA 160G 5400 Combo	Intel 5100	None	None	7-in-1	Fing	Blue	6 Bus 32	WG Aug 08	
7439-V5U	T9400	2.53 1GB	14.1" WXGA	Cam	GMA 160G 5400 DVD±RW	Intel 5100	None	None	7-in-1	Fing	Blue	6 Bus 32	WG Aug 08	
7439-1BU	P8600	2.40 2GB	14.1" WXGA+		GMA 160G 5400 DVD±RW	Intel 5100	None	2G Turbo	7-in-1	Fing	Blue	6 Bus 32	WG Aug 08	
7439-1CU	T9400	2.53 2GB	14.1" WXGA		GMA 160G 5400 DVD±RW	Intel 5300 ²⁸	None	2G Turbo	7-in-1	Fing	Blue	6 Bus 32	WG Aug 08	
7439-1TU	P8600	2.40 1GB	14.1" WXGA		GMA 160G 5400 DVD±RW	Intel 5100	None	None	Smart			6 Bus 32	TAA Aug 08	
7439-PAU	P8600	2.40 2GB	14.1" WXGA		GMA 160G 5400 Combo	Intel 5100	None	None	PC	Fing	Blue	6 XP Pro	G Sep 08	
7439-PCU	P8600	2.40 2GB	14.1" WXGA+		GMA 160G 5400 DVD±RW	Intel 5100	None	2G Turbo	7-in-1	Fing	Blue	6 XP Pro	G Sep 08	
7439-T1U	P8600	2.40 2GB	14.1" WXGA		GMA 160G 5400 Combo	Intel 5100	None	None	PC	Fing	Blue	6 XP Pro	G Sep 08	
7439-V3U	T9400	2.53 2GB	14.1" WXGA	Cam	GMA 160G 7200 DVD±RW	Intel 5100	None	UWB	7-in-1	Fing	Blue	9 Bus 32	W Oct 08	
7439-T2U	P8600	2.40 1GB	14.1" WXGA		GMA 160G 5400 DVD±RW	Intel 5100	None	None	Smart			6 Bus 32	TAA Oct 08	
7439-PDU	P8600	2.40 2GB	14.1" WXGA		GMA 160G 5400 DVD±RW	Intel 5100	None	None	PC	Fing	Blue	6 Bus 32	WG Dec 08	

US Govt (TAA) ⁵ Processor	1TU/2TU: US Government model (Trade Act Agreement-compliant) Intel® Celeron® Processor 575 with single-core, 667MHz system bus, and 1MB L2 cache Intel Core™ 2 Duo processor P8400, P8600, or T9400 with dual-core, Intel HD Boost, 1066MHz system bus; P8400/P8600: 3MB L2 cache; T9400: 6MB L2 cache										Preloaded operating system²⁰ - Some: Microsoft® Windows® XP Professional with Vista® COA - Some: Microsoft Windows Vista Business Edition (32-bit) ◇ Vista Premium logo			
Memory	1GB or 2GB std / 4GB max ⁷ / PC3-8500 1066MHz DDR3 , non-parity, dual-channel capable, two 204-pin SO-DIMM sockets; <i>Italics:</i> standard memory in both sockets; no sockets available; <i>Non-italics:</i> standard memory in one socket; one socket available										Preloaded applications¹⁴ (all OSes) • Rescue and Recovery™ • Access Connections™ • Client Security Solution™ • ThinkVantage Productivity Center • ThinkVantage System Update • McAfee VirusScan® Plus with SiteAdvisor™ (30 days of virus definitions) • PC-Doctor™ (diagnostics) • ThinkPad Utilities (Power Manager and Presentation Director) • Adobe® Reader • Windows Live™ Toolbar • Windows Live Search • Fingerprint Software (fingerprint models)			
SATA Combo SATA DVD±RW Ultrabay Enhanced SATA disk	Some: DVD-ROM/CD-RW, SATA 1.5Gb/s, 12.7mm Ultrabay Enh, removable (43R9148) Some: DVD burner, SATA 1.5Gb/s, 12.7mm Ultrabay Enhanced, removable (43R9149) One bay for removable devices, Ultrabay Slim-compatible, 12.7mm high 80GB⁸ (5400 rpm) or 160GB (5400 or 7200 rpm) / SATA 1.5Gb/s, 2.5" wide, 9.5mm high, removable, upgradable, supports 2nd disk, ThinkPad Shock Mounted Hard Drive, Active Protection System™										• Microsoft Office 2007 Trial (60-day) • Roxio® Creator® Business Edition • Roxio MyDVD® (DVD±RW)			
Widescreen display	Some: 14.1" (358.1mm) WXGA (1280x800) color , anti-glare, CCFL backlight, 185 nits, 16:10 aspect ratio, 300:1 contrast ratio Some: 14.1" (358.1mm) WXGA+ (1440x900) color , anti-glare, CCFL backlight, 200 nits, 16:10 aspect ratio, 300:1 contrast ratio													
Camera	Some: camera on top of screen, 1.3-megapixel, fixed focus													
Integrated graphics	Intel Graphics Media Accelerator 4500MHD (GMA 4500MHD) , in GM45, DVI pass-through support to optional Advanced Mini Dock or Advanced Dock <i>Maximum external resolution:</i> 2048x1536 @ 75Hz (VGA DB-15)													
Keyboard TrackPoint® Touch pad ThinkLight™	89-key, ThinkVantage button, spill-resistant, multimedia Fn keys TrackPoint® pointing device, "Press-to-Select," Internet Scroll Bar ¹³ , magnifying glass UltraNav™, wide touch pad below keyboard, Tap Zones, scrolling regions label Illuminates the keyboard to improve visibility in low-light conditions													
Dimensions ³ Weight ² Case color Case material Battery - type Battery - life ¹⁰	6-cell 14.1W" (WxDxH): 13.2" x 9.4" x 1.2-1.4"; 335.5 x 238mm x 31-35mm 6-cell: starting at 5.1 lb (2.3kg) Black Top: Super-Elastic PolyCarbonate (SEPC); Bottom: Carbon-Fiber Reinforced Plastic Lithium Ion 6-cell or 9-cell, supports unique 2nd battery in Ultrabay Enhanced 6-cell: up to 5 hr; 6-cell plus Ultrabay battery: up to 6.5 hr; 9-cell: up to 7.5 hr													
Chipset	Mobile Intel GM45 Express Chipset (Graphics Memory Controller Hub), ICH9M-Enhanced I/O Controller Hub (SATA 3.0Gb/s, USB 2.0, PCI Express® 1.1, PCI 2.3, security chip, ethernet MAC), LPC bus (WPCN385 Super I/O)										Supports ThinkVantage® technologies			
ExpressCard/54 PC Card Smart Card read Multicard reader Ports	One slot (ExpressCard/34, ExpressCard/54) Some: One slot (Type I, Type II), CardBus 32-bit Some: Smart Card reader Some: 7-in-1 reader (MMC, Memory Stick, Mem Stick Pro, SD, SDHC, XD, XD Type H) Three USB 2.0, external monitor (VGA DB-15), modem (RJ-11), ethernet (RJ-45), IEEE 1394 FireWire 400 (4-pin connector; 1394a-2000 standard)										65-watt (GMA graphics) AC adapter ThinkPad Roll Cage and Top Cover Roll Cage (one-piece magnesium) EPEAT™ Silver rating ENERGY STAR® 4.0-compliant RoHS-compliant International Warranty Service ¹⁷ 24 hour x 7 day ¹⁸ toll-free support during the warranty period ¹² via 800-426-7378			
Mini PCI Express Intel 5100 ²⁸ Intel 5300 ²⁸ WWAN 2G Turbo UWB Modem Bluetooth™ Ethernet Intel AMT Audio support	Three Mini PCI Express slots Some: 11a/b/g/n wireless ⁴ , Mini PCIe adapter, Intel WiFi Link 5100, 1x2 (Shirley Peak) Some: 11a/b/g/n wireless ⁴ , Mini PCIe adapter, Intel WiFi Link 5300, 3x3 (Shirley Peak) None Some: Intel Turbo Memory, Mini PCIe adapter, 2GB flash, disk-cache accelerator Wireless USB based on Ultra-Wideband (UWB), Half-Mini PCIe adapter 56K V.92 ⁶ modem Some: Bluetooth 2.0 wireless, LED indicator Intel 82567LM Gigabit Network Connection (Boazman), PHY, PCIe x1 None										ThinkPlus™.22 2-year LOR 9x5 NBD 41C9175 ThinkPlus 3-year LOR 9x5 NBD 41C9176 ThinkPlus 4-year LOR 9x5 NBD 41C9177 ThinkPlus 5-year LOR 9x5 NBD 41C9179			
Security Security chip Fingerprint reader	Power-on password, hard disk password, supervisor password, security keyhole Trusted Platform Module, integrated in ICH9M, TCG 1.2-compliant Some: Fingerprint reader on palm rest, swipe sensor, supports the security chip										ThinkPlus 4-year P&L P/U Depot 41C9178 ThinkPlus 5-year P&L P/U Depot 41C9180			
Limited warranty ¹²	3-years/1-yr battery - EasyServ™.19 depot repair service / service upgrades ²² available										Post-warranty annual maintenance agreements at lenovo.com/thinkplus/warranty			
320GB Disk Other accessories on O-R400 sheet	SATA 1.5Gb/s (5400 rpm) 43N3403		T/R 14W High Capacity Battery 9-cell 43R2499		Other accessories at lenovo.com/accessories									

See footnotes for important warranty information

◇ Intel Centrino® 2 processor technology

Ⓜ US models announced December 2, 2008; previous models on Aug 5, Sep 2, Sep 30, or October 7, 2008

Proc- Type-model	essor GHz	Memory	Wide- screen display	Cam-Integrated era graphics	Disk SATA GB ⁸ rpm	SATA optical	Mini PCIe 802.11 wireless	Mini PCIe WWAN	Mini PCIe UWB or Turbo	Card slot	Blue/ Fing	Bat- tery cells	Whorse (W) Gbl (G) Avail Preload GMP (P) date
7440-11U	P8400	2.26 1GB 14.1" WXGA		GMA 80G	5400 Combo	⇄ Intel 5100 ²⁸	None			PC	Yes	6 Bus 32	G P Aug 08
7440-12U	T9400	2.53 1GB 14.1" WXGA		GMA 160G	5400 Combo	⇄ Intel 5100	None			PC	Yes	6 Bus 32	W G P Aug 08
7440-V1U	T9400	2.53 2GB 14.1" WXGA	Cam	GMA 160G	7200 DVD±RW	⇄ Intel 5100	None	2G Turbo		7-in-1	Yes	6 Bus 32	W G P Aug 08
7440-V5U	T9400	2.53 1GB 14.1" WXGA	Cam	GMA 160G	5400 DVD±RW	⇄ Intel 5100	None			7-in-1	Yes	6 Bus 32	W G P Aug 08
7440-T1U	P8600	2.40 2GB 14.1" WXGA		GMA 160G	5400 Combo	⇄ Intel 5100	None			PC	Yes	6 XP Pro	G P Sep 08
7440-PDU	P8600	2.40 2GB 14.1" WXGA		GMA 160G	5400 DVD±RW	⇄ Intel 5100	None			PC	Yes	6 Bus 32	W G P Dec 08

• These models are part of the Global Models Plus program with limited onsite service²⁴ 3-year limited warranty

Positioning Processor	Mainstream business performance; two spindles Intel® Core™ 2 Duo processor P8400, P8600, or T9400 with dual-core, Intel HD Boost, 1066MHz system bus; P8400/P8600: 3MB L2 cache; T9400: 6MB L2 cache	Preloaded operating system ²⁰ - Some: Microsoft® Windows® XP Professional with Vista® COA - Some: Microsoft Windows Vista Business Edition (32-bit) ◇ Vista Premium logo
Memory	1GB or 2GB std / 4GB max ⁷ / PC3-8500 1066MHz DDR3 , non-parity, dual-channel capable, two 204-pin SO-DIMM sockets; <i>Italics:</i> standard memory in both sockets; no sockets available; <i>Non-italics:</i> standard memory in one socket; one socket available	Preloaded applications ¹⁴ (all OSes) • Rescue and Recovery™ • Access Connections™ • Client Security Solution™ • ThinkVantage Productivity Center • ThinkVantage System Update • McAfee VirusScan® Plus with SiteAdvisor™ (30 days of virus definitions) • PC-Doctor™ (diagnostics) • ThinkPad Utilities (Power Manager and Presentation Director) • Adobe® Reader • Windows Live™ Toolbar • Windows Live Search • Fingerprint Software (fingerprint models) • Microsoft Office 2007 Trial (60-day) • Roxio® Creator® Business Edition • Roxio MyDVD® (DVD±RW)
SATA Combo SATA DVD±RW Ultrabay Enhanced SATA disk	<i>Some:</i> DVD-ROM/CD-RW, SATA 1.5Gb/s, 12.7mm Ultrabay Enh, removable (43R9148) <i>Some:</i> DVD burner, SATA 1.5Gb/s, 12.7mm Ultrabay Enhanced, removable (43R9149) One bay for removable devices, Ultrabay Slim-compatible, 12.7mm high 80GB⁹ (5400 rpm) 160GB (5400 or 7200 rpm) / SATA 1.5Gb/s, 2.5" wide, 9.5mm high, removable, upgradable, supports 2nd disk, ThinkPad Shock Mounted Hard Drive, Active Protection System™	
Widescreen display Camera	14.1" (358.1mm) WXGA (1280x800) color , anti-glare, CCFL backlight, 185 nits, 16:10 aspect ratio, 300:1 contrast ratio <i>Some:</i> camera on top of screen, 1.3-megapixel, fixed focus	
Integrated graphics	Intel Graphics Media Accelerator 4500MHD (GMA 4500MHD) , in GM45, DVI pass-through support to optional Advanced Mini Dock or Advanced Dock <i>Maximum external resolution:</i> 2048x1536@75Hz	
Keyboard TrackPoint® Touch pad ThinkLight™	89-key, ThinkVantage button, spill-resistant, multimedia Fn keys TrackPoint® pointing device, "Press-to-Select," Internet Scroll Bar ¹³ , magnifying glass UltraNav™, wide touch pad below keyboard, Tap Zones, scrolling regions label Illuminates the keyboard to improve visibility in low-light conditions	
Dimensions ³ Weight ² Case color Case material Battery - type Battery - life ¹⁰	<i>6-cell 14.1W" (WxDxH):</i> 13.2" x 9.4" x 1.2–1.4"; 335.5 x 238mm x 31–35mm <i>6-cell:</i> starting at 5.1 lb (2.3kg) Black <i>Top:</i> Super-Elastic PolyCarbonate (SEPC); <i>Bottom:</i> Carbon-Fiber Reinforced Plastic Lithium Ion 6-cell , supports unique 2nd battery in Ultrabay Enhanced <i>6-cell:</i> up to 5 hr; <i>6-cell plus Ultrabay battery:</i> up to 6.5 hr; <i>9-cell:</i> up to 7.5 hr	
Chipset	Mobile Intel GM45 Express Chipset (Graphics Memory Controller Hub) / ICH9M-Enhanced I/O Controller Hub (SATA 3.0Gb/s, USB 2.0, PCI Express® 1.1, PCI 2.3, security chip, ethernet MAC), LPC bus (WPCN385 Super I/O) One slot (ExpressCard/34, ExpressCard/54) <i>Some:</i> One slot (Type I, Type II), CardBus 32-bit	
ExpressCard/54 PC Card Smart Card read Multicard reader Ports	<i>Some:</i> 7-in-1 reader (MMC, Memory Stick, Mem Stick Pro, SD, SDHC, XD, XD Type H) Three USB 2.0, external monitor (VGA DB-15), modem (RJ-11), ethernet (RJ-45), IEEE 1394 FireWire 400 (4-pin connector; 1394a-2000 standard)	
Mini PCI Express Intel 5100 ²⁸ WWAN 2G Turbo UWB Modem Bluetooth™ Ethernet Intel AMT Audio support	Three Mini PCI Express slots 11a/b/g/n wireless ⁴ , Mini PCIe adapter, Intel WiFi Link 5100, 1x2 (Shirley Peak) None <i>Some:</i> Intel Turbo Memory, Mini PCIe adapter, 2GB flash, disk-cache accelerator None 56K V.92 ⁶ modem Bluetooth 2.0 wireless, LED indicator Intel 82567LM Gigabit Network Connection (Boazman), PHY, PCIe x1 None High Definition (HD) Audio, AD1984HD codec / stereo speakers, 1 watt / volume up, down, mute buttons / digital microphone, microphone input jack, headphone jack	
Security Security chip Fingerprint reader	Power-on password, hard disk password, supervisor password, security keyhole Trusted Platform Module, integrated in ICH9M, TCG 1.2-compliant Fingerprint reader on palm rest, swipe sensor, supports the security chip	Supports ThinkVantage® technologies
Limited warranty ¹²	3-years/1-year battery, limited onsite service²⁴ , 8 am - 5 pm, Mon - Fri coverage excluding holidays, next business day response time / service upgrades ²² available	65-watt (GMA graphics) AC adapter ThinkPad Roll Cage and Top Cover Roll Cage (one-piece magnesium) EPEAT™ Silver rating ENERGY STAR® 4.0-compliant RoHS-compliant International Warranty Service ¹⁷ 24 hour x 7 day ¹⁸ toll-free support during the warranty period ¹² via 800-426-7378
1GB PC3-8500 DDR3 SODIMM 2GB PC3-8500 DDR3 SODIMM Blu-ray™ Burner Ultrabay Enhanced SATA Serial ATA Hard Drive Bay Adapter II SATA 64GB SSD SATA 3.0Gb/s 1.8" (2.5" cover) 320GB Disk SATA 1.5Gb/s (5400 rpm) USB 2.0 Essential Memory Key 32GB USB 2.0 Ultra Secure Memory Key 8GB USB 2.0 Super Multi-Burner Drive ThinkPad Adjustable Notebook Stand ThinkPad Advanced Dock Other accessories on O-R400 sheet	43R1987 43R1988 43R9150 43R1980 43N3400 43N3403 45K1258 45J5918 41N5565 40Y7676 250310U	T/R 14W Standard Battery 4-cell 41U3196 T/R 14W Enhanced Battery 6-cell 41U3198 T/R 14W High Capacity Battery 9-cell 43R2499 Advanced Ultrabay Battery II 3-cell 43R9250 90W Slim AC/DC Combo Adapter 41N8460 ThinkPad Business Topload Case 43R2476 ThinkPad Business Backpack 43R2482 T400/R400 Series 14W Privacy Filter 43R2472 ThinkVision® L1940p Wide 19" Monitor 4424HB6 ThinkVision L2240p Wide 22" Monitor 4422HB6 ThinkVision L2440p Wide 24" Monitor 4420HB2 Other accessories at lenovo.com/accessories

See footnotes for important warranty information
 ☞ US model announced December 2, 2008; previous models on August 5 or September 2, 2008

ThinkPad® R400 7439 (Education) - EasyServ

Personal Systems Reference (PSREF)

Type-model	Proc- essor	GHz	Memory	Wide- screen display	Cam-Integrated era graphics	SATA GB ⁸	Disk SATA rpm	SATA optical	Mini PCIe 802.11 wireless	Mini PCIe WWAN	Mini PCIe UWB or Turbo	Finger print reader	Bat- tery cells	Whorse (W) Gbl (G)	Avail date	
7439-E1U	Cel 585	2.16	1GB	14.1" WXGA	Cam GMA	80G	5400 Combo		Intel 5100 ²⁸	None	2G Turbo	7-in-1	6	Bus 32	W Sep 08	
7439-E2U	T9400	2.53	1GB	14.1" WXGA	Cam GMA	80G	5400 Combo		Intel 5100	None	2G Turbo	7-in-1	6	Bus 32	W Aug 08	
7439-E3U	T9400	2.53	1GB	14.1" WXGA	Cam GMA	160G	5400 DVD±RW		Intel 5100	None	2G Turbo	7-in-1	Fing	6	Bus 32	W Aug 08
7439-E4U	T9400	2.53	2GB	14.1" WXGA	Cam GMA	160G	7200 DVD±RW		Intel 5100	None	2G Turbo	7-in-1	Fing	9	Bus 32	W Aug 08
7439-E5U	P8600	2.40	2GB	14.1" WXGA	Cam GMA	160G	5400 DVD±RW		Intel 5100	None	2G Turbo	7-in-1	6	Bus 32	W Dec 08	
<p>• These models have an EasyServ™,19 depot repair service 3-year limited warranty</p> <p>These educational models are available only to public or private K-12 or higher accredited schools organized and operated exclusively for educational purposes for use by qualified students and teachers.</p>																
Positioning Processor	<p><i>Mainstream business performance; two spindles</i> Intel® Celeron® Processor 585 with single-core, 667MHz system bus, and 1MB L2 cache Intel Core™ 2 Duo processor P8600 or T9400 with dual-core, Intel HD Boost, 1066MHz system bus; <i>P8600</i>: 3MB L2 cache; <i>T9400</i>: 6MB L2 cache</p>											<p>Preloaded operating system²⁰</p> <ul style="list-style-type: none"> Microsoft® Windows® Vista® Business Edition (32-bit) ◇ Vista Premium logo 				
Memory	<p>1GB or 2GB std / 4GB max⁷ / PC3-8500 1066MHz DDR3, non-parity, dual-channel capable, two 204-pin SO-DIMM sockets; <i>Italics:</i> standard memory in both sockets; no sockets available; <i>Non-italics:</i> standard memory in one socket; one socket available</p>											<p>Preloaded applications¹⁴</p> <ul style="list-style-type: none"> Education software Microsoft Office OneNote® 2007 (and CD) VitalSource Library College Edition Adobe® Instructor Resource Cntr Adobe Digital School Collection – Photoshop Elements (and CD) – Premier Elements (and DVD) – Acrobat 8 Professional – Contribute 4 Rescue and Recovery™ Access Connections™ Client Security Solution™ ThinkVantage Productivity Center ThinkVantage System Update McAfee VirusScan® Plus with SiteAdvisor™ (30 days of virus definitions) PC-Doctor™ (diagnostics) ThinkPad Utilities (Power Manager and Presentation Director) Adobe® Reader Windows Live™ Toolbar Windows Live Search Fingerprint Software (fingerprint models) Microsoft Office 2007 Trial (60-day) Roxio® Creator® Business Edition Roxio MyDVD® (DVD±RW) 				
SATA Combo SATA DVD±RW Ultrabay Enhanced SATA disk	<p><i>Some:</i> DVD-ROM/CD-RW, SATA 1.5Gb/s, 12.7mm Ultrabay Enh, removable (43R9148) <i>Some:</i> DVD burner, SATA 1.5Gb/s, 12.7mm Ultrabay Enhanced, removable (43R9149) One bay for removable devices, Ultrabay Slim-compatible, 12.7mm high 80GB⁸ (5400 rpm) or 160GB (5400 or 7200 rpm) / SATA 1.5Gb/s, 2.5" wide, 9.5mm high, removable, upgradable, supports 2nd disk, ThinkPad Shock Mounted Hard Drive, Active Protection System™</p>															
Widescreen display	<p><i>Some:</i> 14.1" (358.1mm) WXGA (1280x800) color, anti-glare, CCFL backlight, 185 nits, 16:10 aspect ratio, 300:1 contrast ratio <i>Some:</i> 14.1" (358.1mm) WXGA+ (1440x900) color, anti-glare, CCFL backlight, 200 nits, 16:10 aspect ratio, 300:1 contrast ratio</p>															
Camera	<p><i>Some:</i> camera on top of screen, 1.3-megapixel, fixed focus</p>															
Integrated graphics	<p>Intel Graphics Media Accelerator 4500MHD (GMA 4500MHD), in GM45, DVI pass-through support to optional Advanced Mini Dock or Advanced Dock <i>Maximum external resolution:</i> 2048x1536@75Hz</p>															
Keyboard TrackPoint® Touch pad ThinkLight™	<p>89-key, ThinkVantage button, spill-resistant, multimedia Fn keys TrackPoint® pointing device, "Press-to-Select," Internet Scroll Bar¹³, magnifying glass UltraNav™, wide touch pad below keyboard, Tap Zones, scrolling regions label Illuminates the keyboard to improve visibility in low-light conditions</p>															
Dimensions ³ Weight ² Case color Case material Battery - type Battery - life ¹⁰	<p><i>6-cell 14.1W" (WxDxH):</i> 13.2" x 9.4" x 1.2–1.4"; 335.5 x 238mm x 31–35mm <i>6-cell:</i> starting at 5.1 lb (2.3kg) Black <i>Top:</i> Super-Elastic PolyCarbonate (SEPC); <i>Bottom:</i> Carbon-Fiber Reinforced Plastic Lithium Ion 6-cell or 9-cell, supports unique 2nd battery in Ultrabay Enhanced <i>6-cell:</i> up to 5 hr; <i>6-cell plus Ultrabay battery:</i> up to 6.5 hr; <i>9-cell:</i> up to 7.5 hr</p>															
Chipset	<p>Mobile Intel GM45 Express Chipset (Graphics Memory Controller Hub), ICH9M-Enhanced I/O Controller Hub (SATA 3.0Gb/s, USB 2.0, PCI Express® 1.1, PCI 2.3, security chip, ethernet MAC), LPC bus (WPCN385 Super I/O) One slot (ExpressCard/34, ExpressCard/54)</p>															
ExpressCard/54 PC Card Smart Card read Multicard reader Ports	<p>None None 7-in-1 reader (MMC, Memory Stick, Mem Stick PRO™, SD, SDHC, XD, XD Type H) Three USB 2.0, external monitor (VGA DB-15), modem (RJ-11), ethernet (RJ-45), IEEE 1394 FireWire 400 (4-pin connector; 1394a-2000 standard)</p>											<p>Supports ThinkVantage® technologies</p>				
Mini PCI Express Intel 5100 ²⁸ WWAN 2G Turbo UWB Modem Bluetooth™ Ethernet Intel AMT Audio support	<p>Three Mini PCI Express slots 11a/b/g/n wireless⁴, Mini PCIe adapter, Intel WiFi Link 5100, 1x2 (Shirley Peak) None <i>Some:</i> Intel Turbo Memory, Mini PCIe adapter, 2GB flash, disk-cache accelerator None 56K V.92⁶ modem Bluetooth 2.0 wireless, LED indicator Intel 82567LM Gigabit Network Connection (Boazman), PHY, PCIe x1 None High Definition (HD) Audio, AD1984HD codec / stereo speakers, 1 watt / volume up, down, mute buttons / digital microphone, microphone input jack, headphone jack</p>											<p>65-watt (GMA graphics) AC adapter ThinkPad Roll Cage and Top Cover Roll Cage (one-piece magnesium) EPEAT™ Silver rating ENERGY STAR® 4.0-compliant RoHS-compliant International Warranty Service¹⁷ 24 hour x 7 day¹⁸ toll-free support during the warranty period¹² via 800-426-7378</p>				
Security Security chip Fingerprint reader	<p>Power-on password, hard disk password, supervisor password, security keyhole Trusted Platform Module, integrated in ICH9M, TCG 1.2-compliant <i>Some:</i> Fingerprint reader on palm rest, swipe sensor, supports the security chip</p>											<p>ThinkPlus™,22 2-year LOR 9x5 NBD 41C9175 ThinkPlus 3-year LOR 9x5 NBD 41C9176 ThinkPlus 4-year LOR 9x5 NBD 41C9177 ThinkPlus 5-year LOR 9x5 NBD 41C9179</p>				
Limited warranty ¹²	<p>3-years/1-yr battery - EasyServ™,19 depot repair service / service upgrades²² available</p>											<p>ThinkPlus 4-year P&L P/U Depot 41C9178 ThinkPlus 5-year P&L P/U Depot 41C9180 Post-warranty annual maintenance agreements at lenovo.com/thinkplus/warranty</p>				
1GB PC3-8500 DDR3 SODIMM 2GB PC3-8500 DDR3 SODIMM Serial ATA Hard Drive Bay Adapter II SATA 320GB Disk SATA 1.5Gb/s (5400 rpm) USB 2.0 Ultra Secure Memory Key 8GB USB 2.0 Super Multi-Burner Drive ThinkPad Advanced Dock Other accessories on O-R400 sheet	<p>43R1987 43R1988 43R1980 43N3403 45J5918 41N5565 250310U</p>		<p>T/R 14W Enhanced Battery 6-cell T/R 14W High Capacity Battery 9-cell Advanced Ultrabay Battery II 3-cell 90W Slim AC/DC Combo Adapter ThinkPad Business Topload Case T400/R400 Series 14W Privacy Filter ThinkVision® L2440x Wide 24" Monitor Other accessories at lenovo.com/accessories</p>		<p>41U3198 43R2499 43R9250 41N8460 43R2476 43R2472 4421HB2</p>											

See footnotes for important warranty information

⚡ Intel Centrino® 2 processor technology

© Lenovo

Ⓜ US model announced December 2, 2008; previous models on August 5 or September 30, 2008

(LAG3-4) December 2008

ThinkPad® R400 7440 (Education) - Onsite

Personal Systems Reference (PSREF)

Proc- Type-model	essor GHz	Memory	Wide- screen display	Cam- era	Integrated graphics	Disk SATA GB ⁸ rpm	SATA optical	Mini PCIe 802.11 wireless	Mini PCIe WWAN	Mini PCIe UWB or Turbo	Finger print reader	Bat- tery cells	Whorse (W) Gbl (G) Preload	Avail date
7440-1NU	P8600	2.40	1GB	14.1" WXGA	None	GMA 80G	5400 Combo	Intel 5100	None	2G Turbo	7-in-1	None	Blue	6 Bus 32 W Aug 08

• This model has a limited onsite service²⁴ 3-year limited warranty

Educational models are available only to public or private K-12 or higher accredited schools organized and operated exclusively for educational purposes for use by qualified students and teachers.

Positioning Processor	<i>Mainstream business performance; two spindles</i> Intel® Core™ 2 Duo processor P8600 with dual-core, Intel HD Boost, 1066MHz system bus, and 3MB L2 cache										Preloaded operating system²⁰ - Microsoft® Windows® Vista® Business Edition (32-bit) - Vista Premium logo			
Memory	1GB std / 4GB max ⁷ / PC3-8500 1066MHz DDR3 , non-parity, dual-channel capable, two 204-pin SO-DIMM sockets; <i>Non-italics:</i> standard memory in one socket; one socket available										Preloaded applications¹⁴ • Education software - Microsoft Office OneNote® 2007 (and CD) - VitalSource Library College Edition - Adobe® Instructor Resource Cntr - Adobe Digital School Collection - Photoshop Elements (and CD) - Premier Elements (and DVD) - Acrobat 8 Professional - Contribute 4 • Rescue and Recovery™ • Access Connections™ • Client Security Solution™ • ThinkVantage Productivity Center • ThinkVantage System Update • McAfee VirusScan® Plus with SiteAdvisor™ (30 days of virus definitions) • PC-Doctor™ (diagnostics) • ThinkPad Utilities (Power Manager and Presentation Director) • Adobe® Reader • Windows Live™ Toolbar • Windows Live Search • Fingerprint Software (fingerprint models) • Microsoft Office 2007 Trial (60-day) • Roxio® Creator® Business Edition • Roxio MyDVD® (DVD±RW)			
SATA Combo Ultrabay Enhanced SATA disk	DVD-ROM/CD-RW, SATA 1.5Gb/s, 12.7mm Ultrabay Enh, removable (43R9148) One bay for removable devices, Ultrabay Slim-compatible, 12.7mm high 80GB⁸ (5400 rpm) 160GB (5400 or 7200 rpm) / SATA 1.5Gb/s, 2.5" wide, 9.5mm high, removable, upgradable, supports 2nd disk, ThinkPad Shock Mounted Hard Drive, Active Protection System™													
Widescreen display Camera	14.1" (358.1mm) WXGA (1280x800) color , anti-glare, CCFL backlight, 185 nits, 16:10 aspect ratio, 300:1 contrast ratio													
Integrated graphics	Intel Graphics Media Accelerator 4500MHD (GMA 4500MHD) , in GM45, DVI pass-through support to optional Advanced Mini Dock or Advanced Dock <i>Maximum external resolution:</i> 2048x1536@75Hz													
Keyboard TrackPoint® Touch pad ThinkLight™	89-key, ThinkVantage button, spill-resistant, multimedia Fn keys TrackPoint® pointing device, "Press-to-Select," Internet Scroll Bar ¹³ , magnifying glass UltraNav™, wide touch pad below keyboard, Tap Zones, scrolling regions label Illuminates the keyboard to improve visibility in low-light conditions													
Dimensions ³ Weight ² Case material Battery - type Battery - life ¹⁰	<i>6-cell 14.1W" (WxDxH):</i> 13.2" x 9.4" x 1.2-1.4"; 335.5 x 238mm x 31-35mm <i>6-cell:</i> starting at 5.1 lb (2.3kg) <i>Top:</i> Super-Elastic PolyCarbonate (SEPC); <i>Bottom:</i> Carbon-Fiber Reinforced Plastic Lithium Ion 6-cell , supports unique 2nd battery in Ultrabay Enhanced <i>6-cell:</i> up to 5 hr; <i>6-cell plus Ultrabay battery:</i> up to 6.5 hr; <i>9-cell:</i> up to 7.5 hr													
Chipset	Mobile Intel GM45 Express Chipset (Graphics Memory Controller Hub), ICH9M-Enhanced I/O Controller Hub (SATA 3.0Gb/s, USB 2.0, PCI Express® 1.1, PCI 2.3, security chip, ethernet MAC), LPC bus (WPCN385 Super I/O)													
ExpressCard slot PC Card Std slot Smart Card Read Multicard Reader Ports	One ExpressCard/34 or ExpressCard/54 None None 7-in-1 reader (MMC, Memory Stick, Mem Stick Pro, SD, SDHC, XD, XD Type H) Three USB 2.0, external monitor (VGA DB-15), modem (RJ-11), ethernet (RJ-45), IEEE 1394 FireWire 400 (4-pin connector; 1394a-2000 standard)													
Mini PCI Express Intel 5100 ²⁸ WWAN 2G Turbo UWB Modem Bluetooth™ Ethernet Intel AMT Audio support Security Security chip Fingerprint reader	Three Mini PCI Express slots 11a/b/g/n wireless ⁴ , Mini PCIe adapter, Intel WiFi Link 5100, 1x2 (Shirley Peak) None Intel Turbo Memory, Mini PCIe adapter, 2GB flash, disk-cache accelerator None 56K V.92 ⁶ modem Bluetooth 2.0 wireless, LED indicator Intel 82567LM Gigabit Network Connection (Boazman), PHY, PCIe x1 None High Definition (HD) Audio, AD1984HD codec / stereo speakers, 1 watt / volume up, down, mute buttons / digital microphone, microphone input jack, headphone jack Power-on password, hard disk password, supervisor password, security keyhole Trusted Platform Module, integrated in ICH9M, TCG 1.2-compliant None													
Limited warranty ¹²	3-years/1-year battery, limited onsite service²⁴ , 8 am - 5 pm, Mon - Fri coverage excluding holidays, next business day response time / service upgrades ²² available										Supports ThinkVantage® technologies			
1GB PC3-8500 DDR3 SODIMM 2GB PC3-8500 DDR3 SODIMM DVD Burner Ultrabay Enh SATA 1.5Gb/s Blu-ray™ Burner Ultrabay Enhanced SATA Serial ATA Hard Drive Bay Adapter II SATA 64GB SSD SATA 3.0Gb/s 1.8" (2.5" cover) 320GB Disk SATA 1.5Gb/s (5400 rpm) USB 2.0 Security Memory Key 4GB USB 2.0 Ultra Secure Memory Key 8GB USB 2.0 Super Multi-Burner Drive ThinkPad Adjustable Notebook Stand ThinkPad Advanced Dock Laser Tilt Wheel Travel Mouse (Bluetooth) Other accessories on O-R400 sheet	43R1987 43R1988 43R9149 43R9150 43R1980 43N3400 43N3403 41U5120 45J5918 41N5565 40Y7676 250310U 41U5008										T/R 14W Standard Battery 4-cell 41U3196 T/R 14W Enhanced Battery 6-cell 41U3198 T/R 14W High Capacity Battery 9-cell 43R2499 Advanced Ultrabay Battery II 3-cell 43R9250 90W Slim AC/DC Combo Adapter 41N8460 ThinkPad Business Topload Case 43R2476 ThinkPad Business Backpack 43R2482 T400/R400 Series 14W Privacy Filter 43R2472 ThinkVision® L1700p 17" Monitor 9417HE2 ThinkVision L1940p Wide 19" Monitor 4424HB6 ThinkVision L2240p Wide 22" Monitor 4422HB6 ThinkVision L2440x Wide 24" Monitor 4421HB2 ThinkVision USB Soundbar (up to 22") 40Y7616 Other accessories at lenovo.com/accessories			
											65-watt (GMA graphics) AC adapter ThinkPad Roll Cage and Top Cover Roll Cage (one-piece magnesium) EPEAT™ Silver rating ENERGY STAR® 4.0-compliant RoHS-compliant International Warranty Service ¹⁷ 24 hour x 7 day ¹⁸ toll-free support during the warranty period ¹² via 800-426-7378			
											ThinkPlus™. ²² 4-year LOR 9x5 NBD 12X5630 Post-warranty annual maintenance agreements at lenovo.com/thinkplus/warranty			

See footnotes for important warranty information
US models announced August 5, 2008

• Intel Centrino® 2 processor technology

© Lenovo
(LAG3-5) August 2008

Partial list of accessories supported on:

• ThinkPad R400 originally announced on August 5, 2008

Memory

1GB PC3-8500 DDR3 SODIMM (TopSeller)	43R2045	ann	11/04/08
1GB PC3-8500 DDR3 SODIMM	43R1987	ann	08/05/08
2GB PC3-8500 DDR3 SODIMM (TopSeller)	43R2046	ann	11/04/08
2GB PC3-8500 DDR3 SODIMM	43R1988	ann	08/05/08

Ultrabay Slim 9.5mm

Serial ATA Hard Drive Bay Adapter II SATA ⁴⁸	43R1980	ann	08/05/08
DVD-ROM Ultrabay Slim SATA 1.5Gb/s ⁴⁸	43N3212	ann	08/05/08
CD-RW/DVD-ROM Ultrabay Slim SATA ⁴⁸	43N3213	ann	08/05/08
DVD Burner Ultrabay Slim SATA 1.5Gb/s ⁴⁸	43N3214	ann	08/05/08
Blu-ray™ Burner Ultrabay Slim SATA 1.5Gb/s ⁴⁸	43N3215	ann	08/05/08

⁴⁸ Slim 9.5mm device in 12.7mm bay shows gap above the device.

Ultrabay Enhanced 12.7mm

DVD-ROM Ultrabay Enhanced SATA 1.5Gb/s	43R9147	ann	08/05/08
CD-RW/DVD-ROM Ultrabay Enh SATA	43R9148	ann	08/05/08
DVD Burner Ultrabay Enh SATA 1.5Gb/s	43R9149	ann	08/05/08
Blu-ray™ Burner Ultrabay Enh SATA 1.5Gb/s	43R9150	ann	08/05/08

Storage and removable storage

160GB Disk SATA 1.5Gb/s (5400 rpm) ⁴¹	41N5692	ann	03/20/07
160GB Disk SATA 1.5Gb/s (7200 rpm) ⁴¹	41N5737	ann	10/16/07
200GB Disk FDE SATA 1.5Gb/s (7200 rpm) ⁴¹	41N5738	ann	10/16/07
250GB Disk SATA 1.5Gb/s (5400 rpm) ⁴¹	43R8152	ann	01/15/08
320GB Disk SATA 1.5Gb/s (5400 rpm) ⁴¹	43N3403	ann	08/05/08

⁴¹ Can be used as the main HDD or with *Serial ATA Hard Drive Bay Adapter 43R1980* in the Ultrabay or (in the *ThinkPad Advanced Dock 250310U* with *Serial Hard Drive Ultrabay Slim Adapter 40Y8725*)

128GB SSD SATA 3.0Gb/s 1.8" (2.5" cover)	43N3406	ann	08/26/08
USB 2.0 Essential Memory Key 8GB	45J7905	ann	07/15/08
USB 2.0 Essential Memory Key 32GB	45K1258	ann	10/28/08
USB 2.0 Security Memory Key 4GB	41U5120	ann	07/17/07
USB 2.0 Ultra Secure Memory Key 2GB	45J5916	ann	08/26/08
USB 2.0 Ultra Secure Memory Key 4GB	45J5917	ann	08/26/08
USB 2.0 Ultra Secure Memory Key 8GB	45J5918	ann	08/26/08
USB Portable Diskette Drive	05K9276	ann	06/05/00
USB 2.0 CD-RW/DVD-ROM Combo II Drive	40Y8637	ann	01/05/06
USB 2.0 Portable 160GB Hard Disk	43R1784	ann	09/23/08
USB 2.0 Portable Secure 160GB Hard Disk	43R2018	ann	11/18/08
USB 2.0 Portable Secure 320GB Hard Disk	43R2019	ann	11/18/08
USB 2.0 Super Multi-Burner Drive	41N5565	ann	01/23/07

ThinkPad Expansion

USB 2.0 Lenovo Enhanced Port Replicator	43R8770	ann	02/26/08
ThinkPad Adjustable Notebook Stand	40Y7676	ann	09/20/05
ThinkPad Essential Port Replicator	250510W	ann	09/20/05
ThinkPad Advanced Mini Dock	250410U	ann	09/20/05
ThinkPad Advanced Dock	250310U	ann	09/20/05

Keyboard

TrackPoint Cap Collection	73P2698	ann	12/16/03
USB Numeric Keypad	33L3225	ann	05/01/00
Preferred Pro USB Keyboard	73P5220	ann	06/21/05
Enhanced Performance USB Keyboard	73P2620	ann	03/23/04
Wireless Kybd & Opt Wheel Mouse (via USB)	73P4067	ann	12/07/04
USB Keyboard with UltraNav	31P8950	ann	01/28/03
USB Travel Keyboard with UltraNav	31P9490	ann	04/27/04
Lenovo USB Fingerprint Keyboard	73P4730	ann	02/22/05

Mouse

Optical Wheel Mouse (USB)	06P4069	ann	05/21/03
Optical ScrollPoint® Mouse (USB, PS/2)	31P7405	ann	08/27/02
Optical Wheel Travel Mouse (USB, PS/2)	31P7410	ann	06/04/02
Laser Tilt Wheel Mouse (USB, PS/2)	41U3074	ann	01/23/07
Lenovo Wireless Laser Mouse (blk, via USB)	45K1696	ann	11/25/08
Lenovo Wireless Laser Mouse (red, via USB)	51J0198	ann	11/25/08
Laser Tilt Wheel Travel Mouse (Bluetooth)	41U5008	ann	01/22/08

Security

Kensington® Cable Lock from Lenovo	73P2582	ann	12/29/03
Kensington Twin Head Cable Lock	45K1620	ann	09/30/08
T400/R400 Series 14W Privacy Filter	43R2472	ann	08/05/08
USB Gemplus GemPC Smart Card Reader	41N3040	ann	02/21/06
PC Card Gemplus Smart Card Reader	41N3004	ann	12/13/05
ExpressCard Gemplus Smart Card Reader	41N3043	ann	06/27/06

Multimedia

USB 2.0 Lenovo Multimedia Headset	40Y8518	ann	06/27/06
USB 2.0 Lenovo Webcam	40Y8519	ann	08/29/06

Batteries

T/R 14W Standard Battery 4-cell	41U3196	ann	05/09/07
T/R 14W Enhanced Battery 6-cell	41U3198	ann	05/09/07
T/R 14W High Capacity Battery 9-cell	43R2499	ann	03/04/08
Advanced Ultrabay Battery II 3-cell ⁴³	43R9250	ann	04/22/08

⁴³ Used in Ultrabay Slim bay.
ThinkPad External Battery Charger⁴⁴ 40Y7625 ann 09/20/05
⁴⁴ Requires the *ThinkPad 90W AC Adapter 40Y7659* (adapter provided with some systems).

More information at www.lenovo.com/alldaycomputing

ThinkPad 65W AC Adapter ⁴⁵	40Y7696	ann	01/05/06
---------------------------------------	---------	-----	----------

⁴⁵ Only compatible with the GM45 chipset models.
ThinkPad 90W AC Adapter 40Y7659 ann 09/20/05
ThinkPad 90W Slim AC/DC Combo Adapter 41N8460 ann 11/27/07

More info at www.lenovo.com/support/poweradapters

Charging tips for 90W Slim AC/DC Combo Adapter 41N8460

•Dual (ThinkPad+Phone) Charging Y-Cable	41R4345	ann	12/18/07
•Palm device charge tip (L7)	41R4315	ann	12/18/07
•BlackBerry charge tip (L8a)	41R4478	ann	12/18/07
•iPod and iPhone charge tip (L10a)	41R4481	ann	12/18/07

More information at www.lenovo.com/support/slimadaptertips

Carrying Cases

Up to 14.1" widescreen models:

ThinkPad Expander Case	43R9118	ann	06/24/08
ThinkPad Women's Microfiber Tote	22P8855		
ThinkPad Women's Leather Trim Tote	22P8856		
ThinkPad Convertible Carrying Case	22P8860		
ThinkPad Women's Executive Leather Tote	22P8857		
Women's Executive Red Leather Tote	22P8858		

Up to 15.4" widescreen models:

Lenovo Carrying Case - Messenger Max	41U5253	ann	05/01/07
Lenovo Carr Case - Performance Backpack	41U5254	ann	05/01/07
Lenovo Standard Case	45K1697	ann	11/25/08
Lenovo Standard Backpack	45K1698	ann	11/25/08
ThinkPad Business Topload Case	43R2476	ann	05/13/08
ThinkPad Business Backpack	43R2482	ann	05/13/08
ThinkPad Deluxe Expander Case	43R2478	ann	05/13/08
ThinkPad Executive Leather Case	43R2480	ann	05/13/08

Up to 17.0" widescreen models:

ThinkPad 17W Business Topload Case	43R9117	ann	08/12/08
------------------------------------	---------	-----	----------

Lenovo luxury cases at www.lenovoluxurycases.com

Monitors

ThinkVision® L174 17" Monitor	9227AE1	ann	04/15/08
ThinkVision L1700p 17" Monitor	9417HE2	ann	09/17/08
ThinkVision L1900p 19" Monitor	4431HE1	ann	11/11/08
ThinkVision L1940p Wide 19" Monitor	4424HB6	ann	09/17/08
ThinkVision L200p Wide 20.1" Monitor	4438HB6	ann	04/15/08
ThinkVision L2240p Wide 22" Monitor	4422HB6	ann	09/17/08
ThinkVision L2440p Wide 24" Monitor	4420HB2	ann	09/17/08
ThinkVision L2440x Wide 24" Monitor	4421HB2	ann	09/17/08

Monitor Accessories⁴⁶

ThinkVision USB Soundbar	40Y7616	ann	08/23/05
ThinkVision Soundbar	45K1263	ann	09/16/08
Kensington Cable Lock from Lenovo	73P2582	ann	12/29/03
Kensington Twin Head Cable Lock	45K1620	ann	09/30/08
ThinkPad Convertible Monitor Stand	40Y7620	ann	01/05/06
Radial Arm	19K4464	ann	05/05/00

⁴⁶ Compatible on selected Lenovo and ThinkVision monitors.

More information at www.lenovo.com/support/monitoraccessories

Other accessories at www.lenovo.com/accessories

Accessories Guide pdf at www.lenovo.com/accessoriesguide



Lenovo ThinkPad R500



Lenovo ThinkPad R500



Lenovo ThinkPad R500



Lenovo ThinkPad R500

Type-model	Processor	GHz	Memory	Wide-screen display	Camera	Integrated graphics	Disk SATA GB ⁸ rpm	SATA optical	Mini PCIe 802.11 wireless	Mini PCIe Turbo	Finger print reader	Blue-tooth	Battery cells	Workhorse (W) Global (G) Avail date
2717-5GU	P8400	2.26	2GB	15.4" WXGA		GMA	160G 5400	DVD±RW	Intel 5100 ²⁸	None	Finger		6	XP Pro No Aug 08
2717-5HU	T9400	2.53	2GB	15.4" WXGA	Cam	GMA	160G 7200	DVD±RW	Intel 5100	None	Finger	Blue	6	XP Pro No Aug 08

- These small and medium business (SMB) models are part of the US TopSeller™ Program
- These models have an EasyServ™¹⁹ depot repair service 3-year limited warranty

Positioning Processor	Mainstream business performance; two spindles Intel® Core™ 2 Duo processor P8400 or T9400 with dual-core, Intel HD Boost, 1066MHz system bus; P8400: 3MB L2 cache; T9400: 6MB L2 cache											Preloaded operating system ²⁰ - Microsoft® Windows® XP Professional with Vista® COA ◇ Vista Premium logo																																	
Memory	2GB std / 4GB max ⁷ / PC3-8500 1066MHz DDR3, non-parity, dual-channel capable, two 204-pin SO-DIMM sockets; <i>Italics:</i> standard memory in both sockets; no sockets available;											Preloaded applications ¹⁴ • Rescue and Recovery™ • Access Connections™ • Client Security Solution™ • ThinkVantage Productivity Center • ThinkVantage System Update • McAfee VirusScan® Plus with SiteAdvisor™ (30 days of virus definitions) • PC-Doctor™ (diagnostics) • ThinkPad Utilities (Power Manager and Presentation Director) • Adobe® Reader • Windows Live™ Toolbar • Windows Live Search • Fingerprint Software (fingerprint models) • Microsoft Office 2007 Trial (60-day) • Roxio® Creator® Business Edition • Roxio MyDVD® (DVD±RW)																																	
SATA DVD±RW Ultrabay Enhanced SATA disk	DVD burner, SATA 1.5Gb/s, 12.7mm Ultrabay Enhanced, removable (43R9149) 160GB ⁸ (5400 or 7200 rpm) / SATA 1.5Gb/s, 2.5" wide, 9.5mm high, removable, upgradable, supports 2nd disk, ThinkPad Shock Mounted Hard Drive, Active Protection System™																																												
Widescreen display Camera	15.4" (391mm) WXGA (1280x800) color, anti-glare, CCFL backlight, 185 nits, 16:10 aspect ratio, 300:1 contrast ratio <i>Some:</i> camera on top of screen, 1.3-megapixel, fixed focus																																												
Integrated graphics	Intel Graphics Media Accelerator 4500MHD (GMA 4500MHD), in GM45, digital monitor support via DisplayPort (supports single-link DVI-D via cable 45J7915); Maximum external resolution: 2048x1536@75Hz																																												
Keyboard TrackPoint® Touch pad ThinkLight™	89-key, ThinkVantage button, spill-resistant, multimedia Fn keys TrackPoint® pointing device, "Press-to-Select," Internet Scroll Bar ¹³ , magnifying glass UltraNav™, wide touch pad below keyboard, Tap Zones, scrolling regions label Illuminates the keyboard to improve visibility in low-light conditions																																												
Dimensions ³ Weight ² Case Battery - type Battery - life ¹⁰	6-cell 15.4W" (WxDxH): 14.1" x 10.2" x 1.4–1.5"; 358.6mm x 260mm x 36–39mm 6-cell: starting at 6.4 lb (2.93kg) Color: black; Material: Polycarbonate/Acrylonitrile-Butadiene-Styrene (PC/ABS) plastic Lithium Ion 6-cell, supports unique 2nd battery in Ultrabay Enhanced 6-cell: up to 4.5 hr; 6-cell plus Ultrabay battery: up to 6.0 hr; 9-cell: up to 7.1 hr																																												
Chipset ExpressCard/54 PC Card Smart Card Reader Multicard Reader Ports	Mobile Intel GM45 Express Chipset (Graphics Memory Controller Hub), ICH9M I/O Controller Hub (SATA 3.0Gb/s, USB 2.0, PCI Express® 1.1, PCI 2.3, security chip, ethernet MAC), LPC bus (WPCN385 Super I/O) One slot (ExpressCard/34, ExpressCard/54) One slot (Type I, Type II), CardBus 32-bit None 7-in-1 reader (MMC, Memory Stick, Mem Stick Pro, SD, SDHC, XD, XD Type H) Three USB 2.0, external monitor (VGA DB-15, DisplayPort), modem (RJ-11), ethernet (RJ-45), IEEE 1394 FireWire 400 (4-pin connector; 1394a-2000 standard)																																												
Mini PCI Express Intel 5100 ²⁸ 2G Turbo WWAN UWB Modem Bluetooth™ Ethernet Intel AMT Audio support Security Security chip Fingerprint reader	Two Mini PCI Express slots 11a/b/g/n wireless ⁴ , Mini PCIe adapter, Intel WiFi Link 5100, 1x2 (Shirley Peak) None Not supported Not supported 56K V.92 ⁶ modem <i>Some:</i> Bluetooth 2.0 wireless, LED indicator Gigabit ethernet, Broadcom® BCM5787M (MAC/PHY), PCIe x1, PXE None High Definition (HD) Audio, AD1984HD codec / stereo speakers, 1 watt / volume up, down, mute buttons / digital microphone, microphone input jack, headphone jack Power-on password, hard disk password, supervisor password, security keyhole Trusted Platform Module, integrated in ICH9M, TCG 1.2-compliant Fingerprint reader on palm rest, swipe sensor, supports the security chip											Supports ThinkVantage® technologies 65-watt (GMA graphics) AC adapter ThinkPad Roll Cage (one-piece magnesium frame) EPEAT™ Silver rating ENERGY STAR® 4.0-compliant RoHS-compliant International Warranty Service ¹⁷ 24 hour x 7 day ¹⁸ toll-free support during the warranty period ¹² via 800-426-7378																																	
Limited warranty ¹²	3-years/1-yr battery - EasyServ™ ¹⁹ depot repair service / service upgrades ²² available											ThinkPlus™ ²² 2-year LOR 9x5 NBD 41C9175 ThinkPlus 3-year LOR 9x5 NBD 41C9176 ThinkPlus 4-year LOR 9x5 NBD 41C9177 ThinkPlus 5-year LOR 9x5 NBD 41C9179 ThinkPlus 4-year P&L P/U Depot 41C9178 ThinkPlus 5-year P&L P/U Depot 41C9180 Post-warranty annual maintenance agreements at lenovo.com/thinkplus/warranty																																	
1GB PC3-8500 DDR3 SODIMM (TopSeller)	43R2045	T/R/W/SL Series Li-Ion Battery 6-cell	40Y6799	2GB PC3-8500 DDR3 SODIMM (TopSeller)	43R2046	T/R/W/SL Series Li-Ion Battery 9-cell	40Y6797	Blu-ray Burner Ultrabay Enhanced	43R9150	Advanced Ultrabay Battery II 3-cell	43R9250	Serial ATA Hard Drive Bay Adapter II	43R1980	90W Slim AC/DC Combo Adapter	41N8460	ThinkPad Business Topload Case	43R2476	64GB SSD SATA 3.0Gb/s 1.8" (2.5" cover)	43N3400	ThinkPad Business Backpack	43R2482	ThinkPad Business Memory Key 4GB	41U5120	ThinkPad Deluxe Expander Case	43R2478	USB 2.0 Security Memory Key 8GB	45J5918	T500/R500/W500 15W Privacy Filter	43R2474	ThinkVision® L1940p Wide 19" Monitor	4424HB6	USB 2.0 Ultra Secure Memory Key 4GB	41U5120	ThinkVision L2240p Wide 22" Monitor	4422HB6	USB 2.0 Super Multi-Burner Drive	41N5565	ThinkVision L2440p Wide 24" Monitor	4420HB2	ThinkPad Adjustable Notebook Stand	40Y7676	Other accessories on O-R500 sheet	250310U	Other accessories at lenovo.com/accessories	

See footnotes for important warranty information
US models announced August 5, 2008

◇ Intel Centrino® 2 processor technology

© Lenovo
(WKK3-1) August 2008

Type-model	Processor	GHz	Memory	Wide-screen display	Cam-era	Integrated graphics	Disk SATA GB ⁸ rpm	SATA optical	Mini PCIe 802.11 wireless	Mini PCIe Turbo	Finger print reader	Blue-tooth	Bat-tery cells	Workhorse (W) Global (G) Avail date
2716-EBU	Cel 575	2.00	2GB	15.4" WXGA	Cam	GMA	160G 5400	DVD±RW	Intel 5100 ²⁸	None	Finger	Blue	9	Bus 32 Sep 08
2716-3KU	P8400	2.26	1GB	15.4" WXGA		GMA	80G 5400	Combo	Intel 5100	None	Finger	Blue	6	Bus 32 G Aug 08
2716-3LU	T9400	2.53	1GB	15.4" WXGA		GMA	160G 5400	DVD±RW	Intel 5100	None	Finger	Blue	6	Bus 32 W G Aug 08
2716-3MU	T9400	2.53	2GB	15.4" WXGA	Cam	GMA	160G 5400	DVD±RW	Intel 5100	None	Finger	Blue	9	Bus 32 W G Aug 08
2716-6JU	P8400	2.26	1GB	15.4" WXGA		GMA	80G 5400	Combo	Intel 5100	None	Finger	Blue	6	XP Pro G Sep 08
2716-6LU	P8400	2.26	1GB	15.4" WXGA		GMA	80G 5400	DVD±RW	Intel 5100	None			6	XP Pro G Sep 08
<p>• These models have an EasyServ™,19 depot repair service 3-year limited warranty</p>														
Positioning Processor	<p>Mainstream business performance; two spindles Intel® Celeron® Processor 575 with single-core, 667MHz system bus, and 1MB L2 cache Intel Core™ 2 Duo processor P8400 or T9400 with dual-core, Intel HD Boost, 1066MHz system bus; P8400: 3MB L2 cache; T9400: 6MB L2 cache</p>										<p>Preloaded operating system²⁰ - Some: Microsoft® Windows® XP Professional with Vista® COA - Some: Microsoft Windows Vista Business Edition (32-bit) ⇨ Vista Premium logo</p>			
Memory	<p>1GB or 2GB std / 4GB max⁷ / PC3-8500 1066MHz DDR3, non-parity, dual-channel capable, two 204-pin SO-DIMM sockets; <i>Italics:</i> standard memory in both sockets; no sockets available; <i>Non-italics:</i> standard memory in one socket; one socket available</p>										<p>Preloaded applications¹⁴ (all OSes) • Rescue and Recovery™ • Access Connections™ • Client Security Solution™ • ThinkVantage Productivity Center • ThinkVantage System Update • McAfee VirusScan® Plus with SiteAdvisor™ (30 days of virus definitions) • PC-Doctor™ (diagnostics) • ThinkPad Utilities (Power Manager and Presentation Director) • Adobe® Reader • Windows Live™ Toolbar • Windows Live Search • Fingerprint Software (fingerprint models) • Microsoft Office 2007 Trial (60-day) • Roxio® Creator® Business Edition • Roxio MyDVD® (DVD±RW)</p>			
SATA Combo SATA DVD±RW Ultrabay Enhanced SATA disk	<p><i>Some:</i> DVD-ROM/CD-RW, SATA 1.5Gb/s, 12.7mm Ultrabay Enh, removable (43R9148) <i>Some:</i> DVD burner, SATA 1.5Gb/s, 12.7mm Ultrabay Enhanced, removable (43R9149) One bay for removable devices, Ultrabay Slim-compatible, 12.7mm high 80GB⁹ (5400 rpm) or 160GB (5400 rpm) / SATA 1.5Gb/s, 2.5" wide, 9.5mm high, removable, upgradable, supports 2nd disk, ThinkPad Shock Mounted Hard Drive, Active Protection System™</p>													
Widescreen display Camera	<p>15.4" (391mm) WXGA (1280x800) color, anti-glare, CCFL backlight, 185 nits, 16:10 aspect ratio, 300:1 contrast ratio <i>Some:</i> camera on top of screen, 1.3-megapixel, fixed focus</p>													
Integrated graphics	<p>Intel Graphics Media Accelerator 4500MHD (GMA 4500MHD), in GM45, digital monitor support via DisplayPort (supports single-link DVI-D via cable 45J7915); <i>Maximum external resolution:</i> 2048x1536@75Hz</p>													
Keyboard TrackPoint® Touch pad ThinkLight™	<p>89-key, ThinkVantage button, spill-resistant, multimedia Fn keys TrackPoint® pointing device, "Press-to-Select," Internet Scroll Bar¹³, magnifying glass UltraNav™, wide touch pad below keyboard, Tap Zones, scrolling regions label Illuminates the keyboard to improve visibility in low-light conditions</p>													
Dimensions ³ Weight ² Case Battery - type Battery - life ¹⁰	<p>6-cell 15.4W" (WxDxH): 14.1" x 10.2" x 1.4–1.5"; 358.6mm x 260mm x 36–39mm 6-cell: starting at 6.4 lb (2.93kg) Color: black; Material: PolyCarbonate/Acrylonitrile-Butadiene-Styrene (PC/ABS) plastic Lithium Ion 6-cell or 9-cell, supports unique 2nd battery in Ultrabay Enhanced 6-cell: up to 4.5 hr; 6-cell plus Ultrabay battery: up to 6.0 hr; 9-cell: up to 7.1 hr</p>													
Chipset	<p>Mobile Intel GM45 Express Chipset (Graphics Memory Controller Hub), ICH9M I/O Controller Hub (SATA 3.0Gb/s, USB 2.0, PCI Express® 1.1, PCI 2.3, security chip, ethernet MAC), LPC bus (WPCN385 Super I/O)</p>													
ExpressCard/54 PC Card Smart Card Read Multicard Reader Ports	<p>One slot (ExpressCard/34, ExpressCard/54) One slot (Type I, Type II), CardBus 32-bit None 7-in-1 reader (MMC, Memory Stick, Mem Stick Pro, SD, SDHC, XD, XD Type H) Three USB 2.0, external monitor (VGA DB-15, DisplayPort), modem (RJ-11), ethernet (RJ-45), IEEE 1394 FireWire 400 (4-pin connector; 1394a-2000 standard)</p>										<p>Supports ThinkVantage® technologies</p>			
Mini PCI Express Intel 5100 ²⁸ 2G Turbo WWAN UWB Modem Bluetooth™ Ethernet Intel AMT Audio support	<p>Two Mini PCI Express slots 11a/b/g/n wireless⁴, Mini PCIe adapter, Intel WiFi Link 5100, 1x2 (Shirley Peak) None Not supported Not supported 56K V.92⁶ modem Some: Bluetooth 2.0 wireless, LED indicator Gigabit ethernet, Broadcom® BCM5787M (MAC/PHY), PCIe x1, PXE None High Definition (HD) Audio, AD1984HD codec / stereo speakers, 1 watt / volume up, down, mute buttons / digital microphone, microphone input jack, headphone jack</p>										<p>65-watt (GMA graphics) AC adapter ThinkPad Roll Cage (one-piece magnesium frame) EPEAT™ Silver rating ENERGY STAR® 4.0-compliant RoHS-compliant International Warranty Service¹⁷ 24 hour x 7 day¹⁸ toll-free support during the warranty period¹² via 800-426-7378</p>			
Security Security chip Fingerprint reader	<p>Power-on password, hard disk password, supervisor password, security keyhole Trusted Platform Module, integrated in ICH9M, TCG 1.2-compliant Some: Fingerprint reader on palm rest, swipe sensor, supports the security chip</p>										<p>ThinkPlus™.22 2-year LOR 9x5 NBD 41C9175 ThinkPlus 3-year LOR 9x5 NBD 41C9176 ThinkPlus 4-year LOR 9x5 NBD 41C9177 ThinkPlus 5-year LOR 9x5 NBD 41C9179 ThinkPlus 4-year P&L P/U Depot 43R2476 ThinkPlus 5-year P&L P/U Depot 43R2482 ThinkPad Deluxe Expander Case 43R2478 T500/R500/W500 15W Privacy Filter 43R2474 ThinkVision® L2440x Wide 24" Monitor 4421HB2 Other accessories at lenovo.com/accessories</p>			
Limited warranty ¹²	<p>3-years/1-yr battery - EasyServ™,19 depot repair service / service upgrades²² available</p>													
1GB PC3-8500 DDR3 SODIMM 2GB PC3-8500 DDR3 SODIMM Serial ATA Hard Drive Bay Adapter II SATA 320GB Disk SATA 1.5Gb/s (5400 rpm) USB 2.0 Essential Memory Key 32GB USB 2.0 Ultra Secure Memory Key 8GB USB 2.0 Super Multi-Burner Drive ThinkPad Adjustable Notebook Stand ThinkPad Advanced Dock Other accessories on O-R500 sheet	43R1987 43R1988 43R1980 43N3403 45K1258 45J5918 41N5565 40Y7676 250310U	T/R/W/SL Series Li-Ion Battery 6-cell T/R/W/SL Series Li-Ion Battery 9-cell Advanced Ultrabay Battery II 3-cell 90W Slim AC/DC Combo Adapter ThinkPad Business Topload Case ThinkPad Business Backpack ThinkPad Deluxe Expander Case T500/R500/W500 15W Privacy Filter ThinkVision® L2440x Wide 24" Monitor	40Y6799 40Y6797 43R9250 41N8460 43R2476 43R2482 43R2478 43R2474 4421HB2											

See footnotes for important warranty information
 † Intel Centrino® 2 processor technology
 † US model announced September 30, 2008; previous models on August 5 or September 2, 2008

Type-model	Processor	GHz	Memory	Wide-screen display	Camera	Integrated graphics	Disk SATA GB ⁸ rpm	SATA optical	Mini PCIe 802.11 wireless	Mini PCIe Turbo	Finger print reader	Blue-tooth	Battery cells	Preload	Whorse (W) Gbl (G) GMP (P)	Avail date
2718-3KU	P8400	2.26	1GB	15.4" WXGA		GMA	80G 5400	Combo	Intel 5100 ²⁸	None	Finger	Blue	6	Bus 32	G P	Aug 08
2718-3LU	T9400	2.53	1GB	15.4" WXGA		GMA	160G 5400	DVD±RW	Intel 5100	None	Finger	Blue	6	Bus 32	WG P	Aug 08
2718-3MU	T9400	2.53	2GB	15.4" WXGA	Cam	GMA	160G 5400	DVD±RW	Intel 5100	None	Finger	Blue	9	Bus 32	WG P	Aug 08
2718-6LU	P8400	2.26	1GB	15.4" WXGA		GMA	80G 5400	DVD±RW	Intel 5100	None			6	XP Pro	G P	Sep 08

• These models are part of the Global Models Plus program with limited onsite service²⁴ 3-year limited warranty

Positioning Processor	<i>Mainstream business performance; two spindles</i> Intel® Core™ 2 Duo processor P8400 or T9400 with dual-core, Intel HD Boost, 1066MHz system bus; P8400: 3MB L2 cache; T9400: 6MB L2 cache										Preloaded operating system²⁰ - Some: Microsoft® Windows® XP Professional with Vista® COA - Some: Microsoft Windows Vista Business Edition (32-bit) ◇ Vista Premium logo					
Memory	1GB or 2GB std / 4GB max ⁷ / PC3-8500 1066MHz DDR3 , non-parity, dual-channel capable, two 204-pin SO-DIMM sockets; <i>Italics:</i> standard memory in both sockets; no sockets available; <i>Non-italics:</i> standard memory in one socket; one socket available										Preloaded applications¹⁴ (all OSes) • Rescue and Recovery™ • Access Connections™ • Client Security Solution™ • ThinkVantage Productivity Center • ThinkVantage System Update • McAfee VirusScan® Plus with SiteAdvisor™ (30 days of virus definitions) • PC-Doctor™ (diagnostics) • ThinkPad Utilities (Power Manager and Presentation Director) • Adobe® Reader • Windows Live™ Toolbar • Windows Live Search • Fingerprint Software (fingerprint models) • Microsoft Office 2007 Trial (60-day) • Roxio® Creator® Business Edition • Roxio MyDVD® (DVD±RW)					
SATA Combo SATA DVD±RW Ultrabay Enhanced SATA disk	Some: DVD-ROM/CD-RW, SATA 1.5Gb/s, 12.7mm Ultrabay Enh, removable (43R9148) Some: DVD burner, SATA 1.5Gb/s, 12.7mm Ultrabay Enhanced, removable (43R9149) One bay for removable devices, Ultrabay Slim-compatible, 12.7mm high 80GB⁸ (5400 rpm) or 160GB (5400 rpm) / SATA 1.5Gb/s, 2.5" wide, 9.5mm high, removable, upgradable, supports 2nd disk, ThinkPad Shock Mounted Hard Drive, Active Protection System™															
Widescreen display Camera	15.4" (391mm) WXGA (1280x800) color , anti-glare, CCFL backlight, 185 nits, 16:10 aspect ratio, 300:1 contrast ratio <i>Some:</i> camera on top of screen, 1.3-megapixel, fixed focus															
Integrated graphics	Intel Graphics Media Accelerator 4500MHD (GMA 4500MHD) , in GM45, digital monitor support via DisplayPort (supports single-link DVI-D via cable 45J7915); <i>Maximum external resolution:</i> 2048x1536@75Hz															
Keyboard TrackPoint® Touch pad ThinkLight™	89-key, ThinkVantage button, spill-resistant, multimedia Fn keys TrackPoint® pointing device, "Press-to-Select," Internet Scroll Bar ¹³ , magnifying glass UltraNav™, wide touch pad below keyboard, Tap Zones, scrolling regions label Illuminates the keyboard to improve visibility in low-light conditions															
Dimensions ³ Weight ² Case	<i>6-cell 15.4W"</i> (WxDxH): 14.1" x 10.2" x 1.4–1.5"; 358.6mm x 260mm x 36–39mm <i>6-cell:</i> starting at 6.4 lb (2.93kg) <i>Color:</i> black; <i>Material:</i> PolyCarbonate/Acrylonitrile-Butadiene-Styrene (PC/ABS) plastic															
Battery - type Battery - life ¹⁰	Lithium Ion 6-cell or 9-cell , supports unique 2nd battery in Ultrabay Enhanced <i>6-cell:</i> up to 4.5 hr; <i>6-cell plus Ultrabay battery:</i> up to 6.0 hr; <i>9-cell:</i> up to 7.1 hr															
Chipset	Mobile Intel GM45 Express Chipset (Graphics Memory Controller Hub), ICH9M I/O Controller Hub (SATA 3.0Gb/s, USB 2.0, PCI Express® 1.1, PCI 2.3, security chip, ethernet MAC), LPC bus (WPCN385 Super I/O)															
ExpressCard/54 PC Card Smart Card Reader Multicard Reader Ports	One slot (ExpressCard/34, ExpressCard/54) One slot (Type I, Type II), CardBus 32-bit None 7-in-1 reader (MMC, Memory Stick, Mem Stick Pro, SD, SDHC, XD, XD Type H) Three USB 2.0, external monitor (VGA DB-15, DisplayPort), modem (RJ-11), ethernet (RJ-45), IEEE 1394 FireWire 400 (4-pin connector; 1394a-2000 standard)															
Mini PCI Express Intel 5100 ²⁸ 2G Turbo WWAN UWB Modem Bluetooth™ Ethernet Intel AMT Audio support	Two Mini PCI Express slots 11a/b/g/n wireless ⁴ , Mini PCIe adapter, Intel WiFi Link 5100, 1x2 (Shirley Peak) None Not supported Not supported 56K V.92 ⁶ modem <i>Some:</i> Bluetooth 2.0 wireless, LED indicator Gigabit ethernet, Broadcom® BCM5787M (MAC/PHY), PCIe x1, PXE None High Definition (HD) Audio, AD1984HD codec / stereo speakers, 1 watt / volume up, down, mute buttons / digital microphone, microphone input jack, headphone jack															
Security Security chip Fingerprint reader	Power-on password, hard disk password, supervisor password, security keyhole Trusted Platform Module, integrated in ICH9M, TCG 1.2-compliant <i>Some:</i> Fingerprint reader on palm rest, swipe sensor, supports the security chip										Supports ThinkVantage® technologies					
Limited warranty ¹²	3-years/1-year battery, limited onsite service²⁴ , 8 am - 5 pm, Mon - Fri coverage excluding holidays, next business day response time / service upgrades ²² available										65-watt (GMA graphics) AC adapter ThinkPad Roll Cage (one-piece magnesium frame) EPEAT™ Silver rating ENERGY STAR® 4.0-compliant RoHS-compliant International Warranty Service ¹⁷ 24 hour x 7 day ¹⁸ toll-free support during the warranty period ¹² via 800-426-7378					
1GB PC3-8500 DDR3 SODIMM 2GB PC3-8500 DDR3 SODIMM Blu-ray Burner Ultrabay Enhanced SATA Serial ATA Hard Drive Bay Adapter II SATA 64GB SSD SATA 3.0Gb/s 1.8" (2.5" cover) 320GB Disk SATA 1.5Gb/s (5400 rpm) USB 2.0 Essential Memory Key 32GB USB 2.0 Ultra Secure Memory Key 8GB USB 2.0 Super Multi-Burner Drive ThinkPad Adjustable Notebook Stand ThinkPad Advanced Dock Other accessories on O-R500 sheet	43R1987 43R1988 43R9150 43R1980 43N3400 43N3403 45K1258 45J5918 41N5565 40Y7676 250310U	T/R/W/SL Series Li-Ion Battery 6-cell T/R/W/SL Series Li-Ion Battery 9-cell Advanced Ultrabay Battery II 3-cell 90W Slim AC/DC Combo Adapter ThinkPad Business Topload Case ThinkPad Business Backpack ThinkPad Deluxe Expander Case T500/R500/W500 15W Privacy Filter ThinkVision® L1940p Wide 19" Monitor ThinkVision L2240p Wide 22" Monitor ThinkVision L2440x Wide 24" Monitor Other accessories at lenovo.com/accessories	40Y6799 40Y6797 43R9250 41N8460 43R2476 43R2482 43R2478 43R2474 4424HB6 4422HB6 4421HB2	ThinkPlus™.22 4-year LOR 9x5 NBD 12X5630 Post-warranty annual maintenance agreements at lenovo.com/thinkplus/warranty												

See footnotes for important warranty information

Intel Centrino® 2 processor technology

US model announced September 2, 2008; previous models on August 5, 2008

© Lenovo

(WKK3-3) September 2008

ThinkPad® R500 2716 (Education)

Type-model	Processor	GHz	Memory	Wide-screen display	Camera	Integrated graphics	Disk SATA GB ⁵ rpm	SATA optical	Mini PCIe 802.11 wireless	Mini PCIe Turbo	Finger print reader	Battery Blue-tooth cells	Workhorse (W) Global (G) Avail date
2716-ECU	Cel 575	2.00	1GB	15.4" WXGA	Cam	GMA	80G 5400	Combo	Intel 5100 ²⁸	None	Finger	Blue 6	Bus 32 No Sep 08
2716-5PU	P8400	2.26	1GB	15.4" WXGA	Cam	GMA	80G 5400	Combo	Intel 5100	None	Finger	Blue 6	Bus 32 No Aug 08
2716-5QU	T9400	2.53	2GB	15.4" WXGA	Cam	GMA	160G 5400	DVD±RW	Intel 5100	None	Finger	Blue 6	Bus 32 No Aug 08

• **These models have an EasyServ™¹⁹ depot repair service 3-year limited warranty**

Educational models are available only to public or private K-12 or higher accredited schools organized and operated exclusively for educational purposes for use by qualified students and teachers.

Positioning Processor	Mainstream business performance; two spindles Intel® Celeron® Processor 575 with single-core, 667MHz system bus, and 1MB L2 cache Intel Core™ 2 Duo processor P8400 or T9400 with dual-core, Intel HD Boost, 1066MHz system bus; P8400: 3MB L2 cache; T9400: 6MB L2 cache										Preloaded operating system²⁰ - Microsoft® Windows® Vista® Business Edition (32-bit) ◇ Vista Premium logo		
Memory	2GB std / 4GB max ⁷ / PC3-8500 1066MHz DDR3 , non-parity, dual-channel capable, two 204-pin SO-DIMM sockets; <i>Italics:</i> standard memory in both sockets; no sockets available; <i>Non-italics:</i> standard memory in one socket; one socket available										Preloaded applications¹⁴ • Education software - Microsoft Office OneNote® 2007 (and CD) - VitalSource Library College Edition - Adobe® Instructor Resource Cntr - Adobe Digital School Collection – Photoshop Elements (and CD) – Premier Elements (and DVD) – Acrobat 8 Professional – Contribute 4 • Rescue and Recovery™ • Access Connections™ • Client Security Solution™ • ThinkVantage Productivity Center • ThinkVantage System Update • McAfee VirusScan® Plus with SiteAdvisor™ (30 days of virus definitions) • PC-Doctor™ (diagnostics) • ThinkPad Utilities (Power Manager and Presentation Director) • Adobe® Reader • Windows Live™ Toolbar • Windows Live Search • Fingerprint Software (fingerprint models) • Microsoft Office 2007 Trial (60-day) • Roxio® Creator® Business Edition • Roxio MyDVD® (DVD±RW)		
SATA Combo SATA DVD±RW Ultrabay Enhanced SATA disk	<i>Some:</i> DVD-ROM/CD-RW, SATA 1.5Gb/s, 12.7mm Ultrabay Enh, removable (43R9148) <i>Some:</i> DVD burner, SATA 1.5Gb/s, 12.7mm Ultrabay Enhanced, removable (43R9149) One bay for removable devices, Ultrabay Slim-compatible, 12.7mm high 80GB⁸ (5400) or 160GB (5400 or 7200 rpm) / SATA 1.5Gb/s, 2.5" wide, 9.5mm high, removable, upgradable, supports 2nd disk, ThinkPad Shock Mounted Hard Drive, Active Protection System™												
Widescreen display Camera	15.4" (391mm) WXGA (1280x800) color , anti-glare, CCFL backlight, 185 nits, 16:10 aspect ratio, 300:1 contrast ratio Camera on top of screen, 1.3-megapixel, fixed focus												
Integrated graphics	Intel Graphics Media Accelerator 4500MHD (GMA 4500MHD) , in GM45, digital monitor support via DisplayPort (supports single-link DVI-D via cable 45J7915); <i>Maximum external resolution:</i> 2048x1536@75Hz												
Keyboard TrackPoint® Touch pad ThinkLight™	89-key, ThinkVantage button, spill-resistant, multimedia Fn keys TrackPoint® pointing device, "Press-to-Select," Internet Scroll Bar ¹³ , magnifying glass UltraNav™, wide touch pad below keyboard, Tap Zones, scrolling regions label Illuminates the keyboard to improve visibility in low-light conditions												
Dimensions ³ Weight ² Case Battery - type Battery - life ¹⁰	<i>6-cell 15.4W"</i> (WxDxH): 14.1" x 10.2" x 1.4–1.5"; 358.6mm x 260mm x 36–39mm <i>6-cell:</i> starting at 6.4 lb (2.93kg) <i>Color:</i> black; <i>Material:</i> PolyCarbonate/Acrylonitrile-Butadiene-Styrene (PC/ABS) plastic Lithium Ion 6-cell , supports unique 2nd battery in Ultrabay Enhanced <i>6-cell:</i> up to 4.5 hr; <i>6-cell plus Ultrabay battery:</i> up to 6.0 hr; <i>9-cell:</i> up to 7.1 hr												
Chipset	Mobile Intel GM45 Express Chipset (Graphics Memory Controller Hub), ICH9M I/O Controller Hub (SATA 3.0Gb/s, USB 2.0, PCI Express® 1.1, PCI 2.3, security chip, ethernet MAC), LPC bus (WPCN385 Super I/O) One ExpressCard/34 or ExpressCard/54												
ExpressCard slot PC Card Std slot Smart Card Read Multicard Reader Ports	One ExpressCard/34 or ExpressCard/54 One Type I or Type II slot, CardBus 32-bit None 7-in-1 reader (MMC, Memory Stick, Mem Stick Pro, SD, SDHC, XD, XD Type H) Three USB 2.0, external monitor (VGA DB-15, DisplayPort), modem (RJ-11), ethernet (RJ-45), IEEE 1394 FireWire 400 (4-pin connector; 1394a-2000 standard)												
Mini PCI Express	Two Mini PCI Express slots 11a/b/g/n wireless ⁴ , Mini PCIe adapter, Intel WiFi Link 5100, 1x2 (Shirley Peak) 2G Turbo None WWAN Not supported UWB Not supported Modem 56K V.92 ⁶ modem Bluetooth™ Bluetooth 2.0 wireless, LED indicator Ethernet Gigabit ethernet, Broadcom® BCM5787M (MAC/PHY), PCIe x1, PXE Intel AMT None Audio support High Definition (HD) Audio, AD1984HD codec / stereo speakers, 1 watt / volume up, down, mute buttons / digital microphone, microphone input jack, headphone jack										Supports ThinkVantage® technologies		
Security Security chip Fingerprint reader	Power-on password, hard disk password, supervisor password, security keyhole Trusted Platform Module, integrated in ICH9M, TCG 1.2-compliant Fingerprint reader on palm rest, swipe sensor, supports the security chip										65-watt (GMA graphics) AC adapter ThinkPad Roll Cage (one-piece magnesium frame) EPEAT™ Silver rating ENERGY STAR® 4.0-compliant RoHS-compliant International Warranty Service ¹⁷ 24 hour x 7 day ¹⁸ toll-free support during the warranty period ¹² via 800-426-7378		
Limited warranty ¹²	3-years/1-yr battery - EasyServ™¹⁹ depot repair service / service upgrades²² available										ThinkPlus™. ²² 2-year LOR 9x5 NBD 41C9175 ThinkPlus 3-year LOR 9x5 NBD 41C9176 ThinkPlus 4-year LOR 9x5 NBD 40Y6799 ThinkPlus 5-year LOR 9x5 NBD 41N8460 ThinkPlus 4-year P&L P/U Depot 41C9178 ThinkPlus 5-year P&L P/U Depot 41C9180 Post-warranty annual maintenance agreements at lenovo.com/thinkplus/warranty		
1GB PC3-8500 DDR3 SODIMM	43R1987		T/R/W/SL Series Li-Ion Battery 6-cell		40Y6799								
2GB PC3-8500 DDR3 SODIMM	43R1988		T/R/W/SL Series Li-Ion Battery 9-cell		40Y6797								
Serial ATA Hard Drive Bay Adapter II SATA	43R1980		Advanced Ultrabay Battery II 3-cell		43R9250								
320GB Disk SATA 1.5Gb/s (5400 rpm)	43N3403		90W Slim AC/DC Combo Adapter		41N8460								
USB 2.0 Security Memory Key 4GB	41U5120		ThinkPad Business Topload Case		43R2476								
USB 2.0 Ultra Secure Memory Key 8GB	45J5918		ThinkPad Business Backpack		43R2482								
USB 2.0 Super Multi-Burner Drive	41N5565		ThinkPad Deluxe Expander Case		43R2478								
ThinkPad Adjustable Notebook Stand	40Y7676		T500/R500/W500 15W Privacy Filter		43R2474								
ThinkPad Advanced Dock	250310U		ThinkVision® L2440p Wide 24" Monitor		4420HB2								
Other accessories on O-R500 sheet			Other accessories at lenovo.com/accessories										

See footnotes for important warranty information

◇ Intel Centrino® 2 processor technology

© Lenovo

ES US model announced September 30, 2008; previous models on August 5, 2008

(WKK3-4) September 2008

Partial list of accessories supported on:

- ThinkPad R500 originally announced on August 5, 2008

Memory

1GB PC3-8500 DDR3 SODIMM (TopSeller)	43R2045	ann	11/04/08
1GB PC3-8500 DDR3 SODIMM	43R1987	ann	08/05/08
2GB PC3-8500 DDR3 SODIMM (TopSeller)	43R2046	ann	11/04/08
2GB PC3-8500 DDR3 SODIMM	43R1988	ann	08/05/08

Ultrabay Slim 9.5mm

Serial ATA Hard Drive Bay Adapter II SATA ⁴⁸	43R1980	ann	08/05/08
DVD-ROM Ultrabay Slim SATA 1.5Gb/s ⁴⁸	43N3212	ann	08/05/08
CD-RW/DVD-ROM Ultrabay Slim SATA ⁴⁸	43N3213	ann	08/05/08
DVD Burner Ultrabay Slim SATA 1.5Gb/s ⁴⁸	43N3214	ann	08/05/08
Blu-ray™ Burner Ultrabay Slim SATA 1.5Gb/s ⁴⁸	43N3215	ann	08/05/08

⁴⁸ Slim 9.5mm device in 12.7mm bay shows gap above the device.

Ultrabay Enhanced 12.7mm

DVD-ROM Ultrabay Enhanced SATA 1.5Gb/s	43R9147	ann	08/05/08
CD-RW/DVD-ROM Ultrabay Enh SATA	43R9148	ann	08/05/08
DVD Burner Ultrabay Enh SATA 1.5Gb/s	43R9149	ann	08/05/08
Blu-ray™ Burner Ultrabay Enh SATA 1.5Gb/s	43R9150	ann	08/05/08

Storage and removable storage

160GB Disk SATA 1.5Gb/s (5400 rpm) ⁴¹	41N5692	ann	03/20/07
160GB Disk SATA 1.5Gb/s (7200 rpm) ⁴¹	41N5737	ann	10/16/07
200GB Disk FDE SATA 1.5Gb/s (7200 rpm) ⁴¹	41N5738	ann	10/16/07
250GB Disk SATA 1.5Gb/s (5400 rpm) ⁴¹	43R8152	ann	01/15/08
320GB Disk SATA 1.5Gb/s (5400 rpm) ⁴¹	43N3403	ann	08/05/08

⁴¹ Can be used as the main HDD or with *Serial ATA Hard Drive Bay Adapter 43R1980* in the Ultrabay or (in the *ThinkPad Advanced Dock 250310U* with *Serial Hard Drive Ultrabay Slim Adapter 40Y8725*)

128GB SSD SATA 3.0Gb/s 1.8" (2.5" cover)	43N3406	ann	08/26/08
USB 2.0 Essential Memory Key 8GB	45J7905	ann	07/15/08
USB 2.0 Essential Memory Key 32GB	45K1258	ann	10/28/08
USB 2.0 Security Memory Key 4GB	41U5120	ann	07/17/07
USB 2.0 Ultra Secure Memory Key 2GB	45J5916	ann	08/26/08
USB 2.0 Ultra Secure Memory Key 4GB	45J5917	ann	08/26/08
USB 2.0 Ultra Secure Memory Key 8GB	45J5918	ann	08/26/08
USB Portable Diskette Drive	05K9276	ann	06/05/00
USB 2.0 CD-RW/DVD-ROM Combo II Drive	40Y8637	ann	01/05/06
USB 2.0 Portable 160GB Hard Disk	43R1784	ann	09/23/08
USB 2.0 Portable Secure 160GB Hard Disk	43R2018	ann	11/18/08
USB 2.0 Portable Secure 320GB Hard Disk	43R2019	ann	11/18/08
USB 2.0 Super Multi-Burner Drive	41N5565	ann	01/23/07

ThinkPad Expansion

USB 2.0 Lenovo Enhanced Port Replicator	43R8770	ann	02/26/08
ThinkPad Adjustable Notebook Stand	40Y7676	ann	09/20/05
ThinkPad Essential Port Replicator	250510W	ann	09/20/05
ThinkPad Advanced Mini Dock	250410U	ann	09/20/05
ThinkPad Advanced Dock	250310U	ann	09/20/05

Keyboard

TrackPoint Cap Collection	73P2698	ann	12/16/03
USB Numeric Keypad	33L3225	ann	05/01/00
Preferred Pro USB Keyboard	73P5220	ann	06/21/05
Enhanced Performance USB Keyboard	73P2620	ann	03/23/04
Wireless Kybd & Opt Wheel Mouse (via USB)	73P4067	ann	12/07/04
USB Keyboard with UltraNav	31P8950	ann	01/28/03
USB Travel Keyboard with UltraNav	31P9490	ann	04/27/04
Lenovo USB Fingerprint Keyboard	73P4730	ann	02/22/05

Mouse

Optical Wheel Mouse (USB)	06P4069	ann	05/21/03
Optical ScrollPoint® Mouse (USB, PS/2)	31P7405	ann	08/27/02
Optical Wheel Travel Mouse (USB, PS/2)	31P7410	ann	06/04/02
Laser Tilt Wheel Mouse (USB, PS/2)	41U3074	ann	01/23/07
Lenovo Wireless Laser Mouse (blk, via USB)	45K1696	ann	11/25/08
Lenovo Wireless Laser Mouse (red, via USB)	51J0198	ann	11/25/08
Laser Tilt Wheel Travel Mouse (Bluetooth)	41U5008	ann	01/22/08

Security

Kensington® Cable Lock from Lenovo	73P2582	ann	12/29/03
Kensington Twin Head Cable Lock	45K1620	ann	09/30/08
T500/R500/W500 Series 15W Privacy Filter	43R2474	ann	08/05/08
USB Gemplus GemPC Smart Card Reader	41N3040	ann	02/21/06
PC Card Gemplus Smart Card Reader	41N3004	ann	12/13/05
ExpressCard Gemplus Smart Card Reader	41N3043	ann	06/27/06

Multimedia

USB 2.0 Lenovo Multimedia Headset	40Y8518	ann	06/27/06
USB 2.0 Lenovo Webcam	40Y8519	ann	08/29/06

Batteries

T/R/W/SL Series Li-Ion Battery 6-cell	40Y6799	ann	01/05/06
T/R/W/SL Series Li-Ion Battery 9-cell	40Y6797	ann	09/20/05
Advanced Ultrabay Battery II 3-cell ⁴³	43R9250	ann	04/22/08

⁴³ Used in Ultrabay Slim bay.

ThinkPad External Battery Charger ⁴⁴	40Y7625	ann	09/20/05
---	---------	-----	----------

⁴⁴ Requires the *ThinkPad 90W AC Adapter 40Y7659* (adapter provided with some systems).

More information at www.lenovo.com/alldaycomputing

ThinkPad 65W AC Adapter ⁴⁵	40Y7696	ann	01/05/06
⁴⁵ Only compatible with the GM45 chipset models.			
ThinkPad 90W AC Adapter	40Y7659	ann	09/20/05
ThinkPad 90W Slim AC/DC Combo Adapter	41N8460	ann	11/27/07

More info at www.lenovo.com/support/poweradapters

Charging tips for 90W Slim AC/DC Combo Adapter 41N8460

• Dual (ThinkPad+Phone) Charging Y-Cable	41R4345	ann	12/18/07
• Palm device charge tip (L7)	41R4315	ann	12/18/07
• BlackBerry charge tip (L8a)	41R4478	ann	12/18/07
• iPod and iPhone charge tip (L10a)	41R4481	ann	12/18/07

More information at www.lenovo.com/support/slimadaptertips

Carrying Cases

<i>Up to 15.4" widescreen models:</i>			
Lenovo Carrying Case - Messenger Max	41U5253	ann	05/01/07
Lenovo Carr Case - Performance Backpack	41U5254	ann	05/01/07
Lenovo Standard Case	45K1697	ann	11/25/08
Lenovo Standard Backpack	45K1698	ann	11/25/08
ThinkPad Business Topload Case	43R2476	ann	05/13/08
ThinkPad Business Backpack	43R2482	ann	05/13/08
ThinkPad Deluxe Expander Case	43R2478	ann	05/13/08
ThinkPad Executive Leather Case	43R2480	ann	05/13/08

<i>Up to 17.0" widescreen models:</i>			
ThinkPad 17W Business Topload Case	43R9117	ann	08/12/08

Lenovo luxury cases at www.lenovoluxurycases.com

Monitors

ThinkVision® L174 17" Monitor	9227AE1	ann	04/15/08
ThinkVision L1700p 17" Monitor	9417HE2	ann	09/17/08
ThinkVision L1900p 19" Monitor	4431HE1	ann	11/11/08
ThinkVision L1940p Wide 19" Monitor	4424HB6	ann	09/17/08
ThinkVision L200p Wide 20.1" Monitor	4438HB6	ann	04/15/08
ThinkVision L2240p Wide 22" Monitor	4422HB6	ann	09/17/08
ThinkVision L2440p Wide 24" Monitor	4420HB2	ann	09/17/08
ThinkVision L2440x Wide 24" Monitor	4421HB2	ann	09/17/08

Monitor Accessories⁴⁶

DisplayPort to Single-link DVI-D Cable	45J7915	ann	08/05/08
ThinkVision USB Soundbar	40Y7616	ann	08/23/05
ThinkVision Soundbar	45K1263	ann	09/16/08
Kensington Cable Lock from Lenovo	73P2582	ann	12/29/03
Kensington Twin Head Cable Lock	45K1620	ann	09/30/08
ThinkPad Convertible Monitor Stand	40Y7620	ann	05/05/06
Radial Arm	19K4464	ann	05/05/00

⁴⁶ Compatible on selected Lenovo and ThinkVision monitors.

More information at www.lenovo.com/support/monitoraccessories

Other accessories at www.lenovo.com/accessories

Accessories Guide pdf at www.lenovo.com/accessoriesguide

ThinkPad® T61 14W 7658 (GMA) - TopSeller

Personal Systems Reference (PSREF)

Type-model	Processor	GHz	Memory	Wide-screen display	Graphics controller	Disk SATA GB ⁸ rpm	EIDE optical	Mini PCIe 802.11 wireless	Mini PCIe WWAN or Turbo	Card slot	Blue-tooth	Finger-print reader	Bat-tery cells	Whorse (W) Gbl (G) Educ	Avail date
7658-15U T7100	1.80	1GB	14.1" WXGA	GMA	80G 5400	DVD±RW	* Intel 11a/b/g ³²	/54	Finger	4	Bus32	May07			
7658-01U T7100	1.80	1GB	14.1" WXGA	GMA	80G 5400	DVD±RW	* Intel 11a/b/g	/54	Finger	4	XP Pro	July07			
7658-02U T7300	2.00	1GB	14.1" WXGA	GMA	120G 5400	DVD±RW	* Intel 11a/b/g	/54	Blue	Finger	4	Bus32	July07		
7658-03U T7300	2.00	1GB	14.1" WXGA	GMA	120G 5400	DVD±RW	* Intel 11a/b/g	/54	Blue	Finger	4	XP Pro	July07		
7658-04U T7250	2.00	1GB	14.1" WXGA	GMA	100G 7200	Combo	* Intel 11a/b/g	/54	Blue	Finger	4	XP Pro	Dec07		
7658-17U T7500	2.20	1GB	14.1" WXGA	GMA	160G 5400	DVD±RW	* Intel 11n ²⁸	1G Turbo /54	Blue	Finger	4	Bus32	Oct 07		
7658-18U T7500	2.20	1GB	14.1" WXGA	GMA	160G 5400	DVD±RW	* Intel 11n	/54	Blue	Finger	4	XP Pro	Oct 07		
7658-RUU T8100	2.10	1GB	14.1" WXGA	GMA	120G 5400	DVD±RW	* Intel 11a/b/g	/54	Finger	4	XP Pro	Jan 08			
7658-RVU T8100	2.10	1GB	14.1" WXGA	GMA	100G 7200	DVD±RW	* Intel 11n	/54	Blue	Finger	4	XP Pro	Jan 08		
7658-19U T5270	1.40	1GB	14.1" WXGA	GMA	100G 7200	Combo	* Intel 11a/b/g	/54			4	Bus32	Apr 08		
7658-NKU T8100	2.10	2GB	14.1" WXGA	GMA	160G 5400	DVD±RW	* Intel 11a/b/g	/54		Finger	4	Bus32	Apr 08		
7658-NLU T8100	2.10	2GB	14.1" WXGA	GMA	100G 7200	DVD±RW	* Intel 11n	/54	Blue	Finger	4	Bus32	Apr 08		
7658-05U T8300	2.40	2GB	14.1" WXGA	GMA	100G 7200	DVD±RW	* Intel 11n	4-in-1	Blue	Finger	6	Bus32	Educ May08		

- These small and medium business (SMB) models are part of the US TopSeller™ Program
- These models have a 1-year limited warranty¹²

Processor	Intel® Core™ 2 Duo processor T5270 with dual-core, Intel 64 Technology, Enhanced Intel SpeedStep® technology ¹ , Intel Dynamic Acceleration, Execute Disable Bit, 800MHz system bus, and 2MB shared L2 cache or Intel® Core™ 2 Duo processor T7100, T7250, T7300, T7500, T8100, or T8300 with dual-core, Intel 64 Technology, Enhanced Intel SpeedStep® technology ¹ , Intel Dynamic Acceleration, Execute Disable Bit, Virtualization Technology, and 800MHz system bus; T7100/T7250: 2MB L2 cache; T7300/T7500: 4MB L2; T8100/T8300: 3MB L2 cache	Preloaded operating system ²⁰ - Some: Microsoft® Windows® XP Professional with Vista® COA - Some: Microsoft Windows Vista Business Edition (32-bit) ◇ 02U/17U/19U: Vista Basic logo ◇ 05U/15U/NKU/NLU: Vista Premium logo
Memory	1GB or 2GB std / 4GB max ⁷ / PC2-5300 667MHz DDR2, non-parity, dual-channel capable, two 200-pin SO-DIMM sockets; <i>Italics:</i> standard memory in both sockets; no sockets available; <i>Non-italics:</i> standard memory in one socket; one socket available	Preloaded applications ¹⁴ (all OSes; only some listed) • Microsoft Office OneNote® 2007 and CD (05U model) • Some: Education software - VitalSource Library College Edition - Adobe® Instructor Resource Cntr - Adobe Digital School Collection - Photoshop Elements (and CD) - Premier Elements (and DVD) - Acrobat 8 Professional - Contribute 4 • Rescue and Recovery™ • ThinkPad Utilities • Some: Fingerprint Software • Microsoft Office 2007 Trial (60-day) • Sonic RecordNow and Drive Letter Access (DVD±RW) • Corel® WinDVD® (DVD±RW) • Corel WinDVD Creator (XP Pro DVD±RW models)
Diskette drive	None (use optional USB-based diskette drive)	Supports ThinkVantage® technologies 65-watt (GMA graphics) AC adapter ThinkPad Roll Cage and Top Cover Roll Cage (one-piece magnesium) ENERGY STAR® 4.0-compliant RoHS-compliant International Warranty Service ¹⁷ 24 hour x 7 day ¹⁸ toll-free support during the warranty period ¹² via 800-426-7378
EIDE Combo	Some: DVD-ROM/CD-RW, 24X/24X/24X/8X ²¹ speed, removable from Ultrabay Slim	
EIDE DVD±RW	Some: DVD burner, Super Multi-Burner (40Y8623) dual-layer, removable from Ultrabay	
Ultrabay Slim	One modular bay for interchangeable devices (right side), 9.5mm high bay, flat bezel	
Serial ATA disk	80GB ⁸ (5400 rpm), 100GB (7200 rpm), 120GB (5400 rpm), or 160GB (5400 rpm) / SATA 1.5Gb/s, 9.5mm high, removable, upgradable, 9.5mm high bay, supports 2nd disk, ThinkPad Shock Mounted Hard Drive, Active Protection System™	
Widescreen display	14.1" (358.1mm) WXGA (1280x800) color, anti-glare, 185 nits, 16:10 aspect ratio, 300:1 contrast ratio	
Camera	None	
Graphics	Intel Graphics Media Accelerator X3100 (GMA X3100), integrated in GM965, DVI pass-through support to optional Advanced Mini Dock or Advanced Dock	
Keyboard	89-key, ThinkVantage button, spill-resistant, multimedia Fn keys, Windows/Apl keys	
TrackPoint®	TrackPoint® pointing device, "Press-to-Select," Internet Scroll Bar ¹³ , magnifying glass	
Touch pad	UltraNav™ multi-pointing system, touch pad below keyboard, Tap Zones	
ThinkLight™	Illuminates the keyboard to improve visibility in low-light conditions	
Dimensions ³	4-cell 14.1W" (WxDxH): 13.2" x 9.3" x 1.09–1.26"; 335mm x 237mm x 27.6–31.9mm	
Weight ²	4-cell: starting at 5.0 lb (2.3kg)	
Case material	Top: Super-Elastic PolyCarbonate (SEPC); Bottom: Carbon-Fiber Reinforced Plastic	
Battery - type	Lithium Ion 4-cell or 6-cell, supports unique 2nd battery in Ultrabay Slim	
Battery - life ¹⁰	4-cell: up to 3.6 hr; 6-cell: up to 5.7 hr; 6-cell plus Ultrabay battery: up to 7.2 hr	
Chipset	Mobile Intel GM965 Express Chipset (Graphics Memory Controller Hub); ICH8M-Enhanced I/O Controller Hub (SATA 3.0Gb/s, ATA-100 EIDE, PCI Express [®] x1, PCI bus, USB, LPC bus, [Bluetooth], [fingerprint]) / PCI bus (Ricoh® R5C847 Cardbus/1394/Multicard) / LPC bus (WPCN385 Super I/O, Atmel® 97SC3203 TPM)	
PC Card Std slot	One Type I or Type II slot, CardBus 32-bit	
ExpressCard slot	Some: [/54] One ExpressCard/34 or ExpressCard/54	
Smart Card Read	None	
Multicard Reader	Some: 4-in-1 reader (MultiMediaCard, Mem Stick PRO, Sec Digital, xD-Picture Card™)	
Ports	Three USB 2.0, DB-15 (external VGA monitor), RJ-11 (modem), RJ-45 (ethernet), IEEE 1394 FireWire 400 (4-pin connector; 1394a-2000 standard)	
Wireless antenna	UltraConnect™ II antenna / on-off switch for all wireless radios	
Mini PCI Express	Two Mini PCI Express slots / only 802.11 wireless is customer upgradable	
Intel 11a/b/g ³²	Some: 11a/b/g wireless ⁴ , Mini PCIe adapter, Intel PRO/Wireless 3945ABG	
Intel 11n ²⁸	Some: 11a/b/g/n wireless ⁴ , Mini PCIe adapter, Intel Wireless WiFi Link 4965AGN, MIMO 2x3 (Kedron)	
WWAN	None	
1G Turbo	Some: Intel Turbo Memory, Mini PCIe adapter, 1GB flash, disk-cache accelerator	
Modem	56K V.92 [®] modem in Communications Daughter Card socket	
Bluetooth™	Some: Bluetooth 2.0 wireless, USB 2.0 interface via ICH8M, LED indicator	
Ethernet	Gigabit ethernet, Intel 82566MM Nineveh (PHY), PCIe x1 (GLCI), PXE	
Intel AMT	Intel Active Management Technology (iAMT)	
Audio support	High Definition (HD) Audio, AD1984HD codec / stereo speakers, 1 watt / volume up, down, mute buttons / internal microphone, microphone input jack, headphone jack	
Security	Power-on password, hard disk password, supervisor password, security keyhole	
Security chip	Trusted Platform Module, Atmel chip, TCG 1.2-compliant	
Fingerprint reader	Fingerprint reader on palm rest, swipe sensor, supports the security chip	
Limited warranty ¹²	1-year - EasyServ™ ¹⁹ depot repair service / service upgrades ²² available	lenovo.com/thinkplus/warranty

See footnotes for important warranty information

* Intel Centrino® processor technology

US model announced May 15, 2008;

* Intel Centrino with vPro™ technology

previous models on May 9, July 6, October 30, December 6, 2007, January 8, or April 8, 2008

US models withdrawn effective December 2007 or June 2008

© Lenovo

(ML1-1) May 2008

ThinkPad® T61 14W 7664 (NVIDIA®) - TopSeller

Personal Systems Reference (PSREF)

Type-model	Processor	GHz	Memory	Wide-screen display	Camera	Graphics controller	Disk SATA GB ² rpm	EIDE optical	Mini PCIe 802.11 wireless	Mini PCIe WWAN or Turbo	Card slot	Blue-tooth	Battery cells	Whorse (W) Gbl (G) Educ	Avail date
7664-16U	T7300	2.00	1GB	14.1" WXGA+		128MB	120G 5400	DVD±RW	* Intel 11n ²⁸	1G Turbo	/54	Blue	6	Bus 32	May 07
7664-17U	T7300	2.00	2GB	14.1" WXGA+		128MB	160G 5400	DVD±RW	* Intel 11n	1G Turbo	/54	Blue	6	Ult 32	May 07
7664-04U	T7300	2.00	1GB	14.1" WXGA+		128MB	120G 5400	DVD±RW	* Intel 11n		/54	Blue	6	XP Pro	July 07
7664-05U	T7300	2.00	1GB	14.1" WXGA+		128MB	160G 5400	DVD±RW	* Intel 11n	Verizon	/54	Blue	6	XP Pro	July 07
7664-06U	T7500	2.20	1GB	14.1" WXGA+		128MB	100G 7200	DVD±RW	* Intel 11n		/54	Blue	4	XP Pro	Dec 07
7664-1JU	T7500	2.20	1GB	14.1" WXGA+		128MB	160G 5400	DVD±RW	* Intel 11n	1G Turbo	/54	Blue	6	Bus 32	Oct 07
7664-1KU	T7500	2.20	1GB	14.1" WXGA+		128MB	160G 5400	DVD±RW	* Intel 11n		/54	Blue	6	XP Pro	Oct 07
7664-1LU	T7700	2.40	2GB	14.1" WXGA+		128MB	160G 7200	DVD±RW	* Intel 11n	1G Turbo	/54	Blue	6	Bus 32	Oct 07
7664-RYU	T8100	2.10	1GB	14.1" WXGA+		128MB	100G 7200	DVD±RW	* Intel 11n		/54	Blue	6	XP Pro	Jan 08
7664-RWU	T8300	2.40	1GB	14.1" WXGA+		128MB	160G 5400	DVD±RW	* Intel 11n	Verizon	/54	Blue	6	XP Pro	Jan 08
7664-R8U	T8100	2.10	2GB	14.1" WXGA+		128MB	100G 7200	DVD±RW	* Intel 11n		/54	Blue	6	Bus 32	Apr 08
7664-R7U	T8300	2.40	2GB	14.1" WXGA+		128MB	160G 5400	DVD±RW	* Intel 11n	Verizon	/54	Blue	6	Bus 32	Apr 08
7664-01U	T5670	1.80	2GB	14.1" WXGA+	Cam	128MB	100G 7200	DVD±RW	* Intel 4965AG ³²		4-in-1	Blue	6	Bus 32 Educ	Aug 08

- These small and medium business (SMB) models are part of the US TopSeller™ Program
- These models have a 3-year limited warranty¹²

Processor	Intel® Core™ 2 Duo processor T5670, T7300, T7500, T7700, T8100, or T8300 with dual-core, 800MHz system bus, T5670: 2MB shared L2 cache; T7300/T7500/T7700: 4MB shared L2 cache; T8100/T8300: 3MB shared L2 cache	Preloaded operating system ²⁰
Memory	1GB or 2GB std / 4GB max ⁷ / PC2-5300 667MHz DDR2, non-parity, dual-channel capable, two 200-pin SO-DIMM sockets; <i>Italics:</i> standard memory in both sockets; no sockets available; <i>Non-italics:</i> standard memory in one socket; one socket available	- Some: Microsoft® Windows® XP Professional with Vista® COA - Some: Microsoft Windows Vista® Business Edition (32-bit) - Some: Microsoft Windows Vista Ultimate Edition (32-bit) ◇ Vista models: Vista Premium logo
Diskette drive	None (use optional USB-based diskette drive)	Preloaded applications ¹⁴ (all OSes; only some listed)
EIDE Combo	Some: DVD-ROM/CD-RW, 24X/24X/8X ²¹ speed, removable from Ultrabay Slim	• Some: Education software
EIDE DVD±RW	Some: DVD burner, Super Multi-Burner (40Y8623) dual-layer, removable from Ultrabay	- Microsoft Office OneNote® 2007 (and CD)
Ultrabay Slim	One modular bay for interchangeable devices (right side), 9.5mm high bay, flat bezel	- VitalSource Library College Edition
Serial ATA disk	100GB ⁸ (7200 rpm), 120GB ⁸ (5400 rpm), or 160GB ⁸ (5400 or 7200 rpm) / SATA 1.5Gb/s, 9.5mm high, removable, upgradable, 9.5mm high bay, supports 2nd disk, ThinkPad Shock Mounted Hard Drive, Active Protection System™	- Adobe® Instructor Resource Cntr - Adobe Digital School Collection - Photoshop Elements (and CD) - Premier Elements (and DVD) - Acrobat 8 Professional - Contribute 4
Widescreen display	14.1" (358.1mm) WXGA+ (1440x900) color, anti-glare, 200 nits, 16:10 aspect ratio, 300:1 contrast ratio	• Rescue and Recovery™
Camera	Some: camera on top of screen, 1.3-megapixel, fixed focus, USB 2.0	• Access Connections™
Graphics	NVIDIA® Quadro® NVS 140M, PCI Express® x16, 128MB memory, TurboCache, DVI pass-through support to optional Advanced Mini Dock or Advanced Dock	• Client Security Solution™
Keyboard	89-key, ThinkVantage button, spill-resistant, multimedia Fn keys, Windows/Appl keys	• ThinkVantage System Update
TrackPoint®	TrackPoint® pointing device, "Press-to-Select," Internet Scroll Bar ¹³ , magnifying glass	• Norton Internet Security™ (90 days of virus definitions)
Touch pad	UltraNav™ multi-pointing system, touch pad below keyboard, Tap Zones	• PC-Doctor™ (diagnostics)
ThinkLight™	Illuminates the keyboard to improve visibility in low-light conditions	• ThinkPad Utilities
Dimensions ³	6-cell 14.1W" (WxDxH): 13.2" x 10.2" x 1.09–1.26"; 335 x 261mm x 27.6–31.9mm	• FingerPrint Software
Weight ²	6-cell: starting at 5.3 lb (2.4kg)	• Microsoft Office 2007 Trial (60-day)
Case material	Top: Super-Elastic PolyCarbonate (SEPC); Bottom: Carbon-Fiber Reinforced Plastic	• EarthLink Trial (Vista Ultimate mod)
Battery - type	Lithium Ion 4-cell or 6-cell, supports unique 2nd battery in Ultrabay Slim	• Sonic RecordNow and Drive Letter Access (DVD±RW)
Battery - life ¹⁰	6-cell: up to 3.8 hr; 6-cell plus Ultrabay battery: up to 5.3 hr	• Corel® WinDVD® (DVD±RW)
Chipset	Mobile Intel PM965 Express Chipset (Memory Controller Hub); ICH8M-Enhanced I/O Controller Hub (SATA 3.0Gb/s, ATA-100 EIDE, PCI Express x1, PCI bus, USB, LPC bus, [Bluetooth], [fingerPrint]) / PCI bus (Ricoh® R5C847 Cardbus/1394/Multicard) / LPC bus (WPCN385 Super I/O, Atmel® 97SC3203 TPM)	• Corel WinDVD Creator (XP Pro DVD±RW models)
PC Card	One slot (Type I, Type II), CardBus 32-bit	Supports ThinkVantage® technologies
ExpressCard/54	Some: [/54] One slot (ExpressCard/34, ExpressCard/54)	90-watt (NVIDIA) AC adapter
Smart Card Read	None	ThinkPad Roll Cage and Top Cover
Multicard Reader	Some: 4-in-1 reader (MultiMediaCard, Mem Stick® PRO, Sec Digital, xD-Picture Card™)	Roll Cage (one-piece magnesium)
Ports	Three USB 2.0, DB-15 (external VGA monitor), RJ-11 (modem), RJ-45 (ethernet), IEEE 1394 FireWire 400 (4-pin connector; 1394a-2000 standard)	ENERGY STAR® 4.0-compliant
Wireless antenna	UltraConnect™ II antenna / on-off switch for all wireless radios	RoHS-compliant
Mini PCI Express	Two Mini PCI Express slots / only 802.11 wireless is customer upgradable	International Warranty Service ¹⁷
Intel 4965AG ³²	Some: 11a/b/g wireless ⁴ , Mini PCIe adapter, Intel Wireless WiFi Link 4965AG	24 hour x 7 day ¹⁸ toll-free support during the warranty period ¹² via 800-426-7378
Intel 11n ²⁸	Some: 11a/b/g/n wireless ⁴ , Mini PCIe adapter, Intel Wireless WiFi Link 4965AGN, MIMO 2x3 (Kedron)	ThinkPlus™.22 2-year LOR ²⁴ 9x5 NBD 41C9175
Verizon ¹⁶	Some: Wireless WAN, Sierra Wireless 1xEV-DO Network Adapter, Mini PCIe adapter, EV-DO Rev. A, service contract reqd with Verizon® Wireless	ThinkPlus 3-year LOR 9x5 NBD 41C9176
1G Turbo	Some: Intel Turbo Memory, Mini PCIe adapter, 1GB flash, disk-cache accelerator	ThinkPlus 4-year LOR 9x5 NBD 41C9177
Modem	56K V.92 ⁶ modem in Communications Daughter Card socket	ThinkPlus 5-year LOR 9x5 NBD 41C9179
Bluetooth™	Bluetooth 2.0 wireless, USB 2.0 interface via ICH8M, LED indicator	ThinkPlus 4-year P&L P/U Depot 41C9178
Ethernet	Gigabit ethernet, Intel 82566MM Nineveh (PHY), PCIe x1 (GLCI), PXE	ThinkPlus 5-year P&L P/U Depot 41C9180
Intel AMT	Intel Active Management Technology (iAMT)	Post-warranty annual maintenance agreements at lenovo.com/thinkplus/warranty
Audio support	High Definition (HD) Audio, AD1984HD codec / stereo speakers, 1 watt / volume up, down, mute buttons / internal microphone, microphone input jack, headphone jack	
Security	Power-on password, hard disk password, supervisor password, security keyhole	
Security chip	Trusted Platform Module, Atmel chip, TCG 1.2-compliant	
Fingerprint reader	Fingerprint reader on palm rest, swipe sensor, supports the security chip	
Limited warranty ¹²	3-years/1-yr battery - EasyServ depot repair service / service upgrades ²² available	
2GB PC2-5300 DDR2 SODIMM (TopSeller)	43R2000	
128GB SSD SATA 3.0Gb/s 1.8" (2.5" cover)	43N3406	
Other accessories on O-T61 sheet		
T/R 14W High Capacity Batt 9-cell	43R2499	
90W Slim AC/DC Combo Adapter	41N8460	
Other accessories at lenovo.com/accessories		

See footnotes for important warranty information

* Intel Centrino® with vPro™ technology

© Lenovo

US models announced August 1, 2008; previous models on May 9, Jul 6, Oct 30, Dec 6, 2007, Jan 8, or Apr 8, 2008

(ML1-2) August 2008

US models withdrawn effective Dec 2007, May 2008, or June 2008

ThinkPad® T61u 14W 7659 (GMA) - Education (EasyServ)

Personal Systems Reference (PSREF)

Proc- Type-model	essor GHz	Memory	Wide- screen display	Graphics controller	Cam- era	Disk SATA GB ⁸ rpm	EIDE optical	Mini PCIe 802.11 wireless	Mini PCIe WWAN or Turbo	Card slot	Blue- tooth	Finger print reader	Vista preload	Workhorse (W) Limited warranty ¹²	Gbl (G) Avail date
7659-N2U	T8300	2.40 1GB	14.1" WXGA	GMA	Cam 80G	5400 Combo		11a/b/g	None	4-in-1	Blue		Business32	EasyServ	No Feb 08
7659-N3U	T9300	2.50 1GB	14.1" WXGA	GMA	Cam 100G	7200 DVD±RW		11a/b/g	None	4-in-1	Blue	Fing	Business32	EasyServ	No Feb 08
7659-05U	T9300	2.50 2GB	14.1" WXGA	GMA	Cam 160G	7200 DVD±RW		11a/b/g	None	4-in-1	Blue	Fing	Business32	EasyServ	No Apr 08

Italic MTM: not a base model for building a custom model

• **These models have an EasyServ™.19 depot repair service 3-year limited warranty**

These educational models are available only to public or private K-12 or higher accredited schools organized and operated exclusively for educational purposes for use by qualified students and teachers.

Positioning Processor	<i>Premiere performance; two spindles</i> Intel® Core™ 2 Duo processor T8300 or T9300 with dual-core, Intel 64 Technology, Enhanced Intel SpeedStep technology ¹ , Intel Dynamic Acceleration, Execute Disable Bit, Virtualization Technology, 800MHz system bus; <i>T8300: 3MB L2 cache; T9300: 6MB shared L2 cache</i>											Preloaded operating system²⁰ - Microsoft® Windows® Vista® Business Edition (32-bit) ◇ Vista Basic logo			
Memory	1GB or 2GB std / 4GB max ⁷ / PC2-5300 667MHz DDR2, non-parity, dual-channel capable, two 200-pin SO-DIMM sockets; <i>Italics:</i> standard memory in both sockets; no sockets available; <i>Non-italics:</i> standard memory in one socket; one socket available											Preloaded applications¹⁴ • Microsoft Office OneNote® 2007 (and CD) • Education software - VitalSource Library College Edition - Adobe® Instructor Resource Cntr - Adobe Digital School Collection - Photoshop Elements (and CD) - Premier Elements (and DVD) - Acrobat 8 Professional - Contribute 4 • Rescue and Recovery™ • Access Connections™ • Client Security Solution™ • ThinkVantage Productivity Center • ThinkVantage System Update • System Migration Assistant • Norton Internet Security™ (90 days of virus definitions) • Diskeeper® Home • PC-Doctor™ (diagnostics) • ThinkPad Utilities (Power Manager and Presentation Director) • Adobe® Reader • Windows Live™ Toolbar • Windows Live Search • Picasa from Google • <i>Some:</i> Fingerprint Software • Microsoft Office 2007 Trial (60-day) • Sonic RecordNow and Drive Letter Access (combo, DVD±RW) • Corel® WinDVD® (combo, DVD±RW)			
Diskette drive	None (use optional USB-based diskette drive)														
EIDE Combo	<i>Some:</i> DVD-ROM/CD-RW, 24X/24X/24X/8X ²¹ speed, removable from Ultrabay Slim														
EIDE DVD±RW	<i>Some:</i> DVD burner, Super Multi-Burner (40Y8623) dual-layer, removable Ultrabay Slim														
Ultrabay Slim	One modular bay for interchangeable devices (right side), 9.5mm high bay, flat bezel														
Serial ATA disk	80GB⁸ (5400 rpm), 100GB (7200 rpm), or 160GB (7200 rpm) / SATA 1.5Gb/s, 9.5mm high, removable, upgradable, 9.5mm high bay, supports 2nd disk, ThinkPad Shock Mounted Hard Drive, Active Protection System™														
Widescreen display	14.1" (358.1mm) WXGA (1280x800) color , anti-glare, 185 nits, 16:10 aspect ratio, 300:1 contrast ratio														
Camera	Camera on top of screen, 1.3-megapixel, fixed focus, USB 2.0														
Graphics	Intel Graphics Media Accelerator X3100 (GMA X3100) , integrated in GM965, DVI pass-through support to optional Advanced Mini Dock or Advanced Dock														
Keyboard	89-key, ThinkVantage button, spill-resistant, multimedia Fn keys, Windows/Appl keys														
TrackPoint®	TrackPoint® pointing device, "Press-to-Select," Internet Scroll Bar ¹³ , magnifying glass														
Touch pad	UltraNav™ multi-pointing system, touch pad below keyboard, Tap Zones														
ThinkLight™	Illuminates the keyboard to improve visibility in low-light conditions														
Dimensions ³	<i>6-cell 14.1W" (WxDxH): 13.2" x 10.2" x 1.09–1.26"; 335 x 261mm x 27.6–31.9mm</i>														
Weight ²	<i>6-cell:</i> starting at 5.3 lb (2.4kg)														
Case material	<i>Top:</i> Super-Elastic PolyCarbonate (SEPC); <i>Bottom:</i> Carbon-Fiber Reinforced Plastic														
Battery - type	Lithium Ion 6-cell , supports unique 2nd battery in Ultrabay Slim														
Battery - life ¹⁰	<i>6-cell:</i> up to 5.7 hr; <i>6-cell plus Ultrabay battery:</i> up to 7.2 hr														
Chipset	Mobile Intel GM965 Express Chipset (Graphics Memory Controller Hub); ICH8M-Enhanced I/O Controller Hub (SATA 3.0Gb/s, ATA-100 EIDE, PCI Express® x1, PCI bus, USB, LPC bus, [Bluetooth], [fingerprint]) / PCI bus (Ricoh® R5C847 Cardbus/1394/Multicard) / LPC bus (WPCN385 Super I/O, Atmel® 97SC3203 TPM)														
PC Card	One slot (Type I, Type II), CardBus 32-bit, integrated door														
ExpressCard slot	None														
Smart Card Read	None														
Multicard Reader	4-in-1 reader (MultiMediaCard, Mem Stick PRO, Sec Digital, xD-Picture Card™)														
Ports	Three USB 2.0, DB-15 (external VGA monitor), RJ-11 (modem), RJ-45 (ethernet), IEEE 1394 FireWire 400 (4-pin connector; 1394a-2000 standard)														
Wireless antenna	UltraConnect™ II antenna / on-off switch for all wireless radios														
Mini PCI Express	Two Mini PCI Express slots / only 802.11 wireless is customer upgradable														
11a/b/g ³²	11a/b/g wireless ⁴ , ThinkPad 11a/b/g Mini PCIe Adapter, Atheros AR5006EX														
WWAN	None														
Turbo Memory	None														
Modem	56K V.92 ⁶ modem in Communications Daughter Card socket														
Bluetooth™	Bluetooth 2.0 wireless, USB 2.0 interface via ICH8M, LED indicator														
Ethernet	Gigabit ethernet, Intel 82566MM Nineveh (PHY), PCIe x1 (GLCI), PXE														
Intel AMT	Intel Active Management Technology (IAMT)														
Audio support	High Definition (HD) Audio, AD1984HD codec / stereo speakers, 1 watt / volume up, down, mute buttons / internal microphone, microphone input jack, headphone jack														
Security	Power-on password, hard disk password, supervisor password, security keyhole														
Security chip	Trusted Platform Module , Atmel chip, TCG 1.2-compliant														
Fingerprint reader	<i>Some:</i> Fingerprint reader on palm rest , swipe sensor, supports the security chip														
Limited warranty ¹²	3-years/1-yr battery - EasyServ™.19 depot repair service / service upgrades²² available														
1GB PC2-5300 DDR2 SODIMM	40Y7734				T/R 14W Standard Battery 4-cell				41U3196						
2GB PC2-5300 DDR2 SODIMM	40Y7735				T/R 14W Enhanced Battery 6-cell				41U3198						
ThinkPad DVD Ultrabay Slim Burner (flat)	41N5643				T/R 14W High Capacity Batt 9-cell				43R2499						
128GB SSD SATA 3.0Gb/s 1.8" (2.5" cover)	43N3406				Advanced Ultrabay Battery II 3-cell				43R9250						
200GB Disk FDE SATA 1.5Gb/s (7200 rpm)	41N5738				ThinkPad External Battery Charger				40Y7625						
USB 2.0 Security Memory Key 4GB	41U5120				ThinkPad 90W AC Adapter				40Y7659						
USB 2.0 Super Multi-Burner Drive	41N5565				90W Slim AC/DC Combo Adapter				41N8460						
ThinkPad Convertible Monitor Stand	40Y7620				ThinkPad Business Backpack				43R2482						
ThinkPad Essential Port Replicator	250510W				ThinkVision® L1940p Wide 19" Monitor				4424HB6						
ThinkPad Advanced Mini Dock	250410U				ThinkVision L2240p Wide 22" Monitor				4422HB6						
ThinkPad Advanced Dock	250310U				ThinkVision L2440x Wide 24" Monitor				4421HB2						
Other accessories on O-T61 sheet	Other accessories at lenovo.com/accessories														
												Supports ThinkVantage® technologies			
												65-watt (GMA graphics) AC adapter ThinkPad Roll Cage and Top Cover Roll Cage (one-piece magnesium) ENERGY STAR® 4.0-compliant RoHS-compliant International Warranty Service ¹⁷ 24 hour x 7 day ¹⁸ toll-free support during the warranty period ¹² via 800-426-7378			
												ThinkPlus™.22 2-year LOR ²⁴ 9x5 NBD 41C9175			
												ThinkPlus 3-year LOR 9x5 NBD 41C9176			
												ThinkPlus 4-year LOR 9x5 NBD 41C9177			
												ThinkPlus 5-year LOR 9x5 NBD 41C9179			
												ThinkPlus 4-year P&L P/U Depot 41C9178			
												ThinkPlus 5-year P&L P/U Depot 41C9180			
												Post-warranty annual maintenance agreements at lenovo.com/thinkplus/warranty			

See footnotes for important warranty information

US models announced April 10, 2008; previous models on February 19, 2008

© Lenovo
(ML2-1) April 2008

ThinkPad® T61u 14W 7659 (GMA) - Education (Linux)

Personal Systems Reference (PSREF)

Proc- Type-model	essor GHz	Memory	Wide- screen display	Graphics controller	Disk SATA GB ³ rpm	EIDE optical	Mini PCIe 802.11 wireless	Mini PCIe WWAN or Turbo	Card slot	Blue- tooth	Finger Bat- print tery reader cells	Workhorse (W) Linux Global (G) preload Entry (E)	Avail date
7659-3AU	T8300	2.40	1GB	14.1" WXGA	GMA	80G 5400	Combo	*Intel 11a/b/g ³²	None	/54	None	6 SLED10	No Feb 08
Positioning Processor	<i>Premiere performance; two spindles</i> Intel® Core™ 2 Duo processor T8300 with dual-core, Intel 64 Technology, Enhanced Intel SpeedStep technology ¹ , Intel Dynamic Acceleration, Execute Disable Bit, Virtualization Technology, 800MHz system bus, and 3MB shared L2 cache												
Memory	1GB std / 4GB max ⁷ / PC2-5300 667MHz DDR2, non-parity, dual-channel capable, two 200-pin SO-DIMM sockets; <i>Non-italics:</i> standard memory in 1 socket; 1 socket available												
Diskette drive	None (use optional USB-based diskette drive)												
EIDE Combo	DVD-ROM/CD-RW, 24X/24X/24X/8X ²¹ speed, removable from Ultrabay Slim												
Ultrabay Slim	One modular bay for interchangeable devices (right side), 9.5mm high bay, flat bezel												
Serial ATA disk	80GB⁸ (5400 rpm) / SATA 1.5Gb/s, 9.5mm high, removable, upgradable, 9.5mm high bay, supports 2nd disk, ThinkPad Shock Mounted Hard Drive												
Widescreen display	14.1" (358.1mm) WXGA (1280x800) color , anti-glare, 185 nits, 16:10 aspect ratio, 300:1 contrast ratio												
Camera	None												
Graphics	Intel Graphics Media Accelerator X3100 (GMA X3100) , integrated in GM965												
Keyboard	89-key, ThinkVantage button, spill-resistant, multimedia Fn keys, Windows/Appl keys												
TrackPoint®	TrackPoint® pointing device, "Press-to-Select," Internet Scroll Bar ¹³ , magnifying glass												
Touch pad	UltraNav™ multi-pointing system, touch pad below keyboard, Tap Zones												
ThinkLight™	Illuminates the keyboard to improve visibility in low-light conditions												
Dimensions ³	<i>6-cell 14.1W™ (WxDxH):</i> 13.2" x 10.2" x 1.09–1.26"; 335 x 261mm x 27.6–31.9mm												
Weight ²	<i>6-cell:</i> starting at 5.3 lb (2.4kg)												
Case material	<i>Top:</i> Super-Elastic PolyCarbonate (SEPC); <i>Bottom:</i> Carbon-Fiber Reinforced Plastic												
Battery - type	Lithium Ion 6-cell , supports unique 2nd battery in Ultrabay Slim												
Battery - life ¹⁰	Not published												
Chipset	Mobile Intel GM965 Express Chipset (Graphics Memory Controller Hub); ICH8M-Enhanced I/O Controller Hub (SATA 3.0Gb/s, ATA-100 EIDE, PCI Express [®] x1, PCI bus, USB, LPC bus, [Bluetooth], [fingerprint]) / PCI bus (Ricoh® R5C847 Cardbus/1394/Multicard) / LPC bus (WPCN385 Super I/O, Atmel® 97SC3203 TPM)												
PC Card	One slot (Type I, Type II), CardBus 32-bit												
ExpressCard/54	One slot (ExpressCard/34, ExpressCard/54)												
Smart Card Read	None												
Multicard Reader	None												
Ports	Three USB 2.0, DB-15 (external VGA monitor), RJ-11 (modem), RJ-45 (ethernet), IEEE 1394 FireWire 400 (4-pin connector; 1394a-2000 standard)												
Wireless antenna	UltraConnect™ II antenna / on-off switch for all wireless radios												
Mini PCI Express	Two Mini PCI Express slots / only 802.11 wireless is customer upgradable												
Intel 11a/b/g ³²	11a/b/g wireless ⁴ , Mini PCIe adapter, Intel PRO/Wireless 3945ABG												
WWAN	None												
Turbo Memory	None												
Modem	56K V.92 ⁶ modem in Communications Daughter Card socket												
Bluetooth™	None												
Ethernet	Gigabit ethernet, Intel 82566MM Nineveh (PHY), PCIe x1 (GLCI), PXE												
Intel AMT	Not supported												
Audio support	High Definition (HD) Audio, AD1984HD codec / stereo speakers, 1 watt / volume up, down, mute buttons / internal microphone, microphone input jack, headphone jack												
Security	Power-on password, hard disk password, supervisor password, security keyhole												
Security chip	Trusted Platform Module , Atmel chip, TCG 1.2-compliant												
Fingerprint reader	None												
Limited warranty ¹²	3-years/1-yr battery - EasyServ™ ¹⁹ depot repair service / service upgrades ²² available												
1GB PC2-5300 DDR2 SODIMM	40Y7734			T/R 14W Standard Battery 4-cell				41U3196					
2GB PC2-5300 DDR2 SODIMM	40Y7735			T/R 14W Enhanced Battery 6-cell				41U3198					
ThinkPad DVD Ultrabay Slim Burner (flat)	41N5643			T/R 14W High Capacity Batt 9-cell				43R2499					
Serial Hard Drive Ultrabay Slim Adapter (flat)	40Y8725			Advanced Ultrabay Battery II 3-cell				43R9250					
128GB SSD SATA 3.0Gb/s 1.8" (2.5" cover)	43N3406			ThinkPad External Battery Charger				40Y7625					
320GB Disk SATA 1.5Gb/s (5400 rpm)	43N3403			90W Slim AC/DC Combo Adapter				41N8460					
USB 2.0 Ultra Secure Memory Key 8GB	45J5918			ThinkPad Business Topload Case				43R2476					
USB 2.0 Lenovo Enhanced Port Replicator	43R8770			ThinkPad Business Backpack				43R2482					
ThinkPad Essential Port Replicator	250510W			ThinkVision™ L1940p Wide 19" Monitor				4424HB6					
ThinkPad Advanced Mini Dock	250410U			ThinkVision L2240p Wide 22" Monitor				4422HB6					
ThinkPad Advanced Dock	250310U			ThinkVision L2440x Wide 24" Monitor				4421HB2					
Check Linux compatibility for other accessories	Other accessories at lenovo.com/accessories												
Preloaded operating system ²⁰	- SUSE® Linux™ Enterprise Desktop10 Service Pack 1												
Preloaded applications ¹⁴	• None												
Supported devices (only some listed)	<ul style="list-style-type: none"> • HD Audio • Intel 3945ABG wireless • Intel Graphics Media Accelerator X3100 (GMA X3100) • NVIDIA Quadro NVS 140M • Fingerprint reader • Bluetooth • Function keys • ThinkPad Advanced Dock 												
Non-supported devices (only some listed)	<ul style="list-style-type: none"> • Intel 4965AG, Intel 4965AGN, ThinkPad 11a/b/g, ThinkPad 11n wireless • WWAN • Active Protection System™ • ThinkVantage® button • Security chip • Intel Turbo Memory • Intel AMT technology • Integrated camera 												
Non-supported applications (only some listed)	<ul style="list-style-type: none"> • ThinkPad Utilities • ThinkVantage technologies • Presentation Director • Encrypted DVD playback • Keyboard Customizer 												
65-watt (GMA graphics) AC adapter	ThinkPad Roll Cage and Top Cover												
Roll Cage (one-piece magnesium)	RoHS-compliant												
International Warranty Service ¹⁷	24 hour x 7 day ¹⁸ toll-free support during the warranty period ¹² via 800-426-7378												
ThinkPlus™. ²² 2-year LOR ²⁴ 9x5 NBD	41C9175												
ThinkPlus 3-year LOR 9x5 NBD	41C9176												
ThinkPlus 4-year LOR 9x5 NBD	41C9177												
ThinkPlus 5-year LOR 9x5 NBD	41C9179												
ThinkPlus 4-year P&L P/U Depot	41C9178												
ThinkPlus 5-year P&L P/U Depot	41C9180												
Post-warranty annual maintenance agreements at	lenovo.com/thinkplus/warranty												

See footnotes for important warranty information
 US model announced February 19, 2008

* Intel Centrino® processor technology

© Lenovo
 (ML2-3) February 2008

ThinkPad® T61u 14W 7663 (NVIDIA®) - Education (EasyServ)

Personal Systems Reference (PSREF)

Proc- Type-model essor	GHz	Memory	Wide- screen display	Graphics controller memory	Cam- era	Disk SATA GB ⁸ rpm	EIDE optical	Mini PCIe 802.11 wireless	Mini PCIe WWAN or Turbo	Card slot	Blue- tooth	Vista preload	Workhorse (W) Limited Gbl (G) warranty ¹²	Avail date	
7663-N1U	T9300	2.50	1GB	14.1" WXGA+	128MB	Cam 100G 7200	DVD±RW	11a/b/g	None	4-in-1	Blue	Business32	EasyServ	No	Feb 08
7663-05U	T9300	2.50	2GB	14.1" WXGA+	128MB	Cam 160G 7200	DVD±RW	11a/b/g	None	4-in-1	Blue	Business32	EasyServ	No	Apr 08

Italic MTM: not a base model for building a custom model

• **These models have an EasyServ™¹⁹ depot repair service 3-year limited warranty**

Educational models are available only to public or private K-12 or higher accredited schools organized and operated exclusively for educational purposes for use by qualified students and teachers.

Processor	Intel® Core™ 2 Duo processor T9300 with dual-core, Intel 64 Technology, Enhanced Intel SpeedStep technology ¹ , Intel Dynamic Acceleration, Execute Disable Bit, Virtualization Technology, 800MHz system bus, and 6MB shared L2 cache										Preloaded operating system²⁰ - Microsoft® Windows® Vista® Business Edition (32-bit) ◇ Vista Premium logo			
Memory	1GB or 2GB std / 4GB max ⁷ / PC2-5300 667MHz DDR2, non-parity, dual-channel capable, two 200-pin SO-DIMM sockets; <i>Non-italics:</i> standard memory in one socket; one socket available										Preloaded applications¹⁴ • Microsoft Office OneNote® 2007 (and CD) • Education software - VitalSource Library College Edition - Adobe® Instructor Resource Cntr - Adobe Digital School Collection - Photoshop Elements (and CD) - Premier Elements (and DVD) - Acrobat 8 Professional - Contribute 4 • Rescue and Recovery™ • Access Connections™ • Client Security Solution™ • ThinkVantage Productivity Center • ThinkVantage System Update • System Migration Assistant • Norton Internet Security™ (90 days of virus definitions) • DiskKeeper® Home • PC-Doctor™ (diagnostics) • ThinkPad Utilities (Power Manager and Presentation Director) • Adobe® Reader • Windows Live™ Toolbar • Windows Live Search • Picasa from Google • Some: Fingerprint Software • Microsoft Office 2007 Trial (60-day) • Sonic RecordNow and Drive Letter Access (DVD±RW) • Corel® WinDVD® (DVD±RW)			
Diskette drive	None (use optional USB-based diskette drive)													
EIDE DVD±RW	DVD burner, Super Multi-Burner (40Y8623) dual-layer, removable Ultrabay Slim													
Ultrabay Slim	One modular bay for interchangeable devices (right side), 9.5mm high bay, flat bezel													
Serial ATA disk	100GB⁸ (7200 rpm) or 160GB⁸ (7200 rpm) / SATA 1.5Gb/s, 9.5mm high, removable, upgradable, 9.5mm high bay, supports 2nd disk, ThinkPad Shock Mounted Hard Drive, Active Protection System™													
Widescreen display	14.1" (358.1mm) WXGA+ (1440x900) color , anti-glare, 200 nits, 16:10 aspect ratio, 300:1 contrast ratio													
Camera	Camera on top of screen, 1.3-megapixel, fixed focus, USB 2.0													
Graphics	NVIDIA® Quadro® NVS 140M , PCI Express® x16, 128MB memory, TurboCache, DVI pass-through support to optional Advanced Mini Dock or Advanced Dock													
Keyboard	89-key, ThinkVantage button, spill-resistant, multimedia Fn keys, Windows/Appl keys													
TrackPoint®	TrackPoint® pointing device, "Press-to-Select," Internet Scroll Bar ¹³ , magnifying glass													
Touch pad	UltraNav™ multi-pointing system, touch pad below keyboard, Tap Zones													
ThinkLight™	Illuminates the keyboard to improve visibility in low-light conditions													
Dimensions ³	6-cell 14.1W" (WxDxH): 13.2" x 10.2" x 1.09–1.26"; 335 x 261mm x 27.6–31.9mm													
Weight ²	6-cell: starting at 5.3 lb (2.4kg)													
Case material	<i>Top:</i> Super-Elastic PolyCarbonate (SEPC); <i>Bottom:</i> Carbon-Fiber Reinforced Plastic													
Battery - type	Lithium Ion 6-cell , supports unique 2nd battery in Ultrabay Slim													
Battery - life ¹⁰	6-cell: up to 3.8 hr; 6-cell plus Ultrabay battery: up to 5.3 hr													
Chipset	Mobile Intel PM965 Express Chipset (Memory Controller Hub); ICH8M-Enhanced I/O Controller Hub (SATA 3.0Gb/s, ATA-100 EIDE, PCI Express x1, PCI bus, USB, LPC bus, [Bluetooth], [fingerprint]) / PCI bus (Richo® R5C847 Cardbus/1394/Multicard) / LPC bus (WPCN385 Super I/O, Atmel® 97SC3203 TPM)													
PC Card	One slot (Type I, Type II), CardBus 32-bit													
ExpressCard slot	None													
Smart Card Read	None													
Multicard Reader	4-in-1 reader (MultiMediaCard, Memory Stick PRO, Secure Digital, xD-Picture Card™)													
Ports	Three USB 2.0, DB-15 (external VGA monitor), RJ-11 (modem), RJ-45 (ethernet), IEEE 1394 FireWire 400 (4-pin connector; 1394a-2000 standard)													
Wireless antenna	UltraConnect™ II antenna / on-off switch for all wireless radios													
Mini PCI Express	Two Mini PCI Express slots / only 802.11 wireless is customer upgradable													
11a/b/g ³²	11a/b/g wireless ⁴ , ThinkPad 11a/b/g Mini PCIe Adapter, Atheros AR5006EX													
WWAN	None													
Turbo Memory	None													
Modem	56K V.92 ⁶ modem in Communications Daughter Card socket													
Bluetooth™	Bluetooth 2.0 wireless, USB 2.0 interface via ICH8M, LED indicator										Supports ThinkVantage® technologies			
Ethernet	Gigabit ethernet, Intel 82566MM Nineveh (PHY), PCIe x1 (GLCI), PXE													
Intel AMT	Intel Active Management Technology (iAMT)													
Audio support	High Definition (HD) Audio, AD1984HD codec / stereo speakers, 1 watt / volume up, down, mute buttons / internal microphone, microphone input jack, headphone jack													
Security	Power-on password, hard disk password, supervisor password, security keyhole													
Security chip	Trusted Platform Module , Atmel chip, TCG 1.2-compliant													
Fingerprint reader	Fingerprint reader on palm rest , swipe sensor, supports the security chip													
Limited warranty ¹²	3-years/1-yr battery - EasyServ™¹⁹ depot repair service / service upgrades²² available													
1GB PC2-5300 DDR2 SODIMM	40Y7734			T/R 14W Standard Battery 4-cell			41U3196							
2GB PC2-5300 DDR2 SODIMM	40Y7735			T/R 14W Enhanced Battery 6-cell			41U3198							
ThinkPad DVD Ultrabay Slim Burner (flat)	41N5643			T/R 14W High Capacity Batt 9-cell			43R2499			ThinkPlus™. ²² 2-year LOR ²⁴ 9x5 NBD 41C9175				
Serial Hard Drive Ultrabay Slim Adapter (flat)	40Y8725			Advanced Ultrabay Battery II 3-cell			43R9250			ThinkPlus 3-year LOR 9x5 NBD 41C9176				
128GB SSD SATA 3.0Gb/s 1.8" (2.5" cover)	43N3406			ThinkPad External Battery Charger			40Y7625			ThinkPlus 4-year LOR 9x5 NBD 41C9177				
200GB Disk FDE SATA 1.5Gb/s (7200 rpm)	41N5738			ThinkPad 90W AC Adapter			40Y7659			ThinkPlus 5-year LOR 9x5 NBD 41C9179				
USB 2.0 Security Memory Key 4GB	41U5120			90W Slim AC/DC Combo Adapter			41N8460			ThinkPlus 4-year P&L P/U Depot 41C9178				
USB 2.0 Ultra Secure Memory Key 8GB	45J5918			ThinkPad Business Topload Case			43R2476			ThinkPlus 5-year P&L P/U Depot 41C9180				
USB 2.0 Super Multi-Burner Drive	41N5565			ThinkPad Business Backpack			43R2482			Post-warranty annual maintenance agreements at lenovo.com/thinkplus/warranty				
USB 2.0 Lenovo Enhanced Port Replicator	43R8770			ThinkPad Deluxe Expander Case			43R2478							
ThinkPad Adjustable Notebook Stand	40Y7676			ThinkVision® L1700p 17" Monitor			9417HE2							
ThinkPad Convertible Monitor Stand	40Y7620			ThinkVision L1940p Wide 19" Monitor			4424HB6							
ThinkPad Essential Port Replicator	250510W			ThinkVision L2240p Wide 22" Monitor			4422HB6							
ThinkPad Advanced Mini Dock	250410U			ThinkVision L2440p Wide 24" Monitor			4420HB2							
ThinkPad Advanced Dock	250310U			ThinkVision L2440x Wide 24" Monitor			4421HB2							
Other accessories on O-T61 sheet	Other accessories at lenovo.com/accessories													

See footnotes for important warranty information

Ⓜ US model announced April 10, 2008; previous model on February 19, 2008

© Lenovo
(ML2-2) April 2008

ThinkPad® T61u 14W 7663 (NVIDIA®) - Education (Linux)

Personal Systems Reference (PSREF)

Type-model	Proc- essor	GHz	Memory	Wide- screen display	Graphics controller memory	Disk SATA GB ⁵ rpm	EIDE optical	Mini PCIe 802.11 wireless	Mini PCIe WWAN or Turbo	Card slot	Blue- tooth	Bat- tery cells	Linux preload	Workhorse (W) Global (G) Entry (E)	Avail date
7663-3MU	T8300	2.40	1GB	14.1" WXGA+	128MB	120G 5400	DVD±RW	* Intel 11a/b/g ³²	None	/54	Blue	6-cell	SLED10	No	Feb 08
Positioning Processor	<i>Premiere performance; two spindles</i> Intel® Core™ 2 Duo processor T8300 with dual-core, Intel 64 Technology, Enhanced Intel SpeedStep technology ¹ , Intel Dynamic Acceleration, Execute Disable Bit, Virtualization Technology, 800MHz system bus, and 3MB shared L2 cache											Preloaded operating system²⁰ - SUSE® Linux™ Enterprise Desktop10 Service Pack 1 Preloaded applications¹⁴ • None			
Memory	1GB std / 4GB max ⁷ / PC2-5300 667MHz DDR2, non-parity, dual-channel capable, two 200-pin SO-DIMM sockets; <i>Non-italics:</i> standard memory in 1 socket; 1 socket available											Supported devices (only some listed) • HD Audio • Intel 3945ABG wireless • Intel Graphics Media Accelerator X3100 (GMA X3100) • NVIDIA Quadro NVS 140M • Fingerprint reader • Bluetooth • Function keys • ThinkPad Advanced Dock			
Diskette drive	None (use optional USB-based diskette drive)											Non-supported devices (only some listed) • Intel 4965AG, Intel 4965AGN, ThinkPad 11a/b/g, ThinkPad 11n wireless • WWAN • Active Protection System™ • ThinkVantage® button • Security chip • Intel Turbo Memory • Intel AMT technology • Integrated camera			
EIDE DVD±RW	DVD burner, Super Multi-Burner (40Y8623) dual-layer, removable Ultrabay Slim														
Ultrabay Slim	One modular bay for interchangeable devices (right side), 9.5mm high bay, flat bezel											Non-supported applications (only some listed) • ThinkPad Utilities • ThinkVantage technologies • Presentation Director • Encrypted DVD playback • Keyboard Customizer			
Serial ATA disk	120GB⁸ (5400 rpm) / SATA 1.5Gb/s, 9.5mm high, removable, upgradable, 9.5mm high bay, supports 2nd disk, ThinkPad Shock Mounted Hard Drive														
Widescreen display	14.1" (358.1mm) WXGA+ (1440x900) color , anti-glare, 200 nits, 16:10, 300:1, 300:1 contrast ratio											90-watt (NVIDIA) AC adapter ThinkPad Roll Cage and Top Cover Roll Cage (one-piece magnesium) RoHS-compliant International Warranty Service¹⁷ 24 hour x 7 day¹⁸ toll-free support during the warranty period¹² via 800-426-7378			
Camera	None														
Graphics	NVIDIA® Quadro® NVS 140M , PCI Express® x16, 128MB memory, TurboCache, DVI pass-through support to optional Advanced Mini Dock or Advanced Dock														
Keyboard	89-key, ThinkVantage button, spill-resistant, multimedia Fn keys, Windows/Apply keys														
TrackPoint®	TrackPoint® pointing device, "Press-to-Select," Internet Scroll Bar ¹³ , magnifying glass														
Touch pad	UltraNav™ multi-pointing system, touch pad below keyboard, Tap Zones														
ThinkLight™	Illuminates the keyboard to improve visibility in low-light conditions														
Dimensions ³	<i>6-cell 14.1W™ (WxDxH):</i> 13.2" x 10.2" x 1.09–1.26"; 335 x 261mm x 27.6–31.9mm														
Weight ²	<i>6-cell:</i> starting at 5.3 lb (2.4kg)														
Case material	<i>Top:</i> Super-Elastic PolyCarbonate (SEPC); <i>Bottom:</i> Carbon-Fiber Reinforced Plastic														
Battery - type	Lithium Ion 6-cell , supports unique 2nd battery in Ultrabay Slim														
Battery - life ¹⁰	Not published														
Chipset	Mobile Intel PM965 Express Chipset (Memory Controller Hub); ICH8M-Enhanced I/O Controller Hub (SATA 3.0Gb/s, ATA-100 EIDE, PCI Express x1, PCI bus, USB, LPC bus, [Bluetooth], [fingerprint]) / PCI bus (Ricoh® R5C847 Cardbus/1394/Multicard) / LPC bus (WPCN385 Super I/O, Atmel® 97SC3203 TPM)											Non-supported applications (only some listed) • ThinkPad Utilities • ThinkVantage technologies • Presentation Director • Encrypted DVD playback • Keyboard Customizer			
PC Card	One slot (Type I, Type II), CardBus 32-bit														
ExpressCard/54	One slot (ExpressCard/34, ExpressCard/54)														
Smart Card Read	None														
Multicard Reader	None														
Ports	Three USB 2.0, DB-15 (external VGA monitor), RJ-11 (modem), RJ-45 (ethernet), IEEE 1394 FireWire 400 (4-pin connector; 1394a-2000 standard)														
Wireless antenna	UltraConnect™ II antenna / on-off switch for all wireless radios														
Mini PCI Express	Two Mini PCI Express slots / only 802.11 wireless is customer upgradable														
Intel 11a/b/g ³²	11a/b/g wireless ⁴ , Mini PCIe adapter, Intel PRO/Wireless 3945ABG														
WWAN	None														
Turbo Memory	None														
Modem	56K V.92 ⁶ modem in Communications Daughter Card socket														
Bluetooth™	Bluetooth 2.0 wireless, USB 2.0 interface via ICH8M, LED indicator														
Ethernet	Gigabit ethernet, Intel 82566MM Nineveh (PHY), PCIe x1 (GLCI), PXE														
Intel AMT	Not supported														
Audio support	High Definition (HD) Audio, AD1984HD codec / stereo speakers, 1 watt / volume up, down, mute buttons / internal microphone, microphone input jack, headphone jack														
Security	Power-on password, hard disk password, supervisor password, security keyhole														
Security chip	Trusted Platform Module , Atmel chip, TCG 1.2-compliant														
Fingerprint reader	Fingerprint reader on palm rest , swipe sensor, supports the security chip														
Limited warranty ¹² 3-years/1-yr battery - EasyServ™ ¹⁹ depot repair service / service upgrades ²² available															
1GB PC2-5300 DDR2 SODIMM	40Y7734	T/R 14W Standard Battery 4-cell				41U3196									
2GB PC2-5300 DDR2 SODIMM	40Y7735	T/R 14W Enhanced Battery 6-cell				41U3198									
ThinkPad DVD Ultrabay Slim Burner (flat)	41N5643	T/R 14W High Capacity Batt 9-cell				43R2499									
Serial Hard Drive Ultrabay Slim Adapter (flat)	40Y8725	Advanced Ultrabay Battery II 3-cell				43R9250									
128GB SSD SATA 3.0Gb/s 1.8" (2.5" cover)	43N3406	ThinkPad External Battery Charger				40Y7625									
320GB Disk SATA 1.5Gb/s (5400 rpm)	43N3403	90W Slim AC/DC Combo Adapter				41N8460									
USB 2.0 Security Memory Key 4GB	41U5120	ThinkPad Business Topload Case				43R2476									
ThinkPad Essential Port Replicator	250510W	ThinkPad Business Backpack				43R2482									
ThinkPad Advanced Mini Dock	250410U	ThinkVision® L2240p Wide 22" Monitor				4422HB6									
ThinkPad Advanced Dock	250310U	ThinkVision L2440p Wide 24" Monitor				4420HB2									
Check Linux compatibility for other accessories															
Other accessories at lenovo.com/accessories															
ThinkPlus™. ²² 2-year LOR ²⁴ 9x5 NBD 41C9175															
ThinkPlus 3-year LOR 9x5 NBD 41C9176															
ThinkPlus 4-year LOR 9x5 NBD 41C9177															
ThinkPlus 5-year LOR 9x5 NBD 41C9179															
ThinkPlus 4-year P&L P/U Depot 41C9178															
ThinkPlus 5-year P&L P/U Depot 41C9180															

See footnotes for important warranty information
 US model announced February 19, 2008

* Intel Centrino® processor technology

© Lenovo
 (ML2-4) February 2008

ThinkPad® T61 15W (GMA Graphics)

Type-model	Proc- essor	GHz	Memory	Wide- screen display	Graphics controller	Disk SATA GB ³ rpm	EIDE optical	Mini PCIe 802.11 wireless	Mini PCIe WWAN or Turbo	Card slot	Blue- tooth	Bat- tery Vista preload	Workhorse (W) Global (G) Entry (E)	Avail date
6463-4YU	T7300	2.00	1GB	15.4" WXGA	GMA	80GB 5400	Combo	* Intel 4965AG ³²	None	Smart	Blue	6	Business32 W G	Jun 07
6463-4XU	T7300	2.00	1GB	15.4" WXGA	GMA	120G 5400	Combo	* Intel 4965AG	None	Smart	Blue	6	Business32 W G	Jun 07
✕ 6463-5BU	T7300	2.00	1GB	15.4" WXGA	GMA	80GB 5400	Combo	* Intel 4965AG	None	Smart	Blue	6	XP Pro W G	Jun 07
Positioning Processor	<i>Premiere performance; two spindles</i> Intel® Core™ 2 Duo processor T7300 with dual-core , Intel 64 Technology, Enhanced Intel SpeedStep® technology ¹ , Intel Dynamic Acceleration, Execute Disable Bit, Virtualization Technology, 800MHz system bus, and 4MB shared L2 cache											Preloaded operating system²⁰ - <i>Some:</i> Microsoft® Windows® XP Professional - <i>Some:</i> Microsoft Windows Vista™ Business Edition (32-bit) ◇ 6463-4YU/4XU: Vista Basic logo		
Memory	1GB std / 4GB max ⁷ / PC2-5300 667MHz DDR2, non-parity, dual-channel capable, two 200-pin SO-DIMM sockets; <i>Non-italics:</i> standard memory in 1 socket; 1 socket available											Preloaded applications¹⁴ (all OSes) • Rescue and Recovery™ • Access Connections™ • Client Security Solution™ • ThinkVantage Productivity Center • ThinkVantage System Update • System Migration Assistant • Norton Internet Security™ (90 days of virus definitions) • Diskeeper® Home • PC-Doctor™ (diagnostics) • ThinkPad Utilities (Power Manager and Presentation Director) • Adobe® Reader • Windows Live™ Toolbar • Windows Live Search • Picasa from Google • Fingerprint Software • Microsoft Office 2007 Trial (60-day)		
Diskette drive	None (use optional USB-based diskette drive)													
EIDE Combo	DVD-ROM/CD-RW, 24X/24X/24X/8X ²¹ speed, removable from Ultrabay Slim													
Ultrabay Slim	One modular bay for interchangeable devices (right side), 9.5mm high bay, flat bezel													
Serial ATA disk	80GB⁸ (5400 rpm) or 120GB⁸ (5400 rpm) / SATA 1.5Gb/s, 9.5mm high, removable, upgradable, 9.5mm high bay, supports 2nd disk, ThinkPad Shock Mounted Hard Drive, Active Protection System™													
Widescreen display	15.4" (391mm) WXGA (1280x800) color , anti-glare, 200 nits, 16:10 aspect ratio, 300:1 contrast ratio													
Camera	None													
Graphics	Intel Graphics Media Accelerator X3100 (GMA X3100) , integrated in GM965, DVI pass-through support to optional Advanced Mini Dock or Advanced Dock													
Keyboard	89-key, ThinkVantage button, spill-resistant, multimedia Fn keys, Windows/Appl keys													
TrackPoint®	TrackPoint® pointing device, "Press-to-Select," Internet Scroll Bar ¹³ , magnifying glass													
Touch pad	UltraNav™ multi-pointing system, touch pad below keyboard, Tap Zones													
ThinkLight™	Illuminates the keyboard to improve visibility in low-light conditions													
Dimensions ³	<i>15.4" models (WxDxH):</i> 14.1" x 10.0" x 1.2–1.4"; 358.4mm x 255mm x 29.8–34.5mm													
Weight ²	with optical drive and battery: starting at 5.9 lb (2.7kg)													
Case material	<i>Top:</i> Super-Elastic PolyCarbonate (SEPC); <i>Bottom:</i> Carbon-Fiber Reinforced Plastic													
Battery - type	Lithium Ion 6-cell / supports unique 2nd battery in Ultrabay Slim													
Battery - life ¹⁰	<i>6-cell:</i> up to 5.5 hr; <i>9-cell:</i> up to 8.3 hr; <i>9-cell plus Ultrabay battery:</i> up to 9.8 hr													
Chipset	Mobile Intel GM965 Express Chipset (Graphics Memory Controller Hub); ICH8M-Enhanced I/O Controller Hub (SATA 3.0Gb/s, ATA-100 EIDE, PCI Express® x1, PCI bus, USB, LPC bus, [Bluetooth], [fingerprint]) / PCI bus (Ricoh® R5C847 Cardbus/1394/Multicard) / LPC bus (WPCN385 Super I/O, Atmel® 97SC3203 TPM)													
PC Card	One slot (Type I, Type II), CardBus 32-bit													
ExpressCard slot	None													
Smart Card Reader	Smart Card Reader													
Multicard Reader	4-in-1 reader (MultiMediaCard, Memory Stick® PRO™, Secure Digital, xD-Picture Card™)													
Ports	Three USB 2.0, DB-15 (external VGA monitor), RJ-11 (modem), RJ-45 (ethernet), IEEE 1394 FireWire 400 (4-pin connector; 1394a-2000 standard)													
Wireless antenna	UltraConnect™ II antenna / on-off switch for all wireless radios											Supports ThinkVantage® technologies		
Mini PCI Express	Three Mini PCI Express slots / only 802.11 wireless is customer upgradable													
Intel 4965AG ³²	11a/b/g wireless ⁴ , Mini PCIe adapter, Intel Wireless WiFi Link 4965AG													
WWAN	None													
Turbo Memory	None													
UWB	None (uses Half-Mini PCI Express slot)													
Modem	56K V.92 ⁶ modem in Communications Daughter Card socket													
Bluetooth™	Bluetooth 2.0 wireless, USB 2.0 interface via ICH8M, LED indicator													
Ethernet	Gigabit ethernet, Intel 82566MM Nineveh (PHY), PCIe x1 (GLCI), PXE													
Intel AMT	Intel Active Management Technology (IAMT)													
Audio support	High Definition (HD) Audio, AD1984JCP codec / stereo speakers, 1 watt / volume up, down, mute buttons / internal microphone, microphone input jack, headphone jack													
Security	Power-on password, hard disk password, supervisor password, security keyhole													
Security chip	Trusted Platform Module , Atmel chip, TCG 1.2-compliant													
Fingerprint reader	Fingerprint reader on palm rest , swipe sensor, supports the security chip													
Limited warranty ¹²	3-years/1-yr battery - EasyServ™.19 depot repair service / service upgrades ²² available													
1GB PC2-5300 DDR2 SODIMM	40Y7734			T/R/W/SL Series Li-Ion Battery 6-cell			40Y6799			ThinkPlus™.22 2-year LOR ²⁴ 9x5 NBD				
2GB PC2-5300 DDR2 SODIMM	40Y7735			T/R/W/SL Series Li-Ion Battery 9-cell			40Y6797			41C9175				
ThinkPad DVD Ultrabay Slim Burner (flat)	41N5643			Advanced Ultrabay Battery II 3-cell			43R9250			ThinkPlus 3-year LOR 9x5 NBD				
Serial Hard Drive Ultrabay Slim Adapter (flat)	40Y8725			ThinkPad External Battery Charger			40Y7625			41C9176				
128GB SSD SATA 3.0Gb/s 1.8" (2.5" cover)	43N3406			ThinkPad 90W AC Adapter			40Y7659			ThinkPlus 4-year LOR 9x5 NBD				
200GB Disk FDE SATA 1.5Gb/s (7200 rpm)	41N5738			90W Slim AC/DC Combo Adapter			41N8460			41C9177				
320GB Disk SATA 1.5Gb/s (5400 rpm)	43N3403			ThinkPad Business Topload Case			43R2476			ThinkPlus 5-year LOR 9x5 NBD				
USB 2.0 Ultra Secure Memory Key 8GB	45J5918			ThinkPad Business Backpack			43R2482			41C9179				
USB 2.0 Super Multi-Burner Drive	41N5565			ThinkPad Deluxe Expander Case			43R2478			ThinkPlus 4-year P&L P/U Depot				
USB 2.0 Lenovo Enhanced Port Replicator	43R8770			ThinkPad Executive Leather Case			43R2480			41C9178				
ThinkPad Convertible Monitor Stand	40Y7620			ThinkVision® L1700p 17" Monitor			9417HE2			ThinkPlus 5-year P&L P/U Depot				
ThinkPad Essential Port Replicator	250510W			ThinkVision L1940p Wide 19" Monitor			4424HB6			41C9180				
ThinkPad Advanced Mini Dock	250410U			ThinkVision L2240p Wide 22" Monitor			4422HB6			Post-warranty annual maintenance agreements at				
ThinkPad Advanced Dock	250310U			ThinkVision L2440x Wide 24" Monitor			4421HB2			lenovo.com/thinkplus/warranty				
Other accessories on O-T61 sheet														

See footnotes for important warranty information
US models announced May 31, 2007

✕ US model withdrawn effective May 28

* Intel Centrino® with vPro™ technology

ThinkPad® T61 15W 6464 (GMA) - Onsite

Personal Systems Reference (PSREF)

Proc- Type-model	essor GHz	Memory	Wide- screen display	Graphics controller	Disk SATA GB ³ rpm	EIDE optical	Mini PCIe 802.11 wireless	Mini PCIe WWAN or Turbo	Card slot	Blue- tooth	Bat- tery cells	Workhorse (W) Vista Global (G) Global (G) GMP (P)	Avail date
6464-4YU T7300	2.00	1GB	15.4" WXGA	GMA	80GB 5400	Combo	* Intel 4965AG ³²	None	Smart	Blue	6	Business32 W G P	Jun 07

• **This model is part of the Global Models Plus program with limited onsite service²⁴ 3-year limited warranty**

Positioning Processor	<i>Premiere performance; two spindles</i> Intel® Core™ 2 Duo processor T7300 with dual-core, Intel 64 Technology, Enhanced Intel SpeedStep® technology ¹ , Intel Dynamic Acceleration, Execute Disable Bit, Virtualization Technology, 800MHz system bus, and 4MB shared L2 cache											Preloaded operating system ²⁰ - Microsoft® Windows® Vista® Business Edition (32-bit) ◇ Vista Basic logo
Memory	1GB std / 4GB max ⁷ / PC2-5300 667MHz DDR2, non-parity, dual-channel capable, two 200-pin SO-DIMM sockets; <i>Non-italics:</i> standard memory in 1 socket; 1 socket available											Preloaded applications ¹⁴ • Rescue and Recovery™ • Access Connections™ • Client Security Solution™ • ThinkVantage Productivity Center • ThinkVantage System Update • System Migration Assistant • Norton Internet Security™ (90 days of virus definitions) • Diskeeper® Home • PC-Doctor™ (diagnostics) • ThinkPad Utilities (Power Manager and Presentation Director) • Adobe® Reader • Windows Live™ Toolbar • Windows Live Search • Picasa from Google • Fingerprint Software • Microsoft Office 2007 Trial (60-day) • Sonic RecordNow and Drive Letter Access (combo) • Corel® WinDVD® (combo)
Diskette drive EIDE Combo Ultrabay Slim Serial ATA disk	None (use optional USB-based diskette drive) DVD-ROM/CD-RW, 24X/24X/24X/8X ²¹ speed, removable from Ultrabay Slim One modular bay for interchangeable devices (right side), 9.5mm high bay, flat bezel 80GB⁸ (5400 rpm) / SATA 1.5Gb/s, 9.5mm high, removable, upgradable, 9.5mm high bay, supports 2nd disk, ThinkPad Shock Mounted Hard Drive, Active Protection System™											
Widescreen display Camera	15.4" (391mm) WXGA (1280x800) color , anti-glare, 200 nits, 16:10 aspect ratio, 300:1 contrast ratio None											
Graphics	Intel Graphics Media Accelerator X3100 (GMA X3100) , integrated in GM965, DVI pass-through support to optional Advanced Mini Dock or Advanced Dock											
Keyboard TrackPoint® Touch pad ThinkLight™	89-key, ThinkVantage button, spill-resistant, multimedia Fn keys, Windows/Appl keys TrackPoint® pointing device, "Press-to-Select," Internet Scroll Bar ¹³ , magnifying glass UltraNav™ multi-pointing system, touch pad below keyboard, Tap Zones Illuminates the keyboard to improve visibility in low-light conditions											
Dimensions ³ Weight ² Case material Battery - type Battery - life ¹⁰	<i>15.4" models (WxDxH):</i> 14.1" x 10.0" x 1.2–1.4"; 358.4mm x 255mm x 29.8–34.5mm with optical drive and battery; starting at 5.9 lb (2.7kg) <i>Top:</i> Super-Elastic PolyCarbonate (SEPC); <i>Bottom:</i> Carbon-Fiber Reinforced Plastic Lithium Ion 6-cell / supports unique 2nd battery in Ultrabay Slim <i>6-cell:</i> up to 5.5 hr; <i>9-cell:</i> up to 8.3 hr; <i>9-cell plus Ultrabay battery:</i> up to 9.8 hr											
Chipset	Mobile Intel GM965 Express Chipset (Graphics Memory Controller Hub); ICH8M-Enhanced I/O Controller Hub (SATA 3.0Gb/s, ATA-100 EIDE, PCI Express® x1, PCI bus, USB, LPC bus, [Bluetooth], [fingerprint]) / PCI bus (Ricoh® R5C847 Cardbus/1394/Multicard) / LPC bus (WPCN385 Super I/O, Atmel® 97SC3203 TPM)											
PC Card ExpressCard slot Smart Card Read Multicard Reader Ports	One slot (Type I, Type II), CardBus 32-bit None Smart Card Reader 4-in-1 reader (MultiMediaCard, Memory Stick® PRO™, Secure Digital, xD-Picture Card™) Three USB 2.0, DB-15 (external VGA monitor), RJ-11 (modem), RJ-45 (ethernet), IEEE 1394 FireWire 400 (4-pin connector; 1394a-2000 standard)											
Wireless antenna Mini PCI Express Intel 4965AG ³² WWAN Turbo Memory UWB Modem Bluetooth™ Ethernet Intel AMT Audio support	UltraConnect™ II antenna / on-off switch for all wireless radios Three Mini PCI Express slots / only 802.11 wireless is customer upgradable 11a/b/g wireless ⁴ , Mini PCIe adapter, Intel Wireless WiFi Link 4965AG None None None (uses Half-Mini PCI Express slot) 56K V.92 ⁶ modem in Communications Daughter Card socket Bluetooth 2.0 wireless, USB 2.0 interface via ICH8M, LED indicator Gigabit ethernet, Intel 82566MM Nineveh (PHY), PCIe x1 (GLCI), PXE Intel Active Management Technology (IAMT) High Definition (HD) Audio, AD1984JCP codec / stereo speakers, 1 watt / volume up, down, mute buttons / internal microphone, microphone input jack, headphone jack											
Security Security chip Fingerprint reader	Power-on password, hard disk password, supervisor password, security keyhole Trusted Platform Module , Atmel chip, TCG 1.2-compliant Fingerprint reader on palm rest , swipe sensor, supports the security chip											
Limited warranty ¹²	3-years /1-year battery, limited onsite service²⁴ , 8 am - 5 pm, Mon - Fri coverage excluding holidays, next business day response time / service upgrades ²² available											Supports ThinkVantage® technologies
1GB PC2-5300 DDR2 SODIMM 2GB PC2-5300 DDR2 SODIMM ThinkPad DVD Ultrabay Slim Burner (flat) Serial Hard Drive Ultrabay Slim Adapter (flat) 128GB SSD SATA 3.0Gb/s 1.8" (2.5" cover) 160GB Disk 9.5mm SATA 1.5Gb/s (7200 rpm) 200GB Disk FDE SATA 1.5Gb/s (7200 rpm) 320GB Disk SATA 1.5Gb/s (5400 rpm) USB 2.0 Ultra Secure Memory Key 8GB USB 2.0 Super Multi-Burner Drive ThinkPad Convertible Monitor Stand ThinkPad Essential Port Replicator ThinkPad Advanced Mini Dock ThinkPad Advanced Dock Other accessories on O-T61 sheet	40Y7734 40Y7735 41N5643 40Y8725 43N3406 41N5737 41N5738 43N3403 45J5918 41N5565 40Y7620 250510W 250410U 250310U	T/R/W/SL Series Li-Ion Battery 6-cell T/R/W/SL Series Li-Ion Battery 9-cell Advanced Ultrabay Battery II 3-cell ThinkPad External Battery Charger ThinkPad 90W AC Adapter 90W Slim AC/DC Combo Adapter ThinkPad Business Topload Case ThinkPad Business Backpack ThinkPad Deluxe Expander Case ThinkPad Executive Leather Case ThinkVision® L1700p 17" Monitor ThinkVision L1940p Wide 19" Monitor ThinkVision L2240p Wide 22" Monitor ThinkVision L2440p Wide 24" Monitor Other accessories at lenovo.com/accessories	40Y6799 40Y6797 43R9250 40Y7625 40Y7659 41N8460 43R2476 43R2482 43R2478 43R2480 9417HE2 4424HB6 4422HB6 4420HB2	65-watt (GMA graphics) AC adapter ThinkPad Roll Cage and Top Cover Roll Cage (one-piece magnesium) ENERGY STAR® 4.0-compliant RoHS-compliant International Warranty Service ¹⁷ 24 hour x 7 day ¹⁸ toll-free support during the warranty period ¹² via 800-426-7378 ThinkPlus™.22 4-year LOR ²⁴ 9x5 NBD 12X5630 ThinkPlus 5-year LOR 9x5 NBD 43R2162 Post-warranty annual maintenance agreements at lenovo.com/thinkplus/warranty								

See footnotes for important warranty information
US model announced May 31, 2007

* Intel Centrino® with vPro™ technology

© Lenovo
(CR3-14) February 2008

ThinkPad® T61 15W 6460 (NVIDIA®) - TopSeller

Personal Systems Reference (PSREF)

Type-model	Proc- essor	GHz	Memory	Wide- screen display	Graphics controller memory	Disk SATA GB ³ rpm	EIDE optical	Mini PCIe 802.11 wireless	Mini PCIe WWAN or Turbo	Card slot	Blue- tooth	Bat- tery cells	Workhorse (W) Global (G) Avail date
6460-66U	T7300	2.00	1GB	15.4" WSXGA+	128MB	160G 5400	DVD±RW	* Intel 11n ²⁸	1G Turbo	/54	Blue	6	Bus 32 July 07
6460-7EU	T7300	2.00	1GB	15.4" WSXGA+	128MB	160G 5400	DVD±RW	* Intel 11n		/54	Blue	6	XP Pro July 07
6460-01U	T7500	2.20	1GB	15.4" WSXGA+	128MB	100G 7200	Combo	* Intel 11n		/54	Blue	6	XP Pro Dec 07
6460-DWU	T8100	2.10	1GB	15.4" WSXGA+	128MB	160G 5400	DVD±RW	* Intel 11n		/54	Blue	6	XP Pro Jan 08
6460-DTU	T8300	2.40	1GB	15.4" WSXGA+	128MB	100G 7200	DVD±RW	* Intel 11n		/54	Blue	6	XP Pro Jan 08
6460-DUU	T8300	2.40	1GB	15.4" WSXGA+	128MB	160G 5400	DVD±RW	* Intel 11n	Verizon	/54	Blue	9	XP Pro Jan 08
6460-EFU	T8100	2.10	2GB	15.4" WSXGA+	128MB	160G 5400	DVD±RW	* Intel 11n		/54	Blue	6	Bus 32 Apr 08
6460-EGU	T8300	2.40	2GB	15.4" WSXGA+	128MB	160G 5400	DVD±RW	* Intel 11n	Verizon	/54	Blue	9	Bus 32 Apr 08
6460-05U	T8100	2.10	2GB	15.4" WSXGA+	128MB	160G 5400	DVD±RW	* Intel 11n		/54	Blue	6	Bus 32 Educ May 08
6460-06U	T5870	2.00	2GB	15.4" WXGA	128MB	160G 7200	DVD±RW	* Intel 4965AG ³²		4-in-1	Blue	9	Bus 32 Educ Aug 08
6460-07U	T8100	2.10	2GB	15.4" WSXGA+	128MB	160G 5400	DVD±RW	* Intel 11n		/54	Blue	6	XP Pro Sep 08
6460-08U	T9300	2.50	3GB	15.4" WSXGA+	128MB	160G 7200	DVD±RW	* Intel 11n		/54	Blue	6	XP Pro Sep 08

• These small and medium business (SMB) models are part of the US TopSeller™ Program

Processor	Intel® Core™ 2 Duo processor T5870, T7300, T7500, T8100, T8300, or T9300 with dual-core , 800MHz system bus, T5870: 2MB L2 cache; T7300/T7500: 4MB L2 cache; T8100/T8300: 3MB L2 cache; T9300: 6MB L2 cache										Preloaded operating system²⁰ - Some: Microsoft® Windows® XP Professional with Vista® COA - Some: Microsoft Windows Vista Business Edition (32-bit) ◇ Vista models: Vista Premium logo			
Memory	1GB, 2GB, or 3GB std / 4GB max ⁷ / PC2-5300 667MHz DDR2, non-parity, dual-channel capable, two 200-pin SO-DIMM sockets; <i>Italics:</i> standard memory in both sockets; no sockets available <i>Non-italics:</i> standard memory in 1 socket; 1 socket available										Preloaded applications¹⁴ (all OSes; only some listed) • Microsoft Office OneNote® 2007 and CD (66U, 05U, 06U models) • Some: Education software - VitalSource Library College Edition - Adobe® Instructor Resource Cntr - Adobe Digital School Collection - Photoshop Elements (and CD) - Premier Elements (and DVD) - Acrobat 8 Professional - Contribute 4 • Rescue and Recovery™ • Access Connections™ • Client Security Solution™ • ThinkVantage Productivity Center • ThinkVantage System Update • Norton Internet Security • PC-Doctor™ (diagnostics) • ThinkPad Utilities • Windows Live™ Toolbar • FingerPrint Software • Microsoft Office 2007 Trial (60-day) • Multimedia Center for Think Offerings (XP Pro DVD±RW models) • Sonic RecordNow and Drive Letter Access (DVD±RW) • Corel® WinDVD® (DVD±RW) • Corel WinDVD Creator (XP Pro DVD±RW models)			
Diskette drive	None (use optional USB-based diskette drive)										Supports ThinkVantage® technologies 90-watt (NVIDIA) AC adapter ThinkPad Roll Cage and Top Cover Roll Cage (one-piece magnesium) ENERGY STAR® 4.0-compliant RoHS-compliant International Warranty Service ¹⁷ 24 hour x 7 day ¹⁸ toll-free support during the warranty period ¹² via 800-426-7378 ThinkPlus™.22 2-year LOR ²⁴ 9x5 NBD 41C9175 ThinkPlus 3-year LOR 9x5 NBD 41C9176 ThinkPlus 4-year LOR 9x5 NBD 41C9177 ThinkPlus 5-year LOR 9x5 NBD 41C9179 ThinkPlus 4-year P&L P/U Depot 41C9178 ThinkPlus 5-year P&L P/U Depot 41C9180			
EIDE Combo	Some: DVD-ROM/CD-RW, 24X/24X/24X/8X ²¹ speed, removable from Ultrabay Slim													
Ultrabay DVD±RW	Some: DVD burner, Slim Burner (41N5643), dual-layer, removable from Ultrabay Slim													
Ultrabay Slim	One modular bay for interchangeable devices (right side), 9.5mm high bay, flat bezel													
Serial ATA disk	100GB⁸ (7200 rpm), 160GB (5400 or 7200 rpm) / SATA 1.5Gb/s, 9.5mm high, removable, upgradable, 9.5mm high bay, supports 2nd disk, ThinkPad Shock Mounted Hard Drive, Active Protection System™													
Widescreen display	Some: 15.4" (391mm) WXGA (1280x800) color , anti-glare, 200 nits, 16:10 aspect ratio, 300:1 contrast ratio Some: 15.4" (391mm) WSXGA+ (1680x1050) color , anti-glare, 200 nits, 16:10 aspect ratio, 500:1 contrast ratio													
Camera	Some: camera on top of screen, 1.3-megapixel, fixed focus, USB 2.0													
Graphics	NVIDIA® Quadro® NVS 140M , PCI Express® x16, 128MB memory, TurboCache, DVI pass-through support to optional Advanced Mini Dock or Advanced Dock													
Keyboard	89-key, ThinkVantage button, spill-resistant, multimedia Fn keys, Windows/Apl keys													
TrackPoint®	TrackPoint® pointing device, "Press-to-Select," Internet Scroll Bar ¹³ , magnifying glass													
Touch pad	UltraNav™ multi-pointing system, touch pad below keyboard, Tap Zones													
ThinkLight™	Illuminates the keyboard to improve visibility in low-light conditions													
Dimensions ³	15.4" models (WxDxH): 14.1" x 10.0" x 1.2–1.4"; 358.4mm x 255mm x 29.8–34.5mm													
Weight ²	with optical drive and battery: starting at 5.9 lb (2.7kg)													
Case material	<i>Top:</i> Super-Elastic PolyCarbonate (SEPC); <i>Bottom:</i> Carbon-Fiber Reinforced Plastic													
Battery - type	Lithium Ion 6-cell or 9-cell / supports unique 2nd battery in Ultrabay Slim													
Battery - life ¹⁰	6-cell: up to 3.9 hr; 9-cell: up to 5.9 hr; 9-cell plus Ultrabay battery: up to 7.9 hr													
Chipset	Mobile Intel PM965 Express Chipset (Memory Controller Hub); ICH8M-Enhanced I/O Controller Hub (SATA 3.0Gb/s, ATA-100 EIDE, PCI Express x1, PCI bus, USB, LPC bus, [Bluetooth], [fingerPrint]) / PCI bus (Ricoh® R5C847 Cardbus/1394/Multicard) / LPC bus (WPCN385 Super I/O, Atmel® 97SC3203 TPM)													
PC Card Std slot	One Type I or Type II slot, CardBus 32-bit													
ExpressCard slot	Some: [/54] One ExpressCard/34 or ExpressCard/54													
Smart Card Read	None													
Multicard Reader	Some: 4-in-1 reader (MultiMediaCard, Mem Stick PRO, Sec Digital, xD-Picture Card™)													
Ports	Three USB 2.0, DB-15 (external VGA monitor), RJ-11 (modem), RJ-45 (ethernet), IEEE 1394 FireWire 400 (4-pin connector; 1394a-2000 standard)													
Wireless antenna	UltraConnect™ II antenna / on-off switch for all wireless radios													
Mini PCI Express	Three Mini PCI Express slots / only 802.11 wireless is customer upgradable													
Intel 4965AG ³²	Some: 11a/b/g wireless ⁴ , Mini PCIe adapter, Intel Wireless WiFi Link 4965AG													
Intel 11n ²⁸	Some: 11a/b/g/n wireless ⁴ , Mini PCIe adapter, Intel Wireless WiFi Link 4965AGN, MIMO 2x3 (Kedron)													
Verizon ¹⁶	Some: Wireless WAN, Sierra Wireless 1xEV-DO Network Adapter, Mini PCIe adapter, EV-DO Rev. A, service contract reqd with Verizon® Wireless													
1G Turbo	Some: Intel Turbo Memory, Mini PCIe adapter, 1GB flash, disk-cache accelerator													
Ultra-Wideband	None (uses Half-Mini PCI Express slot)													
Modem	56K V.92 ⁶ modem in Communications Daughter Card socket													
Bluetooth™	Some: Bluetooth 2.0 wireless, USB 2.0 interface via ICH8M, LED indicator													
Ethernet	Gigabit ethernet, Intel 82566MM Nineveh (PHY), PCIe x1 (GLCI), PXE													
Intel AMT	Intel Active Management Technology (IAMT)													
Audio support	High Definition (HD) Audio, AD1984JCP codec / stereo speakers, 1 watt / volume up, down, mute buttons / internal microphone, microphone input jack, headphone jack													
Security	Power-on password, hard disk password, supervisor password, security keyhole													
Security chip	Trusted Platform Module , Atmel chip, TCG 1.2-compliant													
Fingerprint reader	Fingerprint reader on palm rest , swipe sensor, supports the security chip													
Limited warranty ¹²	3-years/1-yr battery - EasyServ™.19 depot repair service / service upgrades ²² available													
2GB PC2-5300 DDR2 SODIMM (TopSeller)	43R2000	90W Slim AC/DC Combo Adapter	41N8460											
200GB Disk FDE SATA 1.5Gb/s (7200 rpm)	41N5738	Other accessories at lenovo.com/accessories												
Post-warranty annual maintenance agreements at lenovo.com/thinkplus/warranty														

See footnotes for important warranty information

* Intel Centrino® with vPro™ technology

© Lenovo

Ⓜ US models announced August 28, 2008; previous models on Jul 10, Dec 6, 2007, Jan 8, Apr 15, May 13, or Aug 1, 2008

(CR3-9) September 2008

Ⓜ US models withdrawn effective December 2007 or May 2008

ThinkPad® T61 15W (NVIDIA Graphics)

Personal Systems Reference (PSREF)

Proc- Type-model	essor GHz	Memory	Wide- screen display	Graphics controller memory	Disk SATA GB ⁶ rpm	EIDE optical	Mini PCIe 802.11 wireless	Mini PCIe WWAN or Turbo	Card slot	Bat- tery cells	Preload	Workhorse (W) Global (G) Entry (E)	Avail date
6457-4UU T7300	2.00	1GB	15.4" WSXGA+	128MB	80GB 5400	Combo	*Intel 4965AG ³²	None	Smart 6	6	Business32	W G	July 07
6457-6NU T7300	2.00	1GB	15.4" WSXGA+	128MB	80GB 5400	Combo	*Intel 4965AG	None	Smart 6	6	XP Pro	G	July 07
6457-6PU T7500	2.20	1GB	15.4" WSXGA+	128MB	120G 5400	DVD±RW	*Intel 4965AG	None	Smart 9	9	XP Pro	G	July 07
6457-4XU T7500	2.20	1GB	15.4" WSXGA+	128MB	120G 5400	DVD±RW	*Intel 4965AG	None	Smart 9	9	Business32	G	July 07
6457-6DU T7500	2.20	2GB	15.4" WSXGA+	128MB	100G 7200	DVD±RW	*Intel 11a/b/g ³²	None	Smart 9	9	Ultimate 32	G	July 07
6457-98U T7500	2.20	1GB	15.4" WSXGA+	128MB	160G 5400	DVD±RW	*Intel 11n	WWAN upg	/54	9	Business64	Mar	08
Processor	Intel® Core™ 2 Duo processor T7300 or T7500 with dual-core, Intel 64 Technology, Enhanced Intel SpeedStep® technology ¹ , Intel Dynamic Acceleration, Execute Disable Bit, Virtualization Technology, 800MHz system bus, and 4MB shared L2 cache								Preloaded operating system ²⁰				
Memory	1GB or 2GB std / 4GB max ⁷ / PC2-5300 667MHz DDR2, non-parity, dual-channel capable, two 200-pin SO-DIMM sockets; <i>Non-italics</i> : standard memory in 1 socket; 1 socket available								- Some: Microsoft® Windows® XP Professional - Some: Microsoft Windows Vista® Business Edition (32-bit) - Some: Microsoft Windows Vista Business Edition (64-bit) - Some: Microsoft Windows Vista Ultimate Edition (32-bit) ◇ Vista models: Vista Premium logo				
Diskette drive	None (use optional USB-based diskette drive)								Preloaded applications ¹⁴ (all OSes) • Rescue and Recovery™ • Access Connections™ • Client Security Solution™ • ThinkVantage Productivity Center • ThinkVantage System Update • System Migration Assistant • Norton Internet Security (90 days of virus definitions) • Diskeeper™ Home • PC-Doctor™ (diagnostics) • ThinkPad Utilities (Power Manager and Presentation Director) • Adobe® Reader • Windows Live™ Toolbar • Windows Live Search • Picasa from Google • Fingerprint Software (fingerprint models) • Microsoft Office 2007 Trial (60-day) • EarthLink Trial (Vista Ultimate models) • Sonic RecordNow and Drive Letter Access (combo, DVD±RW) • Corel® WinDVD® (combo, DVD±RW) • Corel WinDVD Creator (XP Pro DVD±RW models)				
EIDE Combo	Some: DVD-ROM/CD-RW, 24X/24X/24X/8X ²¹ speed, removable from Ultrabay Slim												
EIDE DVD±RW	Some: DVD burner, Ultrabay Slim Burner (41N5643), dual-layer, removable Ultrabay One modular bay for interchangeable devices (right side), 9.5mm high bay, flat bezel												
Serial ATA disk	80GB ⁸ (5400 rpm), 100GB (7200 rpm), 120GB (5400 rpm), or 160GB (5400 rpm) / SATA 1.5Gb/s, 9.5mm high, removable, upgradable, 9.5mm high bay, supports 2nd disk, ThinkPad Shock Mounted Hard Drive, Active Protection System™												
Widescreen display	15.4" (391mm) WSXGA+ (1680x1050) color, anti-glare, 200 nits, 16:10 aspect ratio, 500:1 contrast ratio								Supports ThinkVantage® technologies				
Camera	None												
Graphics	NVIDIA® Quadro® NVS 140M, PCI Express® x16, 128MB memory, TurboCache, DVI pass-through support to optional Advanced Mini Dock or Advanced Dock												
Keyboard	89-key, ThinkVantage button, spill-resistant, multimedia Fn keys, Windows/Apl keys												
TrackPoint®	TrackPoint® pointing device, "Press-to-Select," Internet Scroll Bar ¹³ , magnifying glass												
Touch pad	UltraNav™ multi-pointing system, touch pad below keyboard, Tap Zones												
ThinkLight™	Illuminates the keyboard to improve visibility in low-light conditions												
Dimensions ³	15.4" models (WxDxH): 14.1" x 10.0" x 1.2–1.4"; 358.4mm x 255mm x 29.8–34.5mm with optical drive and battery: starting at 5.9 lb (2.7kg)												
Weight ²	Top: Super-Elastic PolyCarbonate (SEPC); Bottom: Carbon-Fiber Reinforced Plastic												
Case material	Lithium Ion 6-cell or 9-cell / supports unique 2nd battery in Ultrabay Slim												
Battery - type	6-cell: up to 3.9 hr; 9-cell: up to 5.9 hr; 9-cell plus Ultrabay battery: up to 7.9 hr												
Battery - life ¹⁰													
Chipset	Mobile Intel PM965 Express Chipset (Memory Controller Hub); ICH8M-Enhanced I/O Controller Hub (SATA 3.0Gb/s, ATA-100 EIDE, PCI Express x1, PCI bus, USB, LPC bus, [Bluetooth], [fingerprint]) / PCI bus (Ricoh® R5C847 Cardbus/1394/Multicard) / LPC bus (WPCN385 Super I/O, Atmel® 97SC3203 TPM)												
PC Card	One slot (Type I, Type II), CardBus 32-bit												
ExpressCard/54	Some: [/54] One slot (ExpressCard/34, ExpressCard/54)												
Smart Card Read	Some: Smart Card Reader												
Multicard Reader	4-in-1 reader (MultiMediaCard, Memory Stick® PRO™, Secure Digital, xD-Picture Card™)												
Ports	Three USB 2.0, DB-15 (external VGA monitor), RJ-11 (modem), RJ-45 (ethernet), IEEE 1394 FireWire 400 (4-pin connector; 1394a-2000 standard)												
Wireless antenna	UltraConnect™ II antenna / on-off switch for all wireless radios												
Mini PCI Express	Three Mini PCI Express slots												
Intel 11a/b/g ³²	Some: 11a/b/g wireless ⁴ , Mini PCIe adapter, Intel PRO/Wireless 3945ABG												
Intel 4965AG ³²	Some: 11a/b/g wireless ⁴ , Mini PCIe adapter, Intel Wireless WiFi Link 4965AG												
Intel 11n ²⁸	Some: 11a/b/g/n wireless ⁴ , Mini PCIe adapter, Intel Wireless WiFi Link 4965AGN, MIMO 2x3 (Kedron)												
WWAN upg	Some: Wireless WAN upgradable, requires Verizon® EV-DO Rev. A Mini PCIe (43R1818)												
Turbo Memory	None												
UWB	None (uses Half-Mini PCI Express slot)												
Modem	56K V.92 ⁶ modem in Communications Daughter Card socket												
Bluetooth™	Bluetooth 2.0 wireless, USB 2.0 interface via ICH8M, LED indicator												
Ethernet	Gigabit ethernet, Intel 82566MM Nineveh (PHY), PCIe x1 (GLCI), PXE												
Intel AMT	Intel Active Management Technology (IAMT)												
Audio support	High Definition (HD) Audio, AD1984JCP codec / stereo speakers, 1 watt / volume up, down, mute buttons / internal microphone, microphone input jack, headphone jack												
Security	Power-on password, hard disk password, supervisor password, security keyhole												
Security chip	Trusted Platform Module, Atmel chip, TCG 1.2-compliant												
Fingerprint reader	Fingerprint reader on palm rest, swipe sensor, supports the security chip												
Limited warranty ¹²	3-years/1-yr battery - EasyServ™ ¹⁹ onsite pickup and delivery / service upgrades ²² avail												
1GB PC2-5300 DDR2 SODIMM	40Y7734			T/R/W/SL Series Li-Ion Battery 6-cell		40Y6799		ThinkPlus 4-year LOR 9x5 NBD					
2GB PC2-5300 DDR2 SODIMM	40Y7735			T/R/W/SL Series Li-Ion Battery 9-cell		40Y6797		ThinkPlus 5-year LOR 9x5 NBD					
ThinkPad DVD Ultrabay Slim Burner (flat)	41N5643			Advanced Ultrabay Battery II 3-cell		43R9250		ThinkPlus 4-year P&L P/U Depot					
Serial Hard Drive Ultrabay Slim Adapter (flat)	40Y8725			ThinkPad 90W AC Adapter		40Y7659		ThinkPlus 5-year P&L P/U Depot					
128GB SSD SATA 3.0Gb/s 1.8" (2.5" cover)	43N3406			90W Slim AC/DC Combo Adapter		41N8460		ThinkPlus 5-year P&L P/U Depot					
200GB Disk FDE SATA 1.5Gb/s (7200 rpm)	41N5738			ThinkPad Deluxe Expander Case		43R2478		ThinkPlus 5-year P&L P/U Depot					
USB 2.0 Super Multi-Burner Drive	41N5565			ThinkPad Executive Leather Case		43R2480		Post-warranty annual maintenance agreements at					
USB 2.0 Lenovo Enhanced Port Replicator	43R8770			ThinkVision® L1940p Wide 19" Monitor		4424HB6		lenovo.com/thinkplus/warranty					
ThinkPad Advanced Mini Dock	250410U			ThinkVision L2240p Wide 22" Monitor		4422HB6							
ThinkPad Advanced Dock	250310U			ThinkVision L2440p Wide 24" Monitor		4420HB2							
Other accessories on O-T61 sheet													

See footnotes for important warranty information

US model announced March 25, 2008;

previous models on July 10, 2007

US models withdrawn effective May 2008

* Intel Centrino® processor technology

* Intel Centrino with vPro™ technology

© Lenovo

(CR3-5) March 2008

ThinkPad® T61 15W 6458 (NVIDIA) - Onsite

Personal Systems Reference (PSREF)

Type-model	Proc- essor	GHz	Memory	Wide- screen display	Graphics controller memory	Disk SATA GB ³ rpm	EIDE optical	Mini PCIe 802.11 wireless	Mini PCIe WWAN or Turbo	Card slot	Bat- tery Blue- tooth cells	Preload	Workhorse (W) Global (G) GMP (P)	Avail date
6458-4UU	T7300	2.00	1GB	15.4" WSXGA+	128MB	80GB 5400	Combo	*Intel 4965AG ³²	None	Smart	Blue 6	Business32	W G P	July 07
6458-6QU	T7500	2.20	1GB	15.4" WSXGA+	128MB	120GB 5400	DVD±RW	*Intel 4965AG	None	Smart	Blue 9	Business32	W G P	July 07

• These models are part of the Global Models Plus program with limited onsite service²⁴ 3-year limited warranty

Positioning	<i>Premiere performance; two spindles</i>													
Processor	Intel® Core™ 2 Duo processor T7300 or T7500 with dual-core, Intel 64 Technology, Enhanced Intel SpeedStep® technology ¹ , Intel Dynamic Acceleration, Execute Disable Bit, Virtualization Technology, 800MHz system bus, and 4MB shared L2 cache											Preloaded operating system ²⁰ - Microsoft® Windows® Vista® Business Edition (32-bit) ◇ Vista Premium logo		
Memory	1GB std / 4GB max ⁷ / PC2-5300 667MHz DDR2, non-parity, dual-channel capable, two 200-pin SO-DIMM sockets; <i>Non-italics:</i> standard memory in 1 socket; 1 socket available											Preloaded applications ¹⁴ • Rescue and Recovery™ • Access Connections™ • Client Security Solution™ • ThinkVantage Productivity Center • ThinkVantage System Update • System Migration Assistant • Norton Internet Security (90 days of virus definitions) • Diskeeper™ Home • PC-Doctor™ (diagnostics) • ThinkPad Utilities (Power Manager and Presentation Director) • Adobe® Reader • Windows Live™ Toolbar • Windows Live Search • Picasa from Google • Fingerprint Software (fingerprint models) • Microsoft Office 2007 Trial (60-day) • EarthLink Trial (Vista Ultimate models) • Sonic RecordNow and Drive Letter Access (combo) • Corel® WinDVD® (combo)		
Diskette drive	None (use optional USB-based diskette drive)													
EIDE Combo	<i>Some:</i> DVD-ROM/CD-RW, 24X/24X/24X/8X ²¹ speed, removable from Ultrabay Slim													
EIDE DVD±RW	<i>Some:</i> DVD burner, Super Multi-Burner (40Y8623) dual-layer, removable Ultrabay Slim													
Ultrabay Slim	One modular bay for interchangeable devices (right side), 9.5mm high bay, flat bezel													
Serial ATA disk	80GB ⁸ (5400 rpm) or 120GB (5400 rpm) / SATA 1.5Gb/s, 9.5mm high, removable, upgradable, 9.5mm high bay, supports 2nd disk, ThinkPad Shock Mounted Hard Drive, Active Protection System™													
Widescreen display	15.4" (391mm) WSXGA+ (1680x1050) color, anti-glare, 200 nits, 16:10 aspect ratio, 500:1 contrast ratio													
Camera	None													
Graphics	NVIDIA® Quadro® NVS 140M, PCI Express® x16, 128MB memory, TurboCache, DVI pass-through support to optional Advanced Mini Dock or Advanced Dock													
Keyboard	89-key, ThinkVantage button, spill-resistant, multimedia Fn keys, Windows/Appl keys													
TrackPoint®	TrackPoint® pointing device, "Press-to-Select," Internet Scroll Bar ¹³ , magnifying glass													
Touch pad	UltraNav™ multi-pointing system, touch pad below keyboard, Tap Zones													
ThinkLight™	Illuminates the keyboard to improve visibility in low-light conditions													
Dimensions ³	15.4" models (WxDxH): 14.1" x 10.0" x 1.2–1.4"; 358.4mm x 255mm x 29.8–34.5mm													
Weight ²	with optical drive and battery; starting at 5.9 lb (2.7kg)													
Case material	Top: Super-Elastic PolyCarbonate (SEPC); Bottom: Carbon-Fiber Reinforced Plastic													
Battery - type	Lithium Ion 6-cell or 9-cell / supports unique 2nd battery in Ultrabay Slim													
Battery - life ¹⁰	6-cell: up to 3.9 hr; 9-cell: up to 5.9 hr; 9-cell plus Ultrabay battery: up to 7.9 hr													
Chipset	Mobile Intel PM965 Express Chipset (Memory Controller Hub); ICH8M-Enhanced I/O Controller Hub (SATA 3.0Gb/s, ATA-100 EIDE, PCI Express x1, PCI bus, USB, LPC bus, [Bluetooth], [fingerprint]) / PCI bus (Ricoh® R5C847 Cardbus/1394/Multicard) / LPC bus (WPCN385 Super I/O, Atmel® 97SC3203 TPM)													
PC Card	One slot (Type I, Type II), CardBus 32-bit													
ExpressCard slot	None													
Smart Card Reader	Smart Card Reader													
Multicard Reader	4-in-1 reader (MultiMediaCard, Memory Stick® PRO™, Secure Digital, xD-Picture Card™)													
Ports	Three USB 2.0, DB-15 (external VGA monitor), RJ-11 (modem), RJ-45 (ethernet), IEEE 1394 FireWire 400 (4-pin connector; 1394a-2000 standard)													
Wireless antenna	UltraConnect™ II antenna / on-off switch for all wireless radios													
Mini PCI Express	Three Mini PCI Express slots / only 802.11 wireless is customer upgradable													
Intel 4965AG ³²	11a/b/g wireless ⁴ , Mini PCIe adapter, Intel Wireless WiFi Link 4965AG													
WWAN	None													
Turbo Memory	None													
UWB	None (uses Half-Mini PCI Express slot)													
Modem	56K V.92 ⁶ modem in Communications Daughter Card socket													
Bluetooth™	Bluetooth 2.0 wireless, USB 2.0 interface via ICH8M, LED indicator													
Ethernet	Gigabit ethernet, Intel 82566MM Nineveh (PHY), PCIe x1 (GLCI), PXE													
Intel AMT	Intel Active Management Technology (IAMT)													
Audio support	High Definition (HD) Audio, AD1984JCP codec / stereo speakers, 1 watt / volume up, down, mute buttons / internal microphone, microphone input jack, headphone jack													
Security	Power-on password, hard disk password, supervisor password, security keyhole													
Security chip	Trusted Platform Module, Atmel chip, TCG 1.2-compliant													
Fingerprint reader	Fingerprint reader on palm rest, swipe sensor, supports the security chip													
Limited warranty ¹²	3-years/1-year battery, limited onsite service ²⁴ , 8 am - 5 pm, Mon - Fri coverage excluding holidays, next business day response time / service upgrades ²² available													
1GB PC2-5300 DDR2 SODIMM	40Y7734	T/R/W/SL Series Li-Ion Battery 6-cell	40Y6799											
2GB PC2-5300 DDR2 SODIMM	40Y7735	T/R/W/SL Series Li-Ion Battery 9-cell	40Y6797											
ThinkPad DVD Ultrabay Slim Burner (flat)	41N5643	Advanced Ultrabay Battery II 3-cell	43R9250											
128GB SSD SATA 3.0Gb/s 1.8" (2.5" cover)	43N3406	ThinkPad 90W AC Adapter	40Y7659											
320GB Disk SATA 1.5Gb/s (5400 rpm)	43N3403	90W Slim AC/DC Combo Adapter	41N8460											
USB 2.0 Security Memory Key 4GB	41U5120	ThinkPad Business Topload Case	43R2476											
USB 2.0 Super Multi-Burner Drive	41N5565	ThinkPad Business Backpack	43R2482											
USB 2.0 Lenovo Enhanced Port Replicator	43R8770	ThinkPad Deluxe Expander Case	43R2478											
ThinkPad Convertible Monitor Stand	40Y7620	ThinkPad Executive Leather Case	43R2480											
ThinkPad Essential Port Replicator	250510W	ThinkVision® L1940p Wide 19" Monitor	4424HB6											
ThinkPad Advanced Mini Dock	250410U	ThinkVision L2240p Wide 22" Monitor	4422HB6											
ThinkPad Advanced Dock	250310U	ThinkVision L2440x Wide 24" Monitor	4421HB2											
Other accessories on O-T61 sheet	Other accessories at lenovo.com/accessories													
											Supports ThinkVantage® technologies			
											90-watt (NVIDIA) AC adapter ThinkPad Roll Cage and Top Cover Roll Cage (one-piece magnesium) ENERGY STAR® 4.0-compliant RoHS-compliant International Warranty Service ¹⁷ 24 hour x 7 day ¹⁸ toll-free support during the warranty period ¹² via 800-426-7378			
											ThinkPlus™.22 4-year LOR ²⁴ 9x5 NBD 12X5630 ThinkPlus 5-year LOR 9x5 NBD 43R2162 Post-warranty annual maintenance agreements at lenovo.com/thinkplus/warranty			

See footnotes for important warranty information
US models announced July 10, 2007

* Intel Centrino® with vPro™ technology

© Lenovo
(CR3-12) February 2008

ThinkPad® T61 15W 6457 (NVIDIA) - Education (EasyServ)

Personal Systems Reference (PSREF)

Proc- Type-model	essor GHz	Memory	Wide- screen display	Graphics controller memory	Disk SATA GB ⁵ rpm	EIDE optical	Mini PCIe 802.11 wireless	Mini PCIe WWAN or Turbo Card slot	Bat- tery cells	Educ pre- load	Limited warranty ¹²	Vista preload	Avail date
6457-4JU	T7300	2.00 1GB	15.4" WSXGA+	128MB	100G 7200	DVD±RW	11a/b/g ³²	None	/54	9	HE	EasyServ Business32	July 07
<p>• This model has an EasyServ™¹⁹ depot repair service 3-year limited warranty</p> <p>Educational models are available only to public or private K-12 or higher accredited schools organized and operated exclusively for educational purposes for use by qualified students and teachers.</p>													
Positioning Processor	<p><i>Premiere performance; two spindles</i> Intel® Core™ 2 Duo processor T7300 with dual-core, Intel 64 Technology, Enhanced Intel SpeedStep® technology¹, Intel Dynamic Acceleration, Execute Disable Bit, Virtualization Technology, 800MHz system bus; and 4MB shared L2 cache</p>										<p>Preloaded operating system²⁰ - Microsoft® Windows® Vista® Business Edition (32-bit) ⇨ Vista Premium logo</p>		
Memory	<p>1GB std / 4GB max⁷ / PC2-5300 667MHz DDR2, non-parity, dual-channel capable, two 200-pin SO-DIMM sockets; <i>Non-italics:</i> standard memory in 1 socket; 1 socket available</p>										<p>Preloaded applications¹⁴ • Microsoft Office OneNote® 2007 (and CD) • (HE): Higher education software - VitalSource Library College Edition - Adobe® Instructor Resource Center - Adobe Photoshop Elements 5 (and CD) - Adobe Premier Elements 3 (and DVD) • Rescue and Recovery™ • Access Connections™ • Client Security Solution™ • ThinkVantage Productivity Center • ThinkVantage System Update • System Migration Assistant • Norton Internet Security™ (90 days of virus definitions) • Diskeeper® Home • PC-Doctor™ (diagnostics) • ThinkPad Utilities (Power Manager and Presentation Director) • Adobe Reader • Windows Live™ Toolbar • Windows Live Search • Picasa from Google • Fingerprint Software (fingerprint models) • Microsoft Office 2007 Trial (60-day) • Sonic RecordNow and Drive Letter Access (DVD±RW) • Corel® WinDVD® (DVD±RW)</p>		
Diskette drive EIDE DVD±RW Ultrabay Slim Serial ATA disk	<p>None (use optional USB-based diskette drive) DVD burner, Ultrabay Slim Burner (41N5643), dual-layer, removable from Ultrabay Slim One modular bay for interchangeable devices (right side), 9.5mm high bay, flat bezel 100GB⁸ (7200 rpm) / SATA 1.5Gb/s, 9.5mm high, removable, upgradable, 9.5mm high bay, supports 2nd disk, ThinkPad Shock Mounted Hard Drive, Active Protection System™</p>												
Widescreen display Camera	<p>15.4" (391mm) WSXGA+ (1680x1050) color, anti-glare, 200 nits, 16:10 aspect ratio, 500:1 contrast ratio None</p>												
Graphics	<p>NVIDIA® Quadro® NVS 140M, PCI Express® x16, 128MB memory, TurboCache, DVI pass-through support to optional Advanced Mini Dock or Advanced Dock</p>												
Keyboard TrackPoint® Touch pad ThinkLight™	<p>89-key, ThinkVantage button, spill-resistant, multimedia Fn keys, Windows/Appl keys TrackPoint® pointing device, "Press-to-Select," Internet Scroll Bar¹³, magnifying glass UltraNav™ multi-pointing system, touch pad below keyboard, Tap Zones Illuminates the keyboard to improve visibility in low-light conditions</p>												
Dimensions ³ Weight ² Case material Battery - type Battery - life ¹⁰	<p><i>15.4" models (WxDxH):</i> 14.1" x 10.0" x 1.2–1.4"; 358.4mm x 255mm x 29.8–34.5mm with optical drive and battery; starting at 5.9 lb (2.7kg) <i>Top:</i> Super-Elastic PolyCarbonate (SEPC); <i>Bottom:</i> Carbon-Fiber Reinforced Plastic Lithium Ion 9-cell / supports unique 2nd battery in Ultrabay Slim <i>9-cell:</i> up to 5.9 hr; <i>9-cell plus Ultrabay battery:</i> up to 7.9 hr</p>												
Chipset	<p>Mobile Intel PM965 Express Chipset (Memory Controller Hub); ICH8M-Enhanced I/O Controller Hub (SATA 3.0Gb/s, ATA-100 EIDE, PCI Express x1, PCI bus, USB, LPC bus, [Bluetooth], [fingerprint]) / PCI bus (Ricoh® R5C847 Cardbus/1394/Multicard) / LPC bus (WPCN385 Super I/O, Atmel® 97SC3203 TPM)</p>												
PC Card ExpressCard/54 Smart Card Read	<p>One slot (Type I, Type II), CardBus 32-bit One slot (ExpressCard/34, ExpressCard/54) None</p>												
Multicard Reader Ports	<p>4-in-1 reader (MultiMediaCard, Memory Stick® PRO™, Secure Digital, xD-Picture Card™) Three USB 2.0, DB-15 (external VGA monitor), RJ-11 (modem), RJ-45 (ethernet), IEEE 1394 FireWire 400 (4-pin connector; 1394a-2000 standard)</p>												
Wireless antenna Mini PCI Express 11a/b/g ³² WWAN Turbo Memory UWB	<p>UltraConnect™ II antenna / on-off switch for all wireless radios Three Mini PCI Express slots / only 802.11 wireless is customer upgradable 11a/b/g wireless⁴, ThinkPad 11a/b/g Mini PCIe Adapter, Atheros AR5006EX None None None (uses Half-Mini PCI Express slot)</p>												
Modem Bluetooth™ Ethernet Intel AMT Audio support	<p>56K V.92⁶ modem in Communications Daughter Card socket Bluetooth 2.0 wireless, USB 2.0 interface via ICH8M, LED indicator Gigabit ethernet, Intel 82566MM Nineveh (PHY), PCIe x1 (GLCI), PXE Intel Active Management Technology (IAMT) High Definition (HD) Audio, AD1984JCP codec / stereo speakers, 1 watt / volume up, down, mute buttons / internal microphone, microphone input jack, headphone jack</p>										<p>Supports ThinkVantage® technologies</p>		
Security Security chip Fingerprint reader	<p>Power-on password, hard disk password, supervisor password, security keyhole Trusted Platform Module, Atmel chip, TCG 1.2-compliant Fingerprint reader on palm rest, swipe sensor, supports the security chip</p>										<p>90-watt (NVIDIA) AC adapter ThinkPad Roll Cage and Top Cover Roll Cage (one-piece magnesium) ENERGY STAR® 4.0-compliant RoHS-compliant International Warranty Service¹⁷ 24 hour x 7 day¹⁸ toll-free support during the warranty period¹² via 800-426-7378</p>		
Limited warranty ¹²	<p>3-years/1-yr battery - EasyServ™¹⁹ depot repair service / service upgrades²² available</p>												
1GB PC2-5300 DDR2 SODIMM	40Y7734			T/R/W/SL Series Li-Ion Battery 6-cell			40Y6799			ThinkPlus™. ²² 2-year LOR ²⁴ 9x5 NBD			
2GB PC2-5300 DDR2 SODIMM	40Y7735			T/R/W/SL Series Li-Ion Battery 9-cell			40Y6797			41C9175			
ThinkPad DVD Ultrabay Slim Burner (flat)	41N5643			Advanced Ultrabay Battery II 3-cell			43R9250			ThinkPlus 3-year LOR 9x5 NBD			
Serial Hard Drive Ultrabay Slim Adapter (flat)	40Y8725			ThinkPad External Battery Charger			40Y7625			41C9176			
128GB SSD SATA 3.0Gb/s 1.8" (2.5" cover)	43N3406			ThinkPad 90W AC Adapter			40Y7659			ThinkPlus 4-year LOR 9x5 NBD			
200GB Disk FDE SATA 1.5Gb/s (7200 rpm)	41N5738			90W Slim AC/DC Combo Adapter			41N8460			41C9177			
250GB Disk 9.5mm SATA 1.5Gb/s (5400 rpm)	43R8152			ThinkPad Business Topload Case			43R2476			ThinkPlus 5-year LOR 9x5 NBD			
320GB Disk SATA 1.5Gb/s (5400 rpm)	43N3403			ThinkPad Business Backpack			43R2482			41C9179			
USB 2.0 Ultra Secure Memory Key 8GB	45J5918			ThinkPad Deluxe Expander Case			43R2478			ThinkPlus 4-year P&L P/U Depot			
USB 2.0 Super Multi-Burner Drive	41N5565			ThinkVision® L1700p 17" Monitor			9417HE2			41C9178			
ThinkPad Essential Port Replicator	250510W			ThinkVision L1940p Wide 19" Monitor			4424HB6			ThinkPlus 5-year P&L P/U Depot			
ThinkPad Advanced Mini Dock	250410U			ThinkVision L2240p Wide 22" Monitor			4422HB6			41C9180			
ThinkPad Advanced Dock	250310U			ThinkVision L2440x Wide 24" Monitor			4421HB2			Post-warranty annual maintenance agreements at			
Other accessories on O-T61 sheet											<p>lenovo.com/thinkplus/warranty</p>		

See footnotes for important warranty information
 US model announced on July 10, 2007

© Lenovo
 (CR3-7) February 2008

ThinkPad® T61 15W (NVIDIA Graphics) - Education (Onsite)

Personal Systems Reference (PSREF)

Proc- Type-model	essor GHz	Memory	Wide- screen display	Graphics controller memory	Disk SATA GB ³ rpm	EIDE optical	Mini PCIe 802.11 wireless	Mini PCIe WWAN or Turbo Card slot	Bat- tery cells	Educ pre- load	Limited warranty ¹²	Vista preload	Avail date
6458-4JU	T7300	2.00 1GB	15.4" WSXGA+	128MB	100G 7200	DVD±RW	11a/b/g ³²	None /54	9	HE	Onsite	Business32	July 07
<p>• This model has a limited onsite service²⁴ 3-year limited warranty Educational models are available only to public or private K-12 or higher accredited schools organized and operated exclusively for educational purposes for use by qualified students and teachers.</p>													
Positioning Processor	<p><i>Premiere performance; two spindles</i> Intel® Core™ 2 Duo processor T7300 with dual-core, Intel 64 Technology, Enhanced Intel SpeedStep[®] technology¹, Intel Dynamic Acceleration, Execute Disable Bit, Virtualization Technology, 800MHz system bus, and 4MB shared L2 cache</p>										<p>Preloaded operating system²⁰ - Microsoft® Windows® Vista™ Business Edition (32-bit) ⇨ Vista Premium logo</p>		
Memory	<p>1GB std / 4GB max⁷ / PC2-5300 667MHz DDR2, non-parity, dual-channel capable, two 200-pin SO-DIMM sockets; <i>Non-italics:</i> standard memory in 1 socket; 1 socket available</p>										<p>Preloaded applications¹⁴ • Microsoft Office OneNote® 2007 (and CD) • (HE): Higher education software - VitalSource Library College Edition - Adobe® Instructor Resource Center - Adobe Photoshop Elements 5 (and CD) - Adobe Premier Elements 3 (and DVD) • Rescue and Recovery™ • Access Connections™ • Client Security Solution™ • ThinkVantage Productivity Center • ThinkVantage System Update • System Migration Assistant • Norton Internet Security (90 days of virus definitions) • Diskeeper™ Home • PC-Doctor™ (diagnostics) • ThinkPad Utilities (Power Manager and Presentation Director) • Adobe Reader • Windows Live™ Toolbar • Windows Live Search • Picasa from Google • Fingerprint Software (fingerprint models) • Microsoft Office 2007 Trial (60-day) • Sonic RecordNow and Drive Letter Access (DVD±RW) • Corel® WinDVD® (DVD±RW)</p>		
Diskette drive	None (use optional USB-based diskette drive)												
EIDE DVD±RW	DVD burner, Ultrabay Slim Burner (41N5643), dual-layer, removable from Ultrabay Slim												
Ultrabay Slim	One modular bay for interchangeable devices (right side), 9.5mm high bay, flat bezel												
Serial ATA disk	100GB⁸ (7200 rpm) / SATA 1.5Gb/s, 9.5mm high, removable, upgradable, 9.5mm high bay, supports 2nd disk, ThinkPad Shock Mounted Hard Drive, Active Protection System™												
Widescreen display	15.4" (391mm) WSXGA+ (1680x1050) color , anti-glare, 200 nits, 16:10 aspect ratio, 500:1 contrast ratio												
Camera	None												
Graphics	NVIDIA® Quadro® NVS 140M , PCI Express® x16, 128MB memory, TurboCache, DVI pass-through support to optional Advanced Mini Dock or Advanced Dock												
Keyboard	89-key, ThinkVantage button, spill-resistant, multimedia Fn keys, Windows/Appl keys												
TrackPoint®	TrackPoint® pointing device, "Press-to-Select," Internet Scroll Bar ¹³ , magnifying glass												
Touch pad	UltraNav™ multi-pointing system, touch pad below keyboard, Tap Zones												
ThinkLight™	Illuminates the keyboard to improve visibility in low-light conditions												
Dimensions ³	<i>15.4" models (WxDxH):</i> 14.1" x 10.0" x 1.2–1.4"; 358.4mm x 255mm x 29.8–34.5mm												
Weight ²	with optical drive and battery: starting at 5.9 lb (2.7kg)												
Case material	<i>Top:</i> Super-Elastic PolyCarbonate (SEPC); <i>Bottom:</i> Carbon-Fiber Reinforced Plastic												
Battery - type	Lithium Ion 9-cell / supports unique 2nd battery in Ultrabay Slim												
Battery - life ¹⁰	<i>9-cell:</i> up to 5.9 hr; <i>9-cell plus Ultrabay battery:</i> up to 7.9 hr												
Chipset	Mobile Intel PM965 Express Chipset (Memory Controller Hub); ICH8M-Enhanced I/O Controller Hub (SATA 3.0Gb/s, ATA-100 EIDE, PCI Express x1, PCI bus, USB, LPC bus, [Bluetooth], [fingerprint]) / PCI bus (Ricoch® R5C847 Cardbus/1394/Multicard) / LPC bus (WPCN385 Super I/O, Atmel® 97SC3203 TPM)												
PC Card	One slot (Type I, Type II), CardBus 32-bit												
ExpressCard/54	One slot (ExpressCard/34, ExpressCard/54)												
Smart Card Read	None												
Multicard Reader	4-in-1 reader (MultiMediaCard, Memory Stick® PRO™, Secure Digital, xD-Picture Card™)												
Ports	Three USB 2.0, DB-15 (external VGA monitor), RJ-11 (modem), RJ-45 (ethernet), IEEE 1394 FireWire 400 (4-pin connector; 1394a-2000 standard)												
Wireless antenna	UltraConnect™ II antenna / on-off switch for all wireless radios												
Mini PCI Express	Three Mini PCI Express slots / only 802.11 wireless is customer upgradable												
11a/b/g ³²	11a/b/g wireless ⁴ , ThinkPad 11a/b/g Mini PCIe Adapter, Atheros AR5006EX												
WWAN	None												
Turbo Memory	None												
UWB	None (uses Half-Mini PCI Express slot)												
Modem	56K V.92 ⁶ modem in Communications Daughter Card socket												
Bluetooth™	Bluetooth 2.0 wireless, USB 2.0 interface via ICH8M, LED indicator												
Ethernet	Gigabit ethernet, Intel 82566MM Nineveh (PHY), PCIe x1 (GLCI), PXE												
Intel AMT	Intel Active Management Technology (IAMT)												
Audio support	High Definition (HD) Audio, AD1984JCP codec / stereo speakers, 1 watt / volume up, down, mute buttons / internal microphone, microphone input jack, headphone jack												
Security	Power-on password, hard disk password, supervisor password, security keyhole												
Security chip	Trusted Platform Module , Atmel chip, TCG 1.2-compliant												
Fingerprint reader	Fingerprint reader on palm rest , swipe sensor, supports the security chip												
Limited warranty ¹²	3-years/1-year battery, limited onsite service²⁴ , 8 am - 5 pm, Mon - Fri coverage excluding holidays, next business day response time												
1GB PC2-5300 DDR2 SODIMM	40Y7734			T/R/W/SL Series Li-Ion Battery 6-cell			40Y6799			Supports ThinkVantage® technologies			
2GB PC2-5300 DDR2 SODIMM	40Y7735			T/R/W/SL Series Li-Ion Battery 9-cell			40Y6797			90-watt (NVIDIA) AC adapter			
Serial Hard Drive Ultrabay Slim Adapter (flat)	40Y8725			Advanced Ultrabay Battery II 3-cell			43R9250			ThinkPad Roll Cage and Top Cover			
128GB SSD SATA 3.0Gb/s 1.8" (2.5" cover)	43N3406			ThinkPad External Battery Charger			40Y7625			Roll Cage (one-piece magnesium)			
200GB Disk FDE SATA 1.5Gb/s (7200 rpm)	41N5738			ThinkPad 90W AC Adapter			40Y7659			ENERGY STAR® 4.0-compliant			
250GB Disk 9.5mm SATA 1.5Gb/s (5400 rpm)	43R8152			90W Slim AC/DC Combo Adapter			41N8460			RoHS-compliant			
320GB Disk SATA 1.5Gb/s (5400 rpm)	43N3403			ThinkPad Business Topload Case			43R2476			International Warranty Service ¹⁷			
USB 2.0 Ultra Secure Memory Key 8GB	45J5918			ThinkPad Business Backpack			43R2482			24 hour x 7 day ¹⁸ toll-free support during the warranty period ¹² via 800-426-7378			
USB 2.0 Super Multi-Burner Drive	41N5565			ThinkPad Deluxe Expander Case			43R2478						
USB 2.0 Lenovo Enhanced Port Replicator	43R8770			ThinkVision® L1700p 17" Monitor			9417HE2						
ThinkPad Essential Port Replicator	250510W			ThinkVision L1940p Wide 19" Monitor			4424HB6						
ThinkPad Advanced Mini Dock	250410U			ThinkVision L2240p Wide 22" Monitor			4422HB6			Post-warranty annual maintenance agreements at lenovo.com/thinkplus/warranty			
ThinkPad Advanced Dock	250310U			ThinkVision L2440x Wide 24" Monitor			4421HB2						
Other accessories on O-T61 sheet	Other accessories at lenovo.com/accessories												

See footnotes for important warranty information
 US model announced July 10, 2007

© Lenovo
 (CR3-8) July 2007

ThinkPad® T61u 15W 6463 (GMA) - Education (EasyServ)

Personal Systems Reference (PSREF)

Proc- Type-model	Processor GHz	Memory	Wide- screen display	Graphics controller	Disk SATA GB ⁵	rpm	EIDE optical	Mini PCIe 802.11 wireless	Mini PCIe WWAN or Turbo	Card slot	Blue- tooth	Finger print reader	Bat- tery cells	Limited warranty ¹²	Vista preload	Avail date
6463-9RU	T8300	2.40	1GB	15.4" WXGA	GMA 80G	5400	Combo	11a/b/g ³²	None	/54	Blue	Finger	9	EasyServ	Business32	Feb 08
6463-9SU	T9300	2.50	1GB	15.4" WXGA	GMA 100G	7200	DVD±RW	11a/b/g	None	/54	Blue	Finger	9	EasyServ	Business32	Feb 08
6463-05U	T9300	2.50	2GB	15.4" WXGA	GMA 160G	7200	DVD±RW	11a/b/g	None	/54	Blue	Finger	9	EasyServ	Business32	Apr 08

Italic MTM: not a base model for building a custom model

• **These models have an EasyServ™¹⁹ depot repair service 3-year limited warranty**
 Educational models are available only to public or private K-12 or higher accredited schools organized and operated exclusively for educational purposes for use by qualified students and teachers.

Positioning Processor	<i>Premiere performance; two spindles</i> Intel® Core™ 2 Duo processor T8300 or T9300 with dual-core, Intel 64 Technology, Enhanced Intel SpeedStep technology ¹ , Intel Dynamic Acceleration, Execute Disable Bit, Virtualization Technology, 800MHz system bus; T8300: 3MB L2 cache; T9300: 6MB L2 cache	Preloaded operating system²⁰ - Microsoft® Windows® Vista® Business Edition (32-bit) ◇ Vista Basic logo
Memory	1GB or 2GB std / 4GB max ⁷ / PC2-5300 667MHz DDR2, non-parity, dual-channel capable, two 200-pin SO-DIMM sockets; <i>Italics:</i> standard memory in both sockets; no sockets available; <i>Non-italics:</i> standard memory in 1 socket; 1 socket available	Preloaded applications¹⁴ • Microsoft Office OneNote® 2007 (and CD) • Education software - VitalSource Library College Edition - Adobe® Instructor Resource Cntr - Adobe Digital School Collection - Photoshop Elements (and CD) - Premier Elements (and DVD) - Acrobat 8 Professional - Contribute 4 • Rescue and Recovery™ • Access Connections™ • Client Security Solution™ • ThinkVantage Productivity Center • ThinkVantage System Update • System Migration Assistant • Norton Internet Security™ (90 days of virus definitions) • Diskeeper® Home • PC-Doctor™ (diagnostics) • ThinkPad Utilities (Power Manager and Presentation Director) • Adobe Reader • Windows Live™ Toolbar • Windows Live Search • Picasa from Google • Some: Fingerprint Software • Microsoft Office 2007 Trial (60-day) • Sonic RecordNow and Drive Letter Access (Combo, DVD±RW) • Corel® WinDVD® (Combo, DVD±RW)
Diskette drive EIDE Combo EIDE DVD±RW Ultrabay Slim Serial ATA disk	None (use optional USB-based diskette drive) <i>Some:</i> DVD-ROM/CD-RW, 24X/24X/8X ²¹ speed, removable from Ultrabay Slim <i>Some:</i> DVD burner, Slim Burner (41N5643), dual-layer, removable from Ultrabay Slim One modular bay for interchangeable devices (right side), 9.5mm high bay, flat bezel 80GB⁸ (5400 rpm), 100GB (7200 rpm), or 160GB (7200 rpm) / SATA 1.5Gb/s, 9.5mm high, removable, upgradable, 9.5mm high bay, supports 2nd disk, ThinkPad Shock Mounted Hard Drive, Active Protection System™	
Widescreen display Camera	15.4" (391mm) WXGA (1280x800) color , anti-glare, 200 nits, 16:10 aspect ratio, 300:1 contrast ratio None	
Graphics	Intel Graphics Media Accelerator X3100 (GMA X3100) , integrated in GM965, DVI pass-through support to optional Advanced Mini Dock or Advanced Dock	
Keyboard TrackPoint® Touch pad ThinkLight™	89-key, ThinkVantage button, spill-resistant, multimedia Fn keys, Windows/Appl keys TrackPoint® pointing device, "Press-to-Select," Internet Scroll Bar ¹³ , magnifying glass UltraNav™ multi-pointing system, touch pad below keyboard, Tap Zones Illuminates the keyboard to improve visibility in low-light conditions	
Dimensions ³ Weight ² Case material Battery - type Battery - life ¹⁰	<i>15.4" models (WxDxH):</i> 14.1" x 10.0" x 1.2–1.4"; 358.4mm x 255mm x 29.8–34.5mm with optical drive and battery; starting at 5.9 lb (2.7kg) <i>Top:</i> Super-Elastic PolyCarbonate (SEPC); <i>Bottom:</i> Carbon-Fiber Reinforced Plastic Lithium Ion 9-cell / supports unique 2nd battery in Ultrabay Slim <i>9-cell:</i> up to 8.3 hr; <i>9-cell plus Ultrabay battery:</i> up to 9.8 hr	
Chipset	Mobile Intel GM965 Express Chipset (Graphics Memory Controller Hub); ICH8M-Enhanced I/O Controller Hub (SATA 3.0Gb/s, ATA-100 EIDE, PCI Express® x1, PCI bus, USB, LPC bus, [Bluetooth], [fingerprint]) / PCI bus (Ricoch® R5C847 Cardbus/1394/Multicard) / LPC bus (WPCN385 Super I/O, Atmel® 97SC3203 TPM)	
PC Card ExpressCard/54 Smart Card Read Multicard Reader Ports	One slot (Type I, Type II), CardBus 32-bit One slot (ExpressCard/34, ExpressCard/54) None 4-in-1 reader (MultiMediaCard, Mem Stick PRO, Secure Digital, xD-Picture Card™) Three USB 2.0, DB-15 (external VGA monitor), RJ-11 (modem), RJ-45 (ethernet), IEEE 1394 FireWire 400 (4-pin connector; 1394a-2000 standard)	
Wireless antenna Mini PCI Express 11a/b/g ³² WWAN Turbo Memory UWB Modem Bluetooth™ Ethernet Intel AMT Audio support	UltraConnect™ II antenna / on-off switch for all wireless radios Three Mini PCI Express slots / only 802.11 wireless is customer upgradable 11a/b/g wireless ⁴ , ThinkPad 11a/b/g Mini PCIe Adapter, Atheros AR5006EX None None None (uses Half-Mini PCI Express slot) 56K V.92 ⁵ modem in Communications Daughter Card socket <i>Some:</i> Bluetooth 2.0 wireless, USB 2.0 interface via ICH8M, LED indicator Gigabit ethernet, Intel 82566MM Nineveh (PHY), PCIe x1 (GLCI), PXE Intel Active Management Technology (IAMT) High Definition (HD) Audio, AD1984JCP codec / stereo speakers, 1 watt / volume up, down, mute buttons / internal microphone, microphone input jack, headphone jack Power-on password, hard disk password, supervisor password, security keyhole	Supports ThinkVantage® technologies 65-watt (GMA graphics) AC adapter ThinkPad Roll Cage and Top Cover Roll Cage (one-piece magnesium) ENERGY STAR® 4.0-compliant RoHS-compliant International Warranty Service ¹⁷ 24 hour x 7 day ¹⁸ toll-free support during the warranty period ¹² via 800-426-7378
Security Security chip Fingerprint reader	Power-on password, hard disk password, supervisor password, security keyhole Trusted Platform Module , Atmel chip, TCG 1.2-compliant <i>Some:</i> Fingerprint reader on palm rest , swipe sensor, supports the security chip	ThinkPlus™.22 2-year LOR²⁴ 9x5 NBD 41C9175 ThinkPlus 3-year LOR 9x5 NBD 41C9176 ThinkPlus 4-year LOR 9x5 NBD 41C9177 ThinkPlus 5-year LOR 9x5 NBD 41C9179 ThinkPlus 4-year P&L P/U Depot 41C9178 ThinkPlus 5-year P&L P/U Depot 41C9180
Limited warranty ¹²	3-years/1-yr battery - EasyServ™.19 depot repair service / service upgrades²² available	Post-warranty annual maintenance agreements at lenovo.com/thinkplus/warranty

1GB PC2-5300 DDR2 SODIMM	40Y7734	T/R/W/SL Series Li-Ion Battery 6-cell	40Y6799
2GB PC2-5300 DDR2 SODIMM	40Y7735	T/R/W/SL Series Li-Ion Battery 9-cell	40Y6797
ThinkPad DVD Ultrabay Slim Burner (flat)	41N5643	Advanced Ultrabay Battery II 3-cell	43R9250
128GB SSD SATA 3.0Gb/s 1.8" (2.5" cover)	43N3406	ThinkPad External Battery Charger	40Y7625
200GB Disk FDE SATA 1.5Gb/s (7200 rpm)	41N5738	ThinkPad 90W AC Adapter	40Y7659
320GB Disk SATA 1.5Gb/s (5400 rpm)	43N3403	90W Slim AC/DC Combo Adapter	41N8460
USB 2.0 Security Memory Key 4GB	41U5120	ThinkPad Business Topload Case	43R2476
USB 2.0 Lenovo Enhanced Port Replicator	43R8770	ThinkPad Business Backpack	43R2482
ThinkPad Convertible Monitor Stand	40Y7620	ThinkVision® L2240p Wide 22" Monitor	4422HB6
ThinkPad Advanced Dock	250310U	ThinkVision L2440p Wide 24" Monitor	4420HB2
Other accessories on O-T61 sheet		Other accessories at lenovo.com/accessories	

See footnotes for important warranty information

US model announced April 10, 2008; previous models on February 19, 2008

© Lenovo
(CR4-2) April 2008

ThinkPad® T61u 15W 6457 (NVIDIA) - Education (EasyServ)

Personal Systems Reference (PSREF)

Type-model	Proc- essor	GHz	Memory	Wide- screen display	Graphics controller memory	Disk SATA GB ⁵ rpm	EIDE optical	Mini PCIe 802.11 wireless	Mini PCIe WWAN or Turbo Card slot	Blue- tooth	Finger print reader	Bat- tery cells	Limited warranty ¹²	Vista preload	Avail date		
6457-DSU	T9300	2.50	1GB	15.4"	WSXGA+	128MB	100G	7200	DVD±RW	11a/b/g ³²	None	/54	Blue	Fing	9	EasyServ Business32	Feb 08
6457-05U	T9300	2.50	2GB	15.4"	WSXGA+	128MB	160G	7200	DVD±RW	11a/b/g	None	/54	Blue	Fing	9	EasyServ Business32	Apr 08
<i>Italic MTM: not a base model for building a custom model</i>																	
<p>• These models have an EasyServ™¹⁹ depot repair service 3-year limited warranty</p> <p>Educational models are available only to public or private K-12 or higher accredited schools organized and operated exclusively for educational purposes for use by qualified students and teachers.</p>																	
Positioning Processor	<p><i>Premiere performance; two spindles</i> Intel® Core™ 2 Duo processor T9300 with dual-core, Intel 64 Technology, Enhanced Intel SpeedStep® technology¹, Intel Dynamic Acceleration, Execute Disable Bit, Virtualization Technology, 800MHz system bus, and 6MB shared L2 cache</p>											<p>Preloaded operating system²⁰ - Microsoft® Windows® Vista® Business Edition (32-bit) ♦ Vista Premium logo</p>					
Memory	<p>1GB or 2GB std / 4GB max⁷ / PC2-5300 667MHz DDR2, non-parity, dual-channel capable, two 200-pin SO-DIMM sockets; <i>Non-italics:</i> standard memory in 1 socket; 1 socket available</p>											<p>Preloaded applications¹⁴ • Microsoft Office OneNote® 2007 (and CD) • Education software - VitalSource Library College Edition - Adobe® Instructor Resource Cntr - Adobe Digital School Collection - Photoshop Elements (and CD) - Premier Elements (and DVD) - Acrobat 8 Professional - Contribute 4 • Rescue and Recovery™ • Access Connections™ • Client Security Solution™ • ThinkVantage Productivity Center • ThinkVantage System Update • System Migration Assistant • Norton Internet Security™ (90 days of virus definitions) • Diskeeper® Home • PC-Doctor™ (diagnostics) • ThinkPad Utilities (Power Manager and Presentation Director) • Adobe Reader • Windows Live™ Toolbar • Windows Live Search • Picasa from Google • Fingerprint Software • Microsoft Office 2007 Trial (60-day) • Sonic RecordNow and Drive Letter Access (DVD±RW) • Corel® WinDVD® (DVD±RW)</p>					
Diskette drive EIDE DVD±RW Ultrabay Slim Serial ATA disk	<p>None (use optional USB-based diskette drive) DVD burner, Ultrabay Slim Burner (41N5643), dual-layer, removable from Ultrabay Slim One modular bay for interchangeable devices (right side), 9.5mm high bay, flat bezel 100GB⁸ (7200 rpm) or 160GB⁸ (7200 rpm) / SATA 1.5Gb/s, 9.5mm high, removable, upgradable, 9.5mm high bay, supports 2nd disk, ThinkPad Shock Mounted Hard Drive, Active Protection System™</p>																
Widescreen display Camera	<p>15.4" (391mm) WSXGA+ (1680x1050) color, anti-glare, 200 nits, 16:10 aspect ratio, 500:1 contrast ratio None</p>																
Graphics	<p>NVIDIA® Quadro® NVS 140M, PCI Express® x16, 128MB memory, TurboCache, DVI pass-through support to optional Advanced Mini Dock or Advanced Dock</p>																
Keyboard TrackPoint® Touch pad ThinkLight™	<p>89-key, ThinkVantage button, spill-resistant, multimedia Fn keys, Windows/Appl keys TrackPoint® pointing device, "Press-to-Select," Internet Scroll Bar¹³, magnifying glass UltraNav™ multi-pointing system, touch pad below keyboard, Tap Zones Illuminates the keyboard to improve visibility in low-light conditions</p>																
Dimensions ³ Weight ² Case material Battery - type Battery - life ¹⁰	<p><i>15.4" models (WxDxH):</i> 14.1" x 10.0" x 1.2–1.4"; 358.4mm x 255mm x 29.8–34.5mm with optical drive and battery: starting at 5.9 lb (2.7kg) <i>Top:</i> Super-Elastic PolyCarbonate (SEPC); <i>Bottom:</i> Carbon-Fiber Reinforced Plastic Lithium Ion 9-cell / supports unique 2nd battery in Ultrabay Slim 9-cell: up to 5.9 hr; 9-cell plus Ultrabay battery: up to 7.9 hr</p>																
Chipset	<p>Mobile Intel PM965 Express Chipset (Memory Controller Hub); ICH8M-Enhanced I/O Controller Hub (SATA 3.0Gb/s, ATA-100 EIDE, PCI Express x1, PCI bus, USB, LPC bus, [Bluetooth], [fingerprint]) / PCI bus (Ricoh® R5C847 Cardbus/1394/Multicard) / LPC bus (WPCN385 Super I/O, Atmel® 97SC3203 TPM) One slot (Type I, Type II), CardBus 32-bit One slot (ExpressCard/34, ExpressCard/54)</p>																
PC Card ExpressCard/54 Smart Card Read Multicard Reader Ports	<p>One slot (Type I, Type II), CardBus 32-bit One slot (ExpressCard/34, ExpressCard/54) None 4-in-1 reader (MultiMediaCard, Memory Stick® PRO™, Secure Digital, xD-Picture Card™) Three USB 2.0, DB-15 (external VGA monitor), RJ-11 (modem), RJ-45 (ethernet), IEEE 1394 FireWire 400 (4-pin connector; 1394a-2000 standard)</p>																
Wireless antenna Mini PCI Express 11a/b/g ³² WWAN Turbo Memory UWB Modem Bluetooth™ Ethernet Intel AMT Audio support	<p>UltraConnect™ II antenna / on-off switch for all wireless radios Three Mini PCI Express slots / only 802.11 wireless is customer upgradable 11a/b/g wireless⁴, ThinkPad 11a/b/g Mini PCIe Adapter, Atheros AR5006EX None None None (uses Half-Mini PCI Express slot) 56K V.92⁶ modem in Communications Daughter Card socket Bluetooth 2.0 wireless, USB 2.0 interface via ICH8M, LED indicator Gigabit ethernet, Intel 82566MM Nineveh (PHY), PCIe x1 (GLCI), PXE Intel Active Management Technology (IAMT) High Definition (HD) Audio, AD1984JCP codec / stereo speakers, 1 watt / volume up, down, mute buttons / internal microphone, microphone input jack, headphone jack Power-on password, hard disk password, supervisor password, security keyhole</p>											<p>Supports ThinkVantage® technologies</p>					
Security Security chip Fingerprint reader	<p>Power-on password, hard disk password, supervisor password, security keyhole Trusted Platform Module, Atmel chip, TCG 1.2-compliant Fingerprint reader on palm rest, swipe sensor, supports the security chip</p>											<p>90-watt (NVIDIA) AC adapter ThinkPad Roll Cage and Top Cover Roll Cage (one-piece magnesium) ENERGY STAR® 4.0-compliant RoHS-compliant International Warranty Service¹⁷ 24 hour x 7 day¹⁸ toll-free support during the warranty period¹² via 800-426-7378</p>					
Limited warranty ¹²	<p>3-years/1-yr battery - EasyServ™¹⁹ depot repair service / service upgrades²² available</p>											<p>ThinkPlus™.²² 2-year LOR²⁴ 9x5 NBD 41C9175 ThinkPlus 3-year LOR 9x5 NBD 41C9176 ThinkPlus 4-year LOR 9x5 NBD 41C9177 ThinkPlus 5-year LOR 9x5 NBD 41C9179 ThinkPlus 4-year P&L P/U Depot 41C9178 ThinkPlus 5-year P&L P/U Depot 41C9180 Post-warranty annual maintenance agreements at lenovo.com/thinkplus/warranty</p>					
1GB PC2-5300 DDR2 SODIMM	40Y7734		T/R/W/SL Series Li-Ion Battery 6-cell		40Y6799												
2GB PC2-5300 DDR2 SODIMM	40Y7735		T/R/W/SL Series Li-Ion Battery 9-cell		40Y6797												
ThinkPad DVD Ultrabay Slim Burner (flat)	41N5643		Advanced Ultrabay Battery II 3-cell		43R9250												
Serial Hard Drive Ultrabay Slim Adapter (flat)	40Y8725		ThinkPad External Battery Charger		40Y7625												
128GB SSD SATA 3.0Gb/s 1.8" (2.5" cover)	43N3406		ThinkPad 90W AC Adapter		40Y7659												
200GB Disk FDE SATA 1.5Gb/s (7200 rpm)	41N5738		90W Slim AC/DC Combo Adapter		41N8460												
250GB Disk 9.5mm SATA 1.5Gb/s (5400 rpm)	43R8152		ThinkPad Business Topload Case		43R2476												
320GB Disk SATA 1.5Gb/s (5400 rpm)	43N3403		ThinkPad Business Backpack		43R2482												
USB 2.0 Ultra Secure Memory Key 8GB	45J5918		ThinkPad Deluxe Expander Case		43R2478												
USB 2.0 Super Multi-Burner Drive	41N5565		ThinkVision® L1700p 17" Monitor		9417HE2												
ThinkPad Convertible Monitor Stand	40Y7620		ThinkVision L1940p Wide 19" Monitor		4424HB6												
ThinkPad Advanced Mini Dock	250410U		ThinkVision L2240p Wide 22" Monitor		4422HB6												
ThinkPad Advanced Dock	250310U		ThinkVision L2440p Wide 24" Monitor		4420HB2												
Other accessories on O-T61 sheet			Other accessories at lenovo.com/accessories														

See footnotes for important warranty information

US model announced on April 10, 2008; previous model on February 19, 2008

© Lenovo
(CR4-1) April 2008

ThinkPad® T61p 15W 6460 (NVIDIA) - TopSeller

Personal Systems Reference (PSREF)

Proc- Type-model essor	GHz	Memory	Wide- screen display	Graphics controller memory	Disk SATA GB ³ rpm	EIDE optical	Mini PCIe 802.11 wireless	Mini PCIe WWAN or Turbo	Card slot	Blue- tooth	Bat- tery cells	Workhorse (W) Global (G) Avail Entry (E) date
6460-67U T7500	2.20	2GB	15.4" WUXGA	256MB	100G 7200	DVD±RW	* Intel 11n ²⁸		/54	Blue	9	Ultimate 32 No July 07
6460-8VU T7700	2.40	2GB	15.4" WUXGA	256MB	160G 7200	DVD±RW	* Intel 11n		/54	Blue	9	XP Pro No Oct 07
6460-8WU T7700	2.40	2GB	15.4" WUXGA	256MB	160G 7200	DVD±RW	* Intel 11n	1G Turbo	/54	Blue	9	Business32 No Oct 07
6460-8XU T7700	2.40	4GB	15.4" WUXGA	256MB	200G FDE	DVD±RW	* Intel 11n		/54	Blue	9	Business64 No Oct 07
6460-DVU T9300	2.50	2GB	15.4" WSXGA+	256MB	160G 7200	DVD±RW	* Intel 11n		/54	Blue	9	XP Pro No Jan 08
<ul style="list-style-type: none"> • These small and medium business (SMB) models are part of the US TopSeller™ Program • These models have a 3-year limited warranty¹² 												
Positioning Processor	<i>Premiere performance; two spindles</i> Intel® Core™ 2 Duo processor T7500, T7700, or T9300 with dual-core, Intel 64 Technology, Enhanced Intel SpeedStep® technology ¹ , Intel Dynamic Acceleration, Execute Disable Bit, Virtualization Technology, 800MHz system bus, T7500/T7700: 4MB shared L2 cache; T9300: 6MB shared L2 cache										Preloaded operating system²⁰ - Some: Microsoft® Windows® XP Professional with Vista® COA - Some: Microsoft Windows Vista Ultimate Edition (32-bit) - Some: Microsoft Windows Vista Business Edition (64-bit) ♦ Vista models: Vista Premium logo	
Memory	2GB or 4GB std / 4GB max ⁷ / PC2-5300 667MHz DDR2, non-parity, dual-channel capable, two 200-pin SO-DIMM sockets; <i>Italics:</i> standard memory in both sockets; no sockets available										Preloaded applications¹⁴ (all OSes) • Microsoft Office OneNote® 2007 and CD (Vista models) • Rescue and Recovery™ • Access Connections™ • Client Security Solution™ • ThinkVantage Productivity Center • ThinkVantage System Update • System Migration Assistant • Norton Internet Security (90 days of virus definitions) • Diskeeper™ Home • PC-Doctor™ (diagnostics) • ThinkPad Utilities (Power Manager and Presentation Director) • Adobe® Reader • Windows Live™ Toolbar • Windows Live Search • Picasa from Google • Fingerprint Software (fingerprint models) • Microsoft Office 2007 Trial (60-day) • Multimedia Center for Think Offerings (XP Pro DVD±RW models) • Sonic RecordNow and Drive Letter Access (DVD±RW) • Corel® WinDVD® (DVD±RW) • Corel WinDVD Creator (XP Pro DVD±RW models)	
Diskette drive EIDE DVD±RW Ultrabay Slim Serial ATA disk	None (use optional USB-based diskette drive) DVD burner, Ultrabay Slim Burner (41N5643), dual-layer, removable from Ultrabay Slim One modular bay for interchangeable devices (right side), 9.5mm high bay, flat bezel 100GB⁸ (7200 rpm), 160GB (7200 rpm), or 200GB Full Disk Encryption [FDE] (7200 rpm) / SATA 1.5Gb/s, 9.5mm high, removable, upgradable, 9.5mm high bay, supports 2nd disk, ThinkPad Shock Mounted Hard Drive, Active Protection System™											
Widescreen display Camera	<i>Some:</i> 15.4" (391mm) WSXGA+ (1680x1050) color , anti-glare, 200 nits, 16:10, 500:1 <i>Some:</i> 15.4" (391mm) WUXGA (1920x1200) color , anti-glare, 175 nits, 16:10, 500:1 None											
Graphics	NVIDIA® Quadro® FX 570M , PCI Express® x16, 256MB memory, TurboCache, DVI pass-through support to optional Advanced Mini Dock or Advanced Dock											
Keyboard TrackPoint® Touch pad ThinkLight™	89-key, ThinkVantage button, spill-resistant, multimedia Fn keys, Windows/Appl keys TrackPoint® pointing device, "Press-to-Select," Internet Scroll Bar ¹³ , magnifying glass UltraNav™ multi-pointing system, touch pad below keyboard, Tap Zones Illuminates the keyboard to improve visibility in low-light conditions											
Dimensions ³ Weight ² Case material Battery - type Battery - life ¹⁰	<i>15.4" models (WxDxH):</i> 14.1" x 10.0" x 1.2–1.4"; 358.4mm x 255mm x 29.8–34.5mm with optical drive and battery; starting at 5.9 lb (2.7kg) <i>Top:</i> Super-Elastic PolyCarbonate (SEPC); <i>Bottom:</i> Carbon-Fiber Reinforced Plastic Lithium Ion 9-cell / supports unique 2nd battery in Ultrabay Slim <i>9-cell:</i> up to 5.9 hr; <i>9-cell plus Ultrabay battery:</i> up to 7.9 hr											
Chipset	Mobile Intel PM965 Express Chipset (Memory Controller Hub); ICH8M-Enhanced I/O Controller Hub (SATA 3.0Gb/s, ATA-100 EIDE, PCI Express x1, PCI bus, USB, LPC bus, [Bluetooth], [fingerprint]) / PCI bus (Ricoh® R5C847 Cardbus/1394/Multicard) / LPC bus (WPCN385 Super I/O, Atmel® 97SC3203 TPM)											
PC Card ExpressCard/54 Smart Card Read Multicard Reader Ports	One slot (Type I, Type II), CardBus 32-bit One slot (ExpressCard/34, ExpressCard/54) None 4-in-1 reader (MultiMediaCard, Memory Stick® PRO™, Secure Digital, xD-Picture Card™) Three USB 2.0, DB-15 (external VGA monitor), RJ-11 (modem), RJ-45 (ethernet), IEEE 1394 FireWire 400 (4-pin connector; 1394a-2000 standard)											
Wireless antenna Mini PCI Express Intel 11n ²⁸	UltraConnect™ II antenna / on-off switch for all wireless radios Three Mini PCI Express slots / only 802.11 wireless is customer upgradable 11a/b/g/n wireless ⁴ , Mini PCIe adapter, Intel Wireless WiFi Link 4965AGN, MIMO 2x3 (Kedron)										Supports ThinkVantage® technologies	
WWAN 1G Turbo UWB	None <i>Some:</i> Intel Turbo Memory, Mini PCIe adapter, 1GB flash, disk-cache accelerator None (uses Half-Mini PCI Express slot)										90-watt (NVIDIA) AC adapter ThinkPad Roll Cage and Top Cover Roll Cage (one-piece magnesium) ENERGY STAR® 4.0-compliant RoHS-compliant	
Modem Bluetooth™ Ethernet Intel AMT Audio support	56K V.92 ⁶ modem in Communications Daughter Card socket Bluetooth 2.0 wireless, USB 2.0 interface via ICH8M, LED indicator Gigabit ethernet, Intel 82566MM Nineveh (PHY), PCIe x1 (GLCI), PXE Intel Active Management Technology (IAMT) High Definition (HD) Audio, AD1984JCP codec / stereo speakers, 1 watt / volume up, down, mute buttons / internal microphone, microphone input jack, headphone jack										International Warranty Service ¹⁷ 24 hour x 7 day ¹⁸ toll-free support during the warranty period ¹² via 800-426-7378	
Security Security chip Fingerprint reader	Power-on password, hard disk password, supervisor password, security keyhole Trusted Platform Module , Atmel chip, TCG 1.2-compliant Fingerprint reader on palm rest , swipe sensor, supports the security chip										ThinkPlus™.22 2-year LOR ²⁴ 9x5 NBD 41C9175	
Limited warranty ¹² 3-years/1-yr battery - EasyServ™.19 depot repair service / service upgrades ²² available												
1GB PC2-5300 DDR2 SODIMM (TopSeller)	43R1999	T/R/W/SL Series Li-Ion Battery 6-cell	40Y6799	2GB PC2-5300 DDR2 SODIMM (TopSeller)	43R2000	T/R/W/SL Series Li-Ion Battery 9-cell	40Y6797	Serial Hard Drive Ultrabay Slim Adapter (flat)	40Y8725	Advanced Ultrabay Battery II 3-cell	43R9250	ThinkPlus 3-year LOR 9x5 NBD
128GB SSD SATA 3.0Gb/s 1.8" (2.5" cover)	43N3406	ThinkPad 90W AC Adapter	40Y7659	200GB Disk FDE SATA 1.5Gb/s (7200 rpm)	41N5738	90W Slim AC/DC Combo Adapter	41N8460	ThinkPad 90W AC Adapter	40Y7659	ThinkPad Deluxe Expander Case	43R2478	ThinkPlus 4-year LOR 9x5 NBD
USB 2.0 Ultra Secure Memory Key 8GB	45J5918	ThinkPad Executive Leather Case	43R2480	USB 2.0 Lenovo Enhanced Port Replicator	43R8770	ThinkPad Executive Leather Case	43R2480	ThinkPad 90W AC Adapter	40Y7659	ThinkPad Executive Leather Case	43R2480	ThinkPlus 5-year LOR 9x5 NBD
ThinkPad Essential Port Replicator	250510W	ThinkVision® L1940p Wide 19" Monitor	4424HB6	ThinkPad Advanced Mini Dock	250410U	ThinkVision L2240p Wide 22" Monitor	4422HB6	ThinkPad 90W AC Adapter	40Y7659	ThinkPad Executive Leather Case	43R2480	ThinkPlus 4-year P&L P/U Depot
ThinkPad Advanced Dock	250310U	ThinkVision L2440x Wide 24" Monitor	4421HB2	Other accessories on O-T61 sheet		ThinkVision L2440x Wide 24" Monitor	4421HB2	Other accessories on O-T61 sheet		Other accessories on O-T61 sheet		ThinkPlus 5-year P&L P/U Depot
		Other accessories at lenovo.com/accessories										41C9178
												41C9179
												41C9177
												41C9172
												41C9178
												41C9180
												Post-warranty annual maintenance agreements at lenovo.com/thinkplus/warranty

See footnotes for important warranty information

* Intel Centrino® with vPro™ technology

ES: US model announced January 8, 2008; previous models on July 10 or October 30, 2007

© Lenovo (CR3-10) January 2008

ThinkPad® T61p 15W 6457 (NVIDIA) - Education (EasyServ)

Personal Systems Reference (PSREF)

Type-model	Proc- essor	GHz	Memory	Wide- screen display	Graphics controller memory	Disk SATA GB ³ rpm	EIDE optical	Mini PCIe 802.11 wireless	Mini PCIe WWAN or Turbo	Mini PCIe UWB wireless	Card slot	Blue- tooth	Finger print reader	Bat- tery cells	Vista preload	Avail date
6457-06U	T9300	2.50	2GB	15.4" WSXGA+	256MB	250G 5400	DVD±RW	11a/b/g ³²	None	UWB	/54	Blue	Fing	9	Business32	Apr 08
<i>Italic MTM: not a base model for building a custom model</i>																
<p>• This model has an EasyServ™.19 depot repair service 3-year limited warranty Educational models are available only to public or private K-12 or higher accredited schools organized and operated exclusively for educational purposes for use by qualified students and teachers.</p>																
Positioning Processor	<p><i>Premiere performance; two spindles</i> Intel® Core™ 2 Duo processor T9300 with dual-core, Intel 64 Technology, Enhanced Intel SpeedStep® technology¹, Intel Dynamic Acceleration, Execute Disable Bit, Virtualization Technology, 800MHz system bus, and 6MB shared L2 cache</p>											<p>Preloaded operating system²⁰ - Microsoft® Windows® Vista® Business Edition (32-bit) ♦ Vista Premium logo</p>				
Memory	<p>2GB std / 4GB max⁷ / PC2-5300 667MHz DDR2, non-parity, dual-channel capable, two 200-pin SO-DIMM sockets; <i>Non-italics:</i> standard memory in 1 socket; 1 socket available</p>											<p>Preloaded applications¹⁴ • Microsoft Office OneNote® 2007 (and CD) • Education software - VitalSource Library College Edition - Adobe® Instructor Resource Cntr - Adobe Digital School Collection - Photoshop Elements (and CD) - Premier Elements (and DVD) - Acrobat 8 Professional - Contribute 4 • Rescue and Recovery™ • Access Connections™ • Client Security Solution™ • ThinkVantage Productivity Center • ThinkVantage System Update • System Migration Assistant • Norton Internet Security™ (90 days of virus definitions) • Diskeeper® Home • PC-Doctor™ (diagnostics) • ThinkPad Utilities (Power Manager and Presentation Director) • Adobe® Reader • Windows Live™ Toolbar • Windows Live Search • Picasa from Google • Fingerprint Software • Microsoft Office 2007 Trial (60-day) • Sonic RecordNow and Drive Letter Access (DVD±RW) • Corel® WinDVD® (DVD±RW)</p>				
Diskette drive EIDE DVD±RW Ultrabay Slim Serial ATA disk	<p>None (use optional USB-based diskette drive) DVD burner, Ultrabay Slim Burner (41N5643), dual-layer, removable from Ultrabay Slim One modular bay for interchangeable devices (right side), 9.5mm high bay, flat bezel 250GB⁸ (5400 rpm) / SATA 1.5Gb/s, 9.5mm high, removable, upgradable, 9.5mm high bay, supports 2nd disk, ThinkPad Shock Mounted Hard Drive, Active Protection System™</p>															
Widescreen display Camera	<p>15.4" (391mm) WSXGA+ (1680x1050) color, anti-glare, 200 nits, 16:10 aspect ratio, 500:1 contrast ratio None</p>															
Graphics	<p>NVIDIA® Quadro® FX 570M, PCI Express® x16, 256MB memory, TurboCache, DVI pass-through support to optional Advanced Mini Dock or Advanced Dock</p>															
Keyboard TrackPoint® Touch pad ThinkLight™	<p>89-key, ThinkVantage button, spill-resistant, multimedia Fn keys, Windows/Appl keys TrackPoint® pointing device, "Press-to-Select," Internet Scroll Bar¹³, magnifying glass UltraNav™ multi-pointing system, touch pad below keyboard, Tap Zones Illuminates the keyboard to improve visibility in low-light conditions</p>															
Dimensions ³ Weight ² Case material Battery - type Battery - life ¹⁰	<p><i>15.4" models (WxDxH):</i> 14.1" x 10.0" x 1.2–1.4"; 358.4mm x 255mm x 29.8–34.5mm with optical drive and battery: starting at 5.9 lb (2.7kg) <i>Top:</i> Super-Elastic PolyCarbonate (SEPC); <i>Bottom:</i> Carbon-Fiber Reinforced Plastic Lithium Ion 9-cell / supports unique 2nd battery in Ultrabay Slim 9-cell: up to 5.9 hr; 9-cell plus Ultrabay battery: up to 7.9 hr</p>															
Chipset	<p>Mobile Intel PM965 Express Chipset (Memory Controller Hub); ICH8M-Enhanced I/O Controller Hub (SATA 3.0Gb/s, ATA-100 EIDE, PCI Express x1, PCI bus, USB, LPC bus, [Bluetooth], [fingerprint]) / PCI bus (Ricoh® R5C847 Cardbus/1394/Multicard) / LPC bus (WPCN385 Super I/O, Atmel® 97SC3203 TPM)</p>															
PC Card ExpressCard/54 Smart Card Read Multicard Reader Ports	<p>One slot (Type I, Type II), CardBus 32-bit One slot (ExpressCard/34, ExpressCard/54) None 4-in-1 reader (MultiMediaCard, Memory Stick® PRO™, Secure Digital, xD-Picture Card™) Three USB 2.0, DB-15 (external VGA monitor), RJ-11 (modem), RJ-45 (ethernet), IEEE 1394 FireWire 400 (4-pin connector; 1394a-2000 standard)</p>															
Wireless antenna Mini PCI Express 11a/b/g ³² WWAN Turbo Memory UWB Modem Bluetooth™ Ethernet Intel AMT Audio support	<p>UltraConnect™ II antenna / on-off switch for all wireless radios Three Mini PCI Express slots / only 802.11 wireless is customer upgradable 11a/b/g wireless⁴, ThinkPad 11a/b/g Mini PCIe Adapter, Atheros AR5006EX None None Wireless USB based on Ultra-Wideband (UWB), Half-Mini PCIe adapter 56K V.92⁶ modem in Communications Daughter Card socket Bluetooth 2.0 wireless, USB 2.0 interface via ICH8M, LED indicator Gigabit ethernet, Intel 82566MM Nineveh (PHY), PCIe x1 (GLCI), PXE Intel Active Management Technology (IAMT) High Definition (HD) Audio, AD1984JCP codec / stereo speakers, 1 watt / volume up, down, mute buttons / internal microphone, microphone input jack, headphone jack</p>															
Security Security chip Fingerprint reader	<p>Power-on password, hard disk password, supervisor password, security keyhole Trusted Platform Module, Atmel chip, TCG 1.2-compliant Fingerprint reader on palm rest, swipe sensor, supports the security chip</p>											<p>Supports ThinkVantage® technologies</p>				
Limited warranty ¹²	<p>3-years/1-yr battery - EasyServ™.19 depot repair service / service upgrades²² available</p>											<p>90-watt (NVIDIA) AC adapter ThinkPad Roll Cage and Top Cover Roll Cage (one-piece magnesium) ENERGY STAR® 4.0-compliant RoHS-compliant International Warranty Service¹⁷ 24 hour x 7 day¹⁸ toll-free support during the warranty period¹² via 800-426-7378</p>				
1GB PC2-5300 DDR2 SODIMM 2GB PC2-5300 DDR2 SODIMM ThinkPad DVD Ultrabay Slim Burner (flat) Serial Hard Drive Ultrabay Slim Adapter (flat) 128GB SSD SATA 3.0Gb/s 1.8" (2.5" cover) 200GB Disk FDE SATA 1.5Gb/s (7200 rpm) 250GB Disk 9.5mm SATA 1.5Gb/s (5400 rpm) 320GB Disk SATA 1.5Gb/s (5400 rpm) USB 2.0 Security Memory Key 4GB USB 2.0 Super Multi-Burner Drive ThinkPad Convertible Monitor Stand ThinkPad Advanced Mini Dock ThinkPad Advanced Dock Other accessories on O-T61 sheet	40Y7734 40Y7735 41N5643 40Y8725 43N3406 41N5738 43R8152 43N3403 41U5120 41N5565 40Y7620 250410U 250310U	T/R/W/SL Series Li-Ion Battery 6-cell T/R/W/SL Series Li-Ion Battery 9-cell Advanced Ultrabay Battery II 3-cell ThinkPad External Battery Charger ThinkPad 90W AC Adapter 90W Slim AC/DC Combo Adapter ThinkPad Business Topload Case ThinkPad Business Backpack ThinkPad Deluxe Expander Case ThinkVision® L1700p 17" Monitor ThinkVision L1940p Wide 19" Monitor ThinkVision L2240p Wide 22" Monitor ThinkVision L2440x Wide 24" Monitor	40Y6799 40Y6797 43R9250 40Y7625 40Y7659 41N8460 43R2476 43R2482 43R2478 9417HE2 4424HB6 4422HB6 4421HB2	40Y6799 40Y6797 43R9250 40Y7625 40Y7659 41N8460 43R2476 43R2482 43R2478 9417HE2 4424HB6 4422HB6 4421HB2	40Y6799 40Y6797 43R9250 40Y7625 40Y7659 41N8460 43R2476 43R2482 43R2478 9417HE2 4424HB6 4422HB6 4421HB2	40Y6799 40Y6797 43R9250 40Y7625 40Y7659 41N8460 43R2476 43R2482 43R2478 9417HE2 4424HB6 4422HB6 4421HB2	40Y6799 40Y6797 43R9250 40Y7625 40Y7659 41N8460 43R2476 43R2482 43R2478 9417HE2 4424HB6 4422HB6 4421HB2	40Y6799 40Y6797 43R9250 40Y7625 40Y7659 41N8460 43R2476 43R2482 43R2478 9417HE2 4424HB6 4422HB6 4421HB2	40Y6799 40Y6797 43R9250 40Y7625 40Y7659 41N8460 43R2476 43R2482 43R2478 9417HE2 4424HB6 4422HB6 4421HB2	40Y6799 40Y6797 43R9250 40Y7625 40Y7659 41N8460 43R2476 43R2482 43R2478 9417HE2 4424HB6 4422HB6 4421HB2	40Y6799 40Y6797 43R9250 40Y7625 40Y7659 41N8460 43R2476 43R2482 43R2478 9417HE2 4424HB6 4422HB6 4421HB2	40Y6799 40Y6797 43R9250 40Y7625 40Y7659 41N8460 43R2476 43R2482 43R2478 9417HE2 4424HB6 4422HB6 4421HB2	40Y6799 40Y6797 43R9250 40Y7625 40Y7659 41N8460 43R2476 43R2482 43R2478 9417HE2 4424HB6 4422HB6 4421HB2	40Y6799 40Y6797 43R9250 40Y7625 40Y7659 41N8460 43R2476 43R2482 43R2478 9417HE2 4424HB6 4422HB6 4421HB2	40Y6799 40Y6797 43R9250 40Y7625 40Y7659 41N8460 43R2476 43R2482 43R2478 9417HE2 4424HB6 4422HB6 4421HB2	40Y6799 40Y6797 43R9250 40Y7625 40Y7659 41N8460 43R2476 43R2482 43R2478 9417HE2 4424HB6 4422HB6 4421HB2
<p>Other accessories on O-T61 sheet</p>																

See footnotes for important warranty information
 US model announced on April 10, 2008

© Lenovo
 (CR4-4) April 2008

Partial list of accessories supported on:

- ThinkPad T61 originally announced on May 31, 2007
- ThinkPad T61 14W originally announced on May 9, 2007
- ThinkPad T61 15W originally announced on May 31, 2007

Memory

512MB PC2-5300 DDR2 SODIMM	40Y7733	ann 01/05/06
1GB PC2-5300 DDR2 SODIMM (TopSeller)	43R1999	ann 03/25/08
1GB PC2-5300 DDR2 SODIMM	40Y7734	ann 01/05/06
2GB PC2-5300 DDR2 SODIMM (TopSeller)	43R2000	ann 03/25/08
2GB PC2-5300 DDR2 SODIMM	40Y7735	ann 11/28/06

Ultrabay Slim 9.5mm (best to use flat bezel options)

Serial/Parallel Port Bay Adapter (flat bezel)	40Y8121	ann 01/31/06
Serial Hard Drive Ultrabay Slim Adapter (flat)	40Y8725	ann 09/20/05
ThinkPad DVD Ultrabay Slim Burner (flat)	41N5643	ann 05/31/07

Storage and removable storage

160GB Disk SATA 1.5Gb/s (5400 rpm) ⁴¹	41N5692	ann 03/20/07
160GB Disk SATA 1.5Gb/s (7200 rpm) ⁴¹	41N5737	ann 10/16/07
200GB Disk FDE SATA 1.5Gb/s (7200 rpm) ⁴¹	41N5738	ann 10/16/07
250GB Disk SATA 1.5Gb/s (5400 rpm) ⁴¹	43R8152	ann 01/15/08
320GB Disk SATA 1.5Gb/s (5400 rpm) ⁴¹	43N3403	ann 08/05/08

⁴¹ Can be used as the main HDD or with ThinkPad

Serial ATA Hard Drive Ultrabay Slim Adapter 40Y8725

in the Ultrabay or in the ThinkPad Advanced Dock 250310U.

Only 14W (14.1" widescreen) and 15W (15.4" widescreen) models:

128GB SSD SATA 3.0Gb/s 1.8" (2.5" cover)	43N3406	ann 08/26/08
USB 2.0 Essential Memory Key 8GB	45J7905	ann 07/15/08
USB 2.0 Essential Memory Key 32GB	45K1258	ann 10/28/08
USB 2.0 Security Memory Key 2GB	41U5119	ann 07/17/07
USB 2.0 Security Memory Key 4GB	41U5120	ann 07/17/07
USB 2.0 Ultra Secure Memory Key 2GB	45J5916	ann 08/26/08
USB 2.0 Ultra Secure Memory Key 4GB	45J5917	ann 08/26/08
USB 2.0 Ultra Secure Memory Key 8GB	45J5918	ann 08/26/08
USB Portable Diskette Drive	05K9276	ann 06/05/00
USB 2.0 CD-RW/DVD-ROM Combo II Drive	40Y8637	ann 01/05/06
USB 2.0 Portable 160GB Hard Disk	43R1784	ann 09/23/08
USB 2.0 Portable Secure 160GB Hard Disk	43R2018	ann 11/18/08
USB 2.0 Portable Secure 320GB Hard Disk	43R2019	ann 11/18/08
USB 2.0 Super Multi-Burner Drive	41N5565	ann 01/23/07

Wireless WAN (Mini PCI Express)**Only 14W 7663-3SU, 15W 6457-98U, and 8895-6WU models:**

Verizon WWAN EV-DO Rev. A Mini PCIe	43R1818	ann 03/04/08
-------------------------------------	---------	--------------

ThinkPad Expansion

USB 2.0 Lenovo Enhanced Port Replicator	43R8770	ann 02/26/08
ThinkPad Adjustable Notebook Stand	40Y7676	ann 09/20/05
ThinkPad Essential Port Replicator	250510W	ann 09/20/05
ThinkPad Advanced Mini Dock	250410U	ann 09/20/05
ThinkPad Advanced Dock	250310U	ann 09/20/05

Keyboard

TrackPoint Cap Collection	73P2698	ann 12/16/03
USB Numeric Keypad	33L3225	ann 05/01/00
Preferred Pro USB Keyboard	73P5220	ann 06/21/05
Enhanced Performance USB Keyboard	73P2620	ann 03/23/04
Wireless Kybd & Opt Wheel Mouse (via USB)	73P4067	ann 12/07/04
USB Keyboard with UltraNav	31P8950	ann 01/28/03
USB Travel Keyboard with UltraNav	31P9490	ann 04/27/04
Lenovo USB Fingerprint Keyboard	73P4730	ann 02/22/05

Mouse

Optical Wheel Mouse (USB)	06P4069	ann 05/21/03
Optical ScrollPoint® Mouse (USB, PS/2)	31P7405	ann 08/27/02
Optical Wheel Travel Mouse (USB, PS/2)	31P7410	ann 06/04/02
Laser Tilt Wheel Mouse (USB, PS/2)	41U3074	ann 01/23/07
Lenovo Wireless Laser Mouse (blk, via USB)	45K1696	ann 11/25/08
Lenovo Wireless Laser Mouse (red, via USB)	51J0198	ann 11/25/08
Laser Tilt Wheel Travel Mouse (Bluetooth)	41U5008	ann 01/22/08

Security

Kensington® Cable Lock from Lenovo	73P2582	ann 12/29/03
Kensington Twin Head Cable Lock	45K1620	ann 09/30/08
USB Gemplus GemPC Smart Card Reader	41N3040	ann 02/21/06
PC Card Gemplus Smart Card Reader	41N3004	ann 12/13/05
ExpressCard Gemplus Smart Card Reader	41N3043	ann 06/27/06

Multimedia

USB 2.0 Lenovo Multimedia Headset	40Y8518	ann 06/27/06
USB 2.0 Lenovo Webcam	40Y8519	ann 08/29/06

Batteries**Only 14W models (14.1" widescreen):**

T/R 14W Standard Battery 4-cell	41U3196	ann 05/09/07
T/R 14W Enhanced Battery 6-cell	41U3198	ann 05/09/07
T/R 14W High Capacity Battery 9-cell	43R2499	ann 03/04/08

Only 14 standard (14.1") and 15W models (15.4" widescreen):

T/R/W/SL Series Li-Ion Battery 6-cell	40Y6799	ann 01/05/06
T/R/W/SL Series Li-Ion Battery 9-cell	40Y6797	ann 09/20/05

All models:

Advanced Ultrabay Battery II 3-cell ⁴³	43R9250	ann 04/22/08
---	---------	--------------

⁴³ Used in Ultrabay Slim bay.

ThinkPad External Battery Charger ⁴⁴	40Y7625	ann 09/20/05
---	---------	--------------

⁴⁴ Requires the ThinkPad 90W AC Adapter

40Y7659 (adapter provided with some systems).

ThinkPad 65W AC Adapter ⁴⁵	40Y7696	
---------------------------------------	---------	--

⁴⁵ Only compatible with the 945GM and GM965 chipset models.

ThinkPad 90W AC Adapter	40Y7659	ann 09/20/05
-------------------------	---------	--------------

ThinkPad 90W Slim AC/DC Combo Adapter	41N8460	ann 11/27/07
---------------------------------------	---------	--------------

Carrying Cases**Up to 14.1" widescreen models:**

ThinkPad Expander Case	43R9118	ann 06/24/08
ThinkPad Women's Microfiber Tote	22P8855	
ThinkPad Women's Leather Trim Tote	22P8856	
ThinkPad Convertible Carrying Case	22P8860	
ThinkPad Women's Executive Leather Tote	22P8857	
Women's Executive Red Leather Tote	22P8858	

Up to 15.4" widescreen models:

Lenovo Carrying Case - Messenger Max	41U5253	ann 05/01/07
Lenovo Carr Case - Performance Backpack	41U5254	ann 05/01/07
Lenovo Standard Case	45K1697	ann 11/25/08
Lenovo Standard Backpack	45K1698	ann 11/25/08
ThinkPad Business Topload Case	43R2476	ann 05/13/08
ThinkPad Business Backpack	43R2482	ann 05/13/08
ThinkPad Deluxe Expander Case	43R2478	ann 05/13/08
ThinkPad Executive Leather Case	43R2480	ann 05/13/08

Up to 17.0" widescreen models:

ThinkPad 17W Business Topload Case	43R9117	ann 08/12/08
------------------------------------	---------	--------------

Monitors

ThinkVision® L174 17" Monitor	9227AE1	ann 04/15/08
ThinkVision L1700p 17" Monitor	9417HE2	ann 09/17/08
ThinkVision L1900p 19" Monitor	4431HE1	ann 11/11/08
ThinkVision L1940p Wide 19" Monitor	4424HB6	ann 09/17/08
ThinkVision L200p Wide 20.1" Monitor	4438HB6	ann 04/15/08
ThinkVision L2240p Wide 22" Monitor	4422HB6	ann 09/17/08
ThinkVision L2440p Wide 24" Monitor	4420HB2	ann 09/17/08
ThinkVision L2440x Wide 24" Monitor	4421HB2	ann 09/17/08

Monitor Accessories⁴⁶

ThinkVision USB Soundbar	40Y7616	ann 08/23/05
ThinkVision Soundbar	45K1263	ann 09/16/08
Kensington Cable Lock from Lenovo	73P2582	ann 12/29/03
ThinkPad Convertible Monitor Stand	40Y7620	ann 01/05/06
Radial Arm	19K4464	ann 05/05/00

⁴⁶ Compatible on selected Lenovo and ThinkVision monitors.More information at www.lenovo.com/support/monitoraccessoriesOther accessories at www.lenovo.com/accessoriesAccessories Guide pdf at www.lenovo.com/accessoriesguide

ThinkPad®



Lenovo ThinkPad T400



Lenovo ThinkPad T400



USB 2.0 Portable Secure Hard Disk
160GB 43R2018
320GB 43R2019



Lenovo ThinkPad T400



Lenovo ThinkPad T400



Lenovo ThinkPad T400

ThinkPad® T400 6473 (GMA) - TopSeller

Personal Systems Reference (PSREF)

Type-model	Proc- essor	GHz	Memory	Wide- screen display	Cam- era	Integrated graphics	Disk SATA GB ³ rpm	SATA optical	Mini PCIe 802.11 wireless	Mini PCIe WWAN	Mini PCIe Finger or Turbo reader	Blue- tooth	Preload	Avail date
6473-P1U	P8400	2.26	2GB	14.1" WXGA	None	GMA	160G 5400	DVD±RW	Intel 5100	WWAN upg	None	Finger	None	XP Pro Sep 08

• **This small and medium business (SMB) model is part of the US TopSeller™ Program**

Positioning Processor	<i>Premiere performance; two spindles</i> Intel® Core™ 2 Duo processor P8400 with dual-core, Intel HD Boost, 1066MHz system bus; and 3MB L2 cache										Preloaded operating system²⁰ - Microsoft® Windows® XP Professional with Vista® COA ↳ Vista Premium logo							
Memory	2GB std / 8GB max ⁷ / PC3-8500 1066MHz DDR3 , non-parity, dual-channel capable, two 204-pin SO-DIMM sockets; <i>Non-italics:</i> standard memory in one socket; one socket available										Preloaded applications¹⁴ • Rescue and Recovery™ • Access Connections™ • Client Security Solution™ • ThinkVantage Productivity Center • ThinkVantage System Update • McAfee VirusScan® Plus with SiteAdvisor™ (30 days of virus definitions) • PC-Doctor™ (diagnostics) • ThinkPad Utilities (Power Manager and Presentation Director) • Adobe® Reader • Windows Live™ Toolbar • Windows Live Search • Fingerprint Software (fingerprint models) • Microsoft Office 2007 Trial (60-day) • Roxio® Creator® Business Edition • Roxio MyDVD® (DVD±RW)							
SATA DVD±RW Ultrabay Slim SATA disk	DVD burner, SATA 1.5Gb/s, 9.5mm Ultrabay slim, removable (43N3214) One modular bay for interchangeable devices (right side), 9.5mm high bay, flat bezel 160GB⁸ (5400 rpm) / SATA 1.5Gb/s, 2.5" wide, 9.5mm high, removable, upgradable, supports 2nd disk, ThinkPad Shock Mounted Hard Drive, Active Protection System™																	
Widescreen display Camera	14.1" (358.1mm) WXGA (1280x800) color , anti-glare, CCFL backlight, 185 nits, 16:10 aspect ratio, 300:1 contrast ratio None																	
Integrated graphics	Intel Graphics Media Accelerator 4500MHD (GMA 4500MHD) , in GM45, DVI pass-through support to optional Advanced Mini Dock or Advanced Dock; <i>Maximum external resolution: 2048x1536@75Hz</i>																	
Keyboard TrackPoint® Touch pad ThinkLight™	89-key, ThinkVantage button, spill-resistant, multimedia Fn keys TrackPoint® pointing device, "Press-to-Select," Internet Scroll Bar ¹³ , magnifying glass UltraNav™, wide touch pad below keyboard, Tap Zones, scrolling regions label Illuminates the keyboard to improve visibility in low-light conditions																	
Dimensions ³ Weight ² Case material Battery - type Battery - life ¹⁰	<i>6-cell 14.1W" (WxDxH):</i> 13.2" x 9.4" x 1.1–1.3"; 335.5 x 238mm x 28–32mm <i>6-cell:</i> starting at 5.0 lb (2.3kg) <i>Top:</i> Super-Elastic PolyCarbonate (SEPC); <i>Bottom:</i> Carbon-Fiber Reinforced Plastic Lithium Ion 6-cell , supports unique 2nd battery in Ultrabay Slim <i>6-cell:</i> up to 6.5 hr; <i>6-cell plus Ultrabay battery:</i> up to 8.0 hr; <i>9-cell:</i> up to 9.8 hr																	
Chipset	Mobile Intel GM45 Express Chipset (Graphics Memory Controller Hub), ICH9M-Enhanced I/O Controller Hub (SATA 3.0Gb/s, USB 2.0, PCI Express® 1.1, PCI 2.3, security chip, ethernet MAC), LPC bus (WPCN385 Super I/O)																	
ExpressCard/54 PC Card Smart Card Read Multicard Reader Ports	One slot (ExpressCard/34, ExpressCard/54) One slot (Type I, Type II), CardBus 32-bit None None Three USB 2.0, external monitor (VGA DB-15), modem (RJ-11), ethernet (RJ-45), IEEE 1394 FireWire 400 (4-pin connector; 1394a-2000 standard)																	
Mini PCI Express Intel 5100 ²⁸ WWAN upg 2G Turbo UWB Modem Bluetooth™ Ethernet Intel AMT Audio support Security Security chip Fingerprint reader	Three Mini PCI Express slots 11a/b/g/n wireless ⁴ , Mini PCIe adapter, Intel WiFi Link 5100, 1x2 (Shirley Peak) Wireless WAN upgradable, requires Verizon® (43R9151) or AT&T® (43R9152) None None 56K V.92 ⁶ modem None Intel 82567LM Gigabit Network Connection (Boazman), PHY, PCIe x1 None High Definition (HD) Audio, AD1984HD codec / stereo speakers, 1 watt / volume up, down, mute buttons / digital microphone, microphone input jack, headphone jack Power-on password, hard disk password, supervisor password, security keyhole Trusted Platform Module, integrated in ICH9M, TCG 1.2-compliant Fingerprint reader on palm rest, swipe sensor, supports the security chip										Supports ThinkVantage® technologies							
Limited warranty ¹²	3-years/1-yr battery - EasyServ™.19 depot repair service / service upgrades ²² available										65-watt (GMA graphics) AC adapter ThinkPad Roll Cage and Top Cover Roll Cage (one-piece magnesium) Climate Savers® certified EPEAT™ Silver rating ENERGY STAR® 4.0-compliant RoHS-compliant International Warranty Service ¹⁷ 24 hour x 7 day ¹⁸ toll-free support during the warranty period ¹² via 800-426-7378							
1GB PC3-8500 DDR3 SODIMM (TopSeller)	43R2045	T/R 14W Standard Battery 4-cell	41U3196	ThinkPlus™.22 2-year LOR 9x5 NBD	41C9175	1GB PC3-8500 DDR3 SODIMM (TopSeller)	43R2046	T/R 14W Enhanced Battery 6-cell	41U3198	ThinkPlus 3-year LOR 9x5 NBD	41C9176	Blu-ray Burner Ultrabay Slim SATA 1.5Gb/s	43N3215	T/R 14W High Capacity Battery 9-cell	43R2499	ThinkPlus 4-year LOR 9x5 NBD	41C9177	
Serial ATA Hard Drive Bay Adapter II SATA	43R1980	Advanced Ultrabay Battery II 3-cell	43R9250	ThinkPlus 5-year LOR 9x5 NBD	41C9179	128GB SSD SATA 3.0Gb/s 1.8" (2.5" cover)	43N3406	90W Slim AC/DC Combo Adapter	41N8460	ThinkPlus 4-year P&L P/U Depot	41C9178	320GB Disk SATA 1.5Gb/s (5400 rpm)	43N3403	ThinkPad Business Topload Case	43R2476	ThinkPlus 5-year P&L P/U Depot	41C9180	
USB 2.0 Super Multi-Burner Drive	41N5565	ThinkPad Business Backpack	43R2482	Post-warranty annual maintenance agreements at	lenovo.com/thinkplus/warranty	ThinkPad Adjustable Notebook Stand	40Y7676	ThinkPad Privacy Filter	43R2472			ThinkPad Advanced Dock	250310U	ThinkVision® L1940p Wide 19" Monitor	4424HB6			
Verizon WWAN UNDP Broadband	43R9151	ThinkVision L2240p Wide 22" Monitor	4422HB6			AT&T WWAN HSPA Broadband Mini PCIe	43R9152	ThinkVision L2440p Wide 24" Monitor	4420HB2			Other accessories on O-T400 sheet		Other accessories at lenovo.com/accessories				

See footnotes for important warranty information
US model announced September 2, 2008

↳ Intel Centrino® 2 processor technology

© Lenovo
(ML3-9) September 2008

Type-model	Proc- essor	GHz	Memory	Wide- screen display	Cam- era	Integrated graphics	Disk SATA GB ³	SATA rpm	SATA optical	Mini PCIe 802.11 wireless	Mini PCIe WWAN	Mini PCIe UWB or Turbo	Finger print reader	Blue- tooth	Intel AMT	Preload	Avail date
7417-T1U	P8400	2.26	2GB 14.1" WXGA			GMA 160G	5400	DVD±RW	⇄	Intel 5100 ²⁸	AT&T ²³		Fing			Bus 32	Aug 08
7417-T2U	P8400	2.26	2GB 14.1" WXGA			GMA 160G	7200	DVD±RW	⇄	Intel 5100	AT&T		Fing	Blue		Bus 32	Aug 08
7417-TNU	T9400	2.53	2GB 14.1" WXGA	Cam		GMA 160G	7200	DVD±RW	⇄	Intel 5100	AT&T	2G Turbo	Fing	Blue		XP Pro	Aug 08
7417-TPU	P8400	2.26	2GB 14.1" WXGA			GMA 160G	5400	DVD±RW	⇄	Intel 5100	WWAN upg		Fing			XP Pro	Aug 08
7417-TRU	P8400	2.26	2GB 14.1" WXGA			GMA 160G	7200	DVD±RW	⇄	Intel 5100	WWAN upg		Fing	Blue		XP Pro	Aug 08
7417-TSU	T9400	2.53	2GB 14.1" WXGA	Cam		GMA 160G	7200	DVD±RW	⇄	Intel 5100	WWAN upg	2G Turbo	Fing	Blue		Bus 32	Aug 08
7417-TTU	P8400	2.26	1GB 14.1" WXGA			GMA 160G	5400	Combo	⇄	Intel 5100	AT&T					Bus 32	Aug 08
7417-TUU	P8400	2.26	1GB 14.1" WXGA			GMA 160G	5400	Combo	⇄	Intel 5100	WWAN upg					XP Pro	Aug 08
7417-P5U	T9400	2.53	2GB 14.1" WXGA	Cam		GMA 160G	7200	DVD±RW	⇄	Intel 5100	WWAN upg		Fing	Blue		XP Pro	Sep 08
7417-11U	P8400	2.26	1GB 14.1" WXGA			GMA 160G	5400	DVD±RW	⇄	Intel 5100	WWAN upg					XP Pro	Oct 08
7417-P9U	P8600	2.40	2GB 14.1" WXGA			GMA 160G	7200	DVD±RW	⇄	Intel 5100	WiMAX		Fing	Blue	AMT	Bus 32	Jan 09
7417-PAU	P8600	2.40	2GB 14.1" WXGA	Cam		GMA 128G	SSD	DVD±RW	⇄	Intel 5100	WWAN upg		Fing	Blue	AMT	XP Pro	Jan 09

• These small and medium business (SMB) models are part of the US TopSeller™ Program

Processor	Intel® Core™ 2 Duo processor P8400, P8600, or T9400 with dual-core, Intel HD Boost, 1066MHz system bus; P8400/P8600: 3MB L2 cache; T9400: 6MB L2 cache	Preloaded operating system²⁰ - Some: Microsoft® Windows® XP Professional with Vista® COA - Some: Microsoft Windows Vista Business Edition (32-bit) ⇄ Vista Premium logo Preloaded applications¹⁴ (all OSes) • Rescue and Recovery™ • Access Connections™ • Client Security Solution™ • ThinkVantage Productivity Center • ThinkVantage System Update • McAfee VirusScan® Plus with SiteAdvisor™ (30 days of virus definitions) • PC-Doctor™ (diagnostics) • ThinkPad Utilities (Power Manager and Presentation Director) • Adobe® Reader • Windows Live™ Toolbar • Windows Live Search • Fingerprint Software (fingerprint models) • Microsoft Office 2007 Trial (60-day) • Roxio® Creator® Business Edition • Roxio MyDVD® (DVD±RW)
Memory	1GB or 2GB std / 8GB max ⁷ / PC3-8500 1066MHz DDR3, non-parity, dual-channel capable, two 204-pin SO-DIMM sockets; <i>Italics:</i> standard memory in both sockets; no sockets available; <i>Non-italics:</i> standard memory in one socket; one socket available	
SATA Combo	<i>Some:</i> CD-RW/DVD-ROM, SATA 1.5Gb/s, 9.5mm Ultrabay Slim, removable (43N3213)	
SATA DVD±RW	<i>Some:</i> DVD burner, SATA 1.5Gb/s, 9.5mm Ultrabay slim, removable (43N3214)	
Ultrabay Slim	One modular bay for interchangeable devices (right side), 9.5mm high bay, flat bezel	
SATA disk	<i>Some:</i> 128GB ⁸ Solid State Drive (SSD) / SATA 3.0Gb/s, 1.8" wide, 8mm high <i>Some:</i> 160GB ⁸ (5400 or 7200 rpm) / SATA 1.5Gb/s, 2.5" wide, 9.5mm high, Active Protection System™ <i>All:</i> removable, upgradable, supports 2nd disk, Shock Mounted Hard Drive	
Widescreen display	14.1" (358.1mm) WXGA (1280x800) color, anti-glare, CCFL backlight, 185 nits, 16:10 aspect ratio, 300:1 contrast ratio	
Camera	<i>Some:</i> camera on top of screen, 1.3-megapixel, fixed focus	
Integrated graphics	Intel Graphics Media Accelerator 4500MHD (GMA 4500MHD), in GM45, DVI pass-through support to optional Advanced Mini Dock or Advanced Dock; <i>Maximum external resolution:</i> 2048x1536 @75Hz (VGA DB-15)	
Keyboard	89-key, ThinkVantage button, spill-resistant, multimedia Fn keys	
TrackPoint®	TrackPoint® pointing device, "Press-to-Select," Internet Scroll Bar ¹³ , magnifying glass	
Touch pad	UltraNav™, wide touch pad below keyboard, Tap Zones, scrolling regions label	
ThinkLight™	Illuminates the keyboard to improve visibility in low-light conditions	
Dimensions ³	6-cell 14.1W" (WxDxH): 13.2" x 9.4" x 1.1-1.3"; 335.5 x 238mm x 28-32mm	
Weight ²	6-cell: starting at 5.0 lb (2.3kg)	
Case color	Black	
Case material	Top: Super-Elastic Polycarbonate (SEPC); Bottom: Carbon-Fiber Reinforced Plastic	
Battery - type	Lithium Ion 6-cell, supports unique 2nd battery in Ultrabay Slim	
Battery - life ¹⁰	6-cell: up to 6.5 hr; 6-cell plus Ultrabay battery: up to 8.0 hr; 9-cell: up to 9.8 hr	
Chipset	Mobile Intel GM45 Express Chipset (Graphics Memory Controller Hub), ICH9M-Enhanced I/O Controller Hub (SATA 3.0Gb/s, USB 2.0, PCI Express® 1.1, PCI 2.3, security chip, ethernet MAC), LPC bus (WPCN385 Super I/O)	Supports ThinkVantage® technologies
ExpressCard/54	One slot (ExpressCard/34, ExpressCard/54)	65-watt (GMA graphics) AC adapter ThinkPad Roll Cage and Top Cover Roll Cage (one-piece magnesium) Climate Savers® certified EPEAT™ Silver rating ENERGY STAR® 4.0-compliant RoHS-compliant International Warranty Service ¹⁷ 24 hour x 7 day ¹⁸ toll-free support during the warranty period ¹² via 800-426-7378 ThinkPlus™.22 1-year LOR 9x5 NBD 41C9166 ThinkPlus 2-year LOR 9x5 NBD 41C9167 ThinkPlus 3-year LOR 9x5 NBD 41C9168 ThinkPlus 4-year LOR 9x5 NBD 41C9171 ThinkPlus 5-year LOR 9x5 NBD 41C9173 ThinkPlus 2-year P&L P/U Depot 41C9169 ThinkPlus 3-year P&L P/U Depot 41C9170 ThinkPlus 4-year P&L P/U Depot 41C9172 ThinkPlus 5-year P&L P/U Depot 41C9174 Post-warranty annual maintenance agreements at lenovo.com/thinkplus/warranty
PC Card	One slot (Type I, Type II), CardBus 32-bit	
Smart Card read	None	
Multicard reader	None	
Ports	Three USB 2.0, external monitor (VGA DB-15), modem (RJ-11), ethernet (RJ-45), IEEE 1394 FireWire 400 (4-pin connector; 1394a-2000 standard)	
Mini PCI Express	Three Mini PCI Express slots	
Intel 5100 ²⁸	<i>Some:</i> 11a/b/g/n wireless ⁴ , Mini PCIe adapter, Intel WiFi Link 5100, 1x2 (Shirley Peak)	
WiMAX	<i>Some:</i> 11a/b/g/n and WiMAX wireless ⁴ , Mini PCIe adap, Intel WiMAX/WiFi Link 5350, 3x3 (450Mbps) WiFi + 1x2 WiMAX (Echo Peak)	
WWAN upg	<i>Some:</i> Wireless WAN upgradable, requires Verizon® (43R9151) or AT&T® (43R9152)	
AT&T ²³	<i>Some:</i> Wireless WAN, Ericsson chipset, Mini PCIe adapter and SIM, GPRS/WCDMA/HSPA, GPS, service contract required with AT&T	
2G Turbo UWB	<i>Some:</i> Intel Turbo Memory, Half-Mini PCIe adapter, 2GB flash, disk-cache accelerator	
Modem	56K V.92 ⁶ modem	
Bluetooth™	<i>Some:</i> Bluetooth 2.0 wireless, LED indicator	
Ethernet	Intel 82567LM Gigabit Network Connection (Boazman), PHY, PCIe x1	
Intel AMT	<i>Some:</i> Intel Active Management Technology (IAMT 4.0)	
Audio support	High Definition (HD) Audio, AD1984HD codec / stereo speakers, 1 watt / volume up, down, mute buttons / digital microphone, microphone input jack, headphone jack	
Security	Power-on password, hard disk password, supervisor password, security keyhole	
Security chip	Trusted Platform Module, integrated in ICH9M, TCG 1.2-compliant	
Fingerprint reader	<i>Some:</i> Fingerprint reader on palm rest, swipe sensor, supports the security chip	
Limited warranty ¹²	1-year - EasyServ™.19 depot repair service / service upgrades ²² available	
2GB PC3-8500 DDR3 SODIMM (TopSeller)	43R2046	T/R 14W High Capacity Battery 9-cell 43R2499
128GB SSD SATA 3.0Gb/s 1.8" (2.5" cover)	43N3406	90W Slim AC/DC Combo Adapter 41N8460
320GB Disk SATA 1.5Gb/s (5400 rpm)	43N3403	ThinkPad Business Topload Case 43R2476
ThinkPad Advanced Dock	250310U	ThinkVision® L2440x Wide 24" Monitor 4421HB2
Other accessories on O-T400 sheet		Other accessories at lenovo.com/accessories

See footnotes for important warranty information

⇄ Intel Centrino® 2 processor technology
 ☞ US models announced January 6, 2009; previous models on August 5, September 2, or October 7, 2008

ThinkPad® T400 2765 (Switchable) - TopSeller

Personal Systems Reference (PSREF)

Type-model	Proc- essor	GHz	Memory	Wide- screen display	CCFL or LED	Cam- era	Switchable graphics	Disk SATA GB ⁸ rpm	SATA optical	Mini PCIe 802.11 wireless	Mini PCIe WWAN	Mini PCIe Bat- UWB tery	Mini PCIe Bat- UWB tery or Turbo cells	Preload	Avail date
⚡ 2765-T1U	P8400	2.26	2GB	14.1" WXGA+			GMA, HD 3470	160G 7200	DVD±RW	⚡ Intel 5100 ²⁸	AT&T ²³	2G Turbo	9 Bus 32	Aug 08	
2765-T2U	T9400	2.53	2GB	14.1" WXGA+		Cam	GMA, HD 3470	160G 7200	DVD±RW	⚡ Intel 5100	AT&T	2G Turbo	9 XP Pro	Aug 08	
2765-T6U	P8400	2.26	2GB	14.1" WXGA+			GMA, HD 3470	160G 7200	DVD±RW	⚡ Intel 5100	WWAN upg	2G Turbo	9 XP Pro	Aug 08	
2765-T7U	T9400	2.53	2GB	14.1" WXGA+		Cam	GMA, HD 3470	160G 7200	DVD±RW	⚡ Intel 5100	WWAN upg	2G Turbo	9 Bus 32	Aug 08	
2765-P3U	T9400	2.53	2GB	14.1" WXGA+		Cam	GMA, HD 3470	160G 7200	DVD±RW	⚡ Intel 5100	WWAN upg		9 XP Pro	Sep 08	
⚡ 2765-33U	P8400	2.26	2GB	14.1" WXGA+	LED		GMA, HD 3470	160G 7200	DVD±RW	⚡ Intel 5100	WWAN upg		9 XP Pro	Oct 08	

• These small and medium business (SMB) models are part of the US TopSeller™ Program

Positioning Processor	<i>Premiere performance; two spindles</i> Intel® Core™ 2 Duo processor P8400 or T9400 with dual-core , Intel HD Boost, 1066MHz system bus; <i>P8400</i> : 3MB L2 cache; <i>T9400</i> : 6MB L2 cache										Preloaded operating system²⁰ - <i>Some</i> : Microsoft® Windows® XP Professional with Vista® COA - <i>Some</i> : Microsoft Windows Vista Business Edition (32-bit) ⚡ Vista Premium logo				
Memory	2GB std / 8GB max ⁷ / PC3-8500 1066MHz DDR3 , non-parity, dual-channel capable, two 204-pin SO-DIMM sockets; <i>Italics</i> : standard memory in both sockets; no sockets available; <i>Non-italics</i> : standard memory in one socket; one socket available										Preloaded applications¹⁴ (all OSes) • Rescue and Recovery™ • Access Connections™ • Client Security Solution™ • ThinkVantage Productivity Center • ThinkVantage System Update • McAfee VirusScan® Plus with SiteAdvisor™ (30 days of virus definitions) • PC-Doctor™ (diagnostics) • ThinkPad Utilities (Power Manager and Presentation Director) • Adobe® Reader • Windows Live™ Toolbar • Windows Live Search • Fingerprint Software (fingerprint models) • Microsoft Office 2007 Trial (60-day) • Roxio® Creator® Business Edition • Roxio MyDVD® (DVD±RW)				
SATA DVD±RW Ultrabay Slim SATA disk	DVD burner, SATA 1.5Gb/s, Ultrabay Slim, removable (43N3214) One modular bay for interchangeable devices (right side), 9.5mm high bay, flat bezel 160GB⁸ (7200 rpm) / SATA 1.5Gb/s, 2.5" wide, 9.5mm high, removable, upgradable, supports 2nd disk, ThinkPad Shock Mounted Hard Drive, Active Protection System™														
Widescreen display	<i>Some</i> : 14.1" (358.1mm) WXGA+ (1440x900) color , anti-glare, CCFL backlight, 200 nits, 16:10 aspect ratio, 300:1 contrast ratio <i>Some</i> : 14.1" (358.1mm) WXGA+ (1440x900) color , anti-glare, LED backlight , 250 nits, 16:10 aspect ratio, 300:1 contrast ratio														
Camera	<i>Some</i> : camera on top of screen, 1.3-megapixel, fixed focus														
Switchable graphics	Switches between discrete and integrated graphics (Vista only), Intel Graphics Media Accelerator 4500MHD (GMA 4500MHD) , in GM45, and ATI™ Mobility Radeon™ HD 3470 , PCI Express x16, 256MB memory, DVI pass-through support to optional Advanced Mini Dock or Advanced Dock; <i>Maximum external resolution</i> : 2048x1536@75Hz (VGA)														
Keyboard TrackPoint® Touch pad ThinkLight™	89-key, ThinkVantage button, spill-resistant, multimedia Fn keys TrackPoint® pointing device, "Press-to-Select," Internet Scroll Bar ¹³ , magnifying glass UltraNav™, wide touch pad below keyboard, Tap Zones, scrolling regions label Illuminates the keyboard to improve visibility in low-light conditions														
Dimensions ³ Weight ² Case material Battery - type Battery - life ¹⁰	<i>6-cell 14.1W"</i> (WxDxH): 13.2" x 9.4" x 1.1-1.3"; 335.5 x 238mm x 28-32mm <i>9-cell</i> : starting at 5.4 lb (2.4kg) <i>Top</i> : Super-Elastic PolyCarbonate (SEPC); <i>Bottom</i> : Carbon-Fiber Reinforced Plastic Lithium Ion 9-cell , supports unique 2nd battery in Ultrabay Slim <i>9-cell</i> : up to 9.8 hr; <i>9-cell plus Ultrabay battery</i> : up to 11.3 hr														
Chipset	Mobile Intel GM45 Express Chipset (Graphics Memory Controller Hub), ICH9M-Enhanced I/O Controller Hub (SATA 3.0Gb/s, USB 2.0, PCI Express® 1.1, PCI 2.3, security chip, ethernet MAC), LPC bus (WPCN385 Super I/O)														
ExpressCard/54 PC Card Smart Card Read Multicard Reader	One slot (ExpressCard/34, ExpressCard/54) One slot (Type I, Type II), CardBus 32-bit None None														
Ports	Three USB 2.0, external monitor (VGA DB-15), modem (RJ-11), ethernet (RJ-45), IEEE 1394 FireWire 400 (4-pin connector; 1394a-2000 standard)										Supports ThinkVantage® technologies				
Mini PCI Express Intel 5100 ²⁸ WWAN upg AT&T ²³ 2G Turbo UWB Modem Bluetooth™ Ethernet Intel AMT Audio support	Three Mini PCI Express slots 11a/b/g/n wireless ⁴ , Mini PCIe adapter, Intel WiFi Link 5100, 1x2 (Shirley Peak) <i>Some</i> : Wireless WAN upgradable, requires Verizon® (43R9151) or AT&T® (43R9152) <i>Some</i> : Wireless WAN, Ericsson chipset, Mini PCIe adapter and SIM, GPRS/WCDMA/HSPA, GPS, service contract required with AT&T® <i>Some</i> : Intel Turbo Memory, Half-Mini PCIe adapter, 2GB flash, disk-cache accelerator None 56K V.92 ⁶ modem Bluetooth 2.0 wireless, LED indicator Intel 82567LM Gigabit Network Connection (Boazman), PHY, PCIe x1 None High Definition (HD) Audio, AD1984HD codec / stereo speakers, 1 watt / volume up, down, mute buttons / digital microphone, microphone input jack, headphone jack										90-watt (ATI graphics) AC adapter ThinkPad Roll Cage and Top Cover Roll Cage (one-piece magnesium) Climate Savers® certified EPEAT™ Silver rating ENERGY STAR® 4.0-compliant RoHS-compliant International Warranty Service ¹⁷ 24 hour x 7 day ¹⁸ toll-free support during the warranty period ¹² via 800-426-7378				
Security Security chip Fingerprint reader	Power-on password, hard disk password, supervisor password, security keyhole Trusted Platform Module, integrated in ICH9M, TCG 1.2-compliant Fingerprint reader on palm rest, swipe sensor, supports the security chip										ThinkPlus™.22 2-year LOR 9x5 NBD 41C9175 ThinkPlus 3-year LOR 9x5 NBD 41C9176 ThinkPlus 4-year LOR 9x5 NBD 41C9177 ThinkPlus 5-year LOR 9x5 NBD 41C9179 ThinkPlus 4-year P&L P/U Depot 41C9178 ThinkPlus 5-year P&L P/U Depot 41C9180				
Limited warranty ¹²	3-years/1-yr battery - EasyServ™.19 depot repair service / service upgrades ²² available										Post-warranty annual maintenance agreements at lenovo.com/thinkplus/warranty				
1GB PC3-8500 DDR3 SODIMM (TopSeller) 43R2045 2GB PC3-8500 DDR3 SODIMM (TopSeller) 43R2046 320GB Disk SATA 1.5Gb/s (5400 rpm) 43N3403 USB 2.0 Portable Secure 320GB Hard Disk 43R2019 USB 2.0 Ultra Secure Memory Key 8GB 45J5918 ThinkPad Advanced Dock 250310U Verizon WWAN UNDP Broadband 43R9151 AT&T WWAN HSPA Broadband Mini PCIe 43R9152 Other accessories on O-T400 sheet	T/R 14W Enhanced Battery 6-cell 41U3198 T/R 14W High Capacity Battery 9-cell 43R2499 90W Slim AC/DC Combo Adapter 41N8460 ThinkPad Business Topload Case 43R2476 T400/R400 Series 14W Privacy Filter 43R2472 ThinkVision® L1940p Wide 19" Monitor 4424HB6 ThinkVision L2240p Wide 22" Monitor 4422HB6 ThinkVision L2440x Wide 24" Monitor 4421HB2 Other accessories at lenovo.com/accessories														

See footnotes for important warranty information

⚡ Intel Centrino® 2 processor technology

© Lenovo

⚡ US model announced October 7, 2008; previous models on August 5 or September 2, 2008

(ML3-2) October 2008

⚡ US model withdrawn effective September 2008

Type-model	Proc- essor GHz Memory	Wide- screen or LED	CCFL or LED	Cam- era	Integrated graphics	Disk SATA GB ³ rpm	SATA optical	Mini PCIe 802.11 wireless	Mini PCIe WWAN	Mini PCIe Bat- tery Blue/ Card or Turbo cells	Fing slot	Whorse (W) Pre- Gbl (G) Avail date
6474-11U	P8400 2.26 1GB 14.1" WXGA				GMA 80G 5400 Combo	Intel 5100 ²⁸	WWAN upg		6 Yes PC	B32 G Aug 08		
6474-R1U	P8400 2.26 2GB 14.1" WXGA			Cam	GMA 160G 5400 Combo	Intel 5100	WWAN upg		6 Yes 7-in-1	B32 WG Aug 08		
6474-R2U	T9400 2.53 2GB 14.1" WXGA			Cam	GMA 160G 7200 DVD±RW	Intel 5100	WWAN upg	2G Turbo	9 Yes PC	B32 WG Aug 08		
6474-R3U	T9400 2.53 2GB 14.1" WXGA			Cam	GMA 160G 5400 DVD±RW	Intel 5100	Verizon ¹⁶		6 Yes 7-in-1	B32 W Aug 08		
6474-P1U	T9400 2.53 2GB 14.1" WXGA				GMA 160G 5400 DVD±RW	Intel 5100	WWAN upg		6 Yes PC	XP G Sep 08		
6474-P2U	P8400 2.26 1GB 14.1" WXGA				GMA 80G 5400 Combo	Intel 5100	WWAN upg		6 Yes PC	XP G Sep 08		
6474-T1U	P8600 2.40 1GB 14.1" WXGA				GMA 160G 5400 DVD±RW	Intel 5100	WWAN upg		6 Smart	B32 TAA Oct 08		
6474-44U	P8400 2.26 3GB 14.1" WXGA			Cam	GMA 160G 5400 Combo	Intel 5100	WWAN upg		6 Yes 7-in-1	B32 WG Nov 08		
6474-45U	T9400 2.53 3GB 14.1" WXGA			Cam	GMA 160G 5400 DVD±RW	Intel 5100	WWAN upg		6 Yes PC	B32 WG Nov 08		
6474-P8U	P8600 2.40 2GB 14.1" WXGA				GMA 160G 5400 DVD±RW	Intel 5100	WWAN upg		6 Yes PC	B32 WG Dec 08		
6474-P9U	P8600 2.40 2GB 14.1" WXGA+ LED				GMA 160G 7200 DVD±RW	Intel 5100	WWAN upg		9 Yes PC	B32 WG Dec 08		
US Govt (TAA) ⁵ Processor	T1U: US Government model (Trade Act Agreement-compliant) Intel® Core™ 2 Duo processor P8400, P8600, or T9400 with dual-core, Intel HD Boost, 1066MHz system bus; P8400/P8600: 3MB L2 cache; T9400: 6MB L2										Preloaded operating system ²⁰ - Some: Microsoft® Windows® XP Professional with Vista® COA - Some: Microsoft Windows Vista Business Edition (32-bit) ◇ Vista Premium logo	
Memory	1GB, 2GB, or 3GB std / 8GB max ⁷ / PC3-8500 1066MHz DDR3, non-parity, dual-channel capable, two 204-pin SO-DIMM sockets; <i>Italics:</i> standard memory in both sockets; no sockets available; <i>Non-italics:</i> standard memory in one socket; one socket available										Preloaded applications ¹⁴ (all OSes) • Rescue and Recovery™ • Access Connections™ • Client Security Solution™ • ThinkVantage Productivity Center • ThinkVantage System Update • McAfee VirusScan® Plus with SiteAdvisor™ (30 days of virus definitions) • PC-Doctor™ (diagnostics) • ThinkPad Utilities (Power Manager and Presentation Director) • Adobe® Reader • Windows Live™ Toolbar • Windows Live Search • Fingerprint Software (fingerprint models) • Microsoft Office 2007 Trial (60-day) • Roxio® Creator® Business Edition • Roxio MyDVD® (DVD±RW)	
SATA Combo SATA DVD±RW Ultrabay Slim SATA disk	Some: CD-RW/DVD-ROM, SATA 1.5Gb/s, 9.5mm Ultrabay Slim, removable (43N3213) Some: DVD burner, SATA 1.5Gb/s, Ultrabay Slim, removable (43N3214) One modular bay for interchangeable devices (right side), 9.5mm high bay, flat bezel 80GB ⁸ (5400 rpm) or 160GB ⁸ (5400 or 7200 rpm) / SATA 1.5Gb/s, 2.5" wide, 9.5mm high, removable, upgradable, supports 2nd disk, ThinkPad Shock Mounted Hard Drive, Active Protection System™											
Widescreen display	Some: 14.1" (358.1mm) WXGA (1280x800) color, anti-glare, CCFL backlight, 185 nits, 16:10 aspect ratio, 300:1 contrast ratio Some: 14.1" (358.1mm) WXGA+ (1440x900) color, anti-glare, LED backlight, 250 nits, 16:10 aspect ratio, 300:1 contrast ratio											
Camera	Some: camera on top of screen, 1.3-megapixel, fixed focus											
Integrated graphics	Intel Graphics Media Accelerator 4500MHD (GMA 4500MHD), in GM45, DVI pass-through support to optional Advanced Mini Dock or Advanced Dock; Maximum external resolution: 2048x1536@75Hz											
Keyboard TrackPoint® Touch pad ThinkLight™	89-key, ThinkVantage button, spill-resistant, multimedia Fn keys TrackPoint® pointing device, "Press-to-Select," Internet Scroll Bar ¹³ , magnifying glass UltraNav™, wide touch pad below keyboard, Tap Zones, scrolling regions label Illuminates the keyboard to improve visibility in low-light conditions											
Dimensions ³ Weight ² Case color Case material Battery - type Battery - life ¹⁰	6-cell 14.1W" (WxDxH): 13.2" x 9.4" x 1.1-1.3"; 335.5 x 238mm x 28-32mm 6-cell: starting at 5.0 lb (2.3kg); 9-cell: starting at 5.4 lb (2.4kg) Black Top: Super-Elastic PolyCarbonate (SEPC); Bottom: Carbon-Fiber Reinforced Plastic Lithium Ion 6-cell or 9-cell, supports unique 2nd battery in Ultrabay Slim 6-cell: up to 6.5 hr; 6-cell plus Ultrabay battery: up to 8.0 hr; 9-cell: up to 9.8 hr											
Chipset	Mobile Intel GM45 Express Chipset (Graphics Memory Controller Hub), ICH9M-Enhanced I/O Controller Hub (SATA 3.0Gb/s, USB 2.0, PCI Express® 1.1, PCI 2.3, security chip, ethernet MAC), LPC bus (WPCN385 Super I/O) Some: One slot (Type I, Type II), CardBus 32-bit										Supports ThinkVantage® technologies	
ExpressCard/54 PC Card Smart Card read Multicard reader Ports	One slot (ExpressCard/34, ExpressCard/54) Some: Smart Card reader Some: 7-in-1 reader (MMC, Memory Stick, Mem Stick Pro, SD, SDHC, XD, XD Type H) Three USB 2.0, external monitor (VGA DB-15), modem (RJ-11), ethernet (RJ-45), IEEE 1394 FireWire 400 (4-pin connector; 1394a-2000 standard)										65-watt (GMA graphics) AC adapter ThinkPad Roll Cage and Top Cover Roll Cage (one-piece magnesium) Climate Savers® certified EPEAT™ Silver rating ENERGY STAR® 4.0-compliant RoHS-compliant International Warranty Service ¹⁷ 24 hour x 7 day ¹⁸ toll-free support during the warranty period ¹² via 800-426-7378	
Mini PCI Express Intel 5100 ²⁸ WWAN upg Verizon ¹⁶ 2G Turbo UWB Modem Bluetooth™ Ethernet Intel AMT Audio support Security Security chip Fingerprint reader	Three Mini PCI Express slots 11a/b/g/n wireless ⁴ , Mini PCIe adapter, Intel WiFi Link 5100, 1x2 (Shirley Peak) Some: Wireless WAN upgradable, requires Verizon® (43R9151) or AT&T® (43R9152) Some: Wireless WAN, Qualcomm chipset, Mini PCIe adapter and SIM, EV-DO Rev. A, GPRS/WCDMA/HSPA, GPS, service contract reqd with Verizon Some: Intel Turbo Memory, Half-Mini PCIe adapter, 2GB flash, disk-cache accelerator None 56K V.92 ⁶ modem Some: Bluetooth 2.0 wireless, LED indicator Intel 82567LM Gigabit Network Connection (Boazman), PHY, PCIe x1 Intel Active Management Technology (IAMT 4.0) High Definition (HD) Audio, AD1984HD codec / stereo speakers, 1 watt / volume up, down, mute buttons / digital microphone, microphone input jack, headphone jack Power-on password, hard disk password, supervisor password, security keyhole Trusted Platform Module, integrated in ICH9M, TCG 1.2-compliant Some: Fingerprint reader on palm rest, swipe sensor, supports the security chip										ThinkPlus™.22 2-year LOR 9x5 NBD 41C9175 ThinkPlus 3-year LOR 9x5 NBD 41C9176 ThinkPlus 4-year LOR 9x5 NBD 41C9177 ThinkPlus 5-year LOR 9x5 NBD 41C9179 ThinkPlus 4-year P&L P/U Depot 41C9178 ThinkPlus 5-year P&L P/U Depot 41C9180 Post-warranty annual maintenance agreements at lenovo.com/thinkplus/warranty	
Limited warranty ¹²	3-years/1-yr battery - EasyServ™.19 depot repair service / service upgrades ²² available											
2GB PC3-8500 DDR3 SODIMM 320GB Disk SATA 1.5Gb/s (5400 rpm) USB 2.0 Portable Secure 320GB Hard Disk ThinkPad Advanced Dock AT&T WWAN HSPA Broadband Mini PCIe Other accessories on O-T400 sheet	43R1988 43N3403 43R2019 250310U 43R9152	T/R 14W High Capacity Battery 9-cell 90W Slim AC/DC Combo Adapter ThinkPad Business Topload Case T400/R400 Series 14W Privacy Filter ThinkVision® L2440p Wide 24" Monitor Other accessories at lenovo.com/accessories	43R2499 41N8460 43R2476 43R2472 4420HB2	ThinkPlus 5-year P&L P/U Depot 41C9180								

See footnotes for important warranty information

◆ Intel Centrino® 2 with vPro™ technology

© Lenovo

Ⓜ US models announced December 2, 2008; previous models on Aug 5, Sep 2, Oct 7, or November 4, 2008

(ML3-3) December 2008

ThinkPad® T400 2767 (Switchable)

Personal Systems Reference (PSREF)

Type-model	Proc-essor	Mem-ory	14.1" wide screen or Cam-LED era	Switchable graphics	Disk SATA GB ⁸ rpm	SATA optical	Mini PCIe 802.11 wireless	Mini PCIe WWAN	Mini PCIe UWB or Turbo	Bat-tery card	Whorse (W) Gbl (G) Avail date	
2767-11U	P8600	2.40	1GB WXGA+	GMA, 3470	80G 5400	Combo	Intel 5100 ²⁸	WWAN upg	Yes	6 PC B32	G Aug08	
2767-12U	T9400	2.53	2GB WXGA+	GMA, 3470	160G 5400	DVD±RW	Intel 5100	WWAN upg	2G Turbo	Yes 9 7-in-1	B32 W G Aug08	
2767-13U	T9400	2.53	2GB WXGA+	GMA, 3470	160G 7200	DVD±RW	Intel 5100	Verizon ¹⁶	2G Turbo	Yes 9 7-in-1	B32 W Aug08	
2767-14U	T9600	2.80	2GB WXGA+	Cam GMA, 3470	160G 7200	DVD±RW	Intel 5100	WWAN upg	2G Turbo	Yes 9 7-in-1	B32 W Aug08	
2767-R2U	T9600	2.80	2GB WXGA+	Cam GMA, 3470	160G 7200	DVD±RW	Intel 5100	WWAN upg	2G Turbo	Yes 9 7-in-1	B64 Aug08	
2767-R9U	T9600	2.80	2GB WXGA+ LED	Cam GMA, 3470	160G 7200	DVD±RW	Intel 5100	Verizon	2G Turbo	Yes 9 7-in-1	B32 W Aug08	
2767-2GU	P8600	2.40	1GB WXGA	GMA, 3470	160G 7200	Combo	Intel 5100	WWAN upg	6 Smart	B32 TAA	Aug08	
2767-2HU	P8600	2.40	2GB WXGA+	GMA, 3470	160G 7200	DVD±RW	Intel 5100	WWAN upg	6 Smart	B32 TAA	Aug08	
2767-2JU	T9400	2.53	2GB WXGA	Cam GMA, 3470	250G 5400	DVD±RW	Intel 5100	WWAN upg	Yes 9	7-in-1 B32 W G	Aug08	
2767-2NU	T9600	2.80	2GB WXGA+ LED	Cam GMA, 3470	64G SSD	DVD±RW	Intel 5300 ²⁸	WWAN upg	Yes 9	PC B32	Sep08	
2767-P1U	T9400	2.53	2GB WXGA+	GMA, 3470	160G 7200	DVD±RW	Intel 5100	WWAN upg	2G Turbo	Yes 9 PC XP	G Sep08	
2767-P6U	P8600	2.40	1GB WXGA+	GMA, 3470	80G 5400	Combo	Intel 5100	WWAN upg	Yes 6	PC XP	G Sep08	
2767-P7U	T9400	2.53	2GB WXGA+	GMA, 3470	160G 5400	DVD±RW	Intel 5100	WWAN upg	2G Turbo	Yes 9 7-in-1 XP	G Sep08	
US Govt (TAA) ⁵ Processor	2GU/2HU: US Government model (Trade Act Agreement-compliant) Intel® Core™ 2 Duo processor P8600, T9400, or T9600 with dual-core, Intel HD Boost, 1066MHz system bus; P8600: 3MB L2 cache; T9400/T9600: 6MB L2 cache								Preloaded operating system²⁰ - Some: Microsoft Windows® XP Professional with Vista® COA - Some: Microsoft Windows Vista Business Edition (32-bit) - Some: Microsoft Windows Vista Business Edition (64-bit) ◇ Vista Premium logo			
Memory	1GB or 2GB std / 8GB max ⁷ / PC3-8500 1066MHz DDR3, non-parity, dual-channel capable, two 204-pin SO-DIMM sockets; <i>Italics:</i> standard memory in both sockets; no sockets available; <i>Non-italics:</i> standard memory in one socket; one socket available								Preloaded applications¹⁴ (all OSes) • Rescue and Recovery™ • Access Connections™ • Client Security Solution™ • ThinkVantage Productivity Center • ThinkVantage System Update • McAfee VirusScan® Plus with SiteAdvisor™ (30 days of virus definitions) • PC-Doctor™ (diagnostics) • ThinkPad Utilities (Power Manager and Presentation Director) • Adobe® Reader • Windows Live™ Toolbar • Windows Live Search • Fingerprint Software (fingerprint models) • Microsoft Office 2007 Trial (60-day) • Roxio® Creator® Business Edition • Roxio MyDVD® (DVD±RW)			
SATA Combo SATA DVD±RW Ultrabay Slim SATA disk	<i>Some:</i> CD-RW/DVD-ROM, SATA 1.5Gb/s, 9.5mm Ultrabay Slim, removable (43N3213) <i>Some:</i> DVD burner, SATA 1.5Gb/s, Ultrabay Slim, removable (43N3214) One modular bay for interchangeable devices (right side), 9.5mm high bay, flat bezel <i>Some:</i> 64GB ⁸ Solid State Drive (SSD) / SATA 3.0Gb/s, 1.8" wide, 8mm high; <i>Some:</i> 80GB ⁸ (5400 rpm), 160GB ⁸ (5400 or 7200 rpm), or 250GB ⁸ (5400 rpm) / SATA 1.5Gb/s, 2.5" wide, 9.5mm high, Active Protection System™ <i>All:</i> removable, upgradable, supports 2nd disk, shock mounted storage											
Widescreen display	<i>Some:</i> 14.1" (358.1mm) WXGA (1280x800) color, anti-glare, CCFL backlight, 185 nits, 16:10 aspect ratio, 300:1 contrast ratio <i>Some:</i> 14.1" (358.1mm) WXGA+ (1440x900) color, anti-glare, CCFL backlight, 200 nits, 16:10 aspect ratio, 300:1 contrast ratio <i>Some:</i> 14.1" (358.1mm) WXGA+ (1440x900) color, anti-glare, LED backlight, 250 nits, 16:10 aspect ratio, 300:1 contrast ratio											
Camera	<i>Some:</i> camera on top of screen, 1.3-megapixel, fixed focus											
Switchable graphics	Switches between discrete and integrated graphics (Vista only), Intel Graphics Media Accelerator 4500MHD (GMA 4500MHD), in GM45, and ATI™ Mobility Radeon™ HD 3470, PCI Express x16, 256MB memory, DVI pass-through support to optional Advanced Mini Dock or Advanced Dock; Maximum external resolution: 2048x1536@75Hz (VGA)											
Keyboard TrackPoint® Touch pad ThinkLight™	89-key, ThinkVantage button, spill-resistant, multimedia Fn keys TrackPoint® pointing device, "Press-to-Select," Internet Scroll Bar ¹³ , magnifying glass UltraNav™, wide touch pad below keyboard, Tap Zones, scrolling regions label Illuminates the keyboard to improve visibility in low-light conditions											
Dimensions ³ Weight ² Case material Battery - type Battery - life ¹⁰	6-cell 14.1W" (WxDxH): 13.2" x 9.4" x 1.1-1.3"; 335.5 x 238mm x 28-32mm 6-cell: starting at 5.0 lb (2.3kg); 9-cell: starting at 5.4 lb (2.4kg) <i>Top:</i> Super-Elastic PolyCarbonate (SEPC); <i>Bottom:</i> Carbon-Fiber Reinforced Plastic Lithium Ion 6-cell or 9-cell, supports unique 2nd battery in Ultrabay Slim 6-cell: up to 6.5 hr; 6-cell plus Ultrabay battery: up to 8.0 hr; 9-cell: up to 9.8 hr								Supports ThinkVantage® technologies			
Chipset	Mobile Intel GM45 Express Chipset (Graphics Memory Controller Hub), ICH9M-Enhanced I/O Controller Hub (SATA 3.0Gb/s, USB 2.0, PCI Express® 1.1, PCI 2.3, security chip, ethernet MAC), LPC bus (WPCN385 Super I/O)								90-watt (ATI graphics) AC adapter ThinkPad Roll Cage and Top Cover Roll Cage (one-piece magnesium) Climate Savers® certified EPEAT™ Gold rating (LED model) EPEAT Silver rating (other models) ENERGY STAR® 4.0-compliant RoHS-compliant International Warranty Service ¹⁷ 24 hour x 7 day ¹⁸ toll-free support during the warranty period ¹² via 800-426-7378			
ExpressCard slot PC Card Std slot Smart Card Read Multicard Reader Ports	One ExpressCard/34 or ExpressCard/54 <i>Some:</i> One Type I or Type II slot, CardBus 32-bit <i>Some:</i> Smart Card Reader <i>Some:</i> 7-in-1 reader (MMC, Memory Stick, Mem Stick Pro, SD, SDHC, XD, XD Type H) Three USB 2.0, external monitor (VGA DB-15), modem (RJ-11), ethernet (RJ-45), IEEE 1394 FireWire 400 (4-pin connector; 1394a-2000 standard)											
Mini PCI Express	Three Mini PCI Express slots <i>Some:</i> 11a/b/g/n wireless ⁴ , Mini PCIe adapter, Intel WiFi Link 5100, 1x2 (Shirley Peak) <i>Some:</i> 11a/b/g/n wireless ⁴ , Mini PCIe adapter, Intel WiFi Link 5300, 3x3 (Shirley Peak) <i>Some:</i> Wireless WAN upgradable, requires Verizon® (43R9151) or AT&T® (43R9152) <i>Some:</i> Wireless WAN, Qualcomm chipset, Mini PCIe adapter and SIM, EV-DO Rev. A, GPRS/WCDMA/HSPA, GPS, service contract reqd with Verizon								ThinkPlus™.22 2-year LOR 9x5 NBD 41C9175			
2G Turbo UWB Modem	<i>Some:</i> Intel Turbo Memory, Half-Mini PCIe adapter, 2GB flash, disk-cache accelerator None 56K V.92 ⁶ modem								ThinkPlus 3-year LOR 9x5 NBD 41C9176			
Bluetooth™ Ethernet Intel AMT Audio support	<i>Some:</i> Bluetooth 2.0 wireless, LED indicator Intel 82567LM Gigabit Network Connection (Boazman), PHY, PCIe x1 Intel Active Management Technology (IAMT 4.0) High Definition (HD) Audio, AD1984HD codec / stereo speakers, 1 watt / volume up, down, mute buttons / digital microphone, microphone input jack, headphone jack Power-on password, hard disk password, supervisor password, security keyhole Trusted Platform Module, integrated in ICH9M, TCG 1.2-compliant <i>Some:</i> Fingerprint reader on palm rest, swipe sensor, supports the security chip								ThinkPlus 4-year LOR 9x5 NBD 41C9177			
Security Security chip Fingerprint reader									ThinkPlus 5-year LOR 9x5 NBD 41C9179			
Limited warranty ¹²	3-years/1-yr battery - EasyServ™.19 depot repair service / service upgrades ²² available								ThinkPlus 4-year P&L P/U Depot 41C9178			
									ThinkPlus 5-year P&L P/U Depot 41C9180			
									Post-warranty annual maintenance agreements at lenovo.com/thinkplus/warranty			

See footnotes for important warranty information

◆ Intel Centrino® 2 with vPro™ technology

© Lenovo

Ⓜ US models announced September 2, 2008; previous models on August 5, 2008

(ML3-4) November 2008

ThinkPad® T400 2767 (Switchable) - October 2008

Type-model	Proc-essor	Mem-ory	14.1" wide CCFL screen or Cam-LED	Switchable graphics	Disk SATA GB ³ rpm	SATA optical	Mini PCIe 802.11 wireless	Mini PCIe WWAN	Mini PCIe UWB or Turbo	Bat-tery	Blue/Fing	Card slot	Whorse (W) Pre- load	(G) Avail date
2767-31U	P8600	2.40	2GB WXGA	Cam	GMA, 3470	160G 7200	DVD±RW	Intel 5300 ²⁸	WWAN upg	Yes	6	7-in-1	Bus32	WG Oct 08
2767-R1U	T9400	2.53	2GB WXGA	Cam	GMA, 3470	160G 7200	DVD±RW	Intel 5100 ²⁸	WWAN upg	UWB	Yes	9	7-in-1	Bus32 Oct 08
2767-R3U	T9400	2.53	2GB WXGA+	Cam	GMA, 3470	160G 7200	DVD±RW	Intel 5300	WWAN upg	UWB	Yes	9	7-in-1	Bus32 W Oct 08
2767-T1U	P8600	2.40	1GB WXGA		GMA, 3470	160G 7200	Combo	Intel 5100	WWAN upg			6	Smart	Bus32 TAA Oct 08
2767-T2U	P8600	2.40	2GB WXGA+		GMA, 3470	160G 7200	DVD±RW	Intel 5100	WWAN upg			6	Smart	Bus32 TAA Oct 08
2767-4AU	T9400	2.53	3GB WXGA+		GMA, 3470	160G 7200	DVD±RW	Intel 5100	WWAN upg	Yes	6	PC	Bus32	WG Nov08
2767-P8U	P8600	2.40	2GB WXGA+		GMA, 3470	160G 7200	DVD±RW	Intel 5100	WWAN upg	Yes	9	PC	Bus32	WG Dec08
2767-P9U	P8600	2.40	2GB WXGA+ LED		GMA, 3470	160G 7200	DVD±RW	Intel 5100	WWAN upg	Yes	9	PC	Bus32	WG Dec08
US Govt (TAA) ⁵ Processor	T1U/T2U: US Government model (Trade Act Agreement-compliant) Intel® Core™ 2 Duo processor P8600 or T9400 with dual-core, Intel HD Boost, 1066MHz system bus; P8600: 3MB L2 cache; T9400: 6MB L2 cache										Preloaded operating system²⁰ - Microsoft® Windows® Vista® Business Edition (32-bit) ↳ Vista Premium logo			
Memory	1GB, 2GB, or 3GB std / 8GB max ⁷ / PC3-8500 1066MHz DDR3 , non-parity, dual-channel capable, two 204-pin SO-DIMM sockets; <i>Italics:</i> standard memory in both sockets; no sockets available; <i>Non-italics:</i> standard memory in one socket; one socket available										Preloaded applications¹⁴ • Rescue and Recovery™ • Access Connections™ • Client Security Solution™ • ThinkVantage Productivity Center • ThinkVantage System Update • McAfee VirusScan® Plus with SiteAdvisor™ (30 days of virus definitions) • PC-Doctor™ (diagnostics) • ThinkPad Utilities (Power Manager and Presentation Director) • Adobe® Reader • Windows Live™ Toolbar • Windows Live Search • Fingerprint Software (fingerprint models) • Microsoft Office 2007 Trial (60-day) • Roxio® Creator® Business Edition • Roxio MyDVD® (DVD±RW)			
SATA Combo SATA DVD±RW Ultrabay Slim SATA disk	<i>Some:</i> CD-RW/DVD-ROM, SATA 1.5Gb/s, 9.5mm Ultrabay Slim, removable (43N3213) <i>Some:</i> DVD burner, SATA 1.5Gb/s, Ultrabay Slim, removable (43N3214) One modular bay for interchangeable devices (right side), 9.5mm high bay, flat bezel 160GB (7200 rpm) / SATA 1.5Gb/s, 2.5" wide, 9.5mm high, removable, upgradable, supports 2nd disk, ThinkPad Shock Mounted Hard Drive, Active Protection System™													
Widescreen display	<i>Some:</i> 14.1" (358.1mm) WXGA (1280x800) color , anti-glare, CCFL backlight, 185 nits, 16:10 aspect ratio, 300:1 contrast ratio <i>Some:</i> 14.1" (358.1mm) WXGA+ (1440x900) color , anti-glare, CCFL backlight, 200 nits, 16:10 aspect ratio, 300:1 contrast ratio <i>Some:</i> 14.1" (358.1mm) WXGA+ (1440x900) color , anti-glare, LED backlight , 250 nits, 16:10 aspect ratio, 300:1 contrast ratio													
Camera	<i>Some:</i> camera on top of screen, 1.3-megapixel, fixed focus													
Switchable graphics	Switches between discrete and integrated graphics (Vista only), Intel Graphics Media Accelerator 4500MHD (GMA 4500MHD) , in GM45, and ATI™ Mobility Radeon™ HD 3470 , PCI Express x16, 256MB memory, DVI pass-through support to optional Advanced Mini Dock or Advanced Dock; <i>Maximum external resolution:</i> 2048x1536 @75Hz													
Keyboard TrackPoint® Touch pad ThinkLight™	89-key, ThinkVantage button, spill-resistant, multimedia Fn keys TrackPoint® pointing device, "Press-to-Select," Internet Scroll Bar ¹³ , magnifying glass UltraNav™, wide touch pad below keyboard, Tap Zones, scrolling regions label Illuminates the keyboard to improve visibility in low-light conditions													
Dimensions ³ Weight ² Case color Case material Battery - type Battery - life ¹⁰	<i>6-cell 14.1W" (WxDxH):</i> 13.2" x 9.4" x 1.1–1.3"; 335.5 x 238mm x 28–32mm <i>6-cell:</i> starting at 5.0 lb (2.3kg); <i>9-cell:</i> starting at 5.4 lb (2.4kg) Black <i>Top:</i> Super-Elastic PolyCarbonate (SEPC); <i>Bottom:</i> Carbon-Fiber Reinforced Plastic Lithium Ion 6-cell or 9-cell , supports unique 2nd battery in Ultrabay Slim <i>6-cell:</i> up to 6.5 hr; <i>6-cell plus Ultrabay battery:</i> up to 8.0 hr; <i>9-cell:</i> up to 9.8 hr													
Chipset	Mobile Intel GM45 Express Chipset (Graphics Memory Controller Hub), ICH9M-Enhanced I/O Controller Hub (SATA 3.0Gb/s, USB 2.0, PCI Express® 1.1, PCI 2.3, security chip, ethernet MAC), LPC bus (WPCN385 Super I/O)													
ExpressCard/54 PC Card Smart Card read Multicard reader Ports	One slot (ExpressCard/34, ExpressCard/54) <i>Some:</i> One slot (Type I, Type II), CardBus 32-bit <i>Some:</i> Smart Card reader <i>Some:</i> 7-in-1 reader (MMC, Memory Stick, Mem Stick Pro, SD, SDHC, XD, XD Type H) Three USB 2.0, external monitor (VGA DB-15), modem (RJ-11), ethernet (RJ-45), IEEE 1394 FireWire 400 (4-pin connector; 1394a-2000 standard)										Supports ThinkVantage® technologies			
Mini PCI Express Intel 5100 ²⁸ Intel 5300 ²⁸ WWAN upg 2G Turbo UWB Modem Bluetooth™ Ethernet Intel AMT Audio support	Three Mini PCI Express slots <i>Some:</i> 11a/b/g/n wireless ⁴ , Mini PCIe adapter, Intel WiFi Link 5100, 1x2 (Shirley Peak) <i>Some:</i> 11a/b/g/n wireless ⁴ , Mini PCIe adapter, Intel WiFi Link 5300, 3x3 (Shirley Peak) Wireless WAN upgradable, requires Verizon® (43R9151) or AT&T® (43R9152) None <i>Some:</i> Wireless USB based on Ultra-Wideband (UWB), Half-Mini PCIe adapter 56K V.92 ⁶ modem <i>Some:</i> Bluetooth 2.0 wireless, LED indicator Intel 82567LM Gigabit Network Connection (Boazman), PHY, PCIe x1 Intel Active Management Technology (IAMT 4.0) High Definition (HD) Audio, AD1984HD codec / stereo speakers, 1 watt / volume up, down, mute buttons / digital microphone, microphone input jack, headphone jack Power-on password, hard disk password, supervisor password, security keyhole Trusted Platform Module, integrated in ICH9M, TCG 1.2-compliant										90-watt (ATI graphics) AC adapter ThinkPad Roll Cage and Top Cover Roll Cage (one-piece magnesium) Climate Savers® certified EPEAT™ Gold rating (LED model) EPEAT Silver rating (other models) ENERGY STAR® 4.0-compliant RoHS-compliant International Warranty Service ¹⁷ 24 hour x 7 day ¹⁸ toll-free support during the warranty period ¹² via 800-426-7378			
Security Security chip Fingerprint reader	Power-on password, hard disk password, supervisor password, security keyhole Trusted Platform Module, integrated in ICH9M, TCG 1.2-compliant <i>Some:</i> Fingerprint reader on palm rest, swipe sensor, supports the security chip										ThinkPlus™.22 2-year LOR 9x5 NBD 41C9175 ThinkPlus 3-year LOR 9x5 NBD 41C9176 ThinkPlus 4-year LOR 9x5 NBD 41C9177 ThinkPlus 5-year LOR 9x5 NBD 41C9179			
Limited warranty ¹²	3-years/1-yr battery - EasyServ™.19 depot repair service / service upgrades ²² available										ThinkPlus 4-year P&L P/U Depot 41C9178 ThinkPlus 5-year P&L P/U Depot 41C9180 Post-warranty annual maintenance agreements at lenovo.com/thinkplus/warranty			
2GB PC3-8500 DDR3 SODIMM	43R1988			T/R 14W High Capacity Battery 9-cell			43R2499							
320GB Disk SATA 1.5Gb/s (5400 rpm)	43N3403			90W Slim AC/DC Combo Adapter			41N8460							
USB 2.0 Portable Secure 320GB Hard Disk	43R2019			ThinkPad Business Backpack			43R2482							
ThinkPad Advanced Dock	250310U			T400/R400 Series 14W Privacy Filter			43R2472							
Verizon WWAN UNDP Broadband	43R9151			ThinkVision® L2440x Wide 24" Monitor			4421HB2							
Other accessories on O-T400 sheet	Other accessories at lenovo.com/accessories													

See footnotes for important warranty information

↳ Intel Centrino® 2 with vPro™ technology

↳ US models announced December 2, 2008; previous models on October 7 or November 4, 2008

Proc- Type-model	essor GHz	Memory	Wide- screen display	CCFL or Cam- LED era	Integrated graphics	Disk SATA GB ³	SATA rpm	optical	Mini PCIe 802.11 wireless	Mini PCIe WWAN	Mini PCIe UWB or Turbo	Bat- tery Blue/ Card Fing slot	Whorse (W) Pre- load Gbl (G) Avail GMP (P) date
6475-11U	P8400	2.26	1GB	14.1" WXGA		GMA 80G	5400	Combo	Intel 5100 ²⁸	WWAN	upg	6 Yes PC	B32 GP Aug08
6475-R1U	P8400	2.26	2GB	14.1" WXGA		Cam GMA 160G	5400	Combo	Intel 5100	WWAN	upg	6 Yes 7-in-1	B32 WGP Aug08
6475-R2U	T9400	2.53	2GB	14.1" WXGA		Cam GMA 160G	7200	DVD±RW	Intel 5100	WWAN	upg	2G Turbo	9 Yes PC B32 WGP Aug08
6475-P1U	T9400	2.53	2GB	14.1" WXGA		GMA 160G	5400	DVD±RW	Intel 5100	WWAN	upg	6 Yes PC	XP GP Sep08
6475-44U	P8400	2.26	3GB	14.1" WXGA		Cam GMA 160G	5400	Combo	Intel 5100	WWAN	upg	6 Yes 7-in-1	B32 WGP Nov08
6475-45U	T9400	2.53	3GB	14.1" WXGA		Cam GMA 160G	5400	DVD±RW	Intel 5100	WWAN	upg	6 Yes PC	B32 WGP Nov08
6475-P8U	P8600	2.40	2GB	14.1" WXGA		GMA 160G	5400	DVD±RW	Intel 5100	WWAN	upg	6 Yes PC	B32 WGP Dec08
6475-P9U	P8600	2.40	2GB	14.1" WXGA+ LED		GMA 160G	7200	DVD±RW	Intel 5100	WWAN	upg	9 Yes PC	B32 WGP Dec08
<p>• These models are part of the Global Models Plus program with limited onsite service²⁴ 3-year limited warranty</p>													
Positioning Processor	<p>Premiere performance; two spindles Intel® Core™ 2 Duo processor P8400 or T9400 with dual-core, Intel HD Boost, 1066MHz system bus; P8400: 3MB L2 cache; T9400: 6MB L2 cache</p>												<p>Preloaded operating system²⁰ - Some: Microsoft® Windows® XP Professional with Vista® COA - Some: Microsoft Windows Vista Business Edition (32-bit) ⇨ Vista Premium logo</p>
Memory	<p>1GB, 2GB, or 3GB std / 8GB max⁷ / PC3-8500 1066MHz DDR3, non-parity, dual-channel capable, two 204-pin SO-DIMM sockets; <i>Italics:</i> standard memory in both sockets; no sockets available; <i>Non-italics:</i> standard memory in one socket; one socket available</p>												<p>Preloaded applications¹⁴ (all OSes) • Rescue and Recovery™ • Access Connections™ • Client Security Solution™ • ThinkVantage Productivity Center • ThinkVantage System Update • McAfee VirusScan® Plus with SiteAdvisor™ (30 days of virus definitions) • PC-Doctor™ (diagnostics) • ThinkPad Utilities (Power Manager and Presentation Director) • Adobe® Reader • Windows Live™ Toolbar • Windows Live Search • Fingerprint Software (fingerprint models) • Microsoft Office 2007 Trial (60-day) • Roxio® Creator® Business Edition • Roxio MyDVD® (DVD±RW)</p>
SATA Combo SATA DVD±RW Ultrabay Slim SATA disk	<p>Some: CD-RW/DVD-ROM, SATA 1.5Gb/s, 9.5mm Ultrabay Slim, removable (43N3213) Some: DVD burner, SATA 1.5Gb/s, Ultrabay Slim, removable (43N3214) One modular bay for interchangeable devices (right side), 9.5mm high bay, flat bezel 80GB⁸ (5400 rpm), 160GB (5400 rpm or 7200 rpm) / SATA 1.5Gb/s, 2.5" wide, 9.5mm high, removable, upgradable, supports 2nd disk, ThinkPad Shock Mounted Hard Drive, Active Protection System™</p>												
Widescreen display	<p>Some: 14.1" (358.1mm) WXGA (1280x800) color, anti-glare, CCFL backlight, 185 nits, 16:10 aspect ratio, 300:1 contrast ratio Some: 14.1" (358.1mm) WXGA+ (1440x900) color, anti-glare, LED backlight, 250 nits, 16:10 aspect ratio, 300:1 contrast ratio</p>												
Camera	<p>Some: camera on top of screen, 1.3-megapixel, fixed focus</p>												
Integrated graphics	<p>Intel Graphics Media Accelerator 4500MHD (GMA 4500MHD), in GM45, DVI pass-through support to optional Advanced Mini Dock or Advanced Dock</p>												
Keyboard TrackPoint® Touch pad ThinkLight™	<p>89-key, ThinkVantage button, spill-resistant, multimedia Fn keys TrackPoint® pointing device, "Press-to-Select," Internet Scroll Bar¹³, magnifying glass UltraNav™, wide touch pad below keyboard, Tap Zones, scrolling regions label Illuminates the keyboard to improve visibility in low-light conditions</p>												
Dimensions ³ Weight ² Case color Case material Battery - type Battery - life ¹⁰	<p><i>6-cell 14.1W" (WxDxH):</i> 13.2" x 9.4" x 1.1–1.3"; 335.5 x 238mm x 28–32mm <i>6-cell:</i> starting at 5.0 lb (2.3kg); <i>9-cell:</i> starting at 5.4 lb (2.4kg) Black Top: Super-Elastic PolyCarbonate (SEPC); Bottom: Carbon-Fiber Reinforced Plastic Lithium Ion 6-cell or 9-cell, supports unique 2nd battery in Ultrabay Slim <i>6-cell:</i> up to 6.5 hr; <i>6-cell plus Ultrabay battery:</i> up to 8.0 hr; <i>9-cell:</i> up to 9.8 hr</p>												
Chipset	<p>Mobile Intel GM45 Express Chipset (Graphics Memory Controller Hub), ICH9M-Enhanced I/O Controller Hub (SATA 3.0Gb/s, USB 2.0, PCI Express® 1.1, PCI 2.3, security chip, ethernet MAC), LPC bus (WPCN385 Super I/O)</p>												
ExpressCard/54 PC Card Smart Card read Multicard reader Ports	<p>One slot (ExpressCard/34, ExpressCard/54) Some: One slot (Type I, Type II), CardBus 32-bit None Some: 7-in-1 reader (MMC, Memory Stick, Mem Stick Pro, SD, SDHC, XD, XD Type H) Three USB 2.0, external monitor (VGA DB-15), modem (RJ-11), ethernet (RJ-45), IEEE 1394 FireWire 400 (4-pin connector; 1394a-2000 standard)</p>												
Mini PCI Express Intel 5100 ²⁸ WWAN upg 2G Turbo UWB Modem Bluetooth™ Ethernet Intel AMT Audio support	<p>Three Mini PCI Express slots 11a/b/g/n wireless⁴, Mini PCIe adapter, Intel WiFi Link 5100, 1x2 (Shirley Peak) Some: Wireless WAN upgradable, requires Verizon® (43R9151) or AT&T® (43R9152) Some: Intel Turbo Memory, Half-Mini PCIe adapter, 2GB flash, disk-cache accelerator None 56K V.92⁶ modem Bluetooth 2.0 wireless, LED indicator Intel 82567LM Gigabit Network Connection (Boazman), PHY, PCIe x1 Intel Active Management Technology (IAMT 4.0) High Definition (HD) Audio, AD1984HD codec / stereo speakers, 1 watt / volume up, down, mute buttons / digital microphone, microphone input jack, headphone jack</p>												
Security Security chip Fingerprint reader	<p>Power-on password, hard disk password, supervisor password, security keyhole Trusted Platform Module, integrated in ICH9M, TCG 1.2-compliant Fingerprint reader on palm rest, swipe sensor, supports the security chip</p>												
Limited warranty ¹²	<p>3-years/1-year battery, limited onsite service²⁴, 8 am - 5 pm, Mon - Fri coverage excluding holidays, next business day response time / service upgrades²² available</p>												
1GB PC3-8500 DDR3 SODIMM 2GB PC3-8500 DDR3 SODIMM Blu-ray Burner Ultrabay Slim 128GB SSD SATA 3.0Gb/s 1.8" (2.5" cover) 320GB Disk SATA 1.5Gb/s (5400 rpm) USB 2.0 Portable Secure 320GB Hard Disk ThinkPad Advanced Dock Verizon WWAN UNDP Broadband AT&T WWAN HSPA Broadband Mini PCIe Other accessories on O-T400 sheet	43R1987 43R1988 43N3215 43N3406 43N3403 43R2019 250310U 43R9151 43R9152	T/R 14W Enhanced Battery 6-cell T/R 14W High Capacity Battery 9-cell Advanced Ultrabay Battery II 3-cell 90W Slim AC/DC Combo Adapter ThinkPad Business Topload Case ThinkPad Business Backpack T400/R400 Series 14W Privacy Filter ThinkVision® L2240p Wide 22" Monitor ThinkVision L2440x Wide 24" Monitor Other accessories at lenovo.com/accessories	41U3198 43R2499 43R9250 41N8460 43R2476 43R2482 43R2472 4422HB6 4421HB2										
<p>Supports ThinkVantage® technologies</p>													
<p>65-watt (GMA graphics) AC adapter ThinkPad Roll Cage and Top Cover Roll Cage (one-piece magnesium) Climate Savers® certified EPEAT™ Silver rating ENERGY STAR® 4.0-compliant RoHS-compliant International Warranty Service¹⁷ 24 hour x 7 day¹⁸ toll-free support during the warranty period¹² via 800-426-7378</p>													
<p>ThinkPlus™.22 4-year LOR 9x5 NBD 12X5630 Post-warranty annual maintenance agreements at lenovo.com/thinkplus/warranty</p>													

See footnotes for important warranty information

⇨ Intel Centrino® 2 with vPro™ technology

Ⓢ US models announced December 2, 2008; previous models on Aug 5, Sep 2, or November 4, 2008

ThinkPad® T400 2768 (Switchable) - Onsite

Personal Systems Reference (PSREF)

Type-model	Proc- essor	Mem- ory	14.1" wide- screen or Cam- era	CCFL LED	Switchable graphics	Disk SATA GB ⁸ rpm	SATA optical	Mini PCIe 802.11 wireless	Mini PCIe WWAN	Mini PCIe UWB or Turbo	Bat- tery Card slot	Pre- load	Whorse (W) GMP (P) Gbl (G)	Avail date
2768-11U	P8600	2.40 1GB	WXGA+		GMA, 3470	80G 5400	Combo	Intel 5100 ²⁸	WWAN upg		6 PC	Bus32	GP Aug08	
2768-12U	T9400	2.53 2GB	WXGA+		GMA, 3470	160G 5400	DVD±RW	Intel 5100	WWAN upg	Turbo	9 7-in-1	Bus32	WGP Aug08	
2768-2JU	T9400	2.53 2GB	WXGA		Cam GMA, 3470	250G 5400	DVD±RW	Intel 5100	WWAN upg		9 7-in-1	Bus32	WGP Aug08	
2768-P1U	T9400	2.53 2GB	WXGA+		GMA, 3470	160G 7200	DVD±RW	Intel 5100	WWAN upg	Turbo	9 PC	XP Pro	GP Aug08	
2768-31U	P8600	2.40 2GB	WXGA		Cam GMA, 3470	160G 7200	DVD±RW	Intel 5300 ²⁸	WWAN upg		6 7-in-1	Bus32	WGP Oct 08	
2768-4AU	T9400	2.53 3GB	WXGA+		GMA, 3470	160G 7200	DVD±RW	Intel 5100	WWAN upg		6 PC	Bus32	WGP Nov08	
2768-P8U	P8600	2.40 2GB	WXGA+		GMA, 3470	160G 7200	DVD±RW	Intel 5100	WWAN upg		9 PC	Bus32	WGP Dec08	
2768-P9U	P8600	2.40 2GB	WXGA+	LED	GMA, 3470	160G 7200	DVD±RW	Intel 5100	WWAN upg		9 PC	Bus32	WGP Dec08	
<p>• These models are part of the Global Models Plus program with limited onsite service²⁴ 3-year limited warranty</p>														
Positioning Processor	<p><i>Premiere performance; two spindles</i> Intel® Core™ 2 Duo processor P8600 or T9400 with dual-core, Intel HD Boost, 1066MHz system bus; <i>P8600</i>: 3MB L2 cache; <i>T9400</i>: 6MB L2 cache</p>											<p>Preloaded operating system²⁰ - <i>Some</i>: Microsoft® Windows® XP Professional with Vista® COA - <i>Some</i>: Microsoft Windows Vista Business Edition (32-bit) ⇨ Vista Premium logo</p>		
Memory	<p>1GB, 2GB, or 3GB std / 8GB max⁷ / PC3-8500 1066MHz DDR3, non-parity, dual-channel capable, two 204-pin SO-DIMM sockets; <i>Italics</i>: standard memory in both sockets; no sockets available; <i>Non-italics</i>: standard memory in one socket; one socket available</p>											<p>Preloaded applications¹⁴ (all OSes) • Rescue and Recovery™ • Access Connections™ • Client Security Solution™ • ThinkVantage Productivity Center • ThinkVantage System Update • McAfee VirusScan® Plus with SiteAdvisor™ (30 days of virus definitions) • PC-Doctor™ (diagnostics) • ThinkPad Utilities (Power Manager and Presentation Director) • Adobe® Reader • Windows Live™ Toolbar • Windows Live Search • Fingerprint Software (fingerprint models) • Microsoft Office 2007 Trial (60-day) • Roxio® Creator® Business Edition • Roxio MyDVD® (DVD±RW)</p>		
SATA Combo SATA DVD±RW Ultrabay Slim SATA disk	<p><i>Some</i>: CD-RW/DVD-ROM, SATA 1.5Gb/s, 9.5mm Ultrabay Slim, removable (43N3213) <i>Some</i>: DVD burner, SATA 1.5Gb/s, Ultrabay Slim, removable (43N3214) One modular bay for interchangeable devices (right side), 9.5mm high bay, flat bezel 80GB⁸ (5400 rpm), 160GB (5400 or 7200 rpm), or 250GB (5400 rpm) / SATA 1.5Gb/s, 2.5" wide, 9.5mm high, removable, upgradable, supports 2nd disk, ThinkPad Shock Mounted Hard Drive, Active Protection System™</p>													
Widescreen display	<p><i>Some</i>: 14.1" (358.1mm) WXGA (1280x800) color, anti-glare, CCFL backlight, 185 nits, 16:10 aspect ratio, 300:1 contrast ratio <i>Some</i>: 14.1" (358.1mm) WXGA+ (1440x900) color, anti-glare, CCFL backlight, 200 nits, 16:10 aspect ratio, 300:1 contrast ratio <i>Some</i>: 14.1" (358.1mm) WXGA+ (1440x900) color, anti-glare, LED backlight, 250 nits, 16:10 aspect ratio, 300:1 contrast ratio</p>													
Camera	<p><i>Some</i>: camera on top of screen, 1.3-megapixel, fixed focus</p>													
Switchable graphics	<p>Switches between discrete and integrated graphics (Vista only), Intel Graphics Media Accelerator 4500MHD (GMA 4500MHD), in GM45, and ATI™ Mobility Radeon™ HD 3470, PCI Express x16, 256MB memory, DVI pass-through support to optional Advanced Mini Dock or Advanced Dock; <i>Maximum external resolution: 2048x1536@75Hz (VGA)</i></p>													
Keyboard TrackPoint® Touch pad ThinkLight™	<p>89-key, ThinkVantage button, spill-resistant, multimedia Fn keys TrackPoint® pointing device, "Press-to-Select," Internet Scroll Bar¹³, magnifying glass UltraNav™, wide touch pad below keyboard, Tap Zones, scrolling regions label Illuminates the keyboard to improve visibility in low-light conditions</p>													
Dimensions ³ Weight ² Case color Case material Battery - type Battery - life ¹⁰	<p><i>6-cell 14.1W"</i> (WxDxH): 13.2" x 9.4" x 1.1-1.3"; 335.5 x 238mm x 28-32mm <i>6-cell</i>: starting at 5.0 lb (2.3kg); <i>9-cell</i>: starting at 5.4 lb (2.4kg) Black <i>Top</i>: Super-Elastic Polycarbonate (SEPC); <i>Bottom</i>: Carbon-Fiber Reinforced Plastic Lithium Ion 6-cell or 9-cell, supports unique 2nd battery in Ultrabay Slim <i>6-cell</i>: up to 6.5 hr; <i>6-cell plus Ultrabay battery</i>: up to 8.0 hr; <i>9-cell</i>: up to 9.8 hr</p>													
Chipset	<p>Mobile Intel GM45 Express Chipset (Graphics Memory Controller Hub), ICH9M-Enhanced I/O Controller Hub (SATA 3.0Gb/s, USB 2.0, PCI Express® 1.1, PCI 2.3, security chip, ethernet MAC), LPC bus (WPCN385 Super I/O)</p>													
ExpressCard/54 PC Card Smart Card read Multicard reader Ports	<p>One slot (ExpressCard/34, ExpressCard/54) <i>Some</i>: One slot (Type I, Type II), CardBus 32-bit None <i>Some</i>: 7-in-1 reader (MMC, Memory Stick, Mem Stick Pro, SD, SDHC, XD, XD Type H) Three USB 2.0, external monitor (VGA DB-15), modem (RJ-11), ethernet (RJ-45), IEEE 1394 FireWire 400 (4-pin connector; 1394a-2000 standard)</p>													
Mini PCI Express Intel 5100 ²⁸ Intel 5300 ²⁸ WWAN upg 2G Turbo UWB	<p>Three Mini PCI Express slots <i>Some</i>: 11a/b/g/n wireless⁴, Mini PCIe adapter, Intel WiFi Link 5100, 1x2 (Shirley Peak) <i>Some</i>: 11a/b/g/n wireless⁴, Mini PCIe adapter, Intel WiFi Link 5300, 3x3 (Shirley Peak) <i>Some</i>: Wireless WAN upgradable, requires Verizon® (43R9151) or AT&T® (43R9152) <i>Some</i>: Intel Turbo Memory, Half-Mini PCIe adapter, 2GB flash, disk-cache accelerator</p>											<p>Supports ThinkVantage® technologies</p>		
Modem Bluetooth™ Ethernet Intel AMT Audio support	<p>56K V.92⁶ modem Bluetooth 2.0 wireless, LED indicator Intel 82567LM Gigabit Network Connection (Boazman), PHY, PCIe x1 Intel Active Management Technology (IAMT 4.0) High Definition (HD) Audio, AD1984HD codec / stereo speakers, 1 watt / volume up, down, mute buttons / digital microphone, microphone input jack, headphone jack</p>											<p>90-watt (ATI graphics) AC adapter ThinkPad Roll Cage and Top Cover Roll Cage (one-piece magnesium) Climate Savers® certified EPEAT™ Silver rating ENERGY STAR® 4.0-compliant RoHS-compliant International Warranty Service¹⁷ 24 hour x 7 day¹⁸ toll-free support during the warranty period¹² via 800-426-7378</p>		
Security Security chip Fingerprint reader	<p>Power-on password, hard disk password, supervisor password, security keyhole Trusted Platform Module, integrated in ICH9M, TCG 1.2-compliant Fingerprint reader on palm rest, swipe sensor, supports the security chip</p>													
Limited warranty ¹²	<p>3-years/1-year battery, limited onsite service²⁴, 8 am - 5 pm, Mon - Fri coverage excluding holidays, next business day response time / service upgrades²² available</p>													
2GB PC3-8500 DDR3 SODIMM 320GB Disk SATA 1.5Gb/s (5400 rpm) ThinkPad Advanced Dock AT&T WWAN HSPA Broadband Mini PCIe Other accessories on O-T400 sheet	43R1988 43N3403 250310U 43R9152	T/R 14W High Capacity Battery 9-cell 90W Slim AC/DC Combo Adapter ThinkPad Business Topload Case ThinkVision® L2440p Wide 24" Monitor Other accessories at lenovo.com/accessories	43R2499 41N8460 43R2476 4420HB2	<p>ThinkPlus™.22 4-year LOR 9x5 NBD 12X5630 Post-warranty annual maintenance agreements at lenovo.com/thinkplus/warranty</p>										

See footnotes for important warranty information

⇨ Intel Centrino® 2 with vPro™ technology

Ⓜ US models announced December 2, 2008; previous models on Aug 5, Sep 2, Oct 7, or November 4, 2008

© Lenovo (ML3-6) December 2008

ThinkPad® T400 6474 (GMA) - Education

Type-model	Proc- essor GHz	Memory	Wide- screen display	Cam- era	Integrated graphics	Disk SATA GB ⁸ rpm	SATA optical	Mini PCIe 802.11 wireless	Mini PCIe WWAN	Mini PCIe UWB or Turbo	Bat- tery Blue/ Card	Workhorse (W) Global (G) Avail date
6474-E1U	P8400	2.26 1GB	14.1" WXGA	Cam	GMA 80G	5400	Combo	Intel 5100	WWAN upg	2G Turbo	6 Yes	PC Card W Aug 08
6474-E2U	T9400	2.53 2GB	14.1" WXGA	Cam	GMA 160G	7200	DVD±RW	Intel 5100	WWAN upg	2G Turbo	9 Yes	7-in-1 W Aug 08
6474-E3U	T9400	2.53 2GB	14.1" WXGA	Cam	GMA 250G	5400	DVD±RW	Intel 5100	WWAN upg	2G Turbo	9 Yes	7-in-1 W Aug 08

• **These models have an EasyServ™¹⁹ depot repair service 3-year limited warranty**

Educational models are available only to public or private K-12 or higher accredited schools organized and operated exclusively for educational purposes for use by qualified students and teachers.

Positioning Processor	<i>Premiere performance; two spindles</i> Intel® Core™ 2 Duo processor P8400 or T9400 with dual-core, 1066MHz system bus; <i>P8400:</i> 3MB L2 cache; <i>T9400:</i> 6MB L2 cache										Preloaded operating system²⁰ - Microsoft® Windows® Vista® Business Edition (32-bit) ⇨ Vista Premium logo Preloaded applications¹⁴ • Education software - Microsoft Office OneNote® 2007 (and CD) - VitalSource Library College Edition - Adobe® Instructor Resource Cntr - Adobe Digital School Collection - Photoshop Elements (and CD) - Premier Elements (and DVD) - Acrobat 8 Professional - Contribute 4 • Rescue and Recovery™ • Access Connections™ • Client Security Solution™ • ThinkVantage Productivity Center • ThinkVantage System Update • McAfee VirusScan® Plus with SiteAdvisor™ (30 days of virus definitions) • PC-Doctor™ (diagnostics) • ThinkPad Utilities (Power Manager and Presentation Director) • Adobe® Reader • Windows Live™ Toolbar • Windows Live Search • Fingerprint Software (fingerprint models) • Microsoft Office 2007 Trial (60-day) • Roxio® Creator® Business Edition • Roxio MyDVD® (DVD±RW)
Memory	1GB or 2GB std / 8GB max ⁷ / PC3-8500 1066MHz DDR3 , non-parity, dual-channel capable, two 204-pin SO-DIMM sockets; <i>Italics:</i> standard memory in both sockets; no sockets available <i>Non-italics:</i> standard memory in one socket; one socket available										
SATA Combo SATA DVD±RW Ultrabay Slim SATA disk	<i>Some:</i> CD-RW/DVD-ROM, SATA 1.5Gb/s, 9.5mm Ultrabay Slim, removable (43N3213) <i>Some:</i> DVD burner, SATA 1.5Gb/s, Ultrabay Slim, removable (43N3214) One modular bay for interchangeable devices (right side), 9.5mm high bay, flat bezel 80GB⁸ (5400 rpm), 160GB (7200 rpm), or 250GB (5400 rpm) / SATA 1.5Gb/s, 2.5" wide, 9.5mm high, removable, upgradable, supports 2nd disk, ThinkPad Shock Mounted Hard Drive, Active Protection System™										
Widescreen display Camera	14.1" (358.1mm) WXGA (1280x800) color , anti-glare, CCFL backlight, 185 nits, 16:10 aspect ratio, 300:1 contrast ratio Camera on top of screen, 1.3-megapixel, fixed focus										
Integrated graphics	Intel Graphics Media Accelerator 4500MHD (GMA 4500MHD) , in GM45, DVI pass-through support to optional Advanced Mini Dock or Advanced Dock; <i>Maximum external resolution:</i> 2048x1536 @75Hz										
Keyboard TrackPoint® Touch pad ThinkLight™	89-key, ThinkVantage button, spill-resistant, multimedia Fn keys TrackPoint® pointing device, "Press-to-Select," Internet Scroll Bar ¹³ , magnifying glass UltraNav™, wide touch pad below keyboard, Tap Zones, scrolling regions label Illuminates the keyboard to improve visibility in low-light conditions										
Dimensions ³ Weight ² Case material Battery - type Battery - life ¹⁰	<i>6-cell 14.1W" (WxDxH):</i> 13.2" x 9.4" x 1.1–1.3"; 335.5 x 238mm x 28–32mm <i>6-cell:</i> starting at 5.0 lb (2.3kg); <i>9-cell:</i> starting at 5.4 lb (2.4kg) <i>Top:</i> Super-Elastic PolyCarbonate (SEPC); <i>Bottom:</i> Carbon-Fiber Reinforced Plastic Lithium Ion 6-cell or 9-cell , supports unique 2nd battery in Ultrabay Slim <i>6-cell:</i> up to 6.5 hr; <i>6-cell plus Ultrabay battery:</i> up to 8.0 hr; <i>9-cell:</i> up to 9.8 hr										
Chipset	Mobile Intel GM45 Express Chipset (Graphics Memory Controller Hub), ICH9M-Enhanced I/O Controller Hub (SATA 3.0Gb/s, USB 2.0, PCI Express® 1.1, PCI 2.3, security chip, ethernet MAC), LPC bus (WPCN385 Super I/O) One ExpressCard/34 or ExpressCard/54 <i>Some:</i> One Type I or Type II slot, CardBus 32-bit										
ExpressCard slot PC Card Std slot Smart Card Read Multicard Reader Ports	<i>Some:</i> 7-in-1 reader (MMC, Memory Stick, Mem Stick Pro, SD, SDHC, XD, XD Type H) Three USB 2.0, external monitor (VGA DB-15), modem (RJ-11), ethernet (RJ-45), IEEE 1394 FireWire 400 (4-pin connector; 1394a-2000 standard)										
Mini PCI Express	Three Mini PCI Express slots Intel 5100 ²⁸ WWAN upg 2G Turbo UWB Modem Bluetooth™ Ethernet Intel AMT Audio support										
Security Security chip Fingerprint reader	Power-on password, hard disk password, supervisor password, security keyhole Trusted Platform Module, integrated in ICH9M, TCG 1.2-compliant Fingerprint reader on palm rest, swipe sensor, supports the security chip										65-watt (GMA graphics) AC adapter ThinkPad Roll Cage and Top Cover Roll Cage (one-piece magnesium) Climate Savers® certified EPEAT™ Silver rating ENERGY STAR® 4.0-compliant RoHS-compliant International Warranty Service ¹⁷ 24 hour x 7 day ¹⁸ toll-free support during the warranty period ¹² via 800-426-7378
Limited warranty ¹²	3-years/1-yr battery - EasyServ™ ¹⁹ depot repair service / service upgrades ²² available										ThinkPlus™. ²² 2-year LOR 9x5 NBD 41C9175 ThinkPlus 3-year LOR 9x5 NBD 41C9176 ThinkPlus 4-year LOR 9x5 NBD 41C9177 ThinkPlus 5-year LOR 9x5 NBD 41C9179 ThinkPlus 4-year P&L P/U Depot 41C9178 ThinkPlus 5-year P&L P/U Depot 41C9180
1GB PC3-8500 DDR3 SODIMM 2GB PC3-8500 DDR3 SODIMM Blu-ray Burner Ultrabay Slim Serial ATA Hard Drive Bay Adapter II 128GB SSD SATA 3.0Gb/s 1.8" (2.5" cover) 320GB Disk SATA 1.5Gb/s (5400 rpm) USB 2.0 Portable Secure 320GB Hard Disk USB 2.0 Super Multi-Burner Drive ThinkPad Advanced Dock Verizon WWAN UNDP Broadband AT&T WWAN HSPA Broadband Mini PCIe Other accessories on O-T400 sheet	43R1987 43R1988 43N3215 43R1980 43N3406 43N3403 43R2019 41N5565 250310U 43R9151 43R9152	T/R 14W Standard Battery 4-cell T/R 14W Enhanced Battery 6-cell T/R 14W High Capacity Battery 9-cell Advanced Ultrabay Battery II 3-cell 90W Slim AC/DC Combo Adapter ThinkPad Business Topload Case ThinkPad Business Backpack T400/R400 Series 14W Privacy Filter ThinkVision® L1940p Wide 19" Monitor ThinkVision L2240p Wide 22" Monitor ThinkVision L2440x Wide 24" Monitor Other accessories at lenovo.com/accessories	41U3196 41U3198 43R2499 43R9250 41N8460 43R2476 43R2482 43R2472 4424HB6 4422HB6 4421HB2	Post-warranty annual maintenance agreements at lenovo.com/thinkplus/warranty							

See footnotes for important warranty information
US models announced August 5, 2008

⇨ Intel Centrino® 2 with vPro™ technology

ThinkPad® T400 2767 (Switchable) - Education

Personal Systems Reference (PSREF)

Type-model	Processor	GHz	Memory	Wide-screen display	Camera	Switchable graphics	Disk SATA GB ³ rpm	SATA optical	Mini PCIe 802.11 wireless	Mini PCIe WWAN	Mini PCIe UWB or Turbo cells	Battery Card	Workhorse (W) Global (G) Avail date
2767-E1U	T9400	2.53	2GB	14.1" WXGA+Cam	GMA, HD 3470	160G 5400 DVD±RW	✦ Intel 5100 ²⁸	WWAN upg	2G Turbo	9	7-in-1	W	Aug 08
2767-E2U	T9400	2.53	2GB	14.1" WXGA+Cam	GMA, HD 3470	160G 7200 DVD±RW	✦ Intel 5100	WWAN upg	2G Turbo	9	7-in-1	W	Aug 08

• **These models have an EasyServ™¹⁹ depot repair service 3-year limited warranty**

Educational models are available only to public or private K-12 or higher accredited schools organized and operated exclusively for educational purposes for use by qualified students and teachers.

Positioning Processor	<i>Premiere performance; two spindles</i> Intel® Core™ 2 Duo processor T9400 with dual-core , Intel HD Boost, and 6MB L2 cache										Preloaded operating system²⁰ - Microsoft® Windows® Vista® Business Edition (32-bit) ✦ Vista Premium logo		
Memory	2GB std / 8GB max ⁷ / PC3-8500 1066MHz DDR3 , non-parity, dual-channel capable, two 204-pin SO-DIMM sockets; <i>Italics:</i> standard memory in both sockets; no sockets available; <i>Non-italics:</i> standard memory in one socket; one socket available										Preloaded applications¹⁴ • Education software - Microsoft Office OneNote® 2007 (and CD) - VitalSource Library College Edition - Adobe® Instructor Resource Cntr - Adobe Digital School Collection - Photoshop Elements (and CD) - Premier Elements (and DVD) - Acrobat 8 Professional - Contribute 4 • Rescue and Recovery™ • Access Connections™ • Client Security Solution™ • ThinkVantage Productivity Center • ThinkVantage System Update • McAfee VirusScan® Plus with SiteAdvisor™ (30 days of virus definitions) • PC-Doctor™ (diagnostics) • ThinkPad Utilities (Power Manager and Presentation Director) • Adobe® Reader • Windows Live™ Toolbar • Windows Live Search • Fingerprint Software (fingerprint models) • Microsoft Office 2007 Trial (60-day) • Roxio® Creator® Business Edition • Roxio MyDVD® (DVD±RW)		
SATA DVD±RW Ultrabay Slim SATA disk	<i>Some:</i> DVD burner, SATA 1.5Gb/s, Ultrabay Slim, removable (43N3214) One modular bay for interchangeable devices (right side), 9.5mm high bay, flat bezel 160GB⁸ (5400 or 7200rpm) / SATA 1.5Gb/s, 2.5" wide, 9.5mm high, removable, upgradable, supports 2nd disk, ThinkPad Shock Mounted Hard Drive, Active Protection System™												
Widescreen display	14.1" (358.1mm) WXGA+ (1440x900) color , anti-glare, CCFL backlight, 200 nits, 16:10 aspect ratio, 300:1 contrast ratio												
Camera	Camera on top of screen, 1.3-megapixel, fixed focus												
Switchable graphics	Switches between discrete and integrated graphics (Vista only), Intel Graphics Media Accelerator 4500MHD (GMA 4500MHD) , in GM45, and ATI™ Mobility Radeon™ HD 3470 , PCI Express x16, 256MB memory, DVI pass-through support to optional Advanced Mini Dock or Advanced Dock; <i>Maximum external resolution:</i> 2048x1536@75Hz												
Keyboard	89-key, ThinkVantage button, spill-resistant, multimedia Fn keys												
TrackPoint®	TrackPoint® pointing device, "Press-to-Select," Internet Scroll Bar ¹³ , magnifying glass												
Touch pad	UltraNav™, wide touch pad below keyboard, Tap Zones, scrolling regions label												
ThinkLight™	Illuminates the keyboard to improve visibility in low-light conditions												
Dimensions ³	<i>6-cell 14.1W" (WxDxH):</i> 13.2" x 9.4" x 1.1–1.3"; 335.5 x 238mm x 28–32mm												
Weight ²	<i>9-cell:</i> starting at 5.4 lb (2.4kg)												
Case material	<i>Top:</i> Super-Elastic PolyCarbonate (SEPC); <i>Bottom:</i> Carbon-Fiber Reinforced Plastic												
Battery - type	Lithium Ion 9-cell , supports unique 2nd battery in Ultrabay Slim												
Battery - life ¹⁰	<i>9-cell:</i> up to 9.8 hr; <i>9-cell plus Ultrabay battery:</i> up to 11.3 hr												
Chipset	Mobile Intel GM45 Express Chipset (Graphics Memory Controller Hub), ICH9M-Enhanced I/O Controller Hub (SATA 3.0Gb/s, USB 2.0, PCI Express® 1.1, PCI 2.3, security chip, ethernet MAC), LPC bus (WPCN385 Super I/O)												
ExpressCard slot	One ExpressCard/34 or ExpressCard/54												
PC Card Std slot	None												
Smart Card Read	None												
Multicard Reader	7-in-1 reader (MMC, Memory Stick, Mem Stick Pro, SD, SDHC, XD, XD Type H)												
Ports	Three USB 2.0, external monitor (VGA DB-15), modem (RJ-11), ethernet (RJ-45), IEEE 1394 FireWire 400 (4-pin connector; 1394a-2000 standard)										Supports ThinkVantage® technologies		
Mini PCI Express	Three Mini PCI Express slots												
Intel 5100 ²⁸	11a/b/g/n wireless ⁴ , Mini PCIe adapter, Intel WiFi Link 5100, 1x2 (Shirley Peak)												
WWAN upg	<i>Some:</i> Wireless WAN upgradable, requires Verizon® (43R9151) or AT&T® (43R9152)												
2G Turbo	Intel Turbo Memory, Half-Mini PCIe adapter, 2GB flash, disk-cache accelerator												
UWB	None												
Modem	56K V.92 ⁶ modem												
Bluetooth™	Bluetooth 2.0 wireless, LED indicator												
Ethernet	Intel 82567LM Gigabit Network Connection (Boazman), PHY, PCIe x1												
Intel AMT	Intel Active Management Technology (IAMT 4.0)												
Audio support	High Definition (HD) Audio, AD1984HD codec / stereo speakers, 1 watt / volume up, down, mute buttons / digital microphone, microphone input jack, headphone jack												
Security	Power-on password, hard disk password, supervisor password, security keyhole												
Security chip	Trusted Platform Module, integrated in ICH9M, TCG 1.2-compliant												
Fingerprint reader	Fingerprint reader on palm rest, swipe sensor, supports the security chip												
Limited warranty ¹²	3-years/1-yr battery - EasyServ™¹⁹ depot repair service / service upgrades²² available												
1GB PC3-8500 DDR3 SODIMM	43R1987			T/R 14W Enhanced Battery 6-cell			41U3198						
2GB PC3-8500 DDR3 SODIMM	43R1988			T/R 14W High Capacity Battery 9-cell			43R2499						
Blu-ray Burner Ultrabay Slim	43N3215			Advanced Ultrabay Battery II 3-cell			43R9250						
Serial ATA Hard Drive Bay Adapter II	43R1980			90W Slim AC/DC Combo Adapter			41N8460						
128GB SSD SATA 3.0Gb/s 1.8" (2.5" cover)	43N3406			ThinkPad Business Topload Case			43R2476						
320GB Disk SATA 1.5Gb/s (5400 rpm)	43N3403			ThinkPad Business Backpack			43R2482						
USB 2.0 Portable Secure 320GB Hard Disk	43R2019			T400/R400 Series 14W Privacy Filter			43R2472						
USB 2.0 Super Multi-Burner Drive	41N5565			ThinkVision® L1940p Wide 19" Monitor			4424HB6						
ThinkPad Advanced Dock	250310U			ThinkVision L2240p Wide 22" Monitor			4422HB6						
AT&T WWAN HSPA Broadband Mini PCIe	43R9152			ThinkVision L2440p Wide 24" Monitor			4420HB2						
Other accessories on O-T400 sheet											Other accessories at lenovo.com/accessories		
											ThinkPlus™.22 2-year LOR 9x5 NBD 41C9175		
											ThinkPlus 3-year LOR 9x5 NBD 41C9176		
											ThinkPlus 4-year LOR 9x5 NBD 41C9177		
											ThinkPlus 5-year LOR 9x5 NBD 41C9179		
											ThinkPlus 4-year P&L P/U Depot 41C9178		
											ThinkPlus 5-year P&L P/U Depot 41C9180		
											Post-warranty annual maintenance agreements at lenovo.com/thinkplus/warranty		

See footnotes for important warranty information
US models announced August 5, 2008

✦ Intel Centrino® 2 with vPro™ technology

© Lenovo
(ML3-8) August 2008

Partial list of accessories supported on:

• ThinkPad T400 originally announced on August 5, 2008

Memory

1GB PC3-8500 DDR3 SODIMM (TopSeller)	43R2045	ann	11/04/08
1GB PC3-8500 DDR3 SODIMM	43R1987	ann	08/05/08
2GB PC3-8500 DDR3 SODIMM (TopSeller)	43R2046	ann	11/04/08
2GB PC3-8500 DDR3 SODIMM	43R1988	ann	08/05/08

Ultrabay Slim 9.5mm

Serial ATA Hard Drive Bay Adapter II SATA	43R1980	ann	08/05/08
DVD-ROM Ultrabay Slim SATA 1.5Gb/s	43N3212	ann	08/05/08
CD-RW/DVD-ROM Ultrabay Slim SATA	43N3213	ann	08/05/08
DVD Burner Ultrabay Slim SATA 1.5Gb/s	43N3214	ann	08/05/08
Blu-ray™ Burner Ultrabay Slim SATA 1.5Gb/s	43N3215	ann	08/05/08

Storage and removable storage

160GB Disk SATA 1.5Gb/s (5400 rpm) ⁴¹	41N5692	ann	03/20/07
160GB Disk SATA 1.5Gb/s (7200 rpm) ⁴¹	41N5737	ann	10/16/07
200GB Disk FDE SATA 1.5Gb/s (7200 rpm) ⁴¹	41N5738	ann	10/16/07
250GB Disk SATA 1.5Gb/s (5400 rpm) ⁴¹	43R8152	ann	01/15/08
320GB Disk SATA 1.5Gb/s (5400 rpm) ⁴¹	43N3403	ann	08/05/08

⁴¹ Can be used as the main HDD or with Serial ATA Hard Drive Bay Adapter 43R1980 in the Ultrabay or (in the ThinkPad Advanced Dock 250310U with Serial Hard Drive Ultrabay Slim Adapter 40Y8725)

128GB SSD SATA 3.0Gb/s 1.8" (2.5" cover)	43N3406	ann	08/26/08
USB 2.0 Essential Memory Key 4GB	45J7904	ann	06/24/08
USB 2.0 Essential Memory Key 8GB	45J7905	ann	07/15/08
USB 2.0 Essential Memory Key 32GB	45K1258	ann	10/28/08
USB 2.0 Security Memory Key 2GB	41U5119	ann	07/17/07
USB 2.0 Security Memory Key 4GB	41U5120	ann	07/17/07
USB 2.0 Ultra Secure Memory Key 2GB	45J5916	ann	08/26/08
USB 2.0 Ultra Secure Memory Key 4GB	45J5917	ann	08/26/08
USB 2.0 Ultra Secure Memory Key 8GB	45J5918	ann	08/26/08
USB Portable Diskette Drive	05K9276	ann	06/05/00
USB 2.0 CD-RW/DVD-ROM Combo II Drive	40Y8637	ann	01/05/06
USB 2.0 Portable 160GB Hard Disk	43R1784	ann	09/23/08
USB 2.0 Portable Secure 160GB Hard Disk	43R2018	ann	11/18/08
USB 2.0 Portable Secure 320GB Hard Disk	43R2019	ann	11/18/08
USB 2.0 Super Multi-Burner Drive	41N5565	ann	01/23/07

Wireless WAN (Mini PCI Express)

Verizon® WWAN UNDP Broadband Mini PCIe	43R9151	ann	08/05/08
AT&T® WWAN HSPA Broadband Mini PCIe	43R9152	ann	08/26/08

ThinkPad Expansion

USB 2.0 Lenovo Enhanced Port Replicator	43R8770	ann	02/26/08
ThinkPad Adjustable Notebook Stand	40Y7676	ann	09/20/05
ThinkPad Essential Port Replicator	250510W	ann	09/20/05
ThinkPad Advanced Mini Dock	250410U	ann	09/20/05
ThinkPad Advanced Dock	250310U	ann	09/20/05

Keyboard

TrackPoint Cap Collection	73P2698	ann	12/16/03
USB Numeric Keypad	33L3225	ann	05/01/00
Preferred Pro USB Keyboard	73P5220	ann	06/21/05
Enhanced Performance USB Keyboard	73P2620	ann	03/23/04
Wireless Kybd & Opt Wheel Mouse (via USB)	73P4067	ann	12/07/04
USB Keyboard with UltraNav	31P8950	ann	01/28/03
USB Travel Keyboard with UltraNav	31P9490	ann	04/27/04
Lenovo USB Fingerprint Keyboard	73P4730	ann	02/22/05

Mouse

Optical Wheel Mouse (USB)	06P4069	ann	05/21/03
Optical ScrollPoint® Mouse (USB, PS/2)	31P7405	ann	08/27/02
Optical Wheel Travel Mouse (USB, PS/2)	31P7410	ann	06/04/02
Laser Tilt Wheel Mouse (USB, PS/2)	41U3074	ann	01/23/07
Lenovo Wireless Laser Mouse (blk, via USB)	45K1696	ann	11/25/08
Lenovo Wireless Laser Mouse (red, via USB)	51J0198	ann	11/25/08
Laser Tilt Wheel Travel Mouse (Bluetooth)	41U5008	ann	01/22/08

Security

Kensington® Cable Lock from Lenovo	73P2582	ann	12/29/03
Kensington Twin Head Cable Lock	45K1620	ann	09/30/08
T400/R400 Series 14W Privacy Filter	43R2472	ann	08/05/08
USB Gemplus GemPC Smart Card Reader	41N3040	ann	02/21/06
PC Card Gemplus Smart Card Reader	41N3004	ann	12/13/05
ExpressCard Gemplus Smart Card Reader	41N3043	ann	06/27/06

Multimedia

USB 2.0 Lenovo Multimedia Headset	40Y8518	ann	06/27/06
USB 2.0 Lenovo Webcam	40Y8519	ann	08/29/06

Batteries

T/R 14W Standard Battery 4-cell	41U3196	ann	05/09/07
T/R 14W Enhanced Battery 6-cell	41U3198	ann	05/09/07
T/R 14W High Capacity Battery 9-cell	43R2499	ann	03/04/08
Advanced Ultrabay Battery II 3-cell ⁴³	43R9250	ann	04/22/08
⁴³ Used in Ultrabay Slim bay.			
ThinkPad External Battery Charger ⁴⁴	40Y7625	ann	09/20/05
⁴⁴ Requires the ThinkPad 90W AC Adapter 40Y7659 (adapter provided with some systems).			

More information at www.lenovo.com/alldaycomputing

ThinkPad 65W AC Adapter ⁴⁵	40Y7696	ann	01/05/06
⁴⁵ Only compatible with the GM45 chipset models.			
ThinkPad 90W AC Adapter	40Y7659	ann	09/20/05
ThinkPad 90W Slim AC/DC Combo Adapter	41N8460	ann	11/27/07

More info at www.lenovo.com/support/poweradapters

Charging tips for 90W Slim AC/DC Combo Adapter 41N8460

• Dual (ThinkPad+Phone) Charging Y-Cable	41R4345	ann	12/18/07
• BlackBerry charge tip (L8a)	41R4478	ann	12/18/07
• iPod and iPhone charge tip (L10a)	41R4481	ann	12/18/07

More information at www.lenovo.com/support/slimadaptertips

Carrying Cases

Up to 14.1" widescreen models:

ThinkPad Expander Case	43R9118	ann	06/24/08
ThinkPad Women's Microfiber Tote	22P8855		
ThinkPad Women's Leather Trim Tote	22P8856		
ThinkPad Convertible Carrying Case	22P8860		
ThinkPad Women's Executive Leather Tote	22P8857		
Women's Executive Red Leather Tote	22P8858		

Up to 15.4" widescreen models:

Lenovo Carrying Case - Messenger Max	41U5253	ann	05/01/07
Lenovo Carr Case - Performance Backpack	41U5254	ann	05/01/07
Lenovo Standard Case	45K1697	ann	11/25/08
Lenovo Standard Backpack	45K1698	ann	11/25/08
ThinkPad Business Topload Case	43R2476	ann	05/13/08
ThinkPad Business Backpack	43R2482	ann	05/13/08
ThinkPad Deluxe Expander Case	43R2478	ann	05/13/08
ThinkPad Executive Leather Case	43R2480	ann	05/13/08

Up to 17.0" widescreen models:

ThinkPad 17W Business Topload Case	43R9117	ann	08/12/08
------------------------------------	---------	-----	----------

Lenovo luxury cases at www.lenovoluxurycases.com

Monitors

ThinkVision® L174 17" Monitor	9227AE1	ann	04/15/08
ThinkVision L1700p 17" Monitor	9417HE2	ann	09/17/08
ThinkVision L1900p 19" Monitor	4431HE1	ann	11/11/08
ThinkVision L1940p Wide 19" Monitor	4424HB6	ann	09/17/08
ThinkVision L200p Wide 20.1" Monitor	4438HB6	ann	04/15/08
ThinkVision L2240p Wide 22" Monitor	4422HB6	ann	09/17/08
ThinkVision L2440p Wide 24" Monitor	4420HB2	ann	09/17/08
ThinkVision L2440x Wide 24" Monitor	4421HB2	ann	09/17/08

Monitor Accessories⁴⁶

ThinkVision USB Soundbar	40Y7616	ann	08/23/05
ThinkVision Soundbar	45K1263	ann	09/16/08
Kensington Cable Lock from Lenovo	73P2582	ann	12/29/03
Kensington Twin Head Cable Lock	45K1620	ann	09/30/08
ThinkPad Convertible Monitor Stand	40Y7620	ann	01/05/06
Radial Arm	19K4464	ann	05/05/00

⁴⁶ Compatible on selected Lenovo and ThinkVision monitors.

More information at www.lenovo.com/support/monitoraccessories

Other accessories at www.lenovo.com/accessories

Accessories Guide pdf at www.lenovo.com/accessoriesguide



Lenovo ThinkPad T500



Lenovo ThinkPad T500



Lenovo ThinkPad T500



ThinkPad Business Topload Case
part number 43R2476



Lenovo ThinkPad T500



Lenovo ThinkPad T500

ThinkPad® T500 2242 (GMA) - TopSeller

Personal Systems Reference (PSREF)

Type-model	Processor GHz	Memory	Wide-screen display	CCFL or LED	Cam-era	Integrated graphics	Disk SATA GB ⁸ rpm	SATA optical	Mini PCIe 802.11 wireless	Mini PCIe WWAN	Mini PCIe UWB or Turbo	Finger print reader	Blue-tooth	Intel AMT	Pre-load	Avail date
2242-22U	P8400	2.26 2GB	15.4"	WXGA		GMA 160G	5400 DVD±RW		Intel 5100 ²⁸	AT&T ²³		Fing			Bus 32	Aug 08
2242-23U	T9400	2.53 2GB	15.4"	WXGA	Cam	GMA 160G	7200 DVD±RW		Intel 5100	AT&T		Fing Blue			XP Pro	Aug 08
2242-32U	P8400	2.26 2GB	15.4"	WXGA		GMA 160G	7200 DVD±RW		Intel 5100	AT&T		Fing Blue			Bus 32	Aug 08
2242-33U	P8400	2.26 2GB	15.4"	WXGA		GMA 160G	5400 DVD±RW		Intel 5100	WWAN upg		Fing			XP Pro	Aug 08
2242-34U	T9400	2.53 2GB	15.4"	WXGA	Cam	GMA 160G	7200 DVD±RW		Intel 5100	WWAN upg	2G Turbo	Fing Blue			Bus 32	Aug 08
2242-35U	P8400	2.26 2GB	15.4"	WXGA		GMA 160G	7200 DVD±RW		Intel 5100	WWAN upg		Fing Blue			XP Pro	Aug 08
2242-4EU	P8400	2.26 1GB	15.4"	WXGA		GMA 160G	5400 Combo		Intel 5100	AT&T					Bus 32	Aug 08
2242-4FU	P8400	2.26 1GB	15.4"	WXGA		GMA 160G	5400 Combo		Intel 5100	WWAN upg					XP Pro	Aug 08
2242-55U	T9400	2.53 2GB	15.4"	WXGA	Cam	GMA 160G	7200 DVD±RW		Intel 5100	WWAN upg		Fing Blue			XP Pro	Sep 08
2242-5FU	P8400	2.26 1GB	15.4"	WXGA		GMA 160G	5400 DVD±RW		Intel 5100	WWAN upg					XP Pro	Sep 08
2242-5GU	P8400	2.26 2GB	15.4"	WXGA	LED	GMA 160G	5400 DVD±RW		Intel 5100	WWAN upg		Fing			XP Pro	Sep 08
2242-5HU	P8400	2.26 2GB	15.4"	WXGA	LED	GMA 160G	7200 DVD±RW		Intel 5100	WWAN upg		Fing Blue			XP Pro	Sep 08
2242-6BU	P8600	2.40 2GB	15.4"	WXGA	LED	GMA 160G	5400 DVD±RW		WiMAX	WWAN upg		Fing		AMT	Bus 32	Jan 09
2242-6CU	P8600	2.40 2GB	15.4"	WXGA	LED	GMA 128G	SSD DVD±RW		Intel 5100	WWAN upg		Fing Blue		AMT	XP Pro	Jan 09

• These small and medium business (SMB) models are part of the US TopSeller™ Program

Processor	Intel® Core™ 2 Duo processor P8400, P8600, or T9400 with dual-core, Intel HD Boost, 1066MHz system bus; P8400/P8600: 3MB L2 cache; T9400: 6MB L2 cache	Preloaded operating system ²⁰ - Some: Microsoft® Windows® XP Professional with Vista® COA - Some: Microsoft Windows Vista Business Edition (32-bit) ◇ Vista Premium logo
Memory	1GB or 2GB std / 8GB max ⁷ / PC3-8500 1066MHz DDR3, non-parity, dual-channel capable, two 204-pin SO-DIMM sockets; <i>Italics:</i> standard memory in both sockets; no sockets available; <i>Non-italics:</i> standard memory in one socket; one socket available	
SATA Combo SATA DVD±RW Ultrabay Slim SATA disk	<i>Some:</i> CD-RW/DVD-ROM, SATA 1.5Gb/s, 9.5mm Ultrabay Slim, removable (43N3213) <i>Some:</i> DVD burner, SATA 1.5Gb/s, 9.5mm Ultrabay slim, removable (43N3214) One modular bay for interchangeable devices (right side), 9.5mm high bay, flat bezel <i>Some:</i> 128GB ⁸ Solid State Drive (SSD) / SATA 3.0Gb/s, 1.8" wide, 8mm high <i>Some:</i> 160GB ⁸ (5400 or 7200 rpm) / SATA 1.5Gb/s, 2.5" wide, 9.5mm high, Active Protection System™ <i>All:</i> removable, upgradable, supports second disk, Shock Mounted Hard Drive	Preloaded applications ¹⁴ (all OSes) • Rescue and Recovery™ • Access Connections™ • Client Security Solution™ • ThinkVantage Productivity Center • ThinkVantage System Update • McAfee VirusScan® Plus with SiteAdvisor™ (30 days of virus definitions) • PC-Doctor™ (diagnostics) • ThinkPad Utilities (Power Manager and Presentation Director) • Adobe® Reader • Windows Live™ Toolbar • Windows Live Search • Fingerprint Software (fingerprint models) • Microsoft Office 2007 Trial (60-day) • Roxio® Creator® Business Edition • Roxio MyDVD® (DVD±RW)
Widescreen display	<i>Some:</i> 15.4" (391mm) WXGA (1280x800) color, anti-glare, CCFL backlight, 200 nits, 16:10 aspect ratio, 300:1 contrast ratio <i>Some:</i> 15.4" (391mm) WXGA (1280x800) color, anti-glare, LED backlight, 190 nits, 16:10 aspect ratio, 300:1 contrast ratio	Supports ThinkVantage® technologies
Camera	<i>Some:</i> camera on top of screen, 1.3-megapixel, fixed focus	
Integrated graphics	Intel Graphics Media Accelerator 4500MHD (GMA 4500MHD), in GM45, digital monitor support via DisplayPort (supports single-link DVI-D via cable 45J7915); <i>Maximum external resolution:</i> 2048x1536@75Hz	65-watt (GMA graphics) AC adapter ThinkPad Roll Cage and Top Cover Roll Cage (one-piece magnesium) Climate Savers® certified EPEAT™ Silver rating ENERGY STAR® 4.0-compliant RoHS-compliant International Warranty Service ¹⁷ 24 hour x 7 day ¹⁸ toll-free support during the warranty period ¹² via 800-426-7378
Keyboard TrackPoint® Touch pad ThinkLight™	89-key, ThinkVantage button, spill-resistant, multimedia Fn keys TrackPoint® pointing device, "Press-to-Select," Internet Scroll Bar ¹³ , magnifying glass UltraNav™, wide touch pad below keyboard, Tap Zones, scrolling regions label Illuminates the keyboard to improve visibility in low-light conditions	
Dimensions ³ Weight ² Case color Case material Battery - type Battery - life ¹⁰	6-cell 15.4W ⁹ (WxDxH): 14.1" x 10" x 1.2-1.3"; 357.5mm x 255mm x 30-34mm 6-cell: starting at 5.9 lb (2.7kg) Black Top: Super-Elastic PolyCarbonate (SEPC); Bottom: Carbon-Fiber Reinforced Plastic Lithium Ion 6-cell, supports unique 2nd battery in Ultrabay Slim 6-cell: up to 6.3 hr; 6-cell plus Ultrabay battery: up to 7.8 hr; 9-cell: up to 9.4 hr	ThinkPlus™.22 1-year LOR 9x5 NBD 41C9166 ThinkPlus 2-year LOR 9x5 NBD 41C9167 ThinkPlus 3-year LOR 9x5 NBD 41C9168 ThinkPlus 4-year LOR 9x5 NBD 41C9171 ThinkPlus 5-year LOR 9x5 NBD 41C9173 ThinkPlus 2-year P&L P/U Depot 41C9169 ThinkPlus 3-year P&L P/U Depot 41C9170 ThinkPlus 4-year P&L P/U Depot 41C9172 ThinkPlus 5-year P&L P/U Depot 41C9174
Chipset	Mobile Intel GM45 Express Chipset (Graphics Memory Controller Hub), ICH9M-Enhanced I/O Controller Hub (SATA 3.0Gb/s, USB 2.0, PCI Express® 1.1, PCI 2.3, security chip, ethernet MAC), LPC bus (WPCN385 Super I/O)	
ExpressCard/54 PC Card Smart Card read Multicard reader Ports	One slot (ExpressCard/34, ExpressCard/54) One slot (Type I, Type II), CardBus 32-bit None 7-in-1 reader (MMC, Memory Stick, Mem Stick Pro, SD, SDHC, XD, XD Type H) Three USB 2.0, external monitor (VGA DB-15, DisplayPort), modem (RJ-11), ethernet (RJ-45), IEEE 1394 FireWire 400 (4-pin connector; 1394a-2000 standard)	
Mini PCI Express Intel 5100 ²⁸ WiMAX WWAN upg AT&T ²³ 2G Turbo UWB Modem Bluetooth™ Ethernet Intel AMT Audio support	Three Mini PCI Express slots <i>Some:</i> 11a/b/g/n wireless ⁴ , Mini PCIe adapter, Intel WiFi Link 5100, 1x2 (Shirley Peak) <i>Some:</i> 11a/b/g/n and WiMAX wireless ⁴ , Mini PCIe adap, Intel WiMAX/WiFi Link 5350, 3x3 (450Mbps) WiFi + 1x2 WiMAX (Echo Peak) <i>Some:</i> Wireless WAN upgradable, requires Verizon® (43R9151) or AT&T® (43R9152) <i>Some:</i> Wireless WAN, Ericsson chipset, Mini PCIe adapter and SIM, GPRS/WCDMA/HSPA, GPS, service contract required with AT&T <i>Some:</i> Intel Turbo Memory, Half-Mini PCIe adapter, 2GB flash, disk-cache accelerator None 56K V.92 ⁶ modem <i>Some:</i> Bluetooth 2.0 wireless, LED indicator Intel 82567LM Gigabit Network Connection (Boazman), PHY, PCIe x1 <i>Some:</i> Intel Active Management Technology (IAMT 4.0) High Definition (HD) Audio, Conexant 20561 codec / stereo speakers, 1 watt / volume up, down, mute buttons / digital microphone, microphone input jack, headphone jack	
Security Security chip Fingerprint reader	Power-on password, hard disk password, supervisor password, security keyhole Trusted Platform Module, integrated in ICH9M, TCG 1.2-compliant <i>Some:</i> Fingerprint reader on palm rest, swipe sensor, supports the security chip	
Limited warranty ¹²	1-year - EasyServ™.19 depot repair service / service upgrades ²² available	Post-warranty annual maintenance agreements at lenovo.com/thinkplus/warranty
Other accessories on O-T500 sheet	Other accessories at lenovo.com/accessories	

See footnotes for important warranty information

◇ Intel Centrino® 2 processor technology

Ⓜ US models announced January 6, 2009; previous models on August 5 or September 23, 2008

 US models withdrawn effective September 2008

© Lenovo
(CR-5) January 2009

ThinkPad® T500 2243 (GMA) - TopSeller

Personal Systems Reference (PSREF)

Type-model	Proc- essor	GHz	Memory	Wide- screen display	Cam- era	Integrated graphics	Disk SATA GB ⁸ rpm	SATA optical	Mini PCIe 802.11 wireless	Mini PCIe WWAN	Mini PCIe UWB or Turbo	Finger print reader	Blue- tooth	Preload	Avail date
2243-56U	P8400	2.26	2GB	15.4" WXGA	None	GMA	160G 5400	DVD±RW	Intel 5100 ²⁸	WWAN upg	None	Finger	None	XP Pro	Sep 08

• These small and medium business (SMB) models are part of the US TopSeller™ Program

Processor	Intel® Core™ 2 Duo processor P8400 with dual-core, Intel HD Boost, 1066MHz system bus, and 3MB L2 cache										Preloaded operating system²⁰ - Microsoft® Windows® XP Professional with Vista® COA ↳ Vista Premium logo				
Memory	2GB std / 8GB max ⁷ / PC3-8500 1066MHz DDR3 , non-parity, dual-channel capable, two 204-pin SO-DIMM sockets; <i>Non-italics:</i> standard memory in one socket; one socket available										Preloaded applications¹⁴ • Rescue and Recovery™ • Access Connections™ • Client Security Solution™ • ThinkVantage Productivity Center • ThinkVantage System Update • McAfee VirusScan® Plus with SiteAdvisor™ (30 days of virus definitions) • PC-Doctor™ (diagnostics) • ThinkPad Utilities (Power Manager and Presentation Director) • Adobe® Reader • Windows Live™ Toolbar • Windows Live Search • Fingerprint Software (fingerprint models) • Microsoft Office 2007 Trial (60-day) • Roxio® Creator® Business Edition • Roxio MyDVD® (DVD±RW)				
SATA DVD±RW Ultrabay Slim SATA disk	DVD burner, SATA 1.5Gb/s, 9.5mm Ultrabay slim, removable (43N3214) One modular bay for interchangeable devices (right side), 9.5mm high bay, flat bezel 160GB⁸ (5400 rpm) / SATA 1.5Gb/s, 2.5" wide, 9.5mm high, removable, upgradable, supports 2nd disk, ThinkPad Shock Mounted Hard Drive, Active Protection System™														
Widescreen display	15.4" (391mm) WXGA (1280x800) color , anti-glare, CCFL backlight, 200 nits, 16:10 aspect ratio, 300:1 contrast ratio														
Camera	None														
Integrated graphics	Intel Graphics Media Accelerator 4500MHD (GMA 4500MHD) , in GM45, digital monitor support via DisplayPort (supports single-link DVI-D via cable 45J7915); <i>Maximum external resolution:</i> 2048x1536@75Hz														
Keyboard	89-key, ThinkVantage button, spill-resistant, multimedia Fn keys														
TrackPoint®	TrackPoint® pointing device, "Press-to-Select," Internet Scroll Bar ¹³ , magnifying glass														
Touch pad	UltraNav™, wide touch pad below keyboard, Tap Zones, scrolling regions label														
ThinkLight™	Illuminates the keyboard to improve visibility in low-light conditions														
Dimensions ³	<i>6-cell 15.4W"</i> (WxDxH): 14.1" x 10" x 1.2-1.3"; 357.5mm x 255mm x 30-34mm														
Weight ²	<i>6-cell:</i> starting at 5.9 lb (2.7kg)														
Case color	Black														
Case material	<i>Top:</i> Super-Elastic PolyCarbonate (SEPC); <i>Bottom:</i> Carbon-Fiber Reinforced Plastic														
Battery - type	Lithium Ion 6-cell , supports unique 2nd battery in Ultrabay Slim														
Battery - life ¹⁰	<i>6-cell:</i> up to 6.3 hr; <i>6-cell plus Ultrabay battery:</i> up to 7.8 hr; <i>9-cell:</i> up to 9.4 hr														
Chipset	Mobile Intel GM45 Express Chipset (Graphics Memory Controller Hub), ICH9M-Enhanced I/O Controller Hub (SATA 3.0Gb/s, USB 2.0, PCI Express® 1.1, PCI 2.3, security chip, ethernet MAC), LPC bus (WPCN385 Super I/O)														
ExpressCard/54	One slot (ExpressCard/34, ExpressCard/54)														
PC Card	One slot (Type I, Type II), CardBus 32-bit														
Smart Card read	None														
Multicard reader	7-in-1 reader (MMC, Memory Stick, Mem Stick Pro, SD, SDHC, XD, XD Type H)														
Ports	Three USB 2.0, external monitor (VGA DB-15, DisplayPort), modem (RJ-11), ethernet (RJ-45), IEEE 1394 FireWire 400 (4-pin connector; 1394a-2000 standard)														
Mini PCI Express	Three Mini PCI Express slots														
Intel 5100 ²⁸	11a/b/g/n wireless ⁴ , Mini PCIe adapter, Intel WiFi Link 5100, 1x2 (Shirley Peak)														
WWAN upg	Wireless WAN upgradable, requires Verizon® (43R9151) or AT&T® (43R9152)														
2G Turbo	None														
UWB	None														
Modem	56K V.92 ⁶ modem														
Bluetooth™	None														
Ethernet	Intel 82567LM Gigabit Network Connection (Boazman), PHY, PCIe x1														
Intel AMT	None														
Audio support	High Definition (HD) Audio, Conexant 20561 codec / stereo speakers, 1 watt / volume up, down, mute buttons / digital microphone, microphone input jack, headphone jack														
Security	Power-on password, hard disk password, supervisor password, security keyhole														
Security chip	Trusted Platform Module, integrated in ICH9M, TCG 1.2-compliant														
Fingerprint reader	None														
Limited warranty ¹²	3-years/1-yr battery - EasyServ™ ¹⁹ depot repair service / service upgrades ²² available														
1GB PC3-8500 DDR3 SODIMM (TopSeller)	43R2045	T/R/W/SL Series Li-Ion Battery 6-cell	40Y6799	ThinkPlus™.22 2-year LOR 9x5 NBD	41C9175										
2GB PC3-8500 DDR3 SODIMM (TopSeller)	43R2046	T/R/W/SL Series Li-Ion Battery 9-cell	40Y6797	ThinkPlus 3-year LOR 9x5 NBD	41C9176										
Blu-ray Burner Ultrabay Slim SATA 1.5Gb/s	43N3215	Advanced Ultrabay Battery II 3-cell	43R9250	ThinkPlus 4-year LOR 9x5 NBD	41C9177										
Serial ATA Hard Drive Bay Adapter II SATA	43R1980	ThinkPad 90W AC Adapter	40Y7659	ThinkPlus 5-year LOR 9x5 NBD	41C9179										
128GB SSD SATA 3.0Gb/s 1.8" (2.5" cover)	43N3406	90W Slim AC/DC Combo Adapter	41N8460	ThinkPlus 4-year P&L P/U Depot	41C9178										
320GB Disk SATA 1.5Gb/s (5400 rpm)	43N3403	ThinkPad Business Topload Case	43R2476	ThinkPlus 5-year P&L P/U Depot	41C9180										
USB 2.0 Portable Secure 320GB Hard Disk	43R2019	ThinkPad Business Backpack	43R2482	Post-warranty annual maintenance agreements at											
USB 2.0 Super Multi-Burner Drive	41N5565	T500/R500/W500 15W Privacy Filter	43R2474	lenovo.com/thinkplus/warranty											
ThinkPad Advanced Dock	250310U	ThinkVision® L1940p Wide 19" Monitor	4424HB6												
Verizon WWAN UNDP Broadband	43R9151	ThinkVision L2240p Wide 22" Monitor	4422HB6												
AT&T WWAN HSPA Broadband Mini PCIe	43R9152	ThinkVision L2440x Wide 24" Monitor	4421HB2												
Other accessories on O-T500 sheet		Other accessories at lenovo.com/accessories													

See footnotes for important warranty information
US model announced September 23, 2008

• Intel Centrino® 2 processor technology

© Lenovo
(CR5-11) December 2008

ThinkPad® T500 2082 (Switchable) - TopSeller

Personal Systems Reference (PSREF)

Proc- Type-model	essor GHz	Memory	Wide- screen display	Cam- era	Switchable graphics	Disk SATA GB ⁸ rpm	SATA optical	Mini PCIe 802.11 wireless	Mini PCIe WWAN	Mini PCIe UWB or Turbo	Bat- tery Intel cells AMT	Preload	Avail date
2082-26U	P8400	2.26	2GB	15.4" WSXGA+	GMA, HD 3650	160G	7200	DVD±RW	Intel 5100 ²⁸	AT&T ²³	9	Bus 32	Aug 08
2082-27U	T9400	2.53	2GB	15.4" WSXGA+ Cam	GMA, HD 3650	160G	7200	DVD±RW	Intel 5100	AT&T	9	XP Pro	Aug 08
2082-3GU	T9400	2.53	2GB	15.4" WSXGA+ Cam	GMA, HD 3650	160G	7200	DVD±RW	Intel 5100	WWAN upg	2G Turbo	9	Bus 32 Aug 08
2082-3HU	P8400	2.26	2GB	15.4" WSXGA+	GMA, HD 3650	160G	7200	DVD±RW	Intel 5100	WWAN upg	9	XP Pro	Aug 08
2082-5XU	T9400	2.53	2GB	15.4" WSXGA+ Cam	GMA, HD 3650	160G	7200	DVD±RW	Intel 5100	WWAN upg	9	XP Pro	Sep 08
2082-7YU	P8600	2.40	2GB	15.4" WSXGA+	GMA, HD 3650	160G	7200	DVD±RW	Intel 5100	WWAN upg	2G Turbo	9 AMT	Bus 32 Jan 09

• These small and medium business (SMB) models are part of the US TopSeller™ Program

Positioning Processor	Premiere performance; two spindles Intel® Core™ 2 Duo processor P8400, P8600, or T9400 with dual-core, Intel HD Boost, 1066MHz system bus; <i>P8400/P8600</i> : 3MB L2 cache; <i>T9400</i> : 6MB L2 cache										Preloaded operating system²⁰ - Some: Microsoft® Windows® XP Professional with Vista® COA - Some: Microsoft Windows Vista Business Edition (32-bit) ◇ Vista Premium logo		
Memory	2GB std / 8GB max ⁷ / PC3-8500 1066MHz DDR3 , non-parity, dual-channel capable, two 204-pin SO-DIMM sockets; <i>Italics</i> : standard memory in both sockets; no sockets available; <i>Non-italics</i> : standard memory in one socket; one socket available										◇ Vista Premium logo		
SATA DVD±RW Ultrabay Slim SATA disk	DVD burner, SATA 1.5Gb/s, Ultrabay Slim, removable (43N3214) One modular bay for interchangeable devices (right side), 9.5mm high bay, flat bezel 160GB⁸ (7200 rpm) / SATA 1.5Gb/s, 2.5" wide, 9.5mm high, removable, upgradable, supports 2nd disk, ThinkPad Shock Mounted Hard Drive, Active Protection System™										Preloaded applications¹⁴ (all OSes) • Rescue and Recovery™ • Access Connections™ • Client Security Solution™ • ThinkVantage Productivity Center • ThinkVantage System Update • McAfee VirusScan® Plus with SiteAdvisor™ (30 days of virus definitions) • PC-Doctor™ (diagnostics) • ThinkPad Utilities (Power Manager and Presentation Director) • Adobe® Reader • Windows Live™ Toolbar • Windows Live Search • Fingerprint Software (fingerprint models) • Microsoft Office 2007 Trial (60-day) • Roxio® Creator® Business Edition • Roxio MyDVD® (DVD±RW)		
Widescreen display	15.4" (391mm) WSXGA+ (1680x1050) color , anti-glare, CCFL backlight, 200 nits, 16:10 aspect ratio, 500:1 contrast ratio												
Camera	Some: camera on top of screen, 1.3-megapixel, fixed focus												
Switchable graphics	Switches between discrete and integrated graphics (Vista only), Intel Graphics Media Accelerator 4500MHD (GMA 4500MHD) , in GM45, and ATI™ Mobility Radeon™ HD 3650 , PCI Express x16, 256MB memory, digital monitor support via DisplayPort (supports single-link DVI-D via cable 45J7915); <i>Maximum external resolution: 2048x1536@75Hz</i>												
Keyboard	89-key, ThinkVantage button, spill-resistant, multimedia Fn keys												
TrackPoint®	TrackPoint® pointing device, "Press-to-Select," Internet Scroll Bar ¹³ , magnifying glass												
Touch pad	UltraNav™, wide touch pad below keyboard, Tap Zones, scrolling regions label												
ThinkLight™	Illuminates the keyboard to improve visibility in low-light conditions												
Dimensions ³	<i>6-cell 15.4W"</i> (WxDxH): 14.1" x 10" x 1.2–1.3"; 357.5mm x 255mm x 30–34mm												
Weight ²	<i>9-cell</i> : starting at 6.2 lb (2.8kg)												
Case color	Black												
Case material	<i>Top</i> : Super-Elastic PolyCarbonate (SEPC); <i>Bottom</i> : Carbon-Fiber Reinforced Plastic												
Battery - type	Lithium Ion 9-cell , supports unique 2nd battery in Ultrabay Slim												
Battery - life ¹⁰	<i>9-cell</i> : up to 9.4 hr; <i>9-cell plus Ultrabay battery</i> : up to 10.9 hr												
Chipset	Mobile Intel GM45 Express Chipset (Graphics Memory Controller Hub), ICH9M-Enhanced I/O Controller Hub (SATA 3.0Gb/s, USB 2.0, PCI Express® 1.1, PCI 2.3, security chip, ethernet MAC), LPC bus (WPCN385 Super I/O)												
ExpressCard/54	One slot (ExpressCard/34 or ExpressCard/54)												
PC Card	One slot (Type I, Type II), CardBus 32-bit												
Smart Card read	None												
Multicard reader	7-in-1 reader (MMC, Memory Stick, Mem Stick Pro, SD, SDHC, XD, XD Type H)												
Ports	Three USB 2.0, external monitor (VGA DB-15, DisplayPort), modem (RJ-11), ethernet (RJ-45), IEEE 1394 FireWire 400 (4-pin connector; 1394a-2000 standard)												
Mini PCI Express	Three Mini PCI Express slots										Supports ThinkVantage® technologies		
Intel 5100 ²⁸	11a/b/g/n wireless ⁴ , Mini PCIe adapter, Intel WiFi Link 5100, 1x2 (Shirley Peak)												
WWAN upg	Some: Wireless WAN upgradable, requires Verizon® (43R9151) or AT&T® (43R9152)												
AT&T ²³	Some: Wireless WAN, Ericsson chipset, Mini PCIe adapter and SIM, GPRS/WCDMA/HSPA, GPS, service contract required with AT&T												
2G Turbo	Some: Intel Turbo Memory, Half-Mini PCIe adapter, 2GB flash, disk-cache accelerator												
UWB	None												
Modem	56K V.92 ⁶ modem												
Bluetooth™	Bluetooth 2.0 wireless, LED indicator												
Ethernet	Intel 82567LM Gigabit Network Connection (Boazman), PHY, PCIe x1												
Intel AMT	Some: Intel Active Management Technology (IAMT 4.0)												
Audio support	High Definition (HD) Audio, Conexant 20561 codec / stereo speakers, 1 watt / volume up, down, mute buttons / digital microphone, microphone input jack, headphone jack												
Security	Power-on password, hard disk password, supervisor password, security keyhole												
Security chip	Trusted Platform Module, integrated in ICH9M, TCG 1.2-compliant												
Fingerprint reader	Fingerprint reader on palm rest, swipe sensor, supports the security chip												
Limited warranty ¹²	3-years/1-yr battery - EasyServ™ ¹⁹ depot repair service / service upgrades ²² available												
1GB PC3-8500 DDR3 SODIMM (TopSeller)	43R2045	T/R/W/SL Series Li-Ion Battery 6-cell	40Y6799										
2GB PC3-8500 DDR3 SODIMM (TopSeller)	43R2046	T/R/W/SL Series Li-Ion Battery 9-cell	40Y6797										
Blu-ray Burner Ultrabay Slim	SATA 1.5Gb/s 43N3215	Advanced Ultrabay Battery II 3-cell	43R9250										
128GB SSD SATA 3.0Gb/s 1.8" (2.5" cover)	43N3406	ThinkPad 90W AC Adapter	40Y7659										
320GB Disk SATA 1.5Gb/s (5400 rpm)	43N3403	90W Slim AC/DC Combo Adapter	41N8460										
USB 2.0 Portable Secure 320GB Hard Disk	43R2019	ThinkPad Business Topload Case	43R2476										
ThinkPad Advanced Dock	250310U	T500/R500/W500 15W Privacy Filter	43R2474										
Verizon WWAN UNDP Broadband	43R9151	ThinkVision® L2240p Wide 22" Monitor	4422HB6										
AT&T WWAN HSPA Broadband Mini PCIe	43R9152	ThinkVision L2440x Wide 24" Monitor	4421HB2										
Other accessories on O-T500 sheet											Other accessories at lenovo.com/accessories		

See footnotes for important warranty information

◆ Intel Centrino® 2 processor technology

© Lenovo

Ⓜ US model announced January 6, 2009; previous models on August 5 or September 23, 2008

(CR5-2) January 2009

Ⓧ US model withdrawn effective September 2008

Type-model	Proc- essor GHz	Memory	Wide- screen display	CCFL or LED	Cam- era	Integrated graphics	Disk SATA GB ³ rpm	SATA optical	Mini PCIe 802.11 wireless	Mini PCIe WWAN	Mini PCIe Bat- tery UWB or Turbo	Blue/Car- d Fing slot	Whorse (W) Gbl (G) Avail Preload date
2089-2JU	P8400	2.26	1GB	15.4"	WXGA		GMA 80G 5400 Combo	✦ Intel 5100 ²⁸	WWAN upg		6 Yes	PC	B32 G Aug 08
2089-2KU	T9400	2.53	2GB	15.4"	WXGA		GMA 160G 5400 DVD±RW	✦ Intel 5100	WWAN upg	2G Turbo	6 Yes	PC	B32 WG Aug 08
2089-2LU	T9400	2.53	2GB	15.4"	WXGA		GMA 160G 5400 DVD±RW	✦ Intel 5100	Verizon ¹⁶	2G Turbo	9 Yes	PC	B32 W Aug 08
2089-2MU	T9400	2.53	2GB	15.4"	WXGA		GMA 160G 7200 DVD±RW	✦ Intel 5100	WWAN upg		6 Yes	PC	B32 W Aug 08
2089-3HU	T9400	2.53	2GB	15.4"	WXGA		GMA 160G 5400 DVD±RW	✦ Intel 5100	WWAN upg		6 Yes	PC	B32 G Aug 08
2089-3JU	T9400	2.53	2GB	15.4"	WXGA		GMA 160G 5400 DVD±RW	✦ Intel 5100	AT&T ²³	2G Turbo	9 Yes	PC	B32 W Aug 08
2089-4XU	T9400	2.53	2GB	15.4"	WXGA	LED	GMA 160G 5400 DVD±RW	✦ Intel 5100	WWAN upg		6 Yes	PC	B32 WG Sep 08
2089-58U	T9400	2.53	2GB	15.4"	WXGA		GMA 160G 5400 DVD±RW	✦ Intel 5100	WWAN upg		6 Yes	PC	XP G Sep 08
2089-59U	P8400	2.26	1GB	15.4"	WXGA		GMA 80G 5400 Combo	✦ Intel 5100	WWAN upg		6 Yes	PC	XP Sep 08
2089-5WU	P8600	2.40	2GB	15.4"	WSXGA+		GMA 160G 5400 DVD±RW	✦ Intel 5100	WWAN upg		6	Smart	B32 TAA Oct 08
2089-5ZU	P8600	2.40	2GB	15.4"	WXGA	LED	GMA 160G 5400 DVD±RW	✦ Intel 5100	WWAN upg		6 Yes	PC	B32 WG Dec 08
US Govt (TAA) ⁵ Processor	5WU: US Government model (Trade Act Agreement-compliant) Intel® Core™ 2 Duo processor P8400, P8600, or T9400 with dual-core, Intel HD Boost, 1066MHz system bus; P8400/P8600: 3MB L2 cache; T9400: 6MB L2 cache												
Memory	1GB or 2GB std / 8GB max ⁷ / PC3-8500 1066MHz DDR3 , non-parity, dual-channel capable, two 204-pin SO-DIMM sockets; <i>Italics:</i> standard memory in both sockets; no sockets available; <i>Non-italics:</i> standard memory in one socket; one socket available												
SATA Combo SATA DVD±RW Ultrabay Slim SATA disk	<i>Some:</i> CD-RW/DVD-ROM, SATA 1.5Gb/s, 9.5mm Ultrabay Slim, removable (43N3213) <i>Some:</i> DVD burner, SATA 1.5Gb/s, Ultrabay Slim, removable (43N3214) One modular bay for interchangeable devices (right side), 9.5mm high bay, flat bezel 80GB⁸ (5400 rpm) or 160GB⁸ (5400 or 7200 rpm) / SATA 1.5Gb/s, 2.5" wide, 9.5mm high, removable, upgradable, supports 2nd disk, ThinkPad Shock Mounted Hard Drive, Active Protection System™												
Widescreen display	<i>Some:</i> 15.4" (391mm) WXGA (1280x800) color , anti-glare, CCFL backlight, 200 nits, 16:10 aspect ratio, 300:1 contrast ratio <i>Some:</i> 15.4" (391mm) WXGA (1280x800) color , anti-glare, LED backlight , 190 nits, 16:10 aspect ratio, 300:1 contrast ratio <i>Some:</i> 15.4" (391mm) WSXGA+ (1680x1050) color , anti-glare, CCFL backlight, 200 nits, 16:10 aspect ratio, 500:1 contrast ratio												
Camera	<i>Some:</i> camera on top of screen, 1.3-megapixel, fixed focus												
Integrated graphics	Intel Graphics Media Accelerator 4500MHD (GMA 4500MHD) , in GM45, digital monitor support via DisplayPort (supports single-link DVI-D via cable 45J7915); <i>Maximum external resolution:</i> 2048x1536 @75Hz (VGA, DisplayPort)												
Keyboard TrackPoint® Touch pad ThinkLight™	89-key, ThinkVantage button, spill-resistant, multimedia Fn keys TrackPoint® pointing device, "Press-to-Select," Internet Scroll Bar ¹³ , magnifying glass UltraNav™, wide touch pad below keyboard, Tap Zones, scrolling regions label Illuminates the keyboard to improve visibility in low-light conditions												
Dimensions ³ Weight ² Case color Case material Battery - type Battery - life ¹⁰	6-cell 15.4W" (WxDxH): 14.1" x 10" x 1.2–1.3"; 357.5mm x 255mm x 30–34mm 6-cell: starting at 5.9 lb (2.7kg); 9-cell: starting at 6.2 lbs (2.8kg) Black <i>Top:</i> Super-Elastic PolyCarbonate (SEPC); <i>Bottom:</i> Carbon-Fiber Reinforced Plastic Lithium Ion 6-cell or 9-cell , supports unique 2nd battery in Ultrabay Slim 6-cell: up to 6.3 hr; 6-cell plus Ultrabay battery: up to 7.8 hr; 9-cell: up to 9.4 hr												
Chipset	Mobile Intel GM45 Express Chipset (Graphics Memory Controller Hub), ICH9M-Enhanced I/O Controller Hub (SATA 3.0Gb/s, USB 2.0, PCI Express® 1.1, PCI 2.3, security chip, ethernet MAC), LPC bus (WPCN385 Super I/O)												
ExpressCard/54 PC Card Smart Card read Multicard reader Ports	One slot (ExpressCard/34, ExpressCard/54) <i>Some:</i> One slot (Type I, Type II), CardBus 32-bit <i>Some:</i> Smart Card reader 7-in-1 reader (MMC, Memory Stick, Mem Stick PRO™, SD, SDHC, XD, XD Type H) Three USB 2.0, external monitor (VGA DB-15, DisplayPort), modem (RJ-11), ethernet (RJ-45), IEEE 1394 FireWire 400 (4-pin connector; 1394a-2000 standard)												
Mini PCI Express Intel 5100 ²⁸ WWAN upg Verizon ¹⁶ AT&T ²³ 2G Turbo UWB Modem Bluetooth™ Ethernet Intel AMT Audio support	Three Mini PCI Express slots 11a/b/g/n wireless ⁴ , Mini PCIe adapter, Intel WiFi Link 5100, 1x2 (Shirley Peak) <i>Some:</i> Wireless WAN upgradable, requires Verizon® (43R9151) or AT&T® (43R9152) <i>Some:</i> Wireless WAN, Qualcomm chipset, Mini PCIe adapter and SIM, EV-DO Rev. A, GPRS/WCDMA/HSPA, GPS, service contract reqd with Verizon <i>Some:</i> Wireless WAN, Ericsson chipset, Mini PCIe adapter and SIM, GPRS/WCDMA/HSPA, GPS, service contract required with AT&T <i>Some:</i> Intel Turbo Memory, Half-Mini PCIe adapter, 2GB flash, disk-cache accelerator None 56K V.92 ⁶ modem <i>Some:</i> Bluetooth 2.0 wireless, LED indicator Intel 82567LM Gigabit Network Connection (Boazman), PHY, PCIe x1 Intel Active Management Technology (IAMT 4.0) High Definition (HD) Audio, Conexant 20561 codec / stereo speakers, 1 watt / volume up, down, mute buttons / digital microphone, microphone input jack, headphone jack												
Security Security chip Fingerprint reader	Power-on password, hard disk password, supervisor password, security keyhole Trusted Platform Module, integrated in ICH9M, TCG 1.2-compliant <i>Some:</i> Fingerprint reader on palm rest, swipe sensor, supports the security chip												
Limited warranty ¹²	3-years/1-yr battery - EasyServ™-19 depot repair service / service upgrades ²² available												
1GB PC3-8500 DDR3 SODIMM 2GB PC3-8500 DDR3 SODIMM 320GB Disk SATA 1.5Gb/s (5400 rpm) Other accessories on O-T500 sheet	43R1987 43R1988 43N3403 T/R/W/SL Series Li-Ion Battery 9-cell 40Y6797 90W Slim AC/DC Combo Adapter 41N8460 ThinkVision® L2440x Wide 24" Monitor 4421HB2 Other accessories at lenovo.com/accessories												
											Preloaded operating system²⁰ - <i>Some:</i> Microsoft® Windows® XP Professional with Vista® COA - <i>Some:</i> Microsoft Windows Vista Business Edition (32-bit) ✦ Vista Premium logo		
											Preloaded applications¹⁴ (all OSes) • Rescue and Recovery™ • Access Connections™ • Client Security Solution™ • ThinkVantage Productivity Center • ThinkVantage System Update • McAfee VirusScan® Plus with SiteAdvisor™ (30 days of virus definitions) • PC-Doctor™ (diagnostics) • ThinkPad Utilities (Power Manager and Presentation Director) • Adobe® Reader • Windows Live™ Toolbar • Windows Live Search • Fingerprint Software (fingerprint models) • Microsoft Office 2007 Trial (60-day) • Roxio® Creator® Business Edition • Roxio MyDVD® (DVD±RW)		
											Supports ThinkVantage® technologies		
											65-watt (GMA graphics) AC adapter ThinkPad Roll Cage and Top Cover Roll Cage (one-piece magnesium) Climate Savers® certified EPEAT™ Gold rating (LED models) EPEAT Silver rating ENERGY STAR® 4.0-compliant RoHS-compliant International Warranty Service ¹⁷ 24 hour x 7 day ¹⁸ toll-free support during the warranty period ¹² via 800-426-7378		
											ThinkPlus™.22 2-year LOR 9x5 NBD 41C9175		
											ThinkPlus 3-year LOR 9x5 NBD 41C9176		
											ThinkPlus 4-year LOR 9x5 NBD 41C9177		
											ThinkPlus 5-year LOR 9x5 NBD 41C9179		
											ThinkPlus 4-year P&L P/U Depot 41C9178		
											ThinkPlus 5-year P&L P/U Depot 41C9180		
											Post-warranty annual maintenance agreements at lenovo.com/thinkplus/warranty		

See footnotes for important warranty information

✦ Intel Centrino® 2 with vPro™ technology

Ⓜ US model announced December 2, 2008; previous models on Aug 5, Sep 23, or October 7, 2008

Type-model	Processor GHz	Memory	Wide-screen display	CCFL or LED	Camera	Switchable graphics	Disk SATA GB ⁵ rpm	SATA optical	Mini PCIe 802.11 wireless	Mini PCIe WWAN	Mini PCIe UWB or Turbo slot	Battery Card	Blue/Global (G)Avail	Workhorse (W) Fing/Preload date	
2055-2BU	T9400	2.53 2GB	15.4" WSXGA+			GMA, 3650 80G	5400 Combo	Intel 5100 ²⁸	WWAN	upg	PC	6 Yes	B32	G Aug 08	
2055-2CU	T9400	2.53 2GB	15.4" WSXGA+			GMA, 3650 160G	5400 DVD±RW	Intel 5100	WWAN	upg	PC	6 Yes	B32 W	G Aug 08	
2055-2EU	T9400	2.53 2GB	15.4" WSXGA+			GMA, 3650 160G	7200 DVD±RW	Intel 5100	Verizon ¹⁶	2G	PC	9 Yes	B32 W	Aug 08	
2055-3AU	T9600	2.80 4GB	15.4" WSXGA+		Cam	GMA, 3650 160G	7200 DVD±RW	Intel 5100	WWAN	upg	2G	PC	9 Yes	B32 W	G Aug 08
2055-45U	T9400	2.53 2GB	15.4" WSXGA+			GMA, 3650 160G	7200 DVD±RW	Intel 5100	WWAN	upg	PC	9 Yes	B32	G Aug 08	
2055-2DU	T9400	2.53 2GB	15.4" WSXGA+		Cam	GMA, 3650 160G	7200 DVD±RW	Intel 5100	WWAN	upg	UWBPC	6 Yes	B32 W	Sep 08	
2055-2VU	T9400	2.53 2GB	15.4" WSXGA+		Cam	GMA, 3650 160G	7200 DVD±RW	Intel 5300 ²⁸	WWAN	upg	UWB	Smart 9	B32	Sep 08	
2055-5TU	T9400	2.53 2GB	15.4" WXGA	LED	Cam	GMA, 3650 160G	7200 DVD±RW	Intel 5300	WWAN	upg	PC	9 Yes	B32 W	G Sep 08	
2055-5UU	T9400	2.53 2GB	15.4" WXGA	LED	Cam	GMA, 3650 64G	SSD DVD±RW	Intel 5300	WWAN	upg	PC	9 Yes	B32	Sep 08	
2055-63U	T9400	2.53 2GB	15.4" WSXGA+			GMA, 3650 160G	7200 DVD±RW	Intel 5100	WWAN	upg	PC	9 Yes	XP	G Sep 08	
2055-7GU	T9400	2.53 2GB	15.4" WSXGA+			GMA, 3650 160G	7200 DVD±RW	Intel 5300	WWAN	upg	Smart 9	9	B32 TAA	Oct 08	
2055-7LU	P8600	2.40 2GB	15.4" WSXGA+			GMA, 3650 160G	7200 DVD±RW	Intel 5100	WWAN	upg	PC	9 Yes	B32 W	G Dec 08	
US Govt (TAA) ⁵ Processor	7GU: US Government model (Trade Act Agreement-compliant) Intel® Core™ 2 Duo processor P8600, T9400, or T9600 with dual-core, Intel HD Boost, 1066MHz system bus; P8600: 3MB L2 cache; T9400/T9600: 6MB L2 cache											Preloaded operating system ²⁰ - Some: Microsoft® Windows® XP Professional with Vista® COA - Some: Microsoft Windows Vista Business Edition (32-bit) ◇ Vista Premium logo			
Memory	2GB or 4GB std / 8GB max ⁷ / PC3-8500 1066MHz DDR3, non-parity, dual-channel capable, two 204-pin SO-DIMM sockets; <i>Italics:</i> standard memory in both sockets; no sockets available; <i>Non-italics:</i> standard memory in one socket; one socket available											Preloaded applications ¹⁴ (all OSes) • Rescue and Recovery™ • Access Connections™ • Client Security Solution™ • ThinkVantage Productivity Center • ThinkVantage System Update • McAfee VirusScan® Plus with SiteAdvisor™ (30 days of virus definitions) • PC-Doctor™ (diagnostics) • ThinkPad Utilities (Power Manager and Presentation Director) • Adobe® Reader • Windows Live™ Toolbar • Windows Live Search • Fingerprint Software (fingerprint models) • Microsoft Office 2007 Trial (60-day) • Roxio® Creator® Business Edition • Roxio MyDVD® (DVD±RW)			
SATA Combo SATA DVD±RW Ultrabay Slim SATA disk	Some: CD-RW/DVD-ROM, SATA 1.5Gb/s, 9.5mm Ultrabay Slim, removable (43N3213) Some: DVD burner, SATA 1.5Gb/s, Ultrabay Slim, removable (43N3214) One modular bay for interchangeable devices (right side), 9.5mm high bay, flat bezel Some: 64GB ⁸ Solid State Drive (SSD) / SATA 3.0Gb/s, 1.8" wide, 8mm high; Some: 80GB ⁸ (5400 rpm), 160GB (5400 or 7200 rpm) / SATA 1.5Gb/s, 2.5" wide, 9.5mm high, Active Protection System™ All: removable, upgradable, supports 2nd disk, shock mounted storage														
Widescreen display	Some: 15.4" (391mm) WXGA (1280x800) color, anti-glare, LED backlight, 190 nits, 16:10 aspect ratio, 300:1 contrast ratio Some: 15.4" (391mm) WSXGA+ (1680x1050) color, anti-glare, CCFL backlight, 200 nits, 16:10 aspect ratio, 500:1 contrast ratio														
Camera	Some: camera on top of screen, 1.3-megapixel, fixed focus														
Switchable graphics	Switches between discrete and integrated graphics (Vista only), Intel Graphics Media Accelerator 4500MHD (GMA 4500MHD), in GM45, and ATI™ Mobility Radeon™ HD 3650, PCI Express x16, 256MB memory, digital monitor support via DisplayPort (supports single-link DVI-D via cable 45J7915); Maximum external resolution: 2048x1536@75Hz (VGA, DisplayPort)														
Keyboard TrackPoint® Touch pad ThinkLight™	89-key, ThinkVantage button, spill-resistant, multimedia Fn keys TrackPoint® pointing device, "Press-to-Select," Internet Scroll Bar ¹³ , magnifying glass UltraNav™, wide touch pad below keyboard, Tap Zones, scrolling regions label Illuminates the keyboard to improve visibility in low-light conditions														
Dimensions ³ Weight ² Case color Case material Battery - type Battery - life ¹⁰	6-cell 15.4W" (WxDxH): 14.1" x 10" x 1.2-1.3"; 357.5mm x 255mm x 30-34mm 6-cell: starting at 5.9 lb (2.7kg); 9-cell: starting at 6.2 lbs (2.8kg) Black Top: Super-Elastic PolyCarbonate (SEPC); Bottom: Carbon-Fiber Reinforced Plastic Lithium Ion 6-cell or 9-cell, supports unique 2nd battery in Ultrabay Slim 6-cell: up to 6.3 hr; 6-cell plus Ultrabay battery: up to 7.8 hr; 9-cell: up to 9.4 hr														
Chipset	Mobile Intel GM45 Express Chipset (Graphics Memory Controller Hub), ICH9M-Enhanced I/O Controller Hub (SATA 3.0Gb/s, USB 2.0, PCI Express® 1.1, PCI 2.3, security chip, ethernet MAC), LPC bus (WPCN385 Super I/O) One slot (ExpressCard/34, ExpressCard/54) Some: One slot (Type I, Type II), CardBus 32-bit Some: Smart Card reader 7-in-1 reader (MMC, Memory Stick, Mem Stick PRO™, SD, SDHC, XD, XD Type H) Three USB 2.0, external monitor (VGA DB-15, DisplayPort), modem (RJ-11), ethernet (RJ-45), IEEE 1394 FireWire 400 (4-pin connector; 1394a-2000 standard)											Supports ThinkVantage® technologies			
ExpressCard/54 PC Card Smart Card read Multicard reader Ports	One slot (ExpressCard/34, ExpressCard/54) Some: One slot (Type I, Type II), CardBus 32-bit Some: Smart Card reader 7-in-1 reader (MMC, Memory Stick, Mem Stick PRO™, SD, SDHC, XD, XD Type H) Three USB 2.0, external monitor (VGA DB-15, DisplayPort), modem (RJ-11), ethernet (RJ-45), IEEE 1394 FireWire 400 (4-pin connector; 1394a-2000 standard)											90-watt (ATI graphics) AC adapter ThinkPad Roll Cage and Top Cover Roll Cage (one-piece magnesium) Climate Savers® certified EPEAT™ Gold rating (LED models) EPEAT Silver rating ENERGY STAR® 4.0-compliant RoHS-compliant International Warranty Service ¹⁷ 24 hour x 7 day ¹⁸ toll-free support during the warranty period ¹² via 800-426-7378			
Mini PCI Express	Three Mini PCI Express slots Some: 11a/b/g/n wireless ⁴ , Mini PCIe adapter, Intel WiFi Link 5100, 1x2 (Shirley Peak) Some: 11a/b/g/n wireless ⁴ , Mini PCIe adapter, Intel WiFi Link 5300, 3x3 (Shirley Peak) Some: Wireless WAN upgradable, requires Verizon® (43R9151) or AT&T® (43R9152) Some: Wireless WAN, Qualcomm chipset, Mini PCIe adapter and SIM, EV-DO Rev. A, GPRS/WCDMA/HSPA, GPS, service contract reqd with Verizon														
2G Turbo UWB Modem Bluetooth™ Ethernet Intel AMT Audio support	Some: Intel Turbo Memory, Half-Mini PCIe adapter, 2GB flash, disk-cache accelerator Some: Wireless USB based on Ultra-Wideband (UWB), Half-Mini PCIe adapter 56K V.92 ⁶ modem Some: Bluetooth 2.0 wireless, LED indicator Intel 82567LM Gigabit Network Connection (Boazman), PHY, PCIe x1 Intel Active Management Technology (IAMT 4.0) High Definition (HD) Audio, Conexant 20561 codec / stereo speakers, 1 watt / volume up, down, mute buttons / digital microphone, microphone input jack, headphone jack														
Security Security chip Fingerprint reader	Power-on password, hard disk password, supervisor password, security keyhole Trusted Platform Module, integrated in ICH9M, TCG 1.2-compliant Some: Fingerprint reader on palm rest, swipe sensor, supports security chip														
Limited warranty ¹²	3-years/1-yr battery - EasyServ™ ¹⁹ depot repair service / service upgrades ²² available														
2GB PC3-8500 DDR3 SODIMM 320GB Disk SATA 1.5Gb/s (5400 rpm) Other accessories on O-T500 sheet	43R1988 43N3403		90W Slim AC/DC Combo Adapter ThinkVision® L2440x Wide 24" Monitor Other accessories at lenovo.com/accessories		41N8460 4421HB2					Post-warranty annual maintenance agreements at lenovo.com/thinkplus/warranty					

See footnotes for important warranty information

◆ Intel Centrino® 2 with vPro™ technology

Ⓜ US model announced December 2, 2008; previous models on Aug 5, Sep 23, or October 7, 2008

Type-model	Proc- essor GHz	Memory	Wide- screen display	CCFL or LED	Cam- era	Integrated graphics	Disk SATA GB ⁸ rpm	SATA optical	Mini PCIe 802.11 wireless	Mini PCIe WWAN	Mini PCIe UWB or Turbo	Bat- tery Blue- tooth	Whorse (W) GMP (P) Avail Preload Gbl (G) date
2241-3WUP	P8400	2.26 1GB	15.4" WXGA			GMA 80G	5400 Combo	Intel 5100 ²⁸	WWAN upg		6	Blue Bus 32	GP Aug 08
2241-3XU	T9400	2.53 2GB	15.4" WXGA		Cam	GMA 160G	5400 DVD±RW	Intel 5100	WWAN upg	2G Turbo	6	Blue Bus 32	WGP Aug 08
2241-3YU	T9400	2.53 2GB	15.4" WXGA		Cam	GMA 160G	5400 DVD±RW	Intel 5100	WWAN upg		6	Blue Bus 32	GP Aug 08
2241-4XU	T9400	2.53 2GB	15.4" WXGA	LED	Cam	GMA 160G	5400 DVD±RW	Intel 5100	WWAN upg		6	Blue Bus 32	WGP Sep 08
2241-58U	T9400	2.53 2GB	15.4" WXGA			GMA 160G	5400 DVD±RW	Intel 5100	WWAN upg		6	Blue XP Pro	GP Sep 08
2241-5ZU	P8600	2.40 2GB	15.4" WXGA	LED		GMA 160G	5400 DVD±RW	Intel 5100	WWAN upg		6	Blue Bus 32	WGP Dec 08
<p>• These models are part of the Global Models Plus program with limited onsite service²⁴ 3-year limited warranty</p>													
Positioning Processor	<p>Premiere performance; two spindles Intel® Core™ 2 Duo processor P8400, P8600, or T9400 with dual-core, Intel HD Boost, 1066MHz system bus; P8400/P8600: 3MB L2 cache; T9400: 6MB L2 cache</p>											<p>Preloaded operating system²⁰ - Some: Microsoft® Windows® XP Professional with Vista® COA - Some: Microsoft Windows Vista Business Edition (32-bit) ♦ Vista Premium logo</p>	
Memory	<p>1GB or 2GB std / 8GB max⁷ / PC3-8500 1066MHz DDR3, non-parity, dual-channel capable, two 204-pin SO-DIMM sockets; <i>Italics:</i> standard memory in both sockets; no sockets available; <i>Non-italics:</i> standard memory in one socket; one socket available</p>											<p>Preloaded applications¹⁴ (all OSes) • Rescue and Recovery™ • Access Connections™ • Client Security Solution™ • ThinkVantage Productivity Center • ThinkVantage System Update • McAfee VirusScan® Plus with SiteAdvisor™ (30 days of virus definitions) • PC-Doctor™ (diagnostics) • ThinkPad Utilities (Power Manager and Presentation Director) • Adobe® Reader • Windows Live™ Toolbar • Windows Live Search • Fingerprint Software (fingerprint models) • Microsoft Office 2007 Trial (60-day) • Roxio® Creator® Business Edition • Roxio MyDVD® (DVD±RW)</p>	
SATA Combo SATA DVD±RW Ultrabay Slim SATA disk	<p><i>Some:</i> CD-RW/DVD-ROM, SATA 1.5Gb/s, 9.5mm Ultrabay Slim, removable (43N3213) <i>Some:</i> DVD burner, SATA 1.5Gb/s, Ultrabay Slim, removable (43N3214) One modular bay for interchangeable devices (right side), 9.5mm high bay, flat bezel 80GB⁸ (5400 rpm), 160GB⁸ (5400 rpm) / SATA 1.5Gb/s, 2.5" wide, 9.5mm high, removable, upgradable, supports 2nd disk, ThinkPad Shock Mounted Hard Drive, Active Protection System™</p>												
Widescreen display	<p><i>Some:</i> 15.4" (391mm) WXGA (1280x800) color, anti-glare, CCFL backlight, 200 nits, 16:10 aspect ratio, 300:1 contrast ratio <i>Some:</i> 15.4" (391mm) WXGA (1280x800) color, anti-glare, LED backlight, 190 nits, 16:10 aspect ratio, 300:1 contrast ratio</p>												
Camera	<p><i>Some:</i> camera on top of screen, 1.3-megapixel, fixed focus</p>												
Integrated graphics	<p>Intel Graphics Media Accelerator 4500MHD (GMA 4500MHD), in GM45, digital monitor support via DisplayPort (supports single-link DVI-D via cable 45J7915); <i>Maximum external resolution:</i> 2048x1536@75Hz</p>												
Keyboard TrackPoint® Touch pad ThinkLight™	<p>89-key, ThinkVantage button, spill-resistant, multimedia Fn keys TrackPoint® pointing device, "Press-to-Select," Internet Scroll Bar¹³, magnifying glass UltraNav™, wide touch pad below keyboard, Tap Zones, scrolling regions label Illuminates the keyboard to improve visibility in low-light conditions</p>												
Dimensions ³ Weight ² Case color Case material Battery - type Battery - life ¹⁰	<p><i>6-cell 15.4W" (WxDxH):</i> 14.1" x 10" x 1.2–1.3"; 357.5mm x 255mm x 30–34mm <i>6-cell:</i> starting at 5.9 lb (2.7kg) Black Top: Super-Elastic PolyCarbonate (SEPC); Bottom: Carbon-Fiber Reinforced Plastic Lithium Ion 6-cell, supports unique 2nd battery in Ultrabay Slim <i>6-cell:</i> up to 6.3 hr; <i>6-cell plus Ultrabay battery:</i> up to 7.8 hr; <i>9-cell:</i> up to 9.4 hr</p>												
Chipset	<p>Mobile Intel GM45 Express Chipset (Graphics Memory Controller Hub), ICH9M-Enhanced I/O Controller Hub (SATA 3.0Gb/s, USB 2.0, PCI Express® 1.1, PCI 2.3, security chip, ethernet MAC), LPC bus (WPCN385 Super I/O)</p>												
ExpressCard/54 PC Card Smart Card read Multicard reader Ports	<p>One slot (ExpressCard/34, ExpressCard/54) One slot (Type I, Type II), CardBus 32-bit None 7-in-1 reader (MMC, Memory Stick, Mem Stick PRO™, SD, SDHC, XD, XD Type H) Three USB 2.0, external monitor (VGA DB-15), modem (RJ-11), ethernet (RJ-45), IEEE 1394 FireWire 400 (4-pin connector; 1394a-2000 standard)</p>												
Mini PCI Express Intel 5100 ²⁸ WWAN upg 2G Turbo UWB Modem Bluetooth™ Ethernet Intel AMT Audio support	<p>Three Mini PCI Express slots 11a/b/g/n wireless⁸, Mini PCIe adapter, Intel WiFi Link 5100, 1x2 (Shirley Peak) Wireless WAN upgradable, requires Verizon® (43R9151) or AT&T® (43R9152) <i>Some:</i> Intel Turbo Memory, Half-Mini PCIe adapter, 2GB flash, disk-cache accelerator None 56K V.92⁶ modem Bluetooth 2.0 wireless, LED indicator Intel 82567LM Gigabit Network Connection (Boazman), PHY, PCIe x1 Intel Active Management Technology (IAMT 4.0) High Definition (HD) Audio, Conexant 20561 codec / stereo speakers, 1 watt / volume up, down, mute buttons / digital microphone, microphone input jack, headphone jack</p>											<p>Supports ThinkVantage® technologies</p>	
Security Security chip Fingerprint reader	<p>Power-on password, hard disk password, supervisor password, security keyhole Trusted Platform Module, integrated in ICH9M, TCG 1.2-compliant Fingerprint reader on palm rest, swipe sensor, supports the security chip</p>											<p>65-watt (GMA graphics) AC adapter ThinkPad Roll Cage and Top Cover Roll Cage (one-piece magnesium) Climate Savers® certified EPEAT™ Gold rating (LED models) EPEAT Silver rating ENERGY STAR® 4.0-compliant RoHS-compliant International Warranty Service¹⁷ 24 hour x 7 day¹⁸ toll-free support during the warranty period¹² via 800-426-7378</p>	
Limited warranty ¹²	<p>3-years/1-year battery, limited onsite service²⁴, 8 am - 5 pm, Mon - Fri coverage excluding holidays, next business day response time / service upgrades²² available</p>												
1GB PC3-8500 DDR3 SODIMM 2GB PC3-8500 DDR3 SODIMM 128GB SSD SATA 3.0Gb/s 1.8" (2.5" cover) 320GB Disk SATA 1.5Gb/s (5400 rpm) USB 2.0 Portable Secure 320GB Hard Disk USB 2.0 Super Multi-Burner Drive ThinkPad Advanced Dock Verizon WWAN UNDP Broadband AT&T WWAN HSPA Broadband Mini PCIe Laser Tilt Wheel Travel Mouse (Bluetooth) Other accessories on O-T500 sheet	43R1987 43R1988 43N3406 43N3403 43R2019 41N5565 250310U 43R9151 43R9152 41U5008	T/R/W/SL Series Li-Ion Battery 6-cell T/R/W/SL Series Li-Ion Battery 9-cell Advanced Ultrabay Battery II 3-cell 90W Slim AC/DC Combo Adapter ThinkPad Business Topload Case ThinkPad Business Backpack DisplayPort to Single-link DVI-D Cable T500/R500/W500 15W Privacy Filter ThinkVision® L2240p Wide 22" Monitor ThinkVision L2440x Wide 24" Monitor Other accessories at lenovo.com/accessories	40Y6799 40Y6797 43R9250 41N8460 43R2476 43R2482 45J7915 43R2474 4422HB6 4421HB2										
<p>See footnotes for important warranty information</p>											<p>ThinkPlus™²² 4-year LOR 9x5 NBD 12X5630 Post-warranty annual maintenance agreements at lenovo.com/thinkplus/warranty</p>		

See footnotes for important warranty information

♦ Intel Centrino® 2 with vPro™ technology

© Lenovo

US model announced December 2, 2008; previous models on August 5 or September 23, 2008

(CR5-5) December 2008

ThinkPad® T500 2056 (Switchable) - Onsite

Personal Systems Reference (PSREF)

Type-model	Proc- essor	Mem- ory	Wide- screen display	CCFL or Cam- era	Switchable graphics	Disk SATA GB ⁵ rpm	SATA optical	Mini PCIe 802.11 wireless	Mini PCIe WWAN	Mini PCIe UWB or Turbo	Bat- tery Preload	Whorse (W) GMP (P) Avail Gbl (G) date
2056-4PU	T9400	2.53 2GB	15.4" WSXGA+		GMA, 3650	80G 5400 Combo		Intel 5100 ²⁸	WWAN upg		6 B32	GP Aug 08
2056-4QU	T9400	2.53 2GB	15.4" WSXGA+		GMA, 3650	160G 5400 DVD±RW		Intel 5100	WWAN upg		6 B32	WGP Aug 08
2056-4RU	T9400	2.53 2GB	15.4" WSXGA+		GMA, 3650	160G 7200 DVD±RW		Intel 5100	WWAN upg		9 B32	GP Aug 08
2056-4SU	T9600	2.80 4GB	15.4" WSXGA+	Cam	GMA, 3650	160G 7200 DVD±RW		Intel 5100	WWAN upg	2G Turbo	9 B32	WGP Aug 08
2056-5TU	T9400	2.53 2GB	15.4" WSXGA	LED Cam	GMA, 3650	160G 7200 DVD±RW		Intel 5300 ²⁸	WWAN upg		9 B32	WGP Sep 08
2056-63U	T9400	2.53 2GB	15.4" WSXGA+		GMA, 3650	160G 7200 DVD±RW		Intel 5100	WWAN upg		9 XP	GP Sep 08
2056-7LU	P8600	2.40 2GB	15.4" WSXGA+		GMA, 3650	160G 7200 DVD±RW		Intel 5100	WWAN upg		9 B32	WGP Dec 08
<p>• These models are part of the Global Models Plus program with limited onsite service²⁴ 3-year limited warranty</p>												
Processor	Intel® Core™ 2 Duo processor P8600, T9400, or T9600 with dual-core, Intel HD Boost, 1066MHz system bus; P8600: 3MB L2 cache; T9400/T9600: 6MB L2 cache										Preloaded operating system ²⁰	
Memory	2GB or 4GB std / 8GB max ⁷ / PC3-8500 1066MHz DDR3, non-parity, dual-channel capable, two 204-pin SO-DIMM sockets; <i>Italics:</i> standard memory in both sockets; no sockets available; <i>Non-italics:</i> standard memory in one socket; one socket available										- Some: Microsoft® Windows® XP Professional with Vista® COA - Some: Microsoft Windows Vista Business Edition (32-bit) ◇ Vista Premium logo	
SATA Combo SATA DVD±RW Ultrabay Slim SATA disk	Some: CD-RW/DVD-ROM, SATA 1.5Gb/s, 9.5mm Ultrabay Slim, removable (43N3213) Some: DVD burner, SATA 1.5Gb/s, Ultrabay Slim, removable (43N3214) One modular bay for interchangeable devices (right side), 9.5mm high bay, flat bezel 80GB ⁸ (5400 rpm), 160GB (5400 or 7200 rpm) / SATA 1.5Gb/s, 2.5" wide, 9.5mm high, removable, upgradable, supports 2nd disk, ThinkPad Shock Mounted Hard Drive, Active Protection System™										Preloaded applications ¹⁴ (all OSes)	
Widescreen display	Some: 15.4" (391mm) WXGA (1280x800) color, anti-glare, LED backlight, 190 nits, 16:10 aspect ratio, 300:1 contrast ratio Some: 15.4" (391mm) WSXGA+ (1680x1050) color, anti-glare, CCFL backlight, 200 nits, 16:10 aspect ratio, 500:1 contrast ratio										• Rescue and Recovery™ • Access Connections™ • Client Security Solution™ • ThinkVantage Productivity Center • ThinkVantage System Update • McAfee VirusScan® Plus with SiteAdvisor™ (30 days of virus definitions) • PC-Doctor™ (diagnostics) • ThinkPad Utilities (Power Manager and Presentation Director) • Adobe® Reader • Windows Live™ Toolbar • Windows Live Search • Fingerprint Software (fingerprint models)	
Camera	Some: camera on top of screen, 1.3-megapixel, fixed focus										• Microsoft Office 2007 Trial (60-day) • Roxio® Creator® Business Edition • Roxio MyDVD® (DVD±RW)	
Switchable graphics	Dynamic switching between discrete and integrated graphics (user selectable), Intel Graphics Media Accelerator 4500MHD (GMA 4500MHD), in GM45, and ATI™ Mobility Radeon™ HD 3650, PCI Express x16, 256MB memory, digital monitor support via DisplayPort (supports single-link DVI-D via cable 45J7915); Maximum external resolution: 2048x1536@75Hz											
Keyboard TrackPoint® Touch pad ThinkLight™	89-key, ThinkVantage button, spill-resistant, multimedia Fn keys TrackPoint® pointing device, "Press-to-Select," Internet Scroll Bar ¹³ , magnifying glass UltraNav™, wide touch pad below keyboard, Tap Zones, scrolling regions label Illuminates the keyboard to improve visibility in low-light conditions											
Dimensions ³ Weight ² Case color Case material Battery - type Battery - life ¹⁰	6-cell 15.4W" (WxDxH): 14.1" x 10" x 1.2-1.3"; 357.5mm x 255mm x 30-34mm 6-cell: starting at 5.9 lb (2.7kg); 9-cell: starting at 6.2 lbs (2.8kg) Black Top: Super-Elastic PolyCarbonate (SEPC); Bottom: Carbon-Fiber Reinforced Plastic Lithium Ion 6-cell or 9-cell, supports unique 2nd battery in Ultrabay Slim 6-cell: up to 6.3 hr; 6-cell plus Ultrabay battery: up to 7.8 hr; 9-cell: up to 9.4 hr											
Chipset	Mobile Intel GM45 Express Chipset (Graphics Memory Controller Hub), ICH9M-Enhanced I/O Controller Hub (SATA 3.0Gb/s, USB 2.0, PCI Express® 1.1, PCI 2.3, security chip, ethernet MAC), LPC bus (WPCN385 Super I/O)											
ExpressCard/54 PC Card Smart Card read Multicard reader Ports	One slot (ExpressCard/34, ExpressCard/54) One slot (Type I, Type II), CardBus 32-bit None 7-in-1 reader (MMC, Memory Stick, Mem Stick PRO™, SD, SDHC, XD, XD Type H) Three USB 2.0, external monitor (VGA DB-15, DisplayPort), modem (RJ-11), ethernet (RJ-45), IEEE 1394 FireWire 400 (4-pin connector; 1394a-2000 standard)											
Mini PCI Express	Three Mini PCI Express slots Some: 11a/b/g/n wireless ⁴ , Mini PCIe adapter, Intel WiFi Link 5100, 1x2 (Shirley Peak) Some: 11a/b/g/n wireless ⁴ , Mini PCIe adapter, Intel WiFi Link 5300, 3x3 (Shirley Peak) Wireless WAN upgradable, requires Verizon® (43R9151) or AT&T® (43R9152) Some: Intel Turbo Memory, Half-Mini PCIe adapter, 2GB flash, disk-cache accelerator											
Modem Bluetooth™ Ethernet Intel AMT Audio support	56K V.92 ⁶ modem Bluetooth 2.0 wireless, LED indicator Intel 82567LM Gigabit Network Connection (Boazman), PHY, PCIe x1 Intel Active Management Technology (IAMT 4.0) High Definition (HD) Audio, Conexant 20561 codec / stereo speakers, 1 watt / volume up, down, mute buttons / digital microphone, microphone input jack, headphone jack										Supports ThinkVantage® technologies	
Security Security chip Fingerprint reader	Power-on password, hard disk password, supervisor password, security keyhole Trusted Platform Module, integrated in ICH9M, TCG 1.2-compliant Fingerprint reader on palm rest, swipe sensor, supports the security chip										90-watt (ATI graphics) AC adapter ThinkPad Roll Cage and Top Cover Roll Cage (one-piece magnesium) Climate Savers® certified EPEAT™ Gold rating (LED models) EPEAT Silver rating ENERGY STAR® 4.0-compliant RoHS-compliant International Warranty Service ¹⁷ 24 hour x 7 day ¹⁸ toll-free support during the warranty period ¹² via 800-426-7378	
Limited warranty ¹²	3-years/1-year battery, limited onsite service ²⁴ , 8 am - 5 pm, Mon - Fri coverage excluding holidays, next business day response time / service upgrades ²² available											
1GB PC3-8500 DDR3 SODIMM 2GB PC3-8500 DDR3 SODIMM 128GB SSD SATA 3.0Gb/s 1.8" (2.5" cover) 320GB Disk SATA 1.5Gb/s (5400 rpm) USB 2.0 Portable Secure 320GB Hard Disk ThinkPad Advanced Dock Verizon WWAN UNDP Broadband AT&T WWAN HSPA Broadband Mini PCIe Other accessories on O-T500 sheet	43R1987 43R1988 43N3406 43N3403 43R2019 250310U 43R9151 43R9152		T/R/W/SL Series Li-Ion Battery 9-cell Advanced Ultrabay Battery II 3-cell 90W Slim AC/DC Combo Adapter ThinkPad Business Topload Case T500/R500/W500 15W Privacy Filter ThinkVision® L1940p Wide 19" Monitor ThinkVision L2240p Wide 22" Monitor ThinkVision L2440x Wide 24" Monitor Other accessories at lenovo.com/accessories		40Y6797 43R9250 41N8460 43R2476 43R2474 4424HB6 4422HB6 4421HB2						ThinkPlus™.22 4-year LOR 9x5 NBD 12X5630 Post-warranty annual maintenance agreements at lenovo.com/thinkplus/warranty	

See footnotes for important warranty information

◆ Intel Centrino® 2 with vPro™ technology

© Lenovo

Ⓜ US model announced December 2, 2008; previous models on August 5 or September 23, 2008

(CR5-6) December 2008

ThinkPad® T500 2089 (GMA) - Education (EasyServ)

Personal Systems Reference (PSREF)

Type-model	Proc- essor GHz	Memory	Wide- screen display	CCFL or LED	Cam- era	Integrated graphics	Disk SATA GB ⁵ rpm	SATA optical	Mini PCIe 802.11 wireless	Mini PCIe WWAN	Mini PCIe Bat- tery UWB or Turbo	Blue- tooth cells	Workhorse (W) Global (G) Avail Preload date
2089-E1U	P8400	2.26 2GB	15.4" WXGA		Cam	GMA 160G	5400	DVD±RW	Intel 5100 ²⁸	WWAN upg	None	6 Blue	Bus 32 No Aug 08
2089-E2U	T9400	2.53 2GB	15.4" WXGA		Cam	GMA 250G	5400	DVD±RW	Intel 5100	WWAN upg	None	6 Blue	Bus 32 No Aug 08
2089-E3U	T9400	2.53 2GB	15.4" WXGA		Cam	GMA 160G	7200	DVD±RW	Intel 5100	WWAN upg	None	9 Blue	Bus 32 No Aug 08
2089-E4U	P8600	2.40 2GB	15.4" WXGA	LED	Cam	GMA 160G	7200	DVD±RW	Intel 5100	WWAN upg	None	6 Blue	Bus 32 No Dec 08

• **These models have an EasyServ™, 19 depot repair service 3-year limited warranty**
 These educational models are available only to public or private K-12 or higher accredited schools organized and operated exclusively for educational purposes for use by qualified students and teachers.

Positioning Processor	<i>Premiere performance; two spindles</i> Intel® Core™ 2 Duo processor P8400, P8600, or T9400 with dual-core , Intel HD Boost, 1066MHz system bus; <i>P8400/P8600</i> : 3MB L2 cache; <i>T9400</i> : 6MB L2 cache	Preloaded operating system²⁰ - Microsoft® Windows® Vista® Business Edition (32-bit) ⇨ Vista Premium logo Preloaded applications¹⁴ • Education software - Microsoft Office OneNote® 2007 (and CD) - VitalSource Library College Edition - Adobe® Instructor Resource Cntr - Adobe Digital School Collection - Photoshop Elements (and CD) - Premier Elements (and DVD) - Acrobat 8 Professional - Contribute 4 • Rescue and Recovery™ • Access Connections™ • Client Security Solution™ • ThinkVantage Productivity Center • ThinkVantage System Update • McAfee VirusScan® Plus with SiteAdvisor™ (30 days of virus definitions) • PC-Doctor™ (diagnostics) • ThinkPad Utilities (Power Manager and Presentation Director) • Adobe® Reader • Windows Live™ Toolbar • Windows Live Search • Fingerprint Software (fingerprint models) • Microsoft Office 2007 Trial (60-day) • Roxio® Creator® Business Edition • Roxio MyDVD® (DVD±RW)
Memory	2GB std / 8GB max ⁷ / PC3-8500 1066MHz DDR3 , non-parity, dual-channel capable, two 204-pin SO-DIMM sockets; <i>Italics:</i> standard memory in both sockets; no sockets available <i>Non-italics:</i> standard memory in one socket; one socket available	
SATA DVD±RW Ultrabay Slim SATA disk	<i>Some:</i> DVD burner, SATA 1.5Gb/s, Ultrabay Slim, removable (43N3214) One modular bay for interchangeable devices (right side), 9.5mm high bay, flat bezel 160GB⁸ (5400 or 7200 rpm), or 250GB (5400 rpm) / SATA 1.5Gb/s, 2.5" wide, 9.5mm high, removable, upgradable, supports 2nd disk, ThinkPad Shock Mounted Hard Drive, Active Protection System™	
Widescreen display	<i>Some:</i> 15.4" (391mm) WXGA (1280x800) color , anti-glare, CCFL backlight, 200 nits, 16:10 aspect ratio, 300:1 contrast ratio <i>Some:</i> 15.4" (391mm) WXGA (1280x800) color , anti-glare, LED backlight , 190 nits, 16:10 aspect ratio, 300:1 contrast ratio	
Camera	Camera on top of screen, 1.3-megapixel, fixed focus	
Integrated graphics	Intel Graphics Media Accelerator 4500MHD (GMA 4500MHD) , in GM45, digital monitor support via DisplayPort (supports single-link DVI-D via cable 45J7915); <i>Maximum external resolution: 2048x1536@75Hz</i>	
Keyboard TrackPoint® Touch pad ThinkLight™	89-key, ThinkVantage button, spill-resistant, multimedia Fn keys TrackPoint® pointing device, "Press-to-Select," Internet Scroll Bar ¹³ , magnifying glass UltraNav™, wide touch pad below keyboard, Tap Zones, scrolling regions label Illuminates the keyboard to improve visibility in low-light conditions	
Dimensions ³ Weight ² Case color Case material Battery - type Battery - life ¹⁰	<i>6-cell 15.4W"</i> (WxDxH): 14.1" x 10" x 1.2-1.3"; 357.5mm x 255mm x 30-34mm <i>6-cell:</i> starting at 5.9 lb (2.7kg); <i>9-cell:</i> starting at 6.2 lbs (2.8kg) Black <i>Top:</i> Super-Elastic PolyCarbonate (SEPC); <i>Bottom:</i> Carbon-Fiber Reinforced Plastic Lithium Ion 6-cell or 9-cell , supports unique 2nd battery in Ultrabay Slim <i>6-cell:</i> up to 6.3 hr; <i>6-cell plus Ultrabay battery:</i> up to 7.8 hr; <i>9-cell:</i> up to 9.4 hr	
Chipset	Mobile Intel GM45 Express Chipset (Graphics Memory Controller Hub), ICH9M-Enhanced I/O Controller Hub (SATA 3.0Gb/s, USB 2.0, PCI Express® 1.1, PCI 2.3, security chip, ethernet MAC), LPC bus (WPCN385 Super I/O)	
ExpressCard/54 PC Card Smart Card read Multicard reader Ports	One slot (ExpressCard/34, ExpressCard/54) One slot (Type I, Type II), CardBus 32-bit None 7-in-1 reader (MMC, Memory Stick, Mem Stick PRO™, SD, SDHC, XD, XD Type H) Three USB 2.0, external monitor (VGA DB-15, DisplayPort), modem (RJ-11), ethernet (RJ-45), IEEE 1394 FireWire 400 (4-pin connector; 1394a-2000 standard)	
Mini PCI Express Intel 5100 ²⁸ WWAN upg 2G Turbo UWB Modem Bluetooth™ Ethernet Intel AMT Audio support Security Security chip Fingerprint reader	Three Mini PCI Express slots 11a/b/g/n wireless ⁴ , Mini PCIe adapter, Intel WiFi Link 5100, 1x2 (Shirley Peak) Wireless WAN upgradable, requires Verizon® (43R9151) or AT&T® (43R9152) None None 56K V.92 ⁶ modem Bluetooth 2.0 wireless, LED indicator Intel 82567LM Gigabit Network Connection (Boazman), PHY, PCIe x1 Intel Active Management Technology (IAMT 4.0) High Definition (HD) Audio, Conexant 20561 codec / stereo speakers, 1 watt / volume up, down, mute buttons / digital microphone, microphone input jack, headphone jack Power-on password, hard disk password, supervisor password, security keyhole Trusted Platform Module, integrated in ICH9M, TCG 1.2-compliant Fingerprint reader on palm rest, swipe sensor, supports the security chip	
Limited warranty ¹²	3-years/1-yr battery - EasyServ™, 19 depot repair service / service upgrades²² available	
1GB PC3-8500 DDR3 SODIMM 2GB PC3-8500 DDR3 SODIMM Blu-ray Burner Ultrabay Slim Serial ATA Hard Drive Bay Adapter II 128GB SSD SATA 3.0Gb/s 1.8" (2.5" cover) 320GB Disk SATA 1.5Gb/s (5400 rpm) USB 2.0 Portable Secure 320GB Hard Disk USB 2.0 Super Multi-Burner Drive ThinkPad Advanced Dock Verizon WWAN UNDP Broadband AT&T WWAN HSPA Broadband Mini PCIe Other accessories on O-T500 sheet	43R1987 43R1988 43N3215 43R1980 43N3406 43N3403 43R2019 41N5565 250310U 43R9151 43R9152	
T/R/W/SL Series Li-Ion Battery 6-cell T/R/W/SL Series Li-Ion Battery 9-cell Advanced Ultrabay Battery II 3-cell ThinkPad 90W AC Adapter 90W Slim AC/DC Combo Adapter ThinkPad Business Topload Case ThinkPad Business Backpack T500/R500/W500 15W Privacy Filter ThinkVision® L1940p Wide 19" Monitor ThinkVision L2240p Wide 22" Monitor ThinkVision L2440x Wide 24" Monitor Other accessories at lenovo.com/accessories	40Y6799 40Y6797 43R9250 40Y7659 41N8460 43R2476 43R2482 43R2474 4424HB6 4422HB6 4421HB2	
ThinkPlus™, 22 2-year LOR 9x5 NBD 41C9175 ThinkPlus 3-year LOR 9x5 NBD 41C9176 ThinkPlus 4-year LOR 9x5 NBD 41C9177 ThinkPlus 5-year LOR 9x5 NBD 41C9179 ThinkPlus 4-year P&L P/U Depot 41C9178 ThinkPlus 5-year P&L P/U Depot 41C9180 Post-warranty annual maintenance agreements at lenovo.com/thinkplus/warranty		

See footnotes for important warranty information

✦ Intel Centrino® 2 with vPro™ technology

© Lenovo

US model announced December 2, 2008; previous models on August 5, 2008

(CR5-7) December 2008

ThinkPad® T500 2055 (Switchable) - Education (EasyServ)

Personal Systems Reference (PSREF)

Type-model	Processor	GHz	Memory	Wide-screen display	Camera	Switchable graphics	Disk SATA GB ⁸ rpm	SATA optical	Mini PCIe 802.11 wireless	Mini PCIe WWAN	Mini PCIe UWB or Turbo cells	Battery	Workhorse (W) Global (G) Avail date
2055-E1U	T9400	2.53	2GB	15.4" WSXGA+	Cam GMA, HD	3650	160G 7200	DVD±RW	Intel 5100	WWAN upg	None	9	Bus32 No Aug 08
2055-E2U	T9400	2.53	2GB	15.4" WSXGA+	Cam GMA, HD	3650	250G 5400	DVD±RW	Intel 5100	WWAN upg	None	9	Bus32 No Aug 08

• **These models have an EasyServ™¹⁹ depot repair service 3-year limited warranty**

Educational models are available only to public or private K-12 or higher accredited schools organized and operated exclusively for educational purposes for use by qualified students and teachers.

Positioning Processor	<i>Premiere performance; two spindles</i> Intel® Core™ 2 Duo processor T9400 with dual-core, Intel HD Boost, 1066MHz system bus, and 6MB L2 cache										Preloaded operating system²⁰ - Microsoft® Windows® Vista® Business Edition (32-bit) - Vista Premium logo		
Memory	2GB std / 8GB max ⁷ / PC3-8500 1066MHz DDR3 , non-parity, dual-channel capable, two 204-pin SO-DIMM sockets; <i>Non-italics:</i> standard memory in one socket; one socket available										Preloaded applications¹⁴ • Education software - Microsoft Office OneNote® 2007 (and CD) - VitalSource Library College Edition - Adobe® Instructor Resource Cntr – Photoshop Elements (and CD) - Premier Elements (and DVD) - Acrobat 8 Professional - Contribute 4 • Rescue and Recovery™ • Access Connections™ • Client Security Solution™ • ThinkVantage Productivity Center • ThinkVantage System Update • McAfee VirusScan® Plus with SiteAdvisor™ (30 days of virus definitions) • PC-Doctor™ (diagnostics) • ThinkPad Utilities (Power Manager and Presentation Director) • Adobe® Reader • Windows Live™ Toolbar • Windows Live Search • Fingerprint Software (fingerprint models) • Microsoft Office 2007 Trial (60-day) • Roxio® Creator® Business Edition • Roxio MyDVD® (DVD±RW)		
SATA DVD±RW Ultrabay Slim SATA disk	<i>Some:</i> DVD burner, SATA 1.5Gb/s, Ultrabay Slim, removable (43N3214) One modular bay for interchangeable devices (right side), 9.5mm high bay, flat bezel 160GB⁸ (7200 rpm) or 250GB (5400 rpm) / SATA 1.5Gb/s, 2.5" wide, 9.5mm high, removable, upgradable, supports 2nd disk, ThinkPad Shock Mounted Hard Drive, Active Protection System™												
Widescreen display	15.4" (391mm) WSXGA+ (1680x1050) color , anti-glare, CCFL backlight, 200 nits, 16:10 aspect ratio, 500:1 contrast ratio												
Camera	<i>Some:</i> camera on top of screen, 1.3-megapixel, fixed focus												
Switchable graphics	Switches between discrete and integrated graphics (Vista only), Intel Graphics Media Accelerator 4500MHD (GMA 4500MHD) , in GM45, and ATI™ Mobility Radeon™ HD 3650 , PCI Express x16, 256MB memory, digital monitor support via DisplayPort (supports single-link DVI-D via cable 45J7915); <i>Maximum external resolution:</i> 2048x1536@75Hz												
Keyboard	89-key, ThinkVantage button, spill-resistant, multimedia Fn keys												
TrackPoint®	TrackPoint® pointing device, "Press-to-Select," Internet Scroll Bar ¹³ , magnifying glass												
Touch pad	UltraNav™, wide touch pad below keyboard, Tap Zones, scrolling regions label												
ThinkLight™	Illuminates the keyboard to improve visibility in low-light conditions												
Dimensions ³	<i>6-cell 15.4W" (WxDxH):</i> 14.1" x 10" x 1.2–1.3"; 357.5mm x 255mm x 30–34mm												
Weight ²	<i>9-cell:</i> starting at 6.2 lb (2.8kg)												
Case material	<i>Top:</i> Super-Elastic PolyCarbonate (SEPC); <i>Bottom:</i> Carbon-Fiber Reinforced Plastic												
Battery - type	Lithium Ion 9-cell , supports unique 2nd battery in Ultrabay Slim												
Battery - life ¹⁰	<i>9-cell:</i> up to 9.4 hr; <i>9-cell plus Ultrabay battery:</i> up to 10.9 hr												
Chipset	Mobile Intel GM45 Express Chipset (Graphics Memory Controller Hub), ICH9M-Enhanced I/O Controller Hub (SATA 3.0Gb/s, USB 2.0, PCI Express® 1.1, PCI 2.3, security chip, ethernet MAC), LPC bus (WPCN385 Super I/O)												
ExpressCard slot	One ExpressCard/34 or ExpressCard/54												
PC Card Std slot	One Type I or Type II slot, CardBus 32-bit												
Smart Card Read	None												
Multicard Reader	7-in-1 reader (MMC, Memory Stick, Mem Stick Pro, SD, SDHC, XD, XD Type H)												
Ports	Three USB 2.0, external monitor (VGA DB-15, DisplayPort), modem (RJ-11), ethernet (RJ-45), IEEE 1394 FireWire 400 (4-pin connector; 1394a-2000 standard)												
Mini PCI Express Intel 5100 ²⁸	Three Mini PCI Express slots										Supports ThinkVantage® technologies		
WWAN upg	11a/b/g/n wireless ⁴ , Mini PCIe adapter, Intel WiFi Link 5100, 1x2 (Shirley Peak)												
2G Turbo	Wireless WAN upgradable, requires Verizon® (43R9151) or AT&T® (43R9152)												
UWB	None												
Modem	56K V.92 ⁶ modem												
Bluetooth™	Bluetooth 2.0 wireless, LED indicator												
Ethernet	Intel 82567LM Gigabit Network Connection (Boazman), PHY, PCIe x1												
Intel AMT	Intel Active Management Technology (IAMT 4.0)												
Audio support	High Definition (HD) Audio, Conexant 20561 codec / stereo speakers, 1 watt / volume up, down, mute buttons / digital microphone, microphone input jack, headphone jack												
Security	Power-on password, hard disk password, supervisor password, security keyhole												
Security chip	Trusted Platform Module, integrated in ICH9M, TCG 1.2-compliant												
Fingerprint reader	Fingerprint reader on palm rest, swipe sensor, supports the security chip												
Limited warranty ¹²	3-years/1-yr battery - EasyServ™¹⁹ depot repair service / service upgrades²² available										ThinkPlus™. ²² 2-year LOR 9x5 NBD 41C9175		
1GB PC3-8500 DDR3 SODIMM	43R1987				T/R/W/SL Series Li-Ion Battery 6-cell				40Y6799				
2GB PC3-8500 DDR3 SODIMM	43R1988				T/R/W/SL Series Li-Ion Battery 9-cell				40Y6797				
Blu-ray Burner Ultrabay Slim SATA 1.5Gb/s	43N3215				Advanced Ultrabay Battery II 3-cell				43R9250				
Serial ATA Hard Drive Bay Adapter II SATA	43R1980				ThinkPad External Battery Charger				40Y7625				
128GB SSD SATA 3.0Gb/s 1.8" (2.5" cover)	43N3406				ThinkPad 90W AC Adapter				40Y7659				
320GB Disk SATA 1.5Gb/s (5400 rpm)	43N3403				90W Slim AC/DC Combo Adapter				41N8460				
USB 2.0 Portable Secure 320GB Hard Disk	43R2019				ThinkPad Business Topload Case				43R2476				
USB 2.0 Super Multi-Burner Drive	41N5565				ThinkPad Business Backpack				43R2482				
ThinkPad Adjustable Notebook Stand	40Y7676				T500/R500/W500 15W Privacy Filter				43R2474				
ThinkPad Advanced Dock	250310U				ThinkVision® L1940p Wide 19" Monitor				4424HB6				
Verizon WWAN UNDP Broadband	43R9151				ThinkVision L2240p Wide 22" Monitor				4422HB6				
AT&T WWAN HSPA Broadband Mini PCIe	43R9152				ThinkVision L2440p Wide 24" Monitor				4420HB2				
Other accessories on O-T500 sheet											Other accessories at lenovo.com/accessories		

See footnotes for important warranty information
US models announced August 5, 2008

✦ Intel Centrino® 2 with vPro™ technology

© Lenovo
(CR5-8) August 2008

ThinkPad® T500 2241 (GMA) - Education (Onsite)

Personal Systems Reference (PSREF)

Type-model	Proc- essor GHz	Memory	Wide- screen display	CCFL or LED	Cam- era	Integrated graphics	Disk SATA GB ⁸ rpm	SATA optical	Mini PCIe 802.11 wireless	Mini PCIe WWAN	Mini PCIe UWB or Turbo	Bat- tery Blue- tooth	Workhorse (W) Global (G) Avail Preload date
2241-E1U	P8400	2.26 2GB	15.4" WXGA		Cam	GMA 160G	5400	DVD±RW	Intel 5100 ²⁸	WWAN upg	None	6 Blue Bus 32	No Aug 08
2241-E2U	T9400	2.53 2GB	15.4" WXGA		Cam	GMA 250G	5400	DVD±RW	Intel 5100	WWAN upg	None	6 Blue Bus 32	No Aug 08
2241-E3U	T9400	2.53 2GB	15.4" WXGA		Cam	GMA 160G	7200	DVD±RW	Intel 5100	WWAN upg	None	9 Blue Bus 32	No Aug 08
2241-E4U	P8600	2.40 2GB	15.4" WXGA	LED	Cam	GMA 160G	7200	DVD±RW	Intel 5100	WWAN upg	None	6 Blue Bus 32	No Dec 08
<p>• These models have a limited onsite service²⁴ 3-year limited warranty</p> <p>These educational models are available only to public or private K-12 or higher accredited schools organized and operated exclusively for educational purposes for use by qualified students and teachers.</p>													
Positioning Processor	<i>Premiere performance; two spindles</i> Intel® Core™ 2 Duo processor P8400, P8600, or T9400 with dual-core, Intel HD Boost, 1066MHz system bus; <i>P8400/P8600</i> : 3MB L2 cache; <i>T9400</i> : 6MB L2 cache										Preloaded operating system²⁰ - Microsoft® Windows® Vista® Business Edition (32-bit) - Vista Premium logo		
Memory	2GB std / 8GB max ⁷ / PC3-8500 1066MHz DDR3 , non-parity, dual-channel capable, two 204-pin SO-DIMM sockets; <i>Italics</i> : standard memory in both sockets; no sockets available; <i>Non-italics</i> : standard memory in one socket; one socket available										Preloaded applications¹⁴ • Education software - Microsoft Office OneNote® 2007 (and CD) - VitalSource Library College Edition - Adobe® Instructor Resource Cntr - Adobe Digital School Collection - Photoshop Elements (and CD) - Premier Elements (and DVD) - Acrobat 8 Professional - Contribute 4 • Rescue and Recovery™ • Access Connections™ • Client Security Solution™ • ThinkVantage Productivity Center • ThinkVantage System Update • McAfee VirusScan® Plus with SiteAdvisor™ (30 days of virus definitions) • PC-Doctor™ (diagnostics) • ThinkPad Utilities (Power Manager and Presentation Director) • Adobe® Reader • Windows Live™ Toolbar • Windows Live Search • Fingerprint Software (fingerprint models) • Microsoft Office 2007 Trial (60-day) • Roxio® Creator® Business Edition • Roxio MyDVD® (DVD±RW)		
SATA DVD±RW Ultrabay Slim SATA disk	<i>Some</i> : DVD burner, SATA 1.5Gb/s, Ultrabay Slim, removable (43N3214) One modular bay for interchangeable devices (right side), 9.5mm high bay, flat bezel 160GB⁸ (5400 or 7200 rpm) or 250GB (5400 rpm) / SATA 1.5Gb/s, 2.5" wide, 9.5mm high, removable, upgradable, supports 2nd disk, ThinkPad Shock Mounted Hard Drive, Active Protection System™												
Widescreen display	<i>Some</i> : 15.4" (391mm) WXGA (1280x800) color , anti-glare, CCFL backlight, 200 nits, 16:10 aspect ratio, 300:1 contrast ratio <i>Some</i> : 15.4" (391mm) WXGA (1280x800) color , anti-glare, LED backlight , 190 nits, 16:10 aspect ratio, 300:1 contrast ratio												
Camera	Camera on top of screen, 1.3-megapixel, fixed focus												
Integrated graphics	Intel Graphics Media Accelerator 4500MHD (GMA 4500MHD) , in GM45, digital monitor support via DisplayPort (supports single-link DVI-D via cable 45J7915); <i>Maximum external resolution: 2048x1536@75Hz</i>												
Keyboard TrackPoint® Touch pad ThinkLight™	89-key, ThinkVantage button, spill-resistant, multimedia Fn keys TrackPoint® pointing device, "Press-to-Select," Internet Scroll Bar ¹³ , magnifying glass UltraNav™, wide touch pad below keyboard, Tap Zones, scrolling regions label Illuminates the keyboard to improve visibility in low-light conditions												
Dimensions ³ Weight ² Case color Case material Battery - type Battery - life ¹⁰	<i>6-cell 15.4W" (WxDxH):</i> 14.1" x 10" x 1.2-1.3"; 357.5mm x 255mm x 30-34mm <i>6-cell</i> : starting at 5.9 lb (2.7kg); <i>9-cell</i> : starting at 6.2 lbs (2.8kg) Black <i>Top</i> : Super-Elastic PolyCarbonate (SEPC); <i>Bottom</i> : Carbon-Fiber Reinforced Plastic Lithium Ion 6-cell or 9-cell , supports unique 2nd battery in Ultrabay Slim <i>6-cell</i> : up to 6.3 hr; <i>6-cell plus Ultrabay battery</i> : up to 7.8 hr; <i>9-cell</i> : up to 9.4 hr												
Chipset	Mobile Intel GM45 Express Chipset (Graphics Memory Controller Hub), ICH9M-Enhanced I/O Controller Hub (SATA 3.0Gb/s, USB 2.0, PCI Express® 1.1, PCI 2.3, security chip, ethernet MAC), LPC bus (WPCN385 Super I/O)												
ExpressCard/54 PC Card Smart Card read Multicard reader Ports	One slot (ExpressCard/34, ExpressCard/54) One slot (Type I, Type II), CardBus 32-bit None 7-in-1 reader (MMC, Memory Stick, Mem Stick PRO™, SD, SDHC, XD, XD Type H) Three USB 2.0, external monitor (DB-15), modem (RJ-11), ethernet (RJ-45), IEEE 1394 FireWire 400 (4-pin connector; 1394a-2000 standard)												
Mini PCI Express Intel 5100 ²⁸ WWAN upg 2G Turbo UWB Modem Bluetooth™ Ethernet Intel AMT Audio support Security Security chip Fingerprint reader	Three Mini PCI Express slots 11a/b/g/n wireless ⁴ , Mini PCIe adapter, Intel WiFi Link 5100, 1x2 (Shirley Peak) Wireless WAN upgradable, requires Verizon® (43R9151) or AT&T® (43R9152) None None 56K V.92 ⁶ modem Bluetooth 2.0 wireless, LED indicator Intel 82567LM Gigabit Network Connection (Boazman), PHY, PCIe x1 Intel Active Management Technology (IAMT 4.0) High Definition (HD) Audio, Conexant 20561 codec / stereo speakers, 1 watt / volume up, down, mute buttons / digital microphone, microphone input jack, headphone jack Power-on password, hard disk password, supervisor password, security keyhole Trusted Platform Module, integrated in ICH9M, TCG 1.2-compliant Fingerprint reader on palm rest, swipe sensor, supports the security chip										Supports ThinkVantage® technologies		
Limited warranty ¹²	3-years /1-year battery, limited onsite service²⁴ , 8 am - 5 pm, Mon - Fri coverage excluding holidays, next business day response time / service upgrades ²² available										65-watt (GMA graphics) AC adapter ThinkPad Roll Cage and Top Cover Roll Cage (one-piece magnesium) Climate Savers® certified EPEAT™ Silver rating ENERGY STAR® 4.0-compliant RoHS-compliant International Warranty Service ¹⁷ 24 hour x 7 day ¹⁸ toll-free support during the warranty period ¹² via 800-426-7378		
1GB PC3-8500 DDR3 SODIMM 2GB PC3-8500 DDR3 SODIMM Blu-ray Burner Ultrabay Slim 128GB SSD SATA 3.0Gb/s 1.8" (2.5" cover) 320GB Disk SATA 1.5Gb/s (5400 rpm) USB 2.0 Portable Secure 320GB Hard Disk USB 2.0 Super Multi-Burner Drive ThinkPad Advanced Dock Verizon WWAN UNDP Broadband AT&T WWAN HSPA Broadband Mini PCIe Laser Tilt Wheel Travel Mouse (Bluetooth) Other accessories on O-T500 sheet	43R1987 43R1988 43N3215 43N3406 43N3403 43R2019 41N5565 250310U 43R9151 43R9152 41U5008		T/R/W/SL Series Li-Ion Battery 6-cell T/R/W/SL Series Li-Ion Battery 9-cell Advanced Ultrabay Battery II 3-cell ThinkPad External Battery Charger 90W Slim AC/DC Combo Adapter ThinkPad Business Topload Case ThinkPad Deluxe Expander Case T500/R500/W500 15W Privacy Filter ThinkVision® L1940p Wide 19" Monitor ThinkVision L2240p Wide 22" Monitor ThinkVision L2440x Wide 24" Monitor Other accessories at lenovo.com/accessories		40Y6799 40Y6797 43R9250 40Y7625 41N8460 43R2476 43R2478 43R2474 4424HB6 4422HB6 4421HB2		ThinkPlus™.22 4-year LOR 9x5 NBD 12X5630 Post-warranty annual maintenance agreements at lenovo.com/thinkplus/warranty						

See footnotes for important warranty information

Intel Centrino® 2 with vPro™ technology

© Lenovo

US model announced December 2, 2008; previous models on August 5, 2008

(CR5-9) December 2008

ThinkPad® T500 2056 (Switchable) - Education (Onsite)

Personal Systems Reference (PSREF)

Type-model	Processor	GHz	Memory	Wide-screen display	Camera	Switchable graphics	Disk SATA GB ³ rpm	SATA optical	Mini PCIe 802.11 wireless	Mini PCIe WWAN	Mini PCIe UWB or Turbo cells	Battery	Workhorse (W) Global (G) Avail date
2056-E1U	T9400	2.53	2GB	15.4" WSXGA+	Cam	GMA, HD 3650	160G 7200	DVD±RW	Intel 5100	WWAN upg	None	9	No Aug 08
2056-E2U	T9400	2.53	2GB	15.4" WSXGA+	Cam	GMA, HD 3650	250G 5400	DVD±RW	Intel 5100	WWAN upg	None	9	No Aug 08

• **These models have a limited onsite service²⁴ 3-year limited warranty**

Educational models are available only to public or private K-12 or higher accredited schools organized and operated exclusively for educational purposes for use by qualified students and teachers.

Positioning Processor	<i>Premiere performance; two spindles</i> Intel® Core™ 2 Duo processor T9400 with dual-core, Intel HD Boost, 1066MHz system bus, and 6MB L2 cache										Preloaded operating system²⁰ - Microsoft® Windows® Vista® Business Edition (32-bit) ◇ Vista Premium logo		
Memory	2GB std / 8GB max ⁷ / PC3-8500 1066MHz DDR3 , non-parity, dual-channel capable, two 204-pin SO-DIMM sockets; <i>Italics:</i> standard memory in both sockets; no sockets available; <i>Non-italics:</i> standard memory in one socket; one socket available										Preloaded applications¹⁴ • Education software - Microsoft Office OneNote® 2007 (and CD) - VitalSource Library College Edition - Adobe® Instructor Resource Cntr - Adobe Digital School Collection - Photoshop Elements (and CD) - Premier Elements (and DVD) - Acrobat 8 Professional - Contribute 4 • Rescue and Recovery™ • Access Connections™ • Client Security Solution™ • ThinkVantage Productivity Center • ThinkVantage System Update • McAfee VirusScan® Plus with SiteAdvisor™ (30 days of virus definitions) • PC-Doctor™ (diagnostics) • ThinkPad Utilities (Power Manager and Presentation Director) • Adobe® Reader • Windows Live™ Toolbar • Windows Live Search • Fingerprint Software (fingerprint models) • Microsoft Office 2007 Trial (60-day) • Roxio® Creator® Business Edition • Roxio MyDVD® (DVD±RW)		
SATA Combo SATA DVD±RW Ultrabay Slim SATA disk	<i>Some:</i> CD-RW/DVD-ROM, SATA 1.5Gb/s, 9.5mm Ultrabay Slim, removable (43N3213) <i>Some:</i> DVD burner, SATA 1.5Gb/s, Ultrabay Slim, removable (43N3214) One modular bay for interchangeable devices (right side), 9.5mm high bay, flat bezel 160GB⁸ (7200 rpm) or 250GB (5400 rpm) / SATA 1.5Gb/s, 2.5" wide, 9.5mm high, removable, upgradable, supports 2nd disk, ThinkPad Shock Mounted Hard Drive, Active Protection System™												
Widescreen display Camera	15.4" (391mm) WSXGA+ (1680x1050) color , anti-glare, CCFL backlight, 200 nits, 16:10 aspect ratio, 500:1 contrast ratio <i>Some:</i> camera on top of screen, 1.3-megapixel, fixed focus												
Switchable graphics	Switches between discrete and integrated graphics (Vista only), Intel Graphics Media Accelerator 4500MHD (GMA 4500MHD) , in GM45, and ATI™ Mobility Radeon™ HD 3650 , PCI Express x16, 256MB memory, digital monitor support via DisplayPort (supports single-link DVI-D via cable 45J7915); <i>Maximum external resolution: 2048x1536@75Hz</i>												
Keyboard TrackPoint® Touch pad ThinkLight™	89-key, ThinkVantage button, spill-resistant, multimedia Fn keys TrackPoint® pointing device, "Press-to-Select," Internet Scroll Bar ¹³ , magnifying glass UltraNav™, wide touch pad below keyboard, Tap Zones, scrolling regions label Illuminates the keyboard to improve visibility in low-light conditions												
Dimensions ³ Weight ² Case material Battery - type Battery - life ¹⁰	<i>6-cell 15.4W"</i> (WxDxH): 14.1" x 10" x 1.2-1.3"; 357.5mm x 255mm x 30-34mm <i>9-cell:</i> starting at 6.2 lb (2.8kg) <i>Top:</i> Super-Elastic PolyCarbonate (SEPC); <i>Bottom:</i> Carbon-Fiber Reinforced Plastic Lithium Ion 6-cell or 9-cell , supports unique 2nd battery in Ultrabay Slim <i>9-cell:</i> up to 9.4 hr; <i>9-cell plus Ultrabay battery:</i> up to 10.9 hr												
Chipset	Mobile Intel GM45 Express Chipset (Graphics Memory Controller Hub), ICH9M-Enhanced I/O Controller Hub (SATA 3.0Gb/s, USB 2.0, PCI Express® 1.1, PCI 2.3, security chip, ethernet MAC), LPC bus (WPCN385 Super I/O)												
ExpressCard slot PC Card Std slot Smart Card Read Multicard Reader Ports	One ExpressCard/34 or ExpressCard/54 One Type I or Type II slot, CardBus 32-bit None 7-in-1 reader (MMC, Memory Stick, Mem Stick Pro, SD, SDHC, XD, XD Type H) Three USB 2.0, external monitor (VGA DB-15, DisplayPort), modem (RJ-11), ethernet (RJ-45), IEEE 1394 FireWire 400 (4-pin connector; 1394a-2000 standard)												
Mini PCI Express	Three Mini PCI Express slots 11a/b/g/n wireless ⁴ , Mini PCIe adapter, Intel WiFi Link 5100, 1x2 (Shirley Peak) WWAN upg Wireless WAN upgradable, requires Verizon® (43R9151) or AT&T® (43R9152) 2G Turbo None UWB None Modem 56K V.92 ⁶ modem Bluetooth™ Bluetooth 2.0 wireless, LED indicator Ethernet Intel 82567LM Gigabit Network Connection (Boazman), PHY, PCIe x1 Intel AMT Intel Active Management Technology (IAMT 4.0) Audio support High Definition (HD) Audio, Conexant 20561 codec / stereo speakers, 1 watt / volume up, down, mute buttons / digital microphone, microphone input jack, headphone jack												
Security Security chip Fingerprint reader	Power-on password, hard disk password, supervisor password, security keyhole Trusted Platform Module, integrated in ICH9M, TCG 1.2-compliant Fingerprint reader on palm rest, swipe sensor, supports the security chip										Supports ThinkVantage® technologies		
Limited warranty ¹²	3-years /1-year battery, limited onsite service²⁴ , 8 am - 5 pm, Mon - Fri coverage excluding holidays, next business day response time / service upgrades ²² available										90-watt (ATI graphics) AC adapter ThinkPad Roll Cage and Top Cover Roll Cage (one-piece magnesium) Climate Savers® certified EPEAT™ Silver rating ENERGY STAR® 4.0-compliant RoHS-compliant International Warranty Service ¹⁷ 24 hour x 7 day ¹⁸ toll-free support during the warranty period ¹² via 800-426-7378		
1GB PC3-8500 DDR3 SODIMM 2GB PC3-8500 DDR3 SODIMM Blu-ray Burner Ultrabay Slim SATA 1.5Gb/s Serial ATA Hard Drive Bay Adapter II SATA 128GB SSD SATA 3.0Gb/s 1.8" (2.5" cover) 320GB Disk SATA 1.5Gb/s (5400 rpm) USB 2.0 Portable Secure 320GB Hard Disk USB 2.0 Super Multi-Burner Drive ThinkPad Adjustable Notebook Stand ThinkPad Advanced Dock Verizon WWAN UNDP Broadband AT&T WWAN HSPA Broadband Mini PCIe	43R1987 43R1988 43N3215 43R1980 43N3406 43N3403 43R2019 41N5565 40Y7676 250310U 43R9151 43R9152	T/R/W/SL Series Li-Ion Battery 6-cell T/R/W/SL Series Li-Ion Battery 9-cell Advanced Ultrabay Battery II 3-cell ThinkPad External Battery Charger 90W Slim AC/DC Combo Adapter ThinkPad Business Topload Case ThinkPad Business Backpack T500/R500/W500 15W Privacy Filter ThinkVision® L1940p Wide 19" Monitor ThinkVision L2240p Wide 22" Monitor ThinkVision L2440p Wide 24" Monitor Other accessories at lenovo.com/accessories	40Y6799 40Y6797 43R9250 40Y7625 41N8460 43R2476 43R2482 43R2474 4424HB6 4422HB6 4420HB2										
										ThinkPlus™.22 4-year LOR 9x5 NBD 12X5630 Post-warranty annual maintenance agreements at lenovo.com/thinkplus/warranty			

See footnotes for important warranty information
US models announced August 5, 2008

◆ Intel Centrino® 2 with vPro™ technology

© Lenovo
(CR5-10) August 2008



Lenovo ThinkPad W500



Lenovo ThinkPad W500



Lenovo ThinkPad W500



Lenovo ThinkPad W500



Lenovo ThinkPad W500



Lenovo ThinkPad W500

ThinkPad® W500 4062 (Switchable) - TopSeller

Personal Systems Reference (PSREF)

Type-model	Proc-essor	GHz	Memory	Wide-screen display	Cam-era	Switchable graphics	Disk SATA GB ³ rpm	SATA optical	Mini PCIe 802.11 wireless	Mini PCIe WWAN	Mini PCIe Bat-tery or Turbo cells	Preload	Avail date
4062-24U	T9600	2.80	2GB	15.4" WUXGA	Cam GMA, V5700	160G 7200	DVD±RW	Intel 5100 ²⁸	AT&T ²³	2G Turbo	9 Bus 32	Aug 08	
✗ 4062-25U	T9600	2.80	4GB	15.4" WUXGA	Cam GMA, V5700	200G 7200 FDE	DVD±RW	Intel 5100	AT&T	9 Bus 64	Aug 08		
4062-26U	T9600	2.80	4GB	15.4" WUXGA	Cam GMA, V5700	200G 7200 FDE	DVD±RW	Intel 5100	WWAN upg	9 Bus 32	Aug 08		
4062-27U	T9600	2.80	2GB	15.4" WUXGA	Cam GMA, V5700	160G 7200	DVD±RW	Intel 5100	WWAN upg	9 XP Pro	Aug 08		
4062-35U	T9600	2.80	2GB	15.4" WUXGA	Cam GMA, V5700	160G 7200	DVD±RW	Intel 5100	WWAN upg	9 XP Pro	Sep 08		
4062-36U	T9400	2.53	2GB	15.4" WSXGA+	Cam GMA, V5700	160G 7200	DVD±RW	Intel 5100	WWAN upg	9 XP Pro	Sep 08		
<ul style="list-style-type: none"> • These small and medium business (SMB) models are part of the US TopSeller™ Program • Power-packed engineering with Open GL graphics and ISV certifications 													
Positioning Processor	Mobile workstation; two spindles Intel® Core™ 2 Duo processor T9400 or T9600 with dual-core, Intel HD Boost, 1066MHz system bus, and 6MB L2 cache										Preloaded operating system ²⁰		
Memory	2GB or 4GB std / 8GB max ⁷ / PC3-8500 1066MHz DDR3, non-parity, dual-channel capable, two 204-pin SO-DIMM sockets; <i>Italics:</i> standard memory in both sockets; no sockets available; <i>Non-italics:</i> standard memory in one socket; one socket available										- Some: Microsoft® Windows® XP Professional with Vista® COA - Some: Microsoft Windows Vista Business Edition (32-bit) - Some: Microsoft Windows Vista Business Edition (64-bit) ◇ Vista Premium logo		
SATA DVD±RW Ultrabay Slim SATA disk	DVD burner, SATA 1.5Gb/s, Ultrabay Slim, removable (43N3214) One modular bay for interchangeable devices (right side), 9.5mm high bay, flat bezel 160GB ⁸ (7200 rpm), or 200GB (7200 rpm) Full Disk Encryption [FDE] / SATA 1.5Gb/s, 2.5" wide, 9.5mm high, removable, upgradable, supports 2nd disk, ThinkPad Shock Mounted Hard Drive, Active Protection System™										◆ Preloaded applications ¹⁴ (all OSes) • Rescue and Recovery™ • Access Connections™ • Client Security Solution™ • ThinkVantage Productivity Center • ThinkVantage System Update • McAfee VirusScan® Plus with SiteAdvisor™ (30 days of virus definitions) • PC-Doctor™ (diagnostics) • ThinkPad Utilities (Power Manager and Presentation Director) • Adobe® Reader • Windows Live™ Toolbar • Windows Live Search • Fingerprint Software (fingerprint models) • Microsoft Office 2007 Trial (60-day) • Roxio® Creator® Business Edition • Roxio MyDVD® (DVD±RW)		
Widescreen display	Some: 15.4" (391mm) WSXGA+ (1680x1050) color, anti-glare, CCFL backlight, 200 nits, 16:10 aspect ratio, 500:1 contrast ratio Some: 15.4" (391mm) WUXGA (1920x1200) color, anti-glare, CCFL backlight, 175 nits, 16:10 aspect ratio, 500:1 contrast ratio												
Camera	Camera on top of screen, 1.3-megapixel, fixed focus												
Switchable graphics	Switches between discrete and integrated graphics (Vista only), Intel Graphics Media Accelerator 4500MHD (GMA 4500MHD), in GM45, and ATI™ Mobility FireGL™ V5700, PCI Express x16, 512MB memory, digital monitor support via DisplayPort (supports single-link DVI-D via cable 45J7915); Maximum external resolution: 2048x1536@75Hz												
Keyboard TrackPoint® Touch pad ThinkLight™	89-key, ThinkVantage button, spill-resistant, multimedia Fn keys TrackPoint® pointing device, "Press-to-Select," Internet Scroll Bar ¹³ , magnifying glass UltraNav™, wide touch pad below keyboard, Tap Zones, scrolling regions label Illuminates the keyboard to improve visibility in low-light conditions												
Dimensions ³ Weight ² Case material Battery - type Battery - life ¹⁰	6-cell 15.4W" (WxDxH): 14.1" x 10" x 1.2-1.3"; 357.5mm x 255mm x 30-34mm 9-cell: starting at 6.2 lb (2.8kg) Top: Super-Elastic PolyCarbonate (SEPC); Bottom: Carbon-Fiber Reinforced Plastic Lithium Ion 9-cell, supports unique 2nd battery in Ultrabay Slim 9-cell: up to 9.4 hr; 9-cell plus Ultrabay battery: up to 10.9 hr												
Chipset	Mobile Intel GM45 Express Chipset (Graphics Memory Controller Hub), ICH9M-Enhanced I/O Controller Hub (SATA 3.0Gb/s, USB 2.0, PCI Express® 1.1, PCI 2.3, security chip, ethernet MAC), LPC bus (WPCN385 Super I/O)												
ExpressCard/54 PC Card Smart Card Reader Multicard Reader Ports	One slot (ExpressCard/34, ExpressCard/54) One (Type I, Type II), CardBus 32-bit None 7-in-1 reader (MMC, Memory Stick, Mem Stick Pro, SD, SDHC, XD, XD Type H) Three USB 2.0, external monitor (VGA DB-15, DisplayPort), modem (RJ-11), ethernet (RJ-45), IEEE 1394 FireWire 400 (4-pin connector; 1394a-2000 standard)												
Mini PCI Express Intel 5100 ²⁸ WWAN upg AT&T ²³ 2G Turbo UWB Modem Bluetooth™ Ethernet Intel AMT Audio support	Three Mini PCI Express slots 11a/b/g/n wireless ⁴ , Mini PCIe adapter, Intel WiFi Link 5100, 1x2 (Shirley Peak) Some: Wireless WAN upgradable, requires Verizon® (43R9151) or AT&T® (43R9152) Some: Wireless WAN, Ericsson chipset, Mini PCIe adapter and SIM, GPRS/WCDMA/HSPA, GPS, service contract required with AT&T Some: Intel Turbo Memory, Half-Mini PCIe adapter, 2GB flash, disk-cache accelerator None 56K V.92 ⁶ modem Bluetooth 2.0 wireless, LED indicator Intel 82567LM Gigabit Network Connection (Boazman), PHY, PCIe x1 None High Definition (HD) Audio, Conexant 20561 codec / stereo speakers, 1 watt / volume up, down, mute buttons / digital microphone, microphone input jack, headphone jack										Supports ThinkVantage® technologies		
Security Security chip Fingerprint reader	Power-on password, hard disk password, supervisor password, security keyhole Trusted Platform Module, integrated in ICH9M, TCG 1.2-compliant Fingerprint reader on palm rest, swipe sensor, supports the security chip										90-watt (ATI graphics) AC adapter ThinkPad Roll Cage and Top Cover Roll Cage (one-piece magnesium) Climate Savers® certified EPEAT™ Silver rating ENERGY STAR® 4.0-compliant RoHS-compliant International Warranty Service ¹⁷ 24 hour x 7 day ¹⁸ toll-free support during the warranty period ¹² via 800-426-7378		
Limited warranty ¹²	3-years/1-yr battery - EasyServ™ ¹⁹ depot repair service / service upgrades ²² available										ThinkPlus™.22 2-year LOR 9x5 NBD 41C9175 ThinkPlus 3-year LOR 9x5 NBD 41C9176 ThinkPlus 4-year LOR 9x5 NBD 41C9177 ThinkPlus 5-year LOR 9x5 NBD 41C9179 ThinkPlus 4-year P&L P/U Depot 41C9178 ThinkPlus 5-year P&L P/U Depot 41C9180 Post-warranty annual maintenance agreements at lenovo.com/thinkplus/warranty		
1GB PC3-8500 DDR3 SODIMM (TopSeller) 43R2045 2GB PC3-8500 DDR3 SODIMM (TopSeller) 43R2046 Serial ATA Hard Drive Bay Adapter II SATA 43R1980 128GB SSD SATA 3.0Gb/s 1.8" (2.5" cover) 43N3406 320GB Disk SATA 1.5Gb/s (5400 rpm) 43N3403 USB 2.0 Portable Secure 320GB Hard Disk 43R2019 ThinkPad Advanced Dock 250310U Verizon WWAN UNDP Broadband 43R9151 AT&T WWAN HSPA Broadband Mini PCIe 43R9152 Other accessories on O-T500 sheet	T/R/W/SL Series Li-Ion Battery 6-cell 40Y6799 T/R/W/SL Series Li-Ion Battery 9-cell 40Y6797 Advanced Ultrabay Battery II 3-cell 43R9250 90W Slim AC/DC Combo Adapter 41N8460 ThinkPad Business Topload Case 43R2476 T500/R500/W500 15W Privacy Filter 43R2474 ThinkVision® L1940p Wide 19" Monitor 4424HB6 ThinkVision L2240p Wide 22" Monitor 4422HB6 ThinkVision L2440x Wide 24" Monitor 4421HB2 Other accessories at lenovo.com/accessories												

See footnotes for important warranty information

✦ Intel Centrino® 2 processor technology

© Lenovo

✦ US models announced September 23, 2008; previous models on August 5, 2008

(CR5W-1) September 2008

✗ US model withdrawn effective September 2008

ThinkPad® W500 4061 (Switchable)

Type-model	Proc- essor	GHz	Memory	Wide- screen display	Cam- era	Switchable graphics	Disk SATA GB ⁸ rpm	SATA optical	Mini PCIe 802.11 wireless	Mini PCIe WWAN	Mini PCIe UWB or Turbo	Bat- tery cells	Whorse (W) Gbl (G)	Avail date
4061-2HU	T9400	2.53	4GB	15.4" WSXGA+		GMA, V5700	160G 7200	DVD±RW	Intel 5300 ²⁸	WWAN upg		9	Bus 32	Aug 08
4061-2KU	T9600	2.80	4GB	15.4" WUXGA	Cam	GMA, V5700	200G FDE	DVD±RW	Intel 5300	WWAN upg		9	Bus 32	Aug 08
4061-2ZU	T9400	2.53	4GB	15.4" WSXGA+		GMA, V5700	160G 7200	DVD±RW	Intel 5100 ²⁸	WWAN upg		9	Bus 32 W G	Sep 08
4061-32U	T9600	2.80	4GB	15.4" WUXGA	Cam	GMA, V5700	160G 7200	DVD±RW	Intel 5300	WWAN upg	2GB Turbo	9	Bus 64 W	Sep 08
4061-38U	T9600	2.80	4GB	15.4" WUXGA	Cam	GMA, V5700	160G 7200	DVD±RW	Intel 5300	WWAN upg		9	XP Pro	Sep 08
4061-3FU	T9400	2.53	2GB	15.4" WUXGA		GMA, V5700	160G 7200	DVD±RW	Intel 5300	WWAN upg	2GB Turbo	6	Bus 32 G	Sep 08

• **Power-packed engineering with Open GL graphics and ISV certifications**

Positioning	<i>Mobile workstation; two spindles</i>	Preloaded operating system²⁰ - <i>Some:</i> Microsoft® Windows® XP Professional with Vista® COA - <i>Some:</i> Microsoft Windows Vista Business Edition (32-bit) - <i>Some:</i> Microsoft Windows Vista Business Edition (64-bit) ⇨ Vista Premium logo Preloaded applications¹⁴ (all OSes) • Rescue and Recovery™ • Access Connections™ • Client Security Solution™ • ThinkVantage Productivity Center • ThinkVantage System Update • McAfee VirusScan® Plus with SiteAdvisor™ (30 days of virus definitions) • PC-Doctor™ (diagnostics) • ThinkPad Utilities (Power Manager and Presentation Director) • Adobe® Reader • Windows Live™ Toolbar • Windows Live Search • Fingerprint Software (fingerprint models) • Microsoft Office 2007 Trial (60-day) • Roxio® Creator® Business Edition • Roxio MyDVD® (DVD±RW)
Processor	Intel® Core™ 2 Duo processor T9400 or T9600 with dual-core, Intel HD Boost, 1066MHz system bus, and 6MB L2 cache	
Memory	2GB or 4GB std / 8GB max ⁷ / PC3-8500 1066MHz DDR3, non-parity, dual-channel capable, two 204-pin SO-DIMM sockets; <i>Italics:</i> standard memory in both sockets; no sockets available; <i>Non-italics:</i> standard memory in one socket; one socket available	
SATA DVD±RW Ultrabay Slim SATA disk	DVD burner, SATA 1.5Gb/s, Ultrabay Slim, removable (43N3214) One modular bay for interchangeable devices (right side), 9.5mm high bay, flat bezel 160GB ⁸ (7200 rpm) or 200GB (7200 rpm) Full Disk Encryption [FDE] / SATA 1.5Gb/s, 2.5" wide, 9.5mm high, removable, upgradable, supports 2nd disk, ThinkPad Shock Mounted Hard Drive, Active Protection System™	
Widescreen display	<i>Some:</i> 15.4" (391mm) WSXGA+ (1680x1050) color, anti-glare, CCFL backlight, 200 nits, 16:10 aspect ratio, 500:1 contrast ratio; <i>Some:</i> 15.4" (391mm) WUXGA (1920x1200) color, anti-glare, CCFL backlight, 175 nits, 16:10 aspect ratio, 500:1 contrast ratio	
Camera	<i>Some:</i> camera on top of screen, 1.3-megapixel, fixed focus	
Switchable graphics	Switches between discrete and integrated graphics (Vista only), Intel Graphics Media Accelerator 4500MHD (GMA 4500MHD), in GM45, and ATI™ Mobility FireGL™ V5700, PCI Express x16, 512MB memory, digital monitor support via DisplayPort (supports single-link DVI-D via cable 45J7915); Maximum external resolution: 2048x1536@75Hz	
Keyboard TrackPoint® Touch pad ThinkLight™	89-key, ThinkVantage button, spill-resistant, multimedia Fn keys TrackPoint® pointing device, "Press-to-Select," Internet Scroll Bar ¹³ , magnifying glass UltraNav™, wide touch pad below keyboard, Tap Zones, scrolling regions label Illuminates the keyboard to improve visibility in low-light conditions	
Dimensions ³ Weight ² Case material Battery - type Battery - life ¹⁰	6-cell 15.4W" (WxDxH): 14.1" x 10" x 1.2-1.3"; 357.5mm x 255mm x 30-34mm 9-cell: starting at 6.2 lb (2.8kg) Top: Super-Elastic PolyCarbonate (SEPC); Bottom: Carbon-Fiber Reinforced Plastic Lithium Ion 6-cell or 9-cell, supports unique 2nd battery in Ultrabay Slim 9-cell: up to 9.4 hr; 9-cell plus Ultrabay battery: up to 10.9 hr	
Chipset	Mobile Intel GM45 Express Chipset (Graphics Memory Controller Hub), ICH9M-Enhanced I/O Controller Hub (SATA 3.0Gb/s, USB 2.0, PCI Express® 1.1, PCI 2.3, security chip, ethernet MAC), LPC bus (WPCN385 Super I/O)	
ExpressCard slot PC Card Std slot Smart Card Read Multicard Reader Ports	One ExpressCard/34 or ExpressCard/54 One Type I or Type II slot, CardBus 32-bit None 7-in-1 reader (MMC, Memory Stick, Mem Stick Pro, SD, SDHC, XD, XD Type H) Three USB 2.0, external monitor (VGA DB-15, DisplayPort), modem (RJ-11), ethernet (RJ-45), IEEE 1394 FireWire 400 (4-pin connector; 1394a-2000 standard)	
Mini PCI Express Intel 5100 ²⁸ Intel 5300 ²⁸ WWAN upg 2G Turbo UWB Modem Bluetooth™ Ethernet Intel AMT Audio support	Three Mini PCI Express slots <i>Some:</i> 11a/b/g/n wireless ⁴ , Mini PCIe adapter, Intel WiFi Link 5100, 1x2 (Shirley Peak) <i>Some:</i> 11a/b/g/n wireless ⁴ , Mini PCIe adapter, Intel WiFi Link 5300, 3x3 (Shirley Peak) Wireless WAN upgradable, requires Verizon® (43R9151) or AT&T® (43R9152) <i>Some:</i> Intel Turbo Memory, Half-Mini PCIe adapter, 2GB flash, disk-cache accelerator None 56K V92 ⁶ modem Bluetooth 2.0 wireless, LED indicator Intel 82567LM Gigabit Network Connection (Boazman), PHY, PCIe x1 Intel Active Management Technology (IAMT 4.0) High Definition (HD) Audio, Conexant 20561 codec / stereo speakers, 1 watt / volume up, down, mute buttons / digital microphone, microphone input jack, headphone jack	
Security Security chip Fingerprint reader	Power-on password, hard disk password, supervisor password, security keyhole Trusted Platform Module, integrated in ICH9M, TCG 1.2-compliant Fingerprint reader on palm rest, swipe sensor, supports the security chip	
Limited warranty ¹²	3-years/1-yr battery - EasyServ™ ¹⁹ depot repair service / service upgrades ²² available	
1GB PC3-8500 DDR3 SODIMM 2GB PC3-8500 DDR3 SODIMM Blu-ray Burner Ultrabay Slim SATA 1.5Gb/s Serial ATA Hard Drive Bay Adapter II SATA 128GB SSD SATA 3.0Gb/s 1.8" (2.5" cover) 320GB Disk SATA 1.5Gb/s (5400 rpm) USB 2.0 Portable Secure 320GB Hard Disk ThinkPad Advanced Dock Verizon WWAN UNDP Broadband AT&T WWAN HSPA Broadband Mini PCIe Laser Tilt Wheel Travel Mouse (Bluetooth) Other accessories on O-T500 sheet	43R1987 43R1988 43N3215 43R1980 43N3406 43N3403 43R2019 250310U 43R9151 43R9152 41U5008	
T/R/W/SL Series Li-Ion Battery 6-cell T/R/W/SL Series Li-Ion Battery 9-cell Advanced Ultrabay Battery II 3-cell 90W Slim AC/DC Combo Adapter ThinkPad Business Topload Case ThinkPad Business Backpack DisplayPort to Single-link DVI-D Cable T500/R500/W500 15W Privacy Filter ThinkVision® L1940p Wide 19" Monitor ThinkVision L2240p Wide 22" Monitor ThinkVision L2440x Wide 24" Monitor Other accessories at lenovo.com/accessories	40Y6799 40Y6797 43R9250 41N8460 43R2476 43R2482 45J7915 43R2474 4424HB6 4422HB6 4421HB2	
ThinkPlus™ ²² 2-year LOR 9x5 NBD ThinkPlus 3-year LOR 9x5 NBD ThinkPlus 4-year LOR 9x5 NBD ThinkPlus 5-year LOR 9x5 NBD ThinkPlus 4-year P&L P/U Depot ThinkPlus 5-year P&L P/U Depot Post-warranty annual maintenance agreements at lenovo.com/thinkplus/warranty	41C9175 41C9176 41C9177 41C9178 41C9179 41C9178 41C9180	

See footnotes for important warranty information

✦ Intel Centrino® 2 with vPro™ technology

Ⓜ US models announced September 23, 2008; previous models on August 5, 2008

ThinkPad® W500 4063 (Switchable) - Onsite

Personal Systems Reference (PSREF)

Type-model	Proc- essor	GHz	Memory	Wide- screen display	Cam- era	Switchable graphics	Disk SATA GB ⁸ rpm	SATA optical	Mini PCIe 802.11 wireless	Mini PCIe WWAN	Mini PCIe UWB or Turbo	Bat- tery cells	Whorse (W) GMP(P) avail	Preload Gbl (G) date
4063-33U	T9400	2.53	4GB	15.4"	WSXGA+	GMA, V5700	160G 7200	DVD±RW	Intel 5100 ²⁸	WWAN upg		9	Bus 32	WGP Sep 08
4063-34U	T9600	2.80	4GB	15.4"	WUXGA	Cam GMA, V5700	160G 7200	DVD±RW	Intel 5300 ²⁸	WWAN upg	2GB Turbo	9	Bus 64	W Sep 08
4063-3FU	T9400	2.53	2GB	15.4"	WUXGA	GMA, V5700	160G 7200	DVD±RW	Intel 5300	WWAN upg	2GB Turbo	6	Bus 32	GP Sep 08

- Some models are part of the Global Models Plus program with limited onsite service²⁴ 3-year limited warranty
- Power-packed engineering with Open GL graphics and ISV certifications

Positioning	<i>Mobile workstation; two spindles</i>												
Processor	Intel® Core™ 2 Duo processor T9400 or T9600 with dual-core, Intel HD Boost, 1066MHz system bus, and 6MB L2 cache												
Memory	2GB or 4GB std / 8GB max ⁷ / PC3-8500 1066MHz DDR3, non-parity, dual-channel capable, two 204-pin SO-DIMM sockets; <i>Italics:</i> standard memory in both sockets; no sockets available; <i>Non-italics:</i> standard memory in one socket; one socket available												
SATA DVD±RW	DVD burner, SATA 1.5Gb/s, Ultrabay Slim, removable (43N3214)												
Ultrabay Slim	One modular bay for interchangeable devices (right side), 9.5mm high bay, flat bezel												
SATA disk	160GB ⁸ (7200 rpm) / SATA 1.5Gb/s, 2.5" wide, 9.5mm high, removable, upgradable, supports 2nd disk, ThinkPad Shock Mounted Hard Drive, Active Protection System™												
Widescreen display	<i>Some:</i> 15.4" (391mm) WSXGA+ (1680x1050) color, anti-glare, CCFL backlight, 200 nits, 16:10 aspect ratio, 500:1 contrast ratio; <i>Some:</i> 15.4" (391mm) WUXGA (1920x1200) color, anti-glare, CCFL backlight, 175 nits, 16:10 aspect ratio, 500:1 contrast ratio												
Camera	<i>Some:</i> camera on top of screen, 1.3-megapixel, fixed focus												
Switchable graphics	Switches between discrete and integrated graphics (Vista only), Intel Graphics Media Accelerator 4500MHD (GMA 4500MHD), in GM45, and ATI™ Mobility FireGL™ V5700, PCI Express x16, 512MB memory, digital monitor support via DisplayPort (supports single-link DVI-D via cable 45J7915); <i>Maximum external resolution:</i> 2048x1536 @75Hz												
Keyboard	89-key, ThinkVantage button, spill-resistant, multimedia Fn keys												
TrackPoint®	TrackPoint® pointing device, "Press-to-Select," Internet Scroll Bar ¹³ , magnifying glass												
Touch pad	UltraNav™, wide touch pad below keyboard, Tap Zones, scrolling regions label												
ThinkLight™	Illuminates the keyboard to improve visibility in low-light conditions												
Dimensions ³	6-cell 15.4W" (WxDxH): 14.1" x 10" x 1.2–1.3"; 357.5mm x 255mm x 30–34mm												
Weight ²	9-cell: starting at 6.2 lb (2.8kg)												
Case material	<i>Top:</i> Super-Elastic PolyCarbonate (SEPC); <i>Bottom:</i> Carbon-Fiber Reinforced Plastic												
Battery - type	Lithium Ion 6-cell or 9-cell, supports unique 2nd battery in Ultrabay Slim												
Battery - life ¹⁰	9-cell: up to 9.4 hr; 9-cell plus Ultrabay battery: up to 10.9 hr												
Chipset	Mobile Intel GM45 Express Chipset (Graphics Memory Controller Hub), ICH9M-Enhanced I/O Controller Hub (SATA 3.0Gb/s, USB 2.0, PCI Express® 1.1, PCI 2.3, security chip, ethernet MAC), LPC bus (WPCN385 Super I/O)												
ExpressCard slot	One ExpressCard/34 or ExpressCard/54												
PC Card Std slot	One Type I or Type II slot, CardBus 32-bit												
Smart Card Read	None												
Multicard Reader	7-in-1 reader (MMC, Memory Stick, Mem Stick Pro, SD, SDHC, XD, XD Type H)												
Ports	Three USB 2.0, external monitor (VGA DB-15, DisplayPort), modem (RJ-11), ethernet (RJ-45), IEEE 1394 FireWire 400 (4-pin connector; 1394a-2000 standard)												
Mini PCI Express	Three Mini PCI Express slots												
Intel 5100 ²⁸	<i>Some:</i> 11a/b/g/n wireless ⁴ , Mini PCIe adapter, Intel WiFi Link 5100, 1x2 (Shirley Peak)												
Intel 5300 ²⁸	<i>Some:</i> 11a/b/g/n wireless ⁴ , Mini PCIe adapter, Intel WiFi Link 5300, 3x3 (Shirley Peak)												
WWAN upg	Wireless WAN upgradable, requires Verizon® (43R9151) or AT&T® (43R9152)												
2G Turbo	<i>Some:</i> Intel Turbo Memory, Half-Mini PCIe adapter, 2GB flash, disk-cache accelerator												
UWB	None												
Modem	56K V.92 ⁶ modem												
Bluetooth™	Bluetooth 2.0 wireless, LED indicator												
Ethernet	Intel 82567LM Gigabit Network Connection (Boazman), PHY, PCIe x1												
Intel AMT	Intel Active Management Technology (IAMT 4.0)												
Audio support	High Definition (HD) Audio, Conexant 20561 codec / stereo speakers, 1 watt / volume up, down, mute buttons / digital microphone, microphone input jack, headphone jack												
Security	Power-on password, hard disk password, supervisor password, security keyhole												
Security chip	Trusted Platform Module, integrated in ICH9M, TCG 1.2-compliant												
Fingerprint reader	Fingerprint reader on palm rest, swipe sensor, supports the security chip												
Limited warranty ¹²	3-years/1-year battery, limited onsite service ²⁴ , 8 am - 5 pm, Mon - Fri coverage excluding holidays, next business day response time / service upgrades ²² available												
1GB PC3-8500 DDR3 SODIMM	43R1987		T/R/W/SL Series Li-Ion Battery 6-cell		40Y6799								
2GB PC3-8500 DDR3 SODIMM	43R1988		T/R/W/SL Series Li-Ion Battery 9-cell		40Y6797								
Serial ATA Hard Drive Bay Adapter II SATA	43R1980		Advanced Ultrabay Battery II 3-cell		43R9250								
128GB SSD SATA 3.0Gb/s 1.8" (2.5" cover)	43N3406		90W Slim AC/DC Combo Adapter		41N8460								
320GB Disk SATA 1.5Gb/s (5400 rpm)	43N3403		ThinkPad Business Topload Case		43R2476								
USB 2.0 Portable Secure 320GB Hard Disk	43R2019		ThinkPad Business Backpack		43R2482								
ThinkPad Advanced Dock	250310U		DisplayPort to Single-link DVI-D Cable		45J7915								
Verizon WWAN UNDP Broadband	43R9151		T500/R500/W500 15W Privacy Filter		43R2474								
AT&T WWAN HSPA Broadband Mini PCIe	43R9152		ThinkVision® L2240p Wide 22" Monitor		4422HB6								
Laser Tilt Wheel Travel Mouse (Bluetooth)	41U5008		ThinkVision L2440x Wide 24" Monitor		4421HB2								
Other accessories on O-T500 sheet	Other accessories at lenovo.com/accessories												

Supports ThinkVantage® technologies

90-watt (ATI graphics) AC adapter
ThinkPad Roll Cage and Top Cover
Roll Cage (one-piece magnesium)
Climate Savers® certified
EPEAT™ Silver rating
ENERGY STAR® 4.0-compliant
RoHS-compliant
International Warranty Service¹⁷
24 hour x 7 day¹⁸ toll-free support
during the warranty period¹²
via 800-426-7378

ThinkPlus™.22 4-year LOR 9x5 NBD
12X5630
Post-warranty annual maintenance
agreements at
lenovo.com/thinkplus/warranty

See footnotes for important warranty information
US models announced September 23, 2008

✦ Intel Centrino® 2 with vPro™ technology

© Lenovo
(CR5W-3) November 2008

Partial list of accessories supported on:

- ThinkPad T500 originally announced on August 5, 2008
- ThinkPad W500 originally announced on August 5, 2008

Memory

1GB PC3-8500 DDR3 SODIMM (TopSeller)	43R2045	ann	11/04/08
1GB PC3-8500 DDR3 SODIMM	43R1987	ann	08/05/08
2GB PC3-8500 DDR3 SODIMM (TopSeller)	43R2046	ann	11/04/08
2GB PC3-8500 DDR3 SODIMM	43R1988	ann	08/05/08

Ultrabay Slim 9.5mm

Serial ATA Hard Drive Bay Adapter II SATA	43R1980	ann	08/05/08
DVD-ROM Ultrabay Slim SATA 1.5Gb/s	43N3212	ann	08/05/08
CD-RW/DVD-ROM Ultrabay Slim SATA	43N3213	ann	08/05/08
DVD Burner Ultrabay Slim SATA 1.5Gb/s	43N3214	ann	08/05/08
Blu-ray™ Burner Ultrabay Slim SATA 1.5Gb/s	43N3215	ann	08/05/08

Storage and removable storage

160GB Disk SATA 1.5Gb/s (5400 rpm) ⁴¹	41N5692	ann	03/20/07
160GB Disk SATA 1.5Gb/s (7200 rpm) ⁴¹	41N5737	ann	10/16/07
200GB Disk FDE SATA 1.5Gb/s (7200 rpm) ⁴¹	41N5738	ann	10/16/07
250GB Disk SATA 1.5Gb/s (5400 rpm) ⁴¹	43R8152	ann	01/15/08
320GB Disk SATA 1.5Gb/s (5400 rpm) ⁴¹	43N3403	ann	08/05/08

⁴¹ Can be used as the main HDD or with Serial ATA Hard Drive Bay Adapter 43R1980 in the Ultrabay or (in the ThinkPad Advanced Dock 250310U with Serial Hard Drive Ultrabay Slim Adapter 40Y8725)

128GB SSD SATA 3.0Gb/s 1.8" (2.5" cover)	43N3406	ann	08/26/08
USB 2.0 Essential Memory Key 4GB	45J7904	ann	06/24/08
USB 2.0 Essential Memory Key 8GB	45J7905	ann	07/15/08
USB 2.0 Essential Memory Key 32GB	45K1258	ann	10/28/08
USB 2.0 Security Memory Key 2GB	41U5119	ann	07/17/07
USB 2.0 Security Memory Key 4GB	41U5120	ann	07/17/07
USB 2.0 Ultra Secure Memory Key 2GB	45J5916	ann	08/26/08
USB 2.0 Ultra Secure Memory Key 4GB	45J5917	ann	08/26/08
USB 2.0 Ultra Secure Memory Key 8GB	45J5918	ann	08/26/08

USB Portable Diskette Drive	05K9276	ann	06/05/00
USB 2.0 CD-RW/DVD-ROM Combo II Drive	40Y8637	ann	01/05/06
USB 2.0 Portable 160GB Hard Disk	43R1784	ann	09/23/08
USB 2.0 Portable Secure 160GB Hard Disk	43R2018	ann	11/18/08
USB 2.0 Portable Secure 320GB Hard Disk	43R2019	ann	11/18/08
USB 2.0 Super Multi-Burner Drive	41N5565	ann	01/23/07

Wireless WAN (Mini PCI Express)

Verizon® WWAN UNDP Broadband Mini PCle	43R9151	ann	08/05/08
AT&T® WWAN HSPA Broadband Mini PCle	43R9152	ann	08/26/08

ThinkPad Expansion

USB 2.0 Lenovo Enhanced Port Replicator	43R8770	ann	02/26/08
ThinkPad Adjustable Notebook Stand	40Y7676	ann	09/20/05
ThinkPad Essential Port Replicator	250510W	ann	09/20/05
ThinkPad Advanced Mini Dock	250410U	ann	09/20/05
ThinkPad Advanced Dock	250310U	ann	09/20/05

Keyboard

TrackPoint Cap Collection	73P2698	ann	12/16/03
USB Numeric Keypad	33L3225	ann	05/01/00
Preferred Pro USB Keyboard	73P5220	ann	06/21/05
Enhanced Performance USB Keyboard	73P2620	ann	03/23/04
Wireless Kybd & Opt Wheel Mouse (via USB)	73P4067	ann	12/07/04
USB Keyboard with UltraNav	31P8950	ann	01/28/03
USB Travel Keyboard with UltraNav	31P9490	ann	04/27/04
Lenovo USB Fingerprint Keyboard	73P4730	ann	02/22/05

Mouse

Optical Wheel Mouse (USB)	06P4069	ann	05/21/03
Optical ScrollPoint® Mouse (USB, PS/2)	31P7405	ann	08/27/02
Optical Wheel Travel Mouse (USB, PS/2)	31P7410	ann	06/04/02
Laser Tilt Wheel Mouse (USB, PS/2)	41U3074	ann	01/23/07
Lenovo Wireless Laser Mouse (blk, via USB)	45K1696	ann	11/25/08
Lenovo Wireless Laser Mouse (red, via USB)	51J0198	ann	11/25/08
Laser Tilt Wheel Travel Mouse (Bluetooth)	41U5008	ann	01/22/08

Security

Kensington® Cable Lock from Lenovo	73P2582	ann	12/29/03
Kensington Twin Head Cable Lock	45K1620	ann	09/30/08
T500/R500/W500 Series 15W Privacy Filter	43R2474	ann	08/05/08
USB Gemplus GemPC Smart Card Reader	41N3040	ann	02/21/06
PC Card Gemplus Smart Card Reader	41N3004	ann	12/13/05
ExpressCard Gemplus Smart Card Reader	41N3043	ann	06/27/06

Multimedia

USB 2.0 Lenovo Multimedia Headset	40Y8518	ann	06/27/06
USB 2.0 Lenovo Webcam	40Y8519	ann	08/29/06

Batteries

T/R/W/SL Series Li-Ion Battery 6-cell	40Y6799	ann	01/05/06
T/R/W/SL Series Li-Ion Battery 9-cell	40Y6797	ann	09/20/05
Advanced Ultrabay Battery II 3-cell ⁴³	43R9250	ann	04/22/08

⁴³Used in Ultrabay Slim bay.
ThinkPad External Battery Charger⁴⁴ 40Y7625 ann 09/20/05
⁴⁴Requires the ThinkPad 90W AC Adapter 40Y7659 (adapter provided with some systems).

More information at www.lenovo.com/alldaycomputing

ThinkPad 65W AC Adapter ⁴⁵	40Y7696	ann	01/05/06
---------------------------------------	---------	-----	----------

⁴⁵Only compatible with the GM45 chipset models.
ThinkPad 90W AC Adapter 40Y7659 ann 09/20/05
ThinkPad 90W Slim AC/DC Combo Adapter 41N8460 ann 11/27/07

More info at www.lenovo.com/support/poweradapters

Charging tips for 90W Slim AC/DC Combo Adapter 41N8460

- Dual (ThinkPad+Phone) Charging Y-Cable 41R4345 ann 12/18/07
- Palm device charge tip (L7) 41R4315 ann 12/18/07
- BlackBerry charge tip (L8a) 41R4478 ann 12/18/07
- iPod and iPhone charge tip (L10a) 41R4481 ann 12/18/07

More information at www.lenovo.com/support/slimadaptertips

Carrying Cases

Up to 15.4" widescreen models:

Lenovo Carrying Case - Messenger Max	41U5253	ann	05/01/07
Lenovo Carr Case - Performance Backpack	41U5254	ann	05/01/07
Lenovo Standard Case	45K1697	ann	11/25/08
Lenovo Standard Backpack	45K1698	ann	11/25/08
ThinkPad Business Topload Case	43R2476	ann	05/13/08
ThinkPad Business Backpack	43R2482	ann	05/13/08
ThinkPad Deluxe Expander Case	43R2478	ann	05/13/08
ThinkPad Executive Leather Case	43R2480	ann	05/13/08

Up to 17.0" widescreen models:

ThinkPad 17W Business Topload Case	43R9117	ann	08/12/08
------------------------------------	---------	-----	----------

Lenovo luxury cases at www.lenovoluxurycases.com

Monitors

ThinkVision® L174 17" Monitor	9227AE1	ann	04/15/08
ThinkVision L1700p 17" Monitor	9417HE2	ann	09/17/08
ThinkVision L1900p 19" Monitor	4431HE1	ann	11/11/08
ThinkVision L1940p Wide 19" Monitor	4424HB6	ann	09/17/08
ThinkVision L200p Wide 20.1" Monitor	4438HB6	ann	04/15/08
ThinkVision L2240p Wide 22" Monitor	4422HB6	ann	09/17/08
ThinkVision L2440p Wide 24" Monitor	4420HB2	ann	09/17/08
ThinkVision L2440x Wide 24" Monitor	4421HB2	ann	09/17/08

Monitor Accessories⁴⁶

DisplayPort to Single-link DVI-D Cable	45J7915	ann	08/05/08
ThinkVision USB Soundbar	40Y7616	ann	08/23/05
ThinkVision Soundbar	45K1263	ann	09/16/08
Kensington Cable Lock from Lenovo	73P2582	ann	12/29/03
Kensington Twin Head Cable Lock	45K1620	ann	09/30/08
ThinkPad Convertible Monitor Stand	40Y7620	ann	01/05/06
Radial Arm	19K4464	ann	05/05/00

⁴⁶Compatible on selected Lenovo and ThinkVision monitors.

More information at www.lenovo.com/support/monitoraccessories

Other accessories at www.lenovo.com/accessories

Accessories Guide pdf at www.lenovo.com/accessoriesguide



Lenovo ThinkPad W700



Lenovo ThinkPad W700 Mini Dock



Lenovo ThinkPad W700



Lenovo ThinkPad W700 with
W700 Mini Dock



Lenovo ThinkPad W700



Lenovo ThinkPad W700

ThinkPad® W700 2758 (TopSeller)

Type-model	Proc- essor	GHz	Memory	Wide- screen display	Cam- era	Discrete graphics memory	Disk(s) SATA GB ³ rpm RAID	SATA optical	Mini PCIe 802.11 wireless	Mini PCIe UWB or Turbo	Card slot	Blue/ Fing Digitizer	Workhorse (W) Global (G) Avail date
2758-28U T9400	2.53	1GB	17" WXGA+	Cam	1GB	2x160G 7200 0	DVD±RW	Intel 5300 ²⁸	Smart	Yes	Wacom	No	Sep 08
2758-4SU T9600	2.80	4GB	17" WUXGA	Cam	512MB	2x160G 7200	DVD±RW	Intel 5300	Smart	Yes	Wacom	No	Sep 08
2758-29U X9100	3.06	4GB	17" WUXGA	Cam	1GB	2x250G 5400 1	DVD±RW	Intel 5300	Smart	Yes	Wacom	No	Sep 08
<ul style="list-style-type: none"> • These small and medium business (SMB) models are part of the US TopSeller™ Program • First 17" widescreen ThinkPad workstation with integrated color calibration and two RAID-capable disks • Select models include digitizer on palm rest and dual-link DVI-D and DisplayPort ports 													
Positioning Processor	Mobile workstation; three spindles Intel® Core™ 2 Duo processor T9400 or T9600 with dual-core, Intel HD boost, 1066MHz system bus, and 6MB L2 cache or Intel Core 2 Extreme processor X9100 with dual-core, Intel HD boost, 1066MHz system bus, and 6MB L2 cache										Preloaded operating system ²⁰ - Microsoft® Windows® Vista® Business Edition (64-bit) - Vista Premium logo		
Memory	1GB or 4GB std / 8GB max ⁷ / PC3-8500 1066MHz DDR3, non-parity, dual-channel capable, two 204-pin SO-DIMM sockets; <i>Italics:</i> standard memory in both sockets; no sockets available; <i>Non-italics:</i> standard memory in one socket; one socket available										Preloaded applications ¹⁴ • Rescue and Recovery™ • Access Connections™ • Client Security Solution™ • ThinkVantage Productivity Center • ThinkVantage System Update • McAfee VirusScan® Plus with SiteAdvisor™ (30 days of virus definitions) • PC-Doctor™ (diagnostics) • ThinkPad Utilities (Power Manager and Presentation Director) • Adobe® Reader • Windows Live™ Toolbar • Windows Live Search • Fingerprint Software • Microsoft Office 2007 Trial (60-day) • Roxio® Creator® Business Edition • Roxio MyDVD® (DVD±RW) • huey™PRO Monitor Color Correction by Pantone®/X-Rite®		
SATA DVD±RW Ultrabay Enhanced SATA disks	Some: DVD burner, SATA 1.5Gb/s, 12.7mm Ultrabay Enhanced, removable (43R9149) One bay for removable devices, Ultrabay Slim-compatible, 12.7mm high Two disks, 160GB ³ (7200 rpm) or 250GB (5400 rpm) / SATA 1.5Gb/s, 2.5" wide, 9.5mm high, removable, upgradable, supports 3rd disk, ThinkPad Shock Mounted Hard Drive, Active Protection System™												
Widescreen display	Some: 17.0" (431.8mm) WXGA+ (1440x900) color, anti-glare, CCFL backlight, 200 nits, 16:10 aspect ratio, 400:1 contrast ratio, 45% color gamut Some: 17.0" (431.8mm) WUXGA (1920x1200) color, anti-glare, CCFL backlight, 400 nits, 16:10 aspect ratio, 500:1 contrast ratio, 72% color gamut												
Color calibration Camera	huey™PRO Colorimeter by X-Rite® color calibration sensor in palm rest Camera on top of screen, 1.3-megapixel, fixed focus												
Discrete graphics	Some: NVIDIA® Quadro® FX2700M, PCI Express® x16, 512MB memory Some: NVIDIA Quadro FX3700M, PCI Express x16, 1GB memory Max external resolution: 2048x1536@85Hz (VGA DB-15 port); 2048x1536 (DisplayPort)												
Keyboard TrackPoint® Touch pad Numeric keypad Digitizer ThinkLight™	89-key, ThinkVantage button, spill-resistant, multimedia Fn keys TrackPoint® pointing device, "Press-to-Select," Internet Scroll Bar ¹³ , magnifying glass UltraNav™, wide touch pad below keyboard, Tap Zones, scrolling regions label 10-key numeric keypad on right side of keyboard Some: Wacom® digitizer (1280x80mm) on palm rest, digitizer pen, pen holder in right side Two LEDs illuminate the keyboard to improve visibility in low-light conditions										ISV software certifications		
Dimensions ³ Weight ² Case material	9-cell 17W" (WxDxH): 16.1" x 12.2" x 1.6"; 410mm x 310mm x 41mm 9-cell: starting at 8.4 lb (3.8kg) Top: magnesium alloy; Bottom: Polycarbonate/Acrylonitrile-Butadiene-Styrene (PC/ABS) plastic										Supports ThinkVantage® technologies		
Battery - type Battery - life ¹⁰	Lithium Ion 9-cell 9-cell: up to 2.3 hr										ThinkPad W700 Mini Dock Provides desktop expansion and cable management for W700 Series Features: • Security key lock • Security cable lock slot • External monitor ports – Analog VGA DB-15 – Dual-link DVI-D – DisplayPort • Four USB 2.0 ports • eSATA port • Gigabit ethernet port • Microphone in and headphone out • S/PDIF (RCA coaxial digital out) • Requires 170 watt AC adapter		
Chipset	Mobile Intel PM45 Express Chipset (Memory Controller Hub), ICH9M-Enhanced I/O Controller Hub (SATA 3.0Gb/s, RAID 0 or 1 support, USB 2.0, PCI Express 1.1, PCI 2.3, security chip, ethernet MAC), LPC bus (WPCN385 Super I/O) One ExpressCard/34												
ExpressCard/34 ExpressCard/54 Compact Flash Smart Card Reader Multicard Reader Ports	None None Smart Card Reader 7-in-1 reader (MMC, Memory Stick, Mem Stick Pro, SD, SDHC, XD, XD Type H) Five USB 2.0, external monitor (VGA DB-15, dual-link DVI-D, DisplayPort), modem (RJ-11), ethernet (RJ-45), IEEE 1394 FireWire 400 (4-pin connector; 1394a-2000 standard)												
Mini PCI Express Intel 5300 ²⁸ 2G Turbo UWB Modem Bluetooth™ Ethernet Intel AMT Audio support	Three Mini PCI Express slots 11a/b/g/n wireless ⁴ , Mini PCIe adapter, Intel WiFi Link 5300, 3x3 (Shirley Peak) Some: Intel Turbo Memory, Mini PCIe adapter, 2GB flash, disk-cache accelerator None (uses Half-Mini PCIe slot) 56K V.92 ⁶ modem in Communications Daughter Card socket Bluetooth 2.0 wireless, LED indicator Intel 82567LM Gigabit Network Connection (Boazman), PHY, PCIe x1 Intel Active Management Technology (IAMT 4.0) High Definition (HD) Audio, AD1984HD codec / stereo speakers, 1 watt / volume up, down, mute buttons / digital microphone, microphone input jack, headphone jack										170-watt AC adapter RoHS-compliant International Warranty Service ¹⁷ 24 hour x 7 day ¹⁸ toll-free support during the warranty period ¹² via 800-426-7378		
Security Security chip Fingerprint reader	Power-on password, hard disk password, supervisor password, security keyhole Trusted Platform Module, integrated in ICH9M, TCG 1.2-compliant Fingerprint reader on palm rest, swipe sensor, supports the security chip										ThinkPlus™.22 2-year LOR 9x5 NBD 41C9175 ThinkPlus 3-year LOR 9x5 NBD 41C9176 ThinkPlus 4-year LOR 9x5 NBD 41C9177 ThinkPlus 5-year LOR 9x5 NBD 41C9179 ThinkPlus 4-year P&L P/U Depot 41C9178 ThinkPlus 5-year P&L P/U Depot 41C9180 Post-warranty annual maintenance agreements at lenovo.com/thinkplus/warranty		
Limited warranty ¹²	3-year - EasyServ™.19 depot repair service / service upgrades ²² available												
1GB PC3-8500 DDR3 SODIMM (TopSeller) 2GB PC3-8500 DDR3 SODIMM (TopSeller) Blu-ray Burner Ultrabay Enh SATA 1.5Gb/s 128GB SSD SATA 3.0Gb/s 1.8" (2.5" cover) 320GB Disk SATA 1.5Gb/s (5400 rpm) USB 2.0 Ultra Secure Memory Key 8GB ThinkPad W700 Mini Dock Laser Tilt Wheel Travel Mouse (Bluetooth) Other accessories on O-W700 sheet	43R2045 43R2046 43R9150 43N3406 43N3403 45J5918 43R8782 41U5008				W700 Series Li-Ion Battery 9-cell ThinkPad 170W AC Adapter ThinkPad 17W Business Topload Case ThinkVision® USB Soundbar (up to 22") ThinkVision L1700p 17" Monitor ThinkVision L1940p Wide 19" Monitor ThinkVision L2240p Wide 22" Monitor ThinkVision L2440p Wide 24" Monitor				45J7914 41R4421 43R9117 40Y7616 9417HE2 4424HB6 4422HB6 4420HB2				

See footnotes for important warranty information
US models announced August 12, 2008

⚡ Intel Centrino® 2 processor technology
⚡ Intel Centrino 2 with vPro™ technology

⚡ US model withdrawn effective September 2008

Type-model	Processor	Proc- GHz	Memory	Wide-screen display	Cam- era	Discrete graphics memory	Disk(s) SATA GB ⁵ rpm	RAID	SATA optical	Mini PCIe 802.11 wireless	Mini PCIe UWB or Turbo	Card Blue/ slot	Digit- izer	Workhorse (W) Global (G) Avail date
2752-36U	T9600	2.80	4GB	17" WUXGA	Cam	1GB	2x250G 5400	1	DVD±RW	Intel 5300 ²⁸	None	/54 Yes		Bus64 W Sep 08
2752-37U	T9600	2.80	4GB	17" WUXGA	Cam	1GB	2x250G 5400	1	DVD±RW	Intel 5300	None	/54 Yes		Bus64 W Sep 08
2752-38U	T9600	2.80	4GB	17" WUXGA	Cam	1GB	2x320G 5400	0	DVD±RW	Intel 5300	None	CF Yes	Wacom	Bus64 Sep 08
2752-3NU	T9600	2.80	4GB	17" WUXGA	Cam	1GB	2x320G 5400	0	DVD±RW	Intel 5300	None	CF Yes	Wacom	Bus64 Sep 08
2752-3YU	T9600	2.80	2GB	17" WXGA+	Cam	1GB	2x200G FDE	0	DVD±RW	Intel 5300	None	/54 Yes	Wacom	Bus32 W Sep 08

- First 17" widescreen ThinkPad workstation with integrated color calibration and two RAID-capable disks
- Select models include digitizer on palm rest and dual-link DVI-D and DisplayPort ports

Positioning Processor	Mobile workstation; three spindles Intel® Core™ 2 Duo processor T9600 with dual-core, Intel HD boost, 1066MHz system bus, and 6MB L2 cache										Preloaded operating system²⁰ - Some: Microsoft® Windows® Vista® Business Edition (32-bit) - Some: Microsoft Windows Vista Business Edition (64-bit) ◇ Vista Premium logo			
Memory	1GB or 4GB std / 8GB max ⁷ / PC3-8500 1066MHz DDR3 , non-parity, dual-channel capable, two 204-pin SO-DIMM sockets; <i>Italics:</i> standard memory in both sockets; no sockets available; <i>Non-italics:</i> standard memory in one socket; one socket available										Preloaded applications¹⁴ (all OSes; only some listed) • Rescue and Recovery™ • Access Connections™ • Client Security Solution™ • ThinkVantage Productivity Center • ThinkVantage System Update • McAfee VirusScan® Plus with SiteAdvisor™ (30 days of virus definitions) • PC-Doctor™ (diagnostics) • ThinkPad Utilities (Power Manager and Presentation Director) • Windows Live™ Toolbar and Search • Fingerprint Software • Microsoft Office 2007 Trial (60-day) • Roxio® Creator® Business Edition • Roxio MyDVD® (DVD±RW) • huey™PRO Monitor Color Correction by Pantone®/X-Rite®			
SATA DVD±RW Ultrabay Enhanced SATA disk	Some: DVD burner, SATA 1.5Gb/s, 12.7mm Ultrabay Enhanced, removable (43R9149) One bay for removable devices, Ultrabay Slim-compatible, 12.7mm high Two disks, 250GB⁸ (5400 rpm), 320GB (5400 rpm), or 200GB Full Disk Encryption [FDE] (7200 rpm) / SATA 1.5Gb/s, 2.5" wide, 9.5mm high, removable, upgradable, supports 3rd disk, ThinkPad Shock Mounted Hard Drive, Active Protection System™													
Widescreen display	Some: 17.0" (431.8mm) WXGA+ (1440x900) color , anti-glare, CCFL backlight, 200 nits, 16:10 aspect ratio, 400:1 contrast ratio, 45% color gamut Some: 17.0" (431.8mm) WUXGA (1920x1200) color , anti-glare, CCFL backlight, 400 nits, 16:10 aspect ratio, 500:1 contrast ratio, 72% color gamut													
Color calibration Camera	huey™PRO Colorimeter by X-Rite® color calibration sensor in palm rest Camera on top of screen, 1.3-megapixel, fixed focus													
Discrete graphics	NVIDIA® Quadro® FX3700M , PCI Express® x16, 1GB memory; Max external resolution: 2048x1536@85Hz (VGA DB-15 port); 2048x1536 (DisplayPort)													
Keyboard TrackPoint® Touch pad Numeric keypad Digitizer ThinkLight™	89-key, ThinkVantage button, spill-resistant, multimedia Fn keys, Windows/Appl keys TrackPoint® pointing device, "Press-to-Select," Internet Scroll Bar ¹³ , magnifying glass UltraNav™, wide touch pad below keyboard, Tap Zones, scrolling regions label 10-key numeric keypad on right side of keyboard Some: Wacom® digitizer (1280x80mm) on palm rest, digitizer pen, pen holder in right side Two LEDs illuminate the keyboard to improve visibility in low-light conditions													
Dimensions ³ Weight ² Case material	9-cell 17W" (WxDxH): 16.1" x 12.2" x 1.6"; 410mm x 310mm x 41mm 9-cell: starting at 8.4 lb (3.8kg) Top: magnesium alloy; Bottom: Polycarbonate/Acrylonitrile-Butadiene-Styrene (PC/ABS) plastic										ISV software certifications Supports ThinkVantage® technologies			
Battery - type Battery - life ¹⁰	Lithium Ion 9-cell 9-cell: up to 2.3 hr										ThinkPad W700 Mini Dock Provides desktop expansion and cable management for W700 Series Features: • Security key lock • Security cable lock slot • External monitor ports – Analog VGA DB-15 – Dual-link DVI-D – DisplayPort • Four USB 2.0 ports • eSATA port • Gigabit ethernet port • Microphone in and headphone out • S/PDIF (RCA coaxial digital out) • Requires 170 watt AC adapter			
Chipset	Mobile Intel PM45 Express Chipset (Memory Controller Hub), ICH9M-Enhanced I/O Controller Hub (SATA 3.0Gb/s, RAID 0 or 1 support, USB 2.0, PCI Express 1.1, PCI 2.3, security chip, ethernet MAC), LPC bus (WPCN385 Super I/O) One ExpressCard/34 Some: [/54] One ExpressCard/34 or ExpressCard/54 Some: [CF] One Type I slot													
ExpressCard/34 ExpressCard/54 Compact Flash Smart Card Read Multicard Reader Ports	7-in-1 reader (MMC, Memory Stick, Mem Stick Pro, SD, SDHC, XD, XD Type H) Five USB 2.0, external monitor (VGA DB-15, dual-link DVI-D, DisplayPort), modem (RJ-11), ethernet (RJ-45), IEEE 1394 FireWire 400 (4-pin connector; 1394a-2000 standard)													
Mini PCI Express Intel 5300 ²⁸ 2G Turbo UWB Modem Bluetooth™ Ethernet Intel AMT Audio support	Three Mini PCI Express slots 11a/b/g/n wireless ⁴ , Mini PCIe adapter, Intel WiFi Link 5300, 3x3 (Shirley Peak) None None (uses Half-Mini PCIe slot) 56K V.92 ⁶ modem in Communications Daughter Card socket Bluetooth 2.0 wireless, LED indicator Intel 82567LM Gigabit Network Connection (Boazman), PHY, PCIe x1 Intel Active Management Technology (IAMT 4.0) High Definition (HD) Audio, AD1984HD codec / stereo speakers, 1 watt / volume up, down, mute buttons / digital microphone, microphone input jack, headphone jack										170-watt AC adapter RoHS-compliant International Warranty Service ¹⁷ 24 hour x 7 day ¹⁸ toll-free support during the warranty period ¹² via 800-426-7378			
Security Security chip Fingerprint reader	Power-on password, hard disk password, supervisor password, security keyhole Trusted Platform Module, integrated in ICH9M, TCG 1.2-compliant Fingerprint reader on palm rest, swipe sensor, supports the security chip										ThinkPlus™, 22 2-year LOR 9x5 NBD 41C9175 ThinkPlus 3-year LOR 9x5 NBD 41C9176 ThinkPlus 4-year LOR 9x5 NBD 41C9177 ThinkPlus 5-year LOR 9x5 NBD 41C9179 ThinkPlus 4-year P&L P/U Depot 41C9178 ThinkPlus 5-year P&L P/U Depot 41C9180			
Limited warranty ¹²	3-year - EasyServ™, 19 depot repair service / service upgrades ²² available										Post-warranty annual maintenance agreements at lenovo.com/thinkplus/warranty			
1GB PC3-8500 DDR3 SODIMM	43R1987		W700 Series Li-Ion Battery 9-cell		45J7914		ThinkPad 170W AC Adapter		41R4421		ThinkPlus 4-year P&L P/U Depot		41C9178	
2GB PC3-8500 DDR3 SODIMM	43R1988		ThinkPad 17W Business Topload Case		43R9117		ThinkVision® USB Soundbar (up to 22")		40Y7616		ThinkPlus 5-year P&L P/U Depot		41C9180	
Blu-ray Burner Ultrabay Enh SATA 1.5Gb/s	43R9150		ThinkVision L1700p 17" Monitor		9417HE2		ThinkVision L1940p Wide 19" Monitor		4424HB6		Other accessories at lenovo.com/accessories			
128GB SSD SATA 3.0Gb/s 1.8" (2.5" cover)	43N3406		ThinkVision L2240p Wide 22" Monitor		4422HB6		ThinkVision L2440x Wide 24" Monitor		4421HB2					
320GB Disk SATA 1.5Gb/s (5400 rpm)	43N3403													
USB 2.0 Ultra Secure Memory Key 8GB	45J5918													
ThinkPad W700 Mini Dock	43R8782													
Laser Tilt Wheel Travel Mouse (Bluetooth)	41U5008													
Other accessories on O-W700 sheet														

See footnotes for important warranty information
US models announced August 12, 2008

◇ Intel Centrino 2 with vPro™ technology

ThinkPad® W700 2752 (Extreme)

Type-model	Proc- essor	GHz	Memory	Wide- screen display	Cam- era	Discrete graphics memory	Disk(s) SATA GB ³ rpm	RAID	SATA optical	Mini PCIe 802.11 wireless	Mini PCIe UWB or Turbo	CardBlue/ slot	Digit- izer Fing	Digit- izer Preload	Workhorse (W) Global (G) Avail date
2752-6SU	X9100	3.06	4GB	17" WUXGA	Cam	1GB	2x160G 7200	0	DVD±RW	Intel 5300 ²⁸		/54	Yes	Bus64	W G Sep 08
2752-6TU	X9100	3.06	4GB	17" WUXGA	Cam	1GB	2x160G 7200	1	DVD±RW	Intel 5300		CF	Yes	Wacom	Bus64 W G Sep 08
2752-3AU	X9100	3.06	4GB	17" WUXGA	Cam	1GB	2x200G FDE	0	Blu-ray™	Intel 5300		/54	Yes	Wacom	Ult64 Sep 08
2752-6UU	X9100	3.06	4GB	17" WUXGA	Cam	1GB	2x160G 7200	0	DVD±RW	Intel 5300		CF	Yes	Wacom	Bus64 W G Sep 08
2752-3DU	X9100	3.06	4GB	17" WUXGA	Cam	1GB	2x200G FDE	0	Blu-ray	Intel 5300		CF	Yes	Wacom	Bus64 Sep 08
2752-5ZU	X9100	3.06	4GB	17" WUXGA	Cam	1GB	2x200G FDE	0	DVD±RW	Intel 5300		CF	Yes	Wacom	Bus64 Sep 08
2752-62U	X9100	3.06	4GB	17" WUXGA	Cam	1GB	2x160G 7200	0	DVD±RW	Intel 5300	2G Turbo	/54	Yes	Wacom	Bus64 W Sep 08
2752-43U	X9100	3.06	4GB	17" WUXGA	Cam	1GB	2x200G FDE	0	Blu-ray	Intel 5300		/54	Yes	Wacom	Ult64 W Sep 08
2752-6ZU	X9100	3.06	4GB	17" WUXGA	Cam	1GB	2x160G 7200	0	DVD±RW	Intel 5300		CF	Yes	XP Pro	G Sep 08
2752-72U	X9100	3.06	4GB	17" WUXGA	Cam	1GB	2x160G 7200	0	DVD±RW	Intel 5300		CF	Yes	Wacom	XP Pro G Sep 08

• **First 17" widescreen ThinkPad workstation with integrated color calibration and two RAID-capable disks**
 • **Select models include digitizer on palm rest and dual-link DVI-D and DisplayPort ports**

Positioning Processor	Mobile workstation; three spindles Intel® Core™ 2 Extreme processor X9100 with dual-core, Intel HD boost, 1066MHz system bus, and 6MB L2 cache	Preloaded operating system²⁰ - Some: Microsoft® Windows® XP Professional with Vista® COA - Some: Microsoft Windows Vista Business Edition (64-bit) - Some: Microsoft Windows Vista Ultimate Edition (64-bit) ♦ Vista Premium logo Preloaded applications¹⁴ (all OSes) • Rescue and Recovery™ • Access Connections™ • Client Security Solution™ • ThinkVantage Productivity Center • ThinkVantage System Update • McAfee VirusScan® Plus with SiteAdvisor™ (30 days of virus definitions) • PC-Doctor™ (diagnostics) • ThinkPad Utilities (Power Manager and Presentation Director) • Adobe® Reader • Windows Live™ Toolbar and Search • Fingerprint Software • Microsoft Office 2007 Trial (60-day) • Roxio® Creator® Business Edition • Roxio MyDVD® (DVD±RW) • huey™PRO Monitor Color Correction by Pantone®/X-Rite® ISV software certifications Supports ThinkVantage® technologies ThinkPad W700 Mini Dock Provides desktop expansion and cable management for W700 Series Features: • Security key lock • Security cable lock slot • External monitor ports – Analog VGA DB-15 – Dual-link DVI-D – DisplayPort • Four USB 2.0 ports • eSATA port • Gigabit ethernet port • Microphone in and headphone out • S/PDIF (RCA coaxial digital out) • Requires 170 watt AC adapter 170-watt AC adapter RoHS-compliant International Warranty Service ¹⁷ 24 hour x 7 day ¹⁸ toll-free support during the warranty period ¹² via 800-426-7378 ThinkPlus™.22 2-year LOR 9x5 NBD 41C9175 ThinkPlus 3-year LOR 9x5 NBD 41C9176 ThinkPlus 4-year LOR 9x5 NBD 41C9177 Post-warranty annual maintenance agreements at lenovo.com/thinkplus/warranty
Memory	4GB std / 8GB max ⁷ / PC3-8500 1066MHz DDR3 , non-parity, dual-channel capable, two 204-pin SO-DIMM sockets; <i>Italics:</i> standard memory in both sockets; no sockets available	
SATA DVD±RW SATA Blu-ray™ UltraBay Enhanced SATA disk	Some: DVD burner, SATA 1.5Gb/s, 12.7mm Ultrabay Enhanced, removable (43R9149) Some: Blu-ray burner, SATA 1.5Gb/s, 12.7mm Ultrabay Enh, removable (43R9150) One bay for removable devices, Ultrabay Slim-compatible, 12.7mm high Two disks, 160GB⁸ (7200 rpm) or 200GB Full Disk Encryption [FDE] (7200 rpm) / SATA 1.5Gb/s, 2.5" wide, 9.5mm high, removable, upgradable, supports 3rd disk, ThinkPad Shock Mounted Hard Drive, Active Protection System™	
Widescreen display	17.0" (431.8mm) WUXGA (1920x1200) color , anti-glare, CCFL backlight, 400 nits, 16:10 aspect ratio, 500:1 contrast ratio, 72% color gamut	
Color calibration	huey™PRO Colorimeter by X-Rite® color calibration sensor in palm rest	
Camera	Camera on top of screen, 1.3-megapixel, fixed focus	
Discrete graphics	NVIDIA® Quadro® FX3700M , PCI Express x16, 1GB memory <i>Max external resolution:</i> 2048x1536@85Hz (VGA DB-15 port); 2048x1536 (DisplayPort)	
Keyboard TrackPoint® Touch pad Numeric keypad Digitizer ThinkLight™	89-key, ThinkVantage button, spill-resistant, multimedia Fn keys TrackPoint® pointing device, "Press-to-Select," Internet Scroll Bar ¹³ , magnifying glass UltraNav™, wide touch pad below keyboard, Tap Zones, scrolling regions label 10-key numeric keypad on right side of keyboard Some: Wacom® digitizer (1280x80mm) on palm rest, digitizer pen, pen holder in right side Two LEDs illuminate the keyboard to improve visibility in low-light conditions	
Dimensions ³ Weight ² Case material	<i>9-cell 17W" (WxDxH):</i> 16.1" x 12.2" x 1.6"; 410mm x 310mm x 41mm <i>9-cell:</i> starting at 8.4 lb (3.8kg) <i>Top:</i> magnesium alloy; <i>Bottom:</i> Polycarbonate/Acrylonitrile-Butadiene-Styrene (PC/ABS) plastic	
Battery - type Battery - life ¹⁰	Lithium Ion 9-cell <i>9-cell:</i> up to 2.3 hr	
Chipset	Mobile Intel PM45 Express Chipset (Memory Controller Hub), ICH9M-Enhanced I/O Controller Hub (SATA 3.0Gb/s, RAID 0 or 1 support, USB 2.0, PCI Express 1.1, PCI 2.3, security chip, ethernet MAC), LPC bus (WPCN385 Super I/O)	
ExpressCard/34 ExpressCard/54 Compact Flash Smart Card Read Multicard Reader Ports	One ExpressCard/34 Some: [54] One ExpressCard/34 or ExpressCard/54 Some: [CF] One Type I slot None 7-in-1 reader (MMC, Memory Stick, Mem Stick Pro, SD, SDHC, XD, XD Type H) Five USB 2.0, external monitor (VGA DB-15, dual-link DVI-D, DisplayPort), modem (RJ-11), ethernet (RJ-45), IEEE 1394 FireWire 400 (4-pin connector; 1394a-2000 standard)	
Mini PCI Express Intel 5300 ²⁸ 2G Turbo UWB Modem Bluetooth™ Ethernet Intel AMT Audio support	Three Mini PCI Express slots 11a/b/g/n wireless ⁴ , Mini PCIe adapter, Intel WiFi Link 5300, 3x3 (Shirley Peak) Some: Intel Turbo Memory, Mini PCIe adapter, 2GB flash, disk-cache accelerator None (uses Half-Mini PCIe slot) 56K V.92 ⁶ modem in Communications Daughter Card socket Bluetooth 2.0 wireless, LED indicator Intel 82567LM Gigabit Network Connection (Boazman), PHY, PCIe x1 Intel Active Management Technology (IAMT 4.0) High Definition (HD) Audio, AD1984HD codec / stereo speakers, 1 watt / volume up, down, mute buttons / digital microphone, microphone input jack, headphone jack Power-on password, hard disk password, supervisor password, security keyhole Trusted Platform Module, integrated in ICH9M, TCG 1.2-compliant	
Security Security chip Fingerprint reader	Power-on password, hard disk password, supervisor password, security keyhole Trusted Platform Module, integrated in ICH9M, TCG 1.2-compliant Fingerprint reader on palm rest, swipe sensor, supports the security chip	
Limited warranty ¹²	3-year - EasyServ™.19 depot repair service / service upgrades ²² available	
1GB PC3-8500 DDR3 SODIMM 2GB PC3-8500 DDR3 SODIMM Blu-ray Burner Ultrabay Enh SATA 1.5Gb/s 128GB SSD SATA 3.0Gb/s 1.8" (2.5" cover) 320GB Disk SATA 1.5Gb/s (5400 rpm) ThinkPad W700 Mini Dock Laser Tilt Wheel Travel Mouse (Bluetooth) Other accessories on O-W700 sheet	43R1987 43R1988 43R9150 43N3406 43N3403 43R8782 41U5008	
	W700 Series Li-Ion Battery 9-cell 45J7914 ThinkPad 170W AC Adapter 41R4421 ThinkPad 17W Business Topload Case 43R9117 ThinkVision® L1700p 17" Monitor 9417HE2 ThinkVision L1940p Wide 19" Monitor 4424HB6 ThinkVision L2240p Wide 22" Monitor 4422HB6 ThinkVision L2440p Wide 24" Monitor 4420HB2 Other accessories at lenovo.com/accessories	

See footnotes for important warranty information
US models announced August 12, 2008

♦ Intel Centrino® 2 processor technology

ThinkPad® W700 2752 (Quad-Core Extreme)

Personal Systems Reference (PSREF)

Type-model	Proc- essor	GHz	Memory	Wide- screen display	Cam- era	Discrete graphics memory	Disk(s) SATA GB ⁵ rpm	SATA RAID	optical	Mini PCIe 802.11 wireless	Mini PCIe UWB or Turbo	Card Blue/ Fing	Digit- izer	Workhorse (W) Global (G) Avail date				
2752-3KU	QX9300	2.53	4GB	17" WUXGA	Cam	1GB	2x320G	5400	0	Blu-ray™	✦ Intel 5300 ²⁸	None	/54	Yes	Wacom	Bus64	No	Sep 08
<ul style="list-style-type: none"> • First 17" widescreen ThinkPad workstation with integrated color calibration and two RAID-capable disks • Select models include digitizer on palm rest and dual-link DVI-D and DisplayPort ports 																		
Positioning Processor	<i>Mobile workstation; three spindles</i> Intel® Core™ 2 Extreme processor QX9300 with quad-core , Intel HD boost, 1066MHz system bus, and 12MB L2 cache														Preloaded operating system²⁰ - Microsoft® Windows® Vista® Business Edition (64-bit) ✦ Vista Premium logo			
Memory	4GB std / 8GB max ⁷ / PC3-8500 1066MHz DDR3 , non-parity, dual-channel capable, two 204-pin SO-DIMM sockets; <i>Italics:</i> standard memory in both sockets; no sockets available; <i>Non-italics:</i> standard memory in one socket; one socket available														Preloaded applications¹⁴ <ul style="list-style-type: none"> • Rescue and Recovery™ • Access Connections™ • Client Security Solution™ • ThinkVantage Productivity Center • ThinkVantage System Update • McAfee VirusScan® Plus with SiteAdvisor™ (30 days of virus definitions) • PC-Doctor™ (diagnostics) • ThinkPad Utilities (Power Manager and Presentation Director) • Adobe® Reader • Windows Live™ Toolbar and Search • Fingerprint Software • Microsoft Office 2007 Trial (60-day) • Roxio® Creator® Business Edition • Roxio MyDVD® (DVD±RW) • huey™PRO Monitor Color Correction by Pantone®/X-Rite® 			
SATA Blu-ray™ Ultrabay Enhanced SATA disk	Blu-ray burner, SATA 1.5Gb/s, 12.7mm Ultrabay Enhanced, removable (43R9150) One bay for removable devices, Ultrabay Slim-compatible, 12.7mm high Two disks, 320GB⁸ (5400 rpm) / SATA 1.5Gb/s, 2.5" wide, 9.5mm high, removable, upgradable, supports 3rd disk, ThinkPad Shock Mounted Hard Drive, Active Protection System™																	
Widescreen display	17.0" (431.8mm) WUXGA (1920x1200) color , anti-glare, CCFL backlight, 400 nits, 16:10 aspect ratio, 500:1 contrast ratio, 72% color gamut																	
Color calibration	huey™PRO Colorimeter by X-Rite® color calibration sensor in palm rest																	
Camera	Camera on top of screen, 1.3-megapixel, fixed focus																	
Discrete graphics	NVIDIA® Quadro® FX3700M , PCI Express x16, 1GB memory; <i>Max external resolution:</i> 2048x1536@85Hz (VGA DB-15 port); 2048x1536 (DisplayPort)																	
Keyboard	89-key, ThinkVantage button, spill-resistant, multimedia Fn keys, Windows/ Appl keys																	
TrackPoint®	TrackPoint® pointing device, "Press-to-Select," Internet Scroll Bar ¹³ , magnifying glass																	
Touch pad	UltraNav™, wide touch pad below keyboard, Tap Zones, scrolling regions label																	
Numeric keypad	10-key numeric keypad on right side of keyboard																	
Digitizer	Wacom® digitizer (1280x80mm) on palm rest, digitizer pen, pen holder in right side																	
ThinkLight™	Two LEDs illuminate the keyboard to improve visibility in low-light conditions														ISV software certifications			
Dimensions ³	<i>9-cell 17W" (WxDxH):</i> 16.1" x 12.2" x 1.6"; 410mm x 310mm x 41mm														Supports ThinkVantage® technologies			
Weight ²	<i>9-cell:</i> starting at 8.4 lb (3.8kg)																	
Case material	<i>Top:</i> magnesium alloy; <i>Bottom:</i> Polycarbonate/Acrylonitrile-Butadiene-Styrene (PC/ABS) plastic																	
Battery - type	Lithium Ion 9-cell																	
Battery - life ¹⁰	<i>9-cell:</i> up to 2.3 hr																	
Chipset	Mobile Intel PM45 Express Chipset (Memory Controller Hub), ICH9M-Enhanced I/O Controller Hub (SATA 3.0Gb/s, RAID 0 or 1 support, USB 2.0, PCI Express 1.1, PCI 2.3, security chip, ethernet MAC), LPC bus (WPCN385 Super I/O)																	
ExpressCard/34	One ExpressCard/34																	
ExpressCard/54	/54 One ExpressCard/34 or ExpressCard/54																	
Compact Flash	None																	
Smart Card Read	None																	
Multicard Reader	7-in-1 reader (MMC, Memory Stick, Mem Stick Pro, SD, SDHC, XD, XD Type H)																	
Ports	Five USB 2.0, external monitor (VGA DB-15, dual-link DVI-D, DisplayPort), modem (RJ-11), ethernet (RJ-45), IEEE 1394 FireWire 400 (4-pin connector; 1394a-2000 standard)																	
Mini PCI Express	Three Mini PCI Express slots																	
Intel 5300 ²⁸	11a/b/g/n wireless ⁴ , Mini PCIe adapter, Intel WiFi Link 5300, 3x3 (Shirley Peak)																	
2G Turbo	<i>Some:</i> Intel Turbo Memory, Mini PCIe adapter, 2GB flash, disk-cache accelerator																	
UWB	None (uses Half-Mini PCIe slot)																	
Modem	56K V.92 ⁶ modem in Communications Daughter Card socket																	
Bluetooth™	Bluetooth 2.0 wireless, LED indicator																	
Ethernet	Intel 82567LM Gigabit Network Connection (Boazman), PHY, PCIe x1																	
Intel AMT	Intel Active Management Technology (IAMT 4.0)																	
Audio support	High Definition (HD) Audio, AD1984HD codec / stereo speakers, 1 watt / volume up, down, mute buttons / digital microphone, microphone input jack, headphone jack																	
Security	Power-on password, hard disk password, supervisor password, security keyhole																	
Security chip	Trusted Platform Module, integrated in ICH9M, TCG 1.2-compliant																	
Fingerprint reader	Fingerprint reader on palm rest, swipe sensor, supports the security chip																	
Limited warranty ¹²	3-year - EasyServ™.19 depot repair service / service upgrades ²² available																	
1GB PC3-8500 DDR3 SODIMM	43R1987			W700 Series Li-Ion Battery 9-cell				45J7914				ThinkPlus 5-year LOR 9x5 NBD						
2GB PC3-8500 DDR3 SODIMM	43R1988			ThinkPad 170W AC Adapter				41R4421				ThinkPlus 4-year LOR 9x5 NBD						
Blu-ray Burner Ultrabay Enh SATA 1.5Gb/s	43R9150			ThinkPad 17W Business Topload Case				43R9117				ThinkPlus 4-year P&L P/U Depot						
128GB SSD SATA 3.0Gb/s 1.8" (2.5" cover)	43N3406			ThinkVision® USB Soundbar (up to 22")				40Y7616				ThinkPlus 5-year P&L P/U Depot						
320GB Disk SATA 1.5Gb/s (5400 rpm)	43N3403			ThinkVision L1700p 17" Monitor				9417HE2				ThinkPlus 5-year P&L P/U Depot						
USB 2.0 Ultra Secure Memory Key 8GB	45J5918			ThinkVision L1940p Wide 19" Monitor				4424HB6				41C9180						
ThinkPad W700 Mini Dock	43R8782			ThinkVision L2240p Wide 22" Monitor				4422HB6				Post-warranty annual maintenance agreements at						
Laser Tilt Wheel Travel Mouse (Bluetooth)	41U5008			ThinkVision L2440p Wide 24" Monitor				4420HB2				lenovo.com/thinkplus/warranty						
Other accessories on O-W700 sheet																		

See footnotes for important warranty information
 US models announced August 12, 2008

✦ Intel Centrino® 2 processor technology

© Lenovo
 (NIC1-4) August 2008

Type-model	Proc- essor	GHz	Memory	Wide- screen display	Cam- era	Discrete graphics memory	Disk(s) SATA GB ³ rpm	SATA RAID optical	Mini PCIe 802.11 wireless	Mini PCIe UWB or Turbo	Card slot	Blue/ Fing	Digit- izer	Workhorse (W) Global (G) Preload GMP (P)	Avail date	
2753-48U	T9400	2.53	1GB	17"	WUXGA	512MB	2x160G 7200	0 Combo	Intel 5300 ²⁸	None	/54	Yes	Bus32		Sep 08	
2753-6SU	X9100	3.06	4GB	17"	WUXGA	1GB	2x160G 7200	0 DVD±RW	Intel 5300	None	/54	Yes	Bus64	W G P	Sep 08	
2753-6TU	X9100	3.06	4GB	17"	WUXGA	1GB	2x160G 7200	1 DVD±RW	Intel 5300	None	CF	Yes	Wacom	W G P	Sep 08	
2753-6UU	X9100	3.06	4GB	17"	WUXGA	1GB	2x160G 7200	0 DVD±RW	Intel 5300	None	CF	Yes	Wacom	W G P	Sep 08	
2753-6ZU	X9100	3.06	4GB	17"	WUXGA	1GB	2x160G 7200	0 DVD±RW	Intel 5300	None	CF	Yes	XP Pro	G P	Sep 08	
2753-72U	X9100	3.06	4GB	17"	WUXGA	1GB	2x160G 7200	0 DVD±RW	Intel 5300	None	CF	Yes	Wacom	XP Pro	G P	Sep 08
<ul style="list-style-type: none"> • Some models are part of the Global Models Plus program with limited onsite service²⁴; 3-year limited warranty • First 17" widescreen ThinkPad workstation with integrated color calibration and two RAID-capable disks 																
Positioning	Uncompromised performance; three spindles													Preloaded operating system ²⁰		
Processor	Intel® Core™ 2 Duo processor T9600 with dual-core, Intel HD boost, 1066MHz system bus, and 6MB L2 cache or Intel Core 2 Extreme processor X9100 with dual-core, Intel HD boost, 1066MHz system bus, and 6MB L2 cache													- Some: Microsoft® Windows® XP Professional with Vista® COA		
Memory	1GB or 4GB std / 8GB max ⁷ / PC3-8500 1066MHz DDR3, non-parity, dual-channel capable, two 204-pin SO-DIMM sockets; <i>Italics:</i> standard memory in both sockets; no sockets available; <i>Non-italics:</i> standard memory in one socket; one socket available													- Some: Microsoft Windows Vista Business Edition (32-bit)		
SATA Combo	Some: DVD-ROM/CD-RW, SATA 1.5Gb/s, 12.7mm Ultrabay Enh, removable (43R9148)													- Some: Microsoft Windows Vista Business Edition (64-bit)		
SATA DVD±RW	Some: DVD burner, SATA 1.5Gb/s, 12.7mm Ultrabay Enhanced, removable (43R9149)													- Some: Microsoft Windows Vista Ultimate Edition (64-bit)		
Ultrabay Enhanced	One bay for removable devices, Ultrabay Slim-compatible, 12.7mm high													- Some: Microsoft Windows Vista Ultimate Edition (64-bit)		
SATA disk	Two disks, 160GB ³ (7200 rpm) / SATA 1.5Gb/s, 2.5" wide, 9.5mm high, removable, upgradable, supports 3rd disk, ThinkPad Shock Mounted Hard Drive, Active Protection System™													<ul style="list-style-type: none"> ◆ Vista Premium logo 		
Widescreen display	17.0" (431.8mm) WUXGA (1920x1200) color, anti-glare, CCFL backlight, 400 nits, 16:10 aspect ratio, 500:1 contrast ratio, 72% color gamut													Preloaded applications ¹⁴ (all OSes)		
Color calibration	huey™PRO Colorimeter by X-Rite® color calibration sensor in palm rest													<ul style="list-style-type: none"> • Rescue and Recovery™ • Access Connections™ • Client Security Solution™ • ThinkVantage Productivity Center • ThinkVantage System Update • McAfee VirusScan® Plus with SiteAdvisor™ (30 days of virus definitions) • PC-Doctor™ (diagnostics) • ThinkPad Utilities (Power Manager and Presentation Director) • Adobe® Reader • Windows Live™ Toolbar • Windows Live Search • Fingerprint Software • Microsoft Office 2007 Trial (60-day) • Roxio® Creator® Business Edition • Roxio MyDVD® (DVD±RW) • huey™PRO Monitor Color Correction by Pantone®/X-Rite® 		
Camera	Some: camera on top of screen, 1.3-megapixel, fixed focus															
Discrete graphics	Some: NVIDIA® Quadro® FX2700M, PCI Express® x16, 512MB memory															
	Some: NVIDIA Quadro FX3700M, PCI Express x16, 1GB memory															
	Max external resolution: 2048x1536@85Hz (VGA DB-15 port); 2048x1536 (DisplayPort)															
Keyboard	89-key, ThinkVantage button, spill-resistant, multimedia Fn keys															
TrackPoint®	TrackPoint® pointing device, "Press-to-Select," Internet Scroll Bar ¹³ , magnifying glass															
Touch pad	UltraNav™, wide touch pad below keyboard, Tap Zones, scrolling regions label															
Numeric keypad	10-key numeric keypad on right side of keyboard															
Digitizer	Some: Wacom® digitizer (1280x80mm) on palm rest, digitizer pen, pen holder in right side															
ThinkLight™	Two LEDs illuminate the keyboard to improve visibility in low-light conditions															
Dimensions ³	9-cell 17W" (WxDxH): 16.1" x 12.2" x 1.6"; 410mm x 310mm x 41mm															
Weight ²	9-cell: starting at 8.4 lb (3.8kg)															
Case material	Top: magnesium alloy; Bottom: Polycarbonate/Acrylonitrile-Butadiene-Styrene (PC/ABS) plastic															
Battery - type	Lithium Ion 9-cell															
Battery - life ¹⁰	9-cell: up to 2.3 hr															
Chipset	Mobile Intel PM45 Express Chipset (Memory Controller Hub), ICH9M-Enhanced I/O Controller Hub (SATA 3.0Gb/s, RAID 0 or 1 support, USB 2.0, PCI Express 1.1, PCI 2.3, security chip, ethernet MAC), LPC bus (WPCN385 Super I/O)													ISV software certifications		
ExpressCard/34	One ExpressCard/34													Supports ThinkVantage® technologies		
ExpressCard/54	Some: [54] One ExpressCard/34 or ExpressCard/54															
Compact Flash	Some: [CF] One Type I slot															
Smart Card Read	None															
Multicard Reader	7-in-1 reader (MMC, Memory Stick, Mem Stick Pro, SD, SDHC, XD, XD Type H)															
Ports	Five USB 2.0, external monitor (VGA DB-15, dual-link DVI-D, DisplayPort), modem (RJ-11), ethernet (RJ-45), IEEE 1394 FireWire 400 (4-pin connector; 1394a-2000 standard)															
Mini PCI Express	Three Mini PCI Express slots															
Intel 5300 ²⁸	11a/b/g/n wireless ⁴ , Mini PCIe adapter, Intel WiFi Link 5300, 3x3 (Shirley Peak)															
2G Turbo	None															
UWB	None (uses Half-Mini PCIe slot)															
Modem	56K V.92 ⁶ modem in Communications Daughter Card socket															
Bluetooth™	Bluetooth 2.0 wireless, LED indicator															
Ethernet	Intel 82567LM Gigabit Network Connection (Boazman), PHY, PCIe x1															
Intel AMT	Intel Active Management Technology (IAMT 4.0)															
Audio support	High Definition (HD) Audio, AD1984HD codec / stereo speakers, 1 watt / volume up, down, mute buttons / digital microphone, microphone input jack, headphone jack															
Security	Power-on password, hard disk password, supervisor password, security keyhole															
Security chip	Trusted Platform Module, integrated in ICH9M, TCG 1.2-compliant															
Fingerprint reader	Fingerprint reader on palm rest, swipe sensor, supports the security chip															
Limited warranty ¹²	3-years/1-year battery, limited onsite service ²⁴ , 8 am - 5 pm, Mon - Fri coverage excluding holidays, next business day response time / service upgrades ²² available													170-watt AC adapter		
														RoHS-compliant		
														International Warranty Service ¹⁷		
														24 hour x 7 day ¹⁸ toll-free support during the warranty period ¹² via 800-426-7378		
1GB PC3-8500 DDR3 SODIMM	43R1987		W700 Series Li-Ion Battery 9-cell		45J7914											
2GB PC3-8500 DDR3 SODIMM	43R1988		ThinkPad 170W AC Adapter		41R4421											
Blu-ray Burner Ultrabay Enh SATA 1.5Gb/s	43R9150		ThinkPad 17W Business Topload Case		43R9117											
128GB SSD SATA 3.0Gb/s 1.8" (2.5" cover)	43N3406		ThinkVision® L1700p 17" Monitor		9417HE2											
320GB Disk SATA 1.5Gb/s (5400 rpm)	43N3403		ThinkVision L1940p Wide 19" Monitor		4424HB6											
ThinkPad W700 Mini Dock	43R8782		ThinkVision L2240p Wide 22" Monitor		4422HB6											
Laser Tilt Wheel Travel Mouse (Bluetooth)	41U5008		ThinkVision L2440x Wide 24" Monitor		4421HB2											
Other accessories on O-W700 sheet														Other accessories at lenovo.com/accessories		
<p>See footnotes for important warranty information US models announced August 12, 2008</p> <p>◆ Intel Centrino® 2 processor technology ◆ Intel Centrino 2 with vPro™ technology</p> <p>© Lenovo (NIC1-5) August 2008</p>																

ThinkPad®



Lenovo ThinkPad W700ds



Lenovo ThinkPad W700ds



Lenovo ThinkPad W700ds



Lenovo ThinkPad W700ds



Lenovo ThinkPad W700ds

Type-model	Proc-essor	Mem-ory	Primary display	Secondary display	Camera	Disk(s) SATA GB ⁸	RAID	SATA optical	Mini PCIe 802.11 wireless	Mini PCIe UWB or Turbo slot	CardBlue/ Finger	Digit-izer	Workhorse (W) Global (G) Avail date
2752-EPU Q9100	2.80	4GB	17" WUXGA	10.6" WXGA	Cam	2x160GB	None	DVD±RW	Intel 5300 ²⁸	None	/54	Yes	Bus64 Jan 09
2752-E7U QX9300	2.80	4GB	17" WUXGA	10.6" WXGA	Cam	2x160GB	None	DVD±RW	Intel 5300	None	/54	Yes	Wacom Bus64 WG Jan 09
<ul style="list-style-type: none"> • <i>ds = dual screen</i> • <i>17" widescreen ThinkPad workstation with integrated color calibration and two RAID-capable disks</i> • <i>Select models include digitizer on palm rest</i> 													
Positioning Processor	<i>Mobile workstation; three spindles</i> Intel® Core™ 2 processor Q9100 with quad-core , Intel HD boost, 1066MHz system bus, and 12MB L2 cache or Intel Core 2 Extreme processor QX9300 with quad-core , Intel HD boost, 1066MHz system bus, and 12MB L2 cache										Preloaded operating system²⁰ - Microsoft® Windows® Vista® Business Edition (64-bit) ⇨ Vista Premium logo		
Memory	4GB std / 8GB max ³¹ / PC3-8500 1066MHz DDR3 , non-parity, dual-channel capable, two 204-pin SO-DIMM sockets; <i>Italics:</i> standard memory in both sockets; no sockets available; <i>Non-italics:</i> standard memory in one socket; one socket available										Preloaded applications¹⁴ <ul style="list-style-type: none"> • Rescue and Recovery™ • Access Connections™ • Client Security Solution™ • ThinkVantage Productivity Center • ThinkVantage System Update • McAfee VirusScan® Plus with SiteAdvisor™ (30 days of virus definitions) • PC-Doctor™ (diagnostics) • ThinkPad Utilities (Power Manager and Presentation Director) • Windows Live™ Toolbar • Windows Live Search • Fingerprint Software • Microsoft Office 2007 Trial (60-day) • Roxio® Creator® Business Edition • Roxio MyDVD® (DVD±RW) • huey™PRO Monitor Color Correction by Pantone®/X-Rite® 		
SATA DVD±RW Ultrabay Enhanced SATA disk	<i>Some:</i> DVD burner, SATA 1.5Gb/s, 12.7mm Ultrabay Enhanced, removable (43R9149) One bay for removable devices, Ultrabay Slim-compatible, 12.7mm high Two disks, 160GB⁹ (7200 rpm) / SATA 1.5Gb/s, 2.5" wide, 9.5mm high, removable, upgradable, supports third disk, ThinkPad Shock Mounted Hard Drive, Active Protection System™												
Displays	<i>Primary:</i> 17.0" (431.8mm) WUXGA (1920x1200) color , widescreen, anti-glare, CCFL backlight, 400 nits, 16:10 aspect ratio, 500:1 contrast ratio, 72% color gamut; <i>Secondary:</i> 10.6" (269.2mm) WXGA+ (768x1280) color , portrait, anti-glare, CCFL backlight, 230 nits, 3:5 aspect ratio, 190:1 contrast ratio, 45% color gamut, slides out of right side of top cover												
Color calibration Camera	huey™PRO Colorimeter by X-Rite® color calibration sensor in palm rest Camera on top of screen, 1.3-megapixel, fixed focus												
Discrete graphics	NVIDIA® Quadro® FX3700M , PCI Express® x16, 1GB memory; <i>Max external resolution:</i> 2048x1536@85Hz (VGA DB-15 port); 2048x1536 (DisplayPort)												
Keyboard TrackPoint® Touch pad Numeric keypad Digitizer ThinkLight™	89-key, ThinkVantage button, spill-resistant, multimedia Fn keys, Windows/Appl keys TrackPoint® pointing device, "Press-to-Select," Internet Scroll Bar ¹³ , magnifying glass UltraNav™, wide touch pad below keyboard, Tap Zones, scrolling regions label 10-key numeric keypad on right side of keyboard <i>Some:</i> Wacom® digitizer (1280x80mm) on palm rest, digitizer pen, pen holder in right side Two LEDs illuminate the keyboard to improve visibility in low-light conditions										ISV software certifications Supports ThinkVantage® technologies		
Dimensions ³ Weight ² Case color Case material	<i>9-cell 17W" (WxDxH):</i> 16.1" x 12.2" x 1.6"; 410mm x 310mm x 41mm <i>9-cell:</i> starting at 8.4 lb (3.8kg) Black <i>Top:</i> magnesium alloy; <i>Bottom:</i> Polycarbonate/Acrylonitrile-Butadiene-Styrene (PC/ABS) plastic										ThinkPad W700 Mini Dock Provides desktop expansion and cable management for W700 Series Features: <ul style="list-style-type: none"> • Security key lock • Security cable lock slot • External monitor ports <ul style="list-style-type: none"> – Analog VGA DB-15 – Dual-link DVI-D – DisplayPort • Four USB 2.0 ports • eSATA port • Gigabit ethernet port • Microphone in and headphone out • S/PDIF (RCA coaxial digital out) • Requires 170 watt AC adapter 		
Battery - type Battery - life ¹⁰	Lithium Ion 9-cell <i>9-cell:</i> up to 2.3 hr												
Chipset	Mobile Intel PM45 Express Chipset (Memory Controller Hub), ICH9M-Enhanced I/O Controller Hub (SATA 3.0Gb/s, RAID 0 or 1 support, USB 2.0, PCI Express 1.1, PCI 2.3, security chip, ethernet MAC), LPC bus (WPCN385 Super I/O)												
ExpressCard/34 ExpressCard/54 Compact Flash Smart Card read Multicard reader Ports	One slot (ExpressCard/34) <i>Some:</i> One slot (ExpressCard/34, ExpressCard/54) None None 7-in-1 reader (MMC, Memory Stick, Mem Stick Pro, SD, SDHC, XD, XD Type H) Five USB 2.0, external monitor (VGA DB-15, dual-link DVI-D, DisplayPort), modem (RJ-11), ethernet (RJ-45), IEEE 1394 FireWire 400 (4-pin conn; 1394a-2000 standard)												
Mini PCI Express Intel 5300 ²⁸ 2G Turbo UWB Modem Bluetooth™ Ethernet Intel AMT Audio support	Three Mini PCI Express slots 11a/b/g/n wireless ⁴ , Mini PCIe adapter, Intel WiFi Link 5300, 3x3 (Shirley Peak) None None (uses Half-Mini PCIe slot) 56K ⁶ V.92 ²⁹ modem in Communications Daughter Card socket Bluetooth 2.0 wireless, LED indicator Intel 82567LM Gigabit Network Connection (Boazman), PHY, PCIe x1 Intel Active Management Technology (IAMT 4.0) High Definition (HD) Audio, AD1984HD codec / stereo speakers, 1 watt / volume up, down, mute buttons / digital microphone, microphone input jack, headphone jack										170-watt AC adapter RoHS-compliant International Warranty Service ¹⁷ 24 hour x 7 day ¹⁸ toll-free support during the warranty period ¹² via 800-426-7378		
Security Security chip Fingerprint reader	Power-on password, hard disk password, supervisor password, security keyhole Trusted Platform Module, integrated in ICH9M, TCG 1.2-compliant Fingerprint reader on palm rest, swipe sensor, supports the security chip										ThinkPlus™.22 2-year LOR 9x5 NBD 41C9175 ThinkPlus 3-year LOR 9x5 NBD 41C9176 ThinkPlus 4-year LOR 9x5 NBD 41C9177 ThinkPlus 5-year LOR 9x5 NBD 41C9179		
Limited warranty ¹²	3-year - EasyServ™.19 depot repair service / service upgrades ²² available										ThinkPlus 4-year P&L P/U Depot 41C9178 ThinkPlus 5-year P&L P/U Depot 41C9180 Post-warranty annual maintenance agreements at lenovo.com/thinkplus/warranty		
1GB PC3-8500 DDR3 SODIMM	43R1987		W700 Series Li-Ion Battery 9-cell		45J7914		ThinkPad 170W AC Adapter		41R4421		ThinkPlus 4-year P&L P/U Depot 41C9178		
2GB PC3-8500 DDR3 SODIMM	43R1988		ThinkPad 17W Business Topload Case		43R9117		ThinkVision® USB Soundbar (up to 22")		40Y7616		ThinkPlus 5-year P&L P/U Depot 41C9180		
Blu-ray Burner Ultrabay Enh SATA 1.5Gb/s	43R9150		ThinkVision L2240p Wide 22" Monitor		4422HB6		ThinkVision L2440x Wide 24" Monitor		4421HB2		Other accessories on O-W700 sheet		
128GB SSD SATA 3.0Gb/s 1.8" (2.5" cover)	43N3406		Other accessories at lenovo.com/accessories										
320GB Disk SATA 1.5Gb/s (5400 rpm)	43N3403												
ThinkPad W700 Mini Dock	43R8782												

See footnotes for important warranty information
 US models announced January 6, 2009

⇨ Intel Centrino 2 with vPro™ technology

Type-model	Proc-essor	Mem-ory	Primary display	Secondary display	Camera	Disk(s) SATA GB ⁸	RAID	SATA optical	Mini PCIe 802.11 wireless	Mini PCIe UWB or Turbo slot	CardBlue/ Digit-izer	Workhorse (W) Global (G) Avail (P) date
2753-E7U QX9300	2.80 GHz	4GB	17" WUXGA	10.6" WXGA	Cam	2x160GB	None	DVD±RW	Intel 5300 ²⁸	None	/54 Yes Wacom	Bus64 WGP Jan 09
<ul style="list-style-type: none"> • ds = dual screen • 17" widescreen ThinkPad workstation with integrated color calibration and two RAID-capable disks • Select models include digitizer on palm rest • These models are part of the Global Models Plus program with limited onsite service²⁴ 3-year limited warranty 												
Positioning	Mobile workstation; three spindles											
Processor	Intel Core 2 Extreme processor QX9300 with quad-core, Intel HD boost, 1066MHz system bus, and 12MB L2 cache											
Memory	4GB std / 8GB max ³¹ / PC3-8500 1066MHz DDR3, non-parity, dual-channel capable, two 204-pin SO-DIMM sockets; <i>Non-italics:</i> standard memory in one socket; one socket available											
SATA DVD±RW Ultrabay Enhanced SATA disk	Some: DVD burner, SATA 1.5Gb/s, 12.7mm Ultrabay Enhanced, removable (43R9149) One bay for removable devices, Ultrabay Slim-compatible, 12.7mm high Two disks, 160GB ⁹ (7200 rpm) / SATA 1.5Gb/s, 2.5" wide, 9.5mm high, removable, upgradable, supports third disk, ThinkPad Shock Mounted Hard Drive, Active Protection System™											
Displays	<i>Primary:</i> 17.0" (431.8mm) WUXGA (1920x1200) color, widescreen, anti-glare, CCFL backlight, 400 nits, 16:10 aspect ratio, 500:1 contrast ratio, 72% color gamut; <i>Secondary:</i> 10.6" (269.2mm) WXGA+ (768x1280) color, portrait, anti-glare, CCFL backlight, 230 nits, 3:5 aspect ratio, 190:1 contrast ratio, 45% color gamut, slides out of right side of top cover											
Color calibration	huey™PRO Colorimeter by X-Rite® color calibration sensor in palm rest											
Camera	Camera on top of screen, 1.3-megapixel, fixed focus											
Discrete graphics	NVIDIA® Quadro® FX3700M, PCI Express® x16, 1GB memory; Max external resolution: 2048x1536@85Hz (VGA DB-15 port); 2048x1536 (DisplayPort)											
Keyboard	89-key, ThinkVantage button, spill-resistant, multimedia Fn keys, Windows/Appl keys											
TrackPoint®	TrackPoint® pointing device, "Press-to-Select," Internet Scroll Bar ¹³ , magnifying glass											
Touch pad	UltraNav™, wide touch pad below keyboard, Tap Zones, scrolling regions label											
Numeric keypad	10-key numeric keypad on right side of keyboard											
Digitizer	Wacom® digitizer (1280x80mm) on palm rest, digitizer pen, pen holder in right side											
ThinkLight™	Two LEDs illuminate the keyboard to improve visibility in low-light conditions											
Dimensions ³	9-cell 17W" (WxDxH): 16.1" x 12.2" x 1.6"; 410mm x 310mm x 41mm											
Weight ²	9-cell: starting at 8.4 lb (3.8kg)											
Case color	Black											
Case material	Top: magnesium alloy; Bottom: Polycarbonate/Acrylonitrile-Butadiene-Styrene (PC/ABS) plastic											
Battery - type	Lithium Ion 9-cell											
Battery - life ¹⁰	9-cell: up to 2.3 hr											
Chipset	Mobile Intel PM45 Express Chipset (Memory Controller Hub), ICH9M-Enhanced I/O Controller Hub (SATA 3.0Gb/s, RAID 0 or 1 support, USB 2.0, PCI Express 1.1, PCI 2.3, security chip, ethernet MAC), LPC bus (WPCN385 Super I/O)											
ExpressCard/34	One slot (ExpressCard/34)											
ExpressCard/54	One slot (ExpressCard/34, ExpressCard/54)											
Compact Flash	None											
Smart Card read	None											
Multicard reader	7-in-1 reader (MMC, Memory Stick, Mem Stick Pro, SD, SDHC, XD, XD Type H)											
Ports	Five USB 2.0, external monitor (VGA DB-15, dual-link DVI-D, DisplayPort), modem (RJ-11), ethernet (RJ-45), IEEE 1394 FireWire 400 (4-pin conn; 1394a-2000 standard)											
Mini PCI Express	Three Mini PCI Express slots											
Intel 5300 ²⁸	11a/b/g/n wireless ⁴ , Mini PCIe adapter, Intel WiFi Link 5300, 3x3 (Shirley Peak)											
2G Turbo	None											
UWB	None (uses Half-Mini PCIe slot)											
Modem	56K ⁶ V.92 ²⁹ modem in Communications Daughter Card socket											
Bluetooth™	Bluetooth 2.0 wireless, LED indicator											
Ethernet	Intel 82567LM Gigabit Network Connection (Boazman), PHY, PCIe x1											
Intel AMT	Intel Active Management Technology (IAMT 4.0)											
Audio support	High Definition (HD) Audio, AD1984HD codec / stereo speakers, 1 watt / volume up, down, mute buttons / digital microphone, microphone input jack, headphone jack											
Security	Power-on password, hard disk password, supervisor password, security keyhole											
Security chip	Trusted Platform Module, integrated in ICH9M, TCG 1.2-compliant											
Fingerprint reader	Fingerprint reader on palm rest, swipe sensor, supports the security chip											
Limited warranty ¹²	3-years/1-year battery, limited onsite service ²⁴ , 8 am - 5 pm, Mon - Fri coverage excluding holidays, next business day response time/ service upgrades ²² available											
1GB PC3-8500 DDR3 SODIMM	43R1987	W700 Series Li-Ion Battery 9-cell	45J7914									
2GB PC3-8500 DDR3 SODIMM	43R1988	ThinkPad 170W AC Adapter	41R4421									
Blu-ray Burner Ultrabay Enh SATA 1.5Gb/s	43R9150	ThinkPad 17W Business Topload Case	43R9117									
128GB SSD SATA 3.0Gb/s 1.8" (2.5" cover)	43N3406	ThinkVision® USB Soundbar (up to 22")	40Y7616									
320GB Disk SATA 1.5Gb/s (5400 rpm)	43N3403	ThinkVision L2240p Wide 22" Monitor	4422HB6									
ThinkPad W700 Mini Dock	43R8782	ThinkVision L2440x Wide 24" Monitor	4421HB2									
Other accessories on O-W700 sheet		Other accessories at lenovo.com/accessories										
Preloaded operating system²⁰ - Microsoft® Windows® Vista® Business Edition (64-bit) ⇨ Vista Premium logo Preloaded applications¹⁴ <ul style="list-style-type: none"> • Rescue and Recovery™ • Access Connections™ • Client Security Solution™ • ThinkVantage Productivity Center • ThinkVantage System Update • McAfee VirusScan® Plus with SiteAdvisor™ (30 days of virus definitions) • PC-Doctor™ (diagnostics) • ThinkPad Utilities (Power Manager and Presentation Director) • Windows Live™ Toolbar • Windows Live Search • Fingerprint Software • Microsoft Office 2007 Trial (60-day) • Roxio® Creator® Business Edition • Roxio MyDVD® (DVD±RW) • huey™PRO Monitor Color Correction by Pantone®/X-Rite® 												
ISV software certifications												
Supports ThinkVantage® technologies												
ThinkPad W700 Mini Dock Provides desktop expansion and cable management for W700 Series Features: <ul style="list-style-type: none"> • Security key lock • Security cable lock slot • External monitor ports <ul style="list-style-type: none"> – Analog VGA DB-15 – Dual-link DVI-D – DisplayPort • Four USB 2.0 ports • eSATA port • Gigabit ethernet port • Microphone in and headphone out • S/PDIF (RCA coaxial digital out) • Requires 170 watt AC adapter 												
170-watt AC adapter												
RoHS-compliant												
International Warranty Service ¹⁷												
24 hour x 7 day ¹⁸ toll-free support during the warranty period ¹² via 800-426-7378												
ThinkPlus™.22 4-year LOR 9x5 NBD 12X5630												
Post-warranty annual maintenance agreements at lenovo.com/thinkplus/warranty												

See footnotes for important warranty information
US models announced January 6, 2009

❖ Intel Centrino 2 with vPro™ technology

Partial list of accessories supported on:

- ThinkPad W700 originally announced on August 12, 2008
- ThinkPad W700ds originally announced on January 6, 2009

Memory

1GB PC3-8500 DDR3 SODIMM (TopSeller)	43R2045	ann 11/04/08
1GB PC3-8500 DDR3 SODIMM	43R1987	ann 08/05/08
2GB PC3-8500 DDR3 SODIMM (TopSeller)	43R2046	ann 11/04/08
2GB PC3-8500 DDR3 SODIMM	43R1988	ann 08/05/08

Ultrabay Slim 9.5mm

Serial ATA Hard Drive Bay Adapter II SATA ⁴⁸	43R1980	ann 08/05/08
CD-RW/DVD-ROM Ultrabay Slim SATA ⁴⁸	43N3213	ann 08/05/08
DVD Burner Ultrabay Slim SATA 1.5Gb/s ⁴⁸	43N3214	ann 08/05/08
Blu-ray™ Burner Ultrabay Slim SATA 1.5Gb/s ⁴⁸	43N3215	ann 08/05/08

⁴⁸ Slim 9.5mm device in 12.7mm bay shows gap above the device.

Ultrabay Enhanced 12.7mm

DVD-ROM Ultrabay Enhanced SATA 1.5Gb/s	43R9147	ann 08/05/08
CD-RW/DVD-ROM Ultrabay Enh SATA	43R9148	ann 08/05/08
DVD Burner Ultrabay Enh SATA 1.5Gb/s	43R9149	ann 08/05/08
Blu-ray™ Burner Ultrabay Enh SATA 1.5Gb/s	43R9150	ann 08/05/08

Storage and removable storage

160GB Disk SATA 1.5Gb/s (7200 rpm) ⁴¹	41N5737	ann 10/16/07
200GB Disk FDE SATA 1.5Gb/s (7200 rpm) ⁴¹	41N5738	ann 10/16/07
250GB Disk SATA 1.5Gb/s (5400 rpm) ⁴¹	43R8152	ann 01/15/08
320GB Disk SATA 1.5Gb/s (5400 rpm) ⁴¹	43N3403	ann 08/05/08

⁴¹ Can be used as the main HDD or with Serial ATA Hard Drive Bay Adapter 43R1980 in the Ultrabay

128GB SSD SATA 3.0Gb/s 1.8" (2.5" cover)	43N3406	ann 08/26/08
USB 2.0 Essential Memory Key 2GB	41U4944	ann 01/23/07
USB 2.0 Essential Memory Key 4GB	45J7904	ann 06/24/08
USB 2.0 Essential Memory Key 8GB	45J7905	ann 07/15/08
USB 2.0 Essential Memory Key 32GB	45K1258	ann 10/28/08
USB 2.0 Security Memory Key 2GB	41U5119	ann 07/17/07
USB 2.0 Security Memory Key 4GB	41U5120	ann 07/17/07
USB 2.0 Ultra Secure Memory Key 1GB	45J5915	ann 08/26/08
USB 2.0 Ultra Secure Memory Key 2GB	45J5916	ann 08/26/08
USB 2.0 Ultra Secure Memory Key 4GB	45J5917	ann 08/26/08
USB 2.0 Ultra Secure Memory Key 8GB	45J5918	ann 08/26/08
USB Portable Diskette Drive	05K9276	ann 06/05/00
USB 2.0 CD-RW/DVD-ROM Combo II Drive	40Y8637	ann 01/05/06
USB 2.0 Portable 160GB Hard Disk	43R1784	ann 09/23/08
USB 2.0 Portable Secure 160GB Hard Disk	43R2018	ann 11/18/08
USB 2.0 Portable Secure 320GB Hard Disk	43R2019	ann 11/18/08
USB 2.0 Super Multi-Burner Drive	41N5565	ann 01/23/07

ThinkPad Expansion

ThinkPad W700 Mini Dock	43R8782	ann 08/12/08
-------------------------	---------	--------------

More information at www.lenovo.com/support/W700minidock

Keyboard

TrackPoint Cap Collection	73P2698	ann 12/16/03
USB Numeric Keypad	33L3225	ann 05/01/00
Preferred Pro USB Keyboard	73P5220	ann 06/21/05
Enhanced Performance USB Keyboard	73P2620	ann 03/23/04
Wireless Kybd & Opt Wheel Mouse (via USB)	73P4067	ann 12/07/04
USB Keyboard with UltraNav	31P8950	ann 01/28/03
USB Travel Keyboard with UltraNav	31P9490	ann 04/27/04
Lenovo USB Fingerprint Keyboard	73P4730	ann 02/22/05

Mouse

Optical Wheel Mouse (USB)	06P4069	ann 05/21/03
Optical ScrollPoint® Mouse (USB, PS/2)	31P7405	ann 08/27/02
Optical Wheel Travel Mouse (USB, PS/2)	31P7410	ann 06/04/02
Laser Tilt Wheel Mouse (USB, PS/2)	41U3074	ann 01/23/07
Lenovo Wireless Laser Mouse (blk, via USB)	45K1696	ann 11/25/08
Lenovo Wireless Laser Mouse (red, via USB)	51J0198	ann 11/25/08
Laser Tilt Wheel Travel Mouse (Bluetooth)	41U5008	ann 01/22/08

Security

Kensington® Cable Lock from Lenovo	73P2582	ann 12/29/03
Kensington Twin Head Cable Lock	45K1620	ann 09/30/08
USB Gemplus GemPC Smart Card Reader	41N3040	ann 02/21/06
ExpressCard Gemplus Smart Card Reader	41N3043	ann 06/27/06

Multimedia

USB 2.0 Lenovo Multimedia Headset	40Y8518	ann 06/27/06
USB 2.0 Lenovo Webcam	40Y8519	ann 08/29/06

Batteries

W700 Series Li-Ion Battery 9-cell	45J7914	ann 08/12/08
ThinkPad 170W AC Adapter	41R4421	ann 08/12/08

More information at www.lenovo.com/alldaycomputing

Carrying Cases

Up to 17.0" widescreen models:

ThinkPad 17W Business Topload Case	43R9117	ann 08/12/08
------------------------------------	---------	--------------

Monitors

ThinkVision® L174 17" Monitor	9227AE1	ann 04/15/08
ThinkVision L1700p 17" Monitor	9417HE2	ann 09/17/08
ThinkVision L1900p 19" Monitor	4431HE1	ann 11/11/08
ThinkVision L1940p Wide 19" Monitor	4424HB6	ann 09/17/08
ThinkVision L200p Wide 20.1" Monitor	4438HB6	ann 04/15/08
ThinkVision L2240p Wide 22" Monitor	4422HB6	ann 09/17/08
ThinkVision L2440p Wide 24" Monitor	4420HB2	ann 09/17/08
ThinkVision L2440x Wide 24" Monitor	4421HB2	ann 09/17/08

Monitor Accessories⁴⁶

ThinkVision USB Soundbar	40Y7616	ann 08/23/05
ThinkVision Soundbar	45K1263	ann 09/16/08
Kensington Cable Lock from Lenovo	73P2582	ann 12/29/03
Kensington Twin Head Cable Lock	45K1620	ann 09/30/08
Radial Arm	19K4464	ann 05/05/00

⁴⁶ Compatible on selected Lenovo and ThinkVision monitors.

More information at www.lenovo.com/support/monitoraccessories

Other accessories at www.lenovo.com/accessories

Accessories Guide pdf at www.lenovo.com/accessoriesguide

ThinkPad® X61 (7675) - TopSeller

Personal Systems Reference (PSREF)

Type-model	Processor	GHz	Memory	Display	Disk SATA GB ⁵ rpm	Optical In UltraBase	ThinkPad X6 UltraBase	Mini PCIe 802.11 wireless	Mini PCIe WWAN or Turbo	Blue-tooth	Finger print reader	Battery cells	Preload	Avail date
7675-7FU	T7300	2.00	1GB	12.1" XGA	160GB 5400			* Intel 11n ²⁸		Blue	Finger	8-cell	Home Basic	Jun 07
7675-55U	T7300	2.00	2GB	12.1" XGA	160GB 5400	Combo	UltraBase	* Intel 11a/b/g ³²	Verizon	Blue	Finger	8-cell	Business 32	Jun 07
7675-4KU	T7300	2.00	1GB	12.1" XGA	120GB 5400			* Intel 11a/b/g		Blue	Finger	4-cell	Business 32	Jun 07
7675-7KU	T7300	2.00	1GB	12.1" XGA	120GB 5400	DVD±RW	UltraBase	* Intel 11n	1G Turbo	Blue	Finger	8-cell	Business 32	Jun 07
7675-59U	T7300	2.00	2GB	12.1" XGA	160GB 5400	DVD±RW	UltraBase	* Intel 11a/b/g	Verizon	Blue	Finger	8-cell	Business 32	Jun 07
7675-8PU	T7250	2.00	1GB	12.1" XGA	120GB 5400			* Intel 11n		Blue	Finger	4-cell	Business 32	Sep 07
7675-92U	T7500	2.20	1GB	12.1" XGA	160GB 5400	DVD±RW	UltraBase	* Intel 11n		Blue	Finger	8-cell	Business 32	Sep 07
7675-93U	T7500	2.20	2GB	12.1" XGA	160GB 7200	DVD±RW	UltraBase	* Intel 11n	1G Turbo	Blue	Finger	8-cell	Business 32	Sep 07
7675-H7U	T8100	2.10	1GB	12.1" XGA	100GB 7200	DVD±RW	UltraBase	* Intel 11n		Blue	Finger	8-cell	XP Pro	Feb 08
7675-HMUT	T8100	2.10	2GB	12.1" XGA	100GB 7200	DVD±RW	UltraBase	* Intel 11n	1G Turbo	Blue	Finger	8-cell	Business 32	Mar 08
7675-K2U	T8300	2.40	1GB	12.1" XGA	160GB 5400	DVD±RW	UltraBase	* Intel 11n	Verizon	Blue	Finger	8-cell	XP Pro	Feb 08
7675-K3U	T8300	2.40	2GB	12.1" XGA	160GB 5400	DVD±RW	UltraBase	* Intel 11n	Verizon	Blue	Finger	8-cell	Business 32	Mar 08

- These small and medium business (SMB) models are part of the US TopSeller™ Program
- These models have a 1-year limited warranty

Positioning Processor	<i>Thinnest and lightest; one spindle</i> Intel® Core™ 2 Duo processor T7250, T7300, T7500, T8100, or T8300 with dual-core, Intel 64 Technology, Enhanced Intel SpeedStep® technology ¹ , Intel Dynamic Acceleration, Execute Disable Bit, Virtualization Technology, 800MHz bus; T7250: 2MB L2 cache; T7300/T7500: 4MB L2 cache; T8100/T8300: 3MB L2 cache	Preloaded operating system²⁰ - Some: Microsoft® Windows® XP Professional with Vista® COA - Some: Microsoft Windows Vista Home Basic Edition (32-bit) - Some: Microsoft Windows Vista Business Edition (32-bit) ✦ 7FU/7KU/8PU/92U: Vista Basic logo ✦ Other Vista models: Vista Premium logo
Memory	1GB std / 4GB max ⁷ / PC2-5300 667MHz DDR2, non-parity, dual-channel capable, two 200-pin SO-DIMM sockets; <i>Italics:</i> standard memory in both sockets; no sockets available; <i>Non-italics:</i> standard memory in 1 socket; 1 socket available	Preloaded applications¹⁴ (all OSes; only some listed) • Rescue and Recovery™ • Access Connections™ • Client Security Solution™ • ThinkVantage Productivity Center • DiskKeeper® Home • PC-Doctor™ (diagnostics) • ThinkPad Utilities • Microsoft Office 2007 Trial (60-day) • Sonic RecordNow and Drive Letter Access (combo, DVD±RW) • Corel® WinDVD® (combo, DVD±RW)
Diskette drive	None (use optional USB-based diskette drive)	Supports ThinkVantage® technologies ThinkPad X6 UltraBase™ • Provides desktop expansion and cable management for X60 Series • Easily connects to the bottom of the X60 Series for traveling • Converts ThinkPad to a two-spindle system with optional flat bezel Ultrabay Slim options in left side: – ThinkPad Advanced Ultrabay Battery II 3-cell (flat) 43R9250 – ThinkPad DVD Ultrabay Slim Burner (flat bezel) 41N5643 – Serial Hard Drive Ultrabay Slim Adapter (flat bezel) 40Y8725 Disks supported: • 200GB FDE 7200 rpm 41N5738 • 320GB Disk 5400 rpm 43N3403
EIDE Combo	Some: DVD-ROM/CD-RW, 24X/24X/24X/8X ²¹ speed, removable from X6 UltraBase	
EIDE DVD±RW	Some: DVD burner, Super Multi-Burner (40Y8623), dual-layer, removable from X6	Other features: • Power button (front) • Stereo speakers (1 watt) • Security key lock, security keyhole, and optional security screw • Serial and parallel ports • Analog VGA monitor port (no DVI) • Four USB 2.0 ports • Gigabit ethernet port • Modem port • Microphone in and headphone out • Requires 65 or 90 watt AC adapter • Retractable feet; 1.48 lb; 670g
Ultrabay™ Slim	Supports Ultrabay Slim devices in optional or standard X6 UltraBase	
Serial ATA disk	100GB⁸ (7200 rpm), 120GB (5400 rpm), or 160GB (5400 or 7200 rpm) / SATA 1.5Gb/s, 9.5mm high, removable, upgradable, supports 2nd disk in std or optional X6 UltraBase, ThinkPad Shock Mounted Hard Drive, Active Protection System™	65-watt (GMA graphics) AC Adapter ENERGY STAR® 4.0-compliant RoHS-compliant International Warranty Service¹⁷ 24 hour x 7 day¹⁸ toll-free support during the warranty period¹² via 800-426-7378
Display	12.1" (308mm) XGA (1024x768) TFT color , anti-glare, 150 nits, 4:3 aspect ratio, 300:1 contrast ratio	
Graphics controller	Intel Graphics Media Accelerator X3100 (GMA X3100) , integrated in GM965	
Graphics - external	External VGA monitor support via analog DB-15 connector / no DVI-out support	
Keyboard	89-key, ThinkVantage button, spill-resistant, multimedia Fn keys, Windows/Appl keys, standard-size ²⁶ keys 97% size of T Series, 18.5mm pitch, 2.5mm stroke	
TrackPoint®	TrackPoint® pointing device, "Press-to-Select," Internet Scroll Bar ¹³ , magnifying glass	
Touch pad	None	
ThinkLight™	Illuminates the keyboard to improve visibility in low-light conditions	
Dimensions ³	<i>without X6 UltraBase; 4-cell:</i> 10.5" x 8.3" x .80-1.39"; 268mm x 211mm x 20-35mm <i>without X6 UltraBase; 8-cell:</i> 10.5" x 9.4" x .80-1.39"; 268mm x 238mm x 20-35mm <i>with Enhanced 4-cell battery:</i> from 3.11 lb (1.41kg); <i>8-cell:</i> from 3.59 lb (1.63kg)	
Weight ²	<i>Color:</i> black; <i>All:</i> magnesium alloy	
Case material	Lithium Ion Enhanced Cap Battery 4-cell or Lithium Ion 8-cell ;	
Battery - type	supports optional Extended Life Battery on base (for two batteries); supports optional Ultrabay Slim battery in optional X6 UltraBase (for two batteries)	
Battery - life ¹⁰	<i>Enh 4-cell:</i> up to 3.9 hr; <i>8-cell:</i> up to 7.8 hr; <i>8-cell and Extended Life Battery:</i> up to 10.7	
Chipset	Mobile Intel GM965 Express Chipset (Graphics Memory Controller Hub); ICH8M-Enhanced I/O Controller Hub (SATA 3.0Gb/s, ATA-100 EIDE, PCI Express® x1, PCI bus, USB, LPC bus, [Bluetooth], [fingerprint]) / PCI bus (Ricoh® R5C847 Cardbus/1394/Multicard) / LPC bus (PC87385 Super I/O, Atmel® 97SC3203 TPM)	
Media slice	Some: X6 UltraBase media slice (see right side)	
Secure Digital slot	One Secure Digital Card slot, supports SD memory cards used in consumer devices	
PC Card slot	One Type I or one Type II, CardBus Plus (34mm ExpressCard via adapter), door	
Ports	Three USB 2.0, DB-15 (external VGA monitor), RJ-11 (modem), RJ-45 (ethernet), IEEE 1394 FireWire 400 (4-pin connector; 1394a-2000 standard)	
Wireless antenna	UltraConnect™ II Antenna / on-off switch for all wireless radios	
Mini PCI Express	Two Mini PCI Express slots / only 802.11 wireless is customer upgradable	
Intel 11a/b/g ³²	Some: 11a/b/g wireless ⁴ , Mini PCIe adapter, Intel PRO/Wireless 3945ABG	
Intel 11n ²⁸	Some: 11a/b/g/n wireless ⁴ , Mini PCIe adapter, Intel Wireless WiFi Link 4965AGN, MIMO 2x3 (Kedron)	
Verizon ¹⁶	Some: Wireless WAN, Sierra Wireless 1xEV-DO Network Adapter, Mini PCIe adapter, EV-DO Rev. A, rod antenna, service contract reqd with Verizon® Wireless	
1G Turbo	Some: Intel Turbo Memory, Mini PCIe adapter, 1GB flash, disk-cache accelerator	
Modem	56K V.92 ⁵ modem in Communications Daughter Card	
Bluetooth™	Bluetooth 2.0 wireless, USB 2.0 interface via ICH8M, LED indicator	
Ethernet	Gigabit ethernet, Intel 82566MM Nineveh (PHY), PCIe x1, PXE	
Intel AMT	Intel Active Management Technology (AMT)	
Audio support	High Definition (HD) Audio, AD1984 codec / mono speaker 0.5 watt, volume up, down, mute buttons / internal microphone, mic input jack (pink), headphone jack (green)	
Security	Power-on password, hard disk password, supervisor password, security keyhole	
Security chip	Trusted Platform Module , Atmel chip, TCG 1.2-compliant	
Fingerprint reader	Fingerprint reader on palm rest , swipe sensor, supports the security chip	
Limited warranty ¹²	1-year - EasyServ™¹⁹ depot repair service / service upgrades²² available	

See footnotes for important warranty information

US models announced March 25, 2008;

previous models on May 31, September 4, 2007, or January 8, 2008

US models withdrawn effective August or December 2007

* Intel Centrino® processor technology

* Intel Centrino with vPro™ technology

© Lenovo (SM3-1) March 2008

Type-model	Proc- essor	GHz	Memory	Display	Disk SATA GB ³ rpm	Optical in UltraBase	ThinkPad X6 UltraBase	Mini PCIe 802.11 wireless	Mini PCIe WWAN or Turbo	Finger Bat- tery tooth reader cells	Workhorse (W) Preload EW 9-month Global (G)	Avail date
7673-74U	T7300	2.00	1GB	12.1" XGA	80GB 5400			* Intel 4965AG ³²		Blue Fing 8-cell	XP Pro	W G Jun 07
7673-66U	T7300	2.00	1GB	12.1" XGA	80GB 5400			* Intel 4965AG		Blue Fing 8-cell	XP Pro	W G Jun 07
7673-65U	T7300	2.00	1GB	12.1" XGA	80GB 5400			* Intel 4965AG		Blue Fing 8-cell	Business 32	W G Jun 07
7673-3HU	T7100	1.80	1GB	12.1" XGA	80GB 5400			* Intel 11a/b/g ³²		Blue Fing 8-cell	Business 64	EW Jun 07
7673-7EU	T7300	2.00	2GB	12.1" XGA	160 5400	DVD±RW	UltraBase	* Intel 11a/b/g		Blue Fing 8-cell	Business 64	Jun 07
7673-4NU	T7300	2.00	2GB	12.1" XGA	120G 5400			* Intel 4965AG		Blue Fing 8-cell	Business 32	W G Jun 07
7673-A5U	T7500	2.20	2GB	12.1" XGA	100G 7200			* Intel 11a/b/g		Blue Fing 8-cell	Business 32	W Oct 07
7673-8TU	T7250	2.00	2GB	12.1" XGA	160G 7200			* Intel 4965AG	1G Turbo	Blue Fing 8-cell	Business 32	W Oct 07
7673-H6U	T8100	2.10	1GB	12.1" XGA	120G 5400			* Intel 11n ²⁸	1G Turbo	Blue Fing 4-cell	Business 32	W G Feb 08
7673-J5U	T8300	2.40	2GB	12.1" XGA	160G 5400			* Intel 11n ²⁸	1G Turbo	Blue Fing 4-cell	Business 32	W G Feb 08
7673-5GU	T7300	2.00	2GB	12.1" XGA	120G 5400			* Intel 4965AG	WWAN upg	Blue Fing 8-cell	Business 32	W Feb 08
Processor	Intel® Core™ 2 Duo processor T7100, T7250, T7300, T7500, T8100, or T8300 with dual-core, Intel 64 Technology, Enhanced Intel SpeedStep® technology ¹ , Intel Dynamic Acceleration, Execute Disable Bit, Virtualization Technology, and 800MHz bus; T7100/T7250: 2MB L2 cache; T7300/T7500: 4MB L2; T8100/T8300: 3MB L2 cache										Preloaded operating system ²⁰	
Memory	1GB or 2GB std / 4GB max ⁷ / PC2-5300 667MHz DDR2, non-parity, dual-channel capable, two 200-pin SO-DIMM sockets; <i>Italics:</i> standard memory in both sockets; no sockets available; <i>Non-italics:</i> standard memory in 1 socket; 1 socket available										- <i>Some:</i> Microsoft® Windows® XP Professional - <i>Some:</i> Microsoft Windows Vista® Home Basic Edition (32-bit) - <i>Some:</i> Microsoft Windows Vista Business Edition (32-bit) ◇ Vista 1GB models: Vista Basic logo ◇ 2GB models: Vista Premium logo	
Diskette drive	None (use optional USB-based diskette drive)										Preloaded applications ¹⁴ (all OSes; only some listed)	
EIDE DVD±RW	<i>Some:</i> DVD burner, Super Multi-Burner (40Y8623), dual-layer, removable from X6										• Rescue and Recovery™	
Ultrabay™ Slim	Supports Ultrabay Slim devices in optional or standard X6 UltraBase										• Access Connections™	
Serial ATA disk	80GB ⁸ (5400 rpm), 100GB (7200 rpm), 120GB (5400), or 160GB (5400 or 7200 rpm) / SATA 1.5Gb/s, 9.5mm high, removable, upgradable, supports 2nd disk in std or optional X6 UltraBase, ThinkPad Shock Mounted Hard Drive, Active Protection System™										• Client Security Solution™	
Display	12.1" (308mm) XGA (1024x768) TFT color, anti-glare, 150 nits, 4:3 aspect ratio, 300:1 contrast ratio										• ThinkVantage Productivity Center • ThinkVantage System Update • Norton Internet Security™	
Graphics controller	Intel Graphics Media Accelerator X3100 (GMA X3100), integrated in GM965										• Diskeeper® Home • PC-Doctor™ (diagnostics)	
Graphics - external	External VGA monitor support via analog DB-15 connector / no DVI-out support										• Fingerprint Software • Microsoft Office 2007 Trial (60-day)	
Keyboard	89-key, ThinkVantage button, spill-resistant, multimedia Fn keys, Windows/Appl keys, standard-size ²⁶ keys 97% size of T Series, 18.5mm pitch, 2.5mm stroke										• Sonic RecordNow and Drive Letter Access (DVD±RW) • Corel® WinDVD® (DVD±RW)	
TrackPoint®	TrackPoint® pointing device, "Press-to-Select," Internet Scroll Bar ¹³ , magnifying glass										Supports ThinkVantage® technologies	
Touch pad	None										ThinkPad X6 UltraBase™	
ThinkLight™	Illuminates the keyboard to improve visibility in low-light conditions										• Provides desktop expansion and cable management for X60 Series • Easily connects to the bottom of the X60 Series for traveling • Converts ThinkPad to a two-spindle system with optional flat bezel Ultrabay Slim options in left side: – ThinkPad Advanced Ultrabay Battery II 3-cell (flat) 43R9250 – ThinkPad DVD Ultrabay Slim Burner (flat bezel) 41N5643 – Serial Hard Drive Ultrabay Slim Adapter (flat bezel) 40Y8725 Disks supported: • 200GB FDE 7200 rpm 41N5738 • 320GB Disk 5400 rpm 43N3403	
Dimensions ³	<i>without X6 UltraBase; 4-cell:</i> 10.5" x 8.3" x .80-1.39"; 268mm x 211mm x 20-35mm <i>without X6 UltraBase; 8-cell:</i> 10.5" x 9.4" x .80-1.39"; 268mm x 238mm x 20-35mm <i>with Enhanced 4-cell battery:</i> from 3.11 lb (1.41kg); <i>8-cell:</i> from 3.59 lb (1.63kg)										Other features: • Stereo speakers (1 watt) • Security key lock, security keyhole, and optional security screw • Serial and parallel ports • Analog VGA monitor port (no DVI) • Four USB 2.0 ports • Gigabit ethernet port • Modem port • Microphone in and headphone out • Requires 65 or 90 watt AC adapter • Retractable feet; 1.48 lb; 670g	
Weight ²											65-watt (GMA graphics) AC Adapter ENERGY STAR® 4.0-compliant RoHS-compliant International Warranty Service ¹⁷ 24 hour x 7 day ¹⁸ toll-free support during the warranty period ¹² via 800-426-7378	
Case material	Color: black; All: magnesium alloy											
Battery - type	Lithium Ion 4-cell or 8-cell; supports optional Extended Life Battery on base (for two batteries); supports optional Ultrabay Slim battery in optional X6 UltraBase (for two batteries)											
Battery - life ¹⁰	<i>Enh 4-cell:</i> up to 3.9 hr; <i>8-cell:</i> up to 7.8 hr; <i>8-cell and Extended Life Battery:</i> up to 10.7											
Chipset	Mobile Intel GM965 Express Chipset (Graphics Memory Controller Hub); ICH8M-Enhanced I/O Controller Hub (SATA 3.0Gb/s, ATA-100 EIDE, PCI Express® x1, PCI bus, USB, LPC bus, [Bluetooth], [fingerprint]) / PCI bus (Ricoh® R5C847 Cardbus/1394/Multicard) / LPC bus (PC87385 Super I/O, Atmel® 97SC3203 TPM)											
Media slice	<i>Some:</i> X6 UltraBase media slice (see right side)											
Secure Digital slot	One Secure Digital Card slot, supports SD memory cards used in consumer devices											
PC Card	One slot (Type I, Type II), CardBus Plus (34mm ExpressCard via adapter), door											
Ports	Three USB 2.0, DB-15 (external VGA monitor), RJ-11 (modem), RJ-45 (ethernet), IEEE 1394 FireWire 400 (4-pin connector; 1394a-2000 standard)											
Wireless antenna	UltraConnect™ II Antenna / on-off switch for all wireless radios											
Mini PCI Express	Two Mini PCI Express slots / 802.11 and WWAN are customer upgradable											
Intel 11a/b/g ³²	<i>Some:</i> 11a/b/g wireless ⁴ , Mini PCIe adapter, Intel PRO/Wireless 3945ABG											
Intel 4965AG ³²	<i>Some:</i> 11a/b/g wireless ⁴ , Mini PCIe adapter, Intel Wireless WiFi Link 4965AG											
Intel 11n ²⁸	<i>Some:</i> 11a/b/g/n wireless ⁴ , Mini PCIe adapter, Intel Wireless WiFi Link 4965AGN, MIMO 2x3 (Kedron)											
WWAN upg ¹⁶	<i>Some:</i> Wireless WAN upgradable, requires Verizon® EV-DO Rev. A Mini PCIe (43R1818)											
1G Turbo	<i>Some:</i> Intel Turbo Memory, Mini PCIe adapter, 1GB flash, disk-cache accelerator											
Modem	56K V.92 ⁹ modem in Communications Daughter Card											
Bluetooth™	<i>Some:</i> Bluetooth 2.0 wireless, USB 2.0 interface via ICH8M, LED indicator											
Ethernet	Gigabit ethernet, Intel 82566MM Nineveh (PHY), PCIe x1, PXE											
Intel AMT	Intel Active Management Technology (AMT)											
Audio support	High Definition (HD) Audio, AD1984 codec / mono speaker, 0.5 watt / volume up, down, mute buttons / internal microphone, mic input jack (pink), headphone jack (green)											
Security	Power-on password, hard disk password, supervisor password, security keyhole											
Security chip	Trusted Platform Module, Atmel chip, TCG 1.2-compliant											
Fingerprint reader	<i>Some:</i> Fingerprint reader on palm rest, swipe sensor, supports the security chip											
Limited warranty ¹²	3-years/1-yr battery - EasyServ™ ¹⁹ depot repair service / service upgrades ²² available											
2GB PC2-5300 DDR2 SODIMM	40Y7735			ThinkPad X60 High Capacity 8-cell			40Y7003					
128GB SSD SATA 3.0Gb/s 1.8" (2.5" cover)	43N3406			ThinkPad X60 Extended Life Battery			40Y7005					
ThinkPad X6 UltraBase	40Y8116			ThinkPlus™.22 2-year LOR 9x5 NBD			41C9175					
Other accessories on O-X60 sheet											Other accessories at lenovo.com/accessories	

See footnotes for important warranty information

* Intel Centrino® processor technology

© Lenovo

☞ US model announced February 19, 2008;

* Intel Centrino with vPro™ technology

(SM3-2) February 2008

previous models on May 31, October 30, 2007, or January 8, 2008

☞ US models withdrawn effective January or May 2008

ThinkPad® X61s (7669) - TopSeller

Type-model	Low Voltage proc-essor	GHz	Memory	Display	Disk SATA GB ⁸ rpm	Optical in UltraBase	ThinkPad X6 UltraBase	Mini PCIe 802.11 wireless	Mini PCIe WWAN or Turbo	Finger-print reader	Bat-tery cells	Vista preload	Avail date
7669-45U	L7500 LV	1.60	2GB	12.1" XGA	100G 7200	DVD±RW	UltraBase	* Intel 11a/b/g ³²	Verizon	Finger 8-cell	8-cell	Ultimate 32	Jun 07
7669-7DU	L7300 LV	1.40	1GB	12.1" UL XGA	80GB 5400		UltraBase	* Intel 11a/b/g		Finger Slim-4	4-cell	Business 32	Jun 07
7669-88U	L7500 LV	1.60	2GB	12.1" UL XGA	160G 5400	DVD±RW	UltraBase	* Intel 11a/b/g		Finger 8-cell	8-cell	Business 64	Jun 07
7669-85U	L7500 LV	1.60	1GB	12.1" UL XGA	120G 5400		UltraBase	* Intel 11a/b/g		Finger 8-cell	8-cell	Home Basic 32	Jun 07
7669-3GU	L7500 LV	1.60	2GB	12.1" XGA	160G 7200	DVD±RW	UltraBase	* Intel 11n ²⁸	1G Turbo	Finger 8-cell	8-cell	Business 32	Sep 07
7669-3HU	L7500 LV	1.60	1GB	12.1" XGA	100G 7200		UltraBase	* Intel 11n		Finger 8-cell	8-cell	Business 32	Sep 07

• These small and medium business (SMB) models are part of the US TopSeller™ Program
 • These models have a 3-year limited warranty¹²

Positioning	<i>Thinnest and lightest; one spindle</i>	Preloaded operating system²⁰ - Some: Microsoft® Windows® Vista™ Home Basic Edition (32-bit) - Some: Microsoft Windows Vista™ Business Edition (32-bit) - Some: Microsoft Windows Vista Business Edition (64-bit) - Some: Microsoft Windows Vista Ultimate Edition (32-bit) ♦ 7DU/85U/3HU: Vista Basic logo ♦ 45U/88U/3GU: Vista Premium logo Preloaded applications¹⁴ (all OSes; only some listed) • Rescue and Recovery™ • Access Connections™ • Client Security Solution™ • ThinkVantage Productivity Center • ThinkVantage System Update • System Migration Assistant • Norton Internet Security™ • Diskeeper® Home • PC-Doctor™ (diagnostics) • Fingerprint Software • Microsoft Office 2007 Trial (60-day) • Sonic RecordNow and Drive Letter Access (DVD±RW) • Corel® WinDVD® (DVD±RW)	
Processor	Intel® Core™ 2 Duo processor L7300 or L7500 with low voltage, dual-core, Intel 64 Technology, Enhanced Intel SpeedStep® technology ¹ , Intel Dynamic Acceleration, Execute Disable Bit, Virtualization Technology, 800MHz system bus, and 4MB shared L2 cache		
Memory	1GB or 2GB std / 4GB max ⁷ / PC2-5300 667MHz DDR2, non-parity, dual-channel capable, two 200-pin SO-DIMM sockets; <i>Italics:</i> standard memory in both sockets; no sockets available; <i>Non-italics:</i> standard memory in one socket; one socket available		
Diskette drive	None (use optional USB-based diskette drive)		
EIDE DVD±RW	Some: DVD burner, Super Multi-Burner (40Y8623), dual-layer, removable from X6		
Ultrabay™ Slim	Supports Ultrabay Slim devices in optional or standard X6 UltraBase		
Serial ATA disk	80GB ⁸ (5400 rpm), 100GB (7200 rpm), 120GB (5400), or 160GB (5400 or 7200 rpm) / SATA 1.5Gb/s, 9.5mm high, removable, upgradable, supports 2nd disk in std or optional X6 UltraBase, ThinkPad Shock Mounted Hard Drive, Active Protection System™		
Display	Some: 12.1" (308mm) XGA (1024x768) TFT color, anti-glare, 150 nits Some: [UL] 12.1" (308mm) UltraLight XGA (1024x768) TFT color, anti-glare, 180 nits All: 4:3 aspect ratio, 300:1 contrast ratio		
Graphics controller	Intel Graphics Media Accelerator X3100 (GMA X3100), integrated in GM965		
Graphics - external	External VGA monitor support via analog DB-15 connector / no DVI-out support		
Keyboard	89-key, ThinkVantage button, spill-resistant, multimedia Fn keys, Windows/Appl keys, standard-size ²⁶ keys 97% size of T Series, 18.5mm pitch, 2.5mm stroke		
TrackPoint®	TrackPoint® pointing device, "Press-to-Select," Internet Scroll Bar ¹³ , magnifying glass		
Touch pad	None		
ThinkLight™	Illuminates the keyboard to improve visibility in low-light conditions		
Dimensions ³	without X6 UltraBase: Slim 4-cell: 10.5" x 8.3" x 0.8-1.1"; 268mm x 211mm x 20-28mm without X6 UltraBase: Enh 4-cell: 10.5" x 8.3" x 0.8-1.1"; 268mm x 211mm x 20-35mm without X6 UltraBase: 8-cell: 10.5" x 9.4" x 0.8-1.4"; 268mm x 238mm x 20-35mm Slim 4-cell: from 2.73 lb (1.24kg); Enh 4-cell: from 2.83 (1.28kg); 8-cell: 3.30 lb (1.50kg)		
Weight ²	Color: black; All: magnesium alloy		
Case material	Lithium Ion Slim Line Battery 4-cell (prismatic) or Lithium Ion 8-cell; supports optional Extended Life Battery on base (for two batteries); supports optional Ultrabay Slim battery in optional X6 UltraBase (for two batteries)		
Battery - type	Slim 4-cell: up to 3.5 hr; 8-cell: up to 9.0 hr; 8-cell and Extended Life Battery: up to 12.5		
Battery - life ¹⁰			
Chipset	Mobile Intel GM965 Express Chipset (Graphics Memory Controller Hub); ICH8M-Enhanced I/O Controller Hub (SATA 3.0Gb/s, ATA-100 EIDE, PCI Express® x1, PCI bus, USB, LPC bus, [Bluetooth], [fingerprint]) / PCI bus (Ricoh® R5C847 Cardbus/1394/Multicard) / LPC bus (PC87385 Super I/O, Atmel® 97SC3203 TPM)		
Media slice	Some: X6 UltraBase media slice (see right side)		
Secure Digital slot	One Secure Digital Card slot, supports SD memory cards used in consumer devices		
PC Card	One slot (Type I, Type II), CardBus Plus (34mm ExpressCard via adapter), door		
Ports	Three USB 2.0, DB-15 (external VGA monitor), RJ-11 (modem), RJ-45 (ethernet), IEEE 1394 FireWire 400 (4-pin connector; 1394a-2000 standard)		
Wireless antenna	UltraConnect™ II Antenna / on-off switch for all wireless radios		
Mini PCI Express	Two Mini PCI Express slots / only 802.11 wireless is customer upgradable		
Intel 11a/b/g ³²	Some: 11a/b/g wireless ⁴ , Mini PCIe adapter, Intel PRO/Wireless 3945ABG		
Intel 11n ²⁸	Some: 11a/b/g/n wireless ⁴ , Mini PCIe adapter, Intel Wireless WiFi Link 4965AGN, MIMO 2x3 (Kedron)		
Verizon ¹⁶	Some: Wireless WAN, Sierra Wireless 1xEV-DO Network Adapter, Mini PCIe adapter, EV-DO Rev. A, rod antenna, service contract reqd with Verizon® Wireless		
1G Turbo	Some: Intel Turbo Memory, Mini PCIe adapter, 1GB flash, disk-cache accelerator		
Modem	56K V.92 ⁵ modem in Communications Daughter Card		
Bluetooth™	Bluetooth 2.0 wireless, USB 2.0 interface via ICH8M, LED indicator		
Ethernet	Gigabit ethernet, Intel 82566MM Nineveh (PHY), PCIe x1, PXE		
Intel AMT	Intel Active Management Technology (iAMT)		
Audio support	High Definition (HD) Audio, AD1984 codec / mono speaker, 0.5 watt / volume up, down, mute buttons / internal microphone, mic input jack (pink), headphone jack (green)		
Security	Power-on password, hard disk password, supervisor password, security keyhole		
Security chip	Trusted Platform Module, Atmel chip, TCG 1.2-compliant		
Fingerprint reader	Fingerprint reader on palm rest, swipe sensor, supports the security chip		
Limited warranty ¹²	3-years/1-yr battery - EasyServ™ ¹⁹ depot repair service / service upgrades ²² available		
1GB PC2-5300 DDR2 SODIMM (TopSeller)	43R1999	X60 Slim Line Battery 4-cell (prismatic)	40Y6999
2GB PC2-5300 DDR2 SODIMM (TopSeller)	43R2000	X60 Enhanced Capacity Battery 4-cell	40Y7001
128GB SSD SATA 3.0Gb/s 1.8" (2.5" cover)	43N3406	ThinkPad X60 High Capacity 8-cell	40Y7003
ThinkPad X6 UltraBase	40Y8116	ThinkPad X60 Extended Life Battery	40Y7005

Other features:
 • Stereo speakers (1 watt)
 • Security key lock, security keyhole, and optional security screw
 • Serial and parallel ports
 • Analog VGA monitor port (no DVI)
 • Four USB 2.0 ports
 • Gigabit ethernet port
 • Modem port
 • Microphone in and headphone out
 • Requires 65 or 90 watt AC adapter
 • Retractable feet; 1.48 lb; 670g
 65-watt (GMA graphics) AC Adapter ENERGY STAR® 4.0-compliant RoHS-compliant International Warranty Service¹⁷ 24 hour x 7 day¹⁸ toll-free support during the warranty period¹² via 800-426-7378

See footnotes for important warranty information

US models announced September 4, 2007; previous models on May 31, 2007

US models withdrawn effective August 2007

* Intel Centrino® processor technology

* Intel Centrino with vPro™ technology

© Lenovo

(KB3-1) September 2007

ThinkPad® X61s (7666)

Type-model	Low Voltage proc- essor	GHz	Memory	Display	Disk SATA GB ³	Optical in UltraBase	ThinkPad UltraBase	Mini PCIe 802.11 wireless	Mini PCIe WWAN or Turbo	Finger Bat- print tery reader cells	Workhorse (W) Global (G)	Avail date
7666-34U	L7500	1.60	1GB	12.1" XGA	80GB 5400			*Intel 4965AG ³²		Finger 8	Business 32 W G	Jun 07
7666-36U	L7500	1.60	1GB	12.1" XGA	120G 5400			*Intel 4965AG		Finger 8	Business 32 W G	Jun 07
7666-47U	L7500	1.60	1GB	12.1" XGA	160G 5400			*Intel 11a/b/g ³²	Verizon	Finger 8	Business 32 W	Jun 07
7666-76U	L7300	1.40	512M	12.1" UL XGA	80GB 5400			*Intel 11a/b/g		Finger 4	Business 32	Jun 07
7666-54U	L7500	1.60	1GB	12.1" XGA	80GB 5400			*Intel 11n ²⁸		Finger 8	Business 64	Jun 07
7666-43U	L7500	1.60	1GB	12.1" XGA	120G 5400	DVD±RW	UltraBase	*Intel 11a/b/g	AT&T	Finger 8	Ultimate 32	Jun 07
7666-3FU	L7500	1.60	1GB	12.1" XGA	80GB 5400			*Intel 4965AG		Finger 8	XP Pro W G	Jun 07
7666-3EU	L7500	1.60	1GB	12.1" XGA	120G 5400			*Intel 4965AG		Finger 8	XP Pro W G	Jun 07
7666-B7U	L7700	1.80	2GB	12.1" XGA	100G 7200			*Intel 4965AG		Finger 8	Business 32 W	Oct 07
7666-8LU	L7500	1.60	2GB	12.1" XGA	160G 7200			*Intel 4965AG	1G Turbo	Finger 8	Business 32 W	Oct 07
7666-48U	L7500	1.60	1GB	12.1" XGA	120G 5400			*Intel 4965AG	WWAN upg	Finger 8	Business 32 W	Feb 08
Processor	Intel® Core™ 2 Duo processor L7300, L7500, or L7700 with low voltage, dual-core, Intel 64 Technology, Enhanced Intel SpeedStep® technology ¹ , Intel Dynamic Acceleration, Execute Disable Bit, Virtualization Technology, 800MHz system bus, and 4MB shared L2 cache											
Memory	512MB, 1GB, or 2GB std / 4GB max ⁷ / PC2-5300 667MHz DDR2, non-parity, dual-channel capable, two 200-pin SO-DIMM sockets; <i>Italics:</i> standard memory in both sockets; no sockets available; <i>Non-italics:</i> standard memory in 1 socket; 1 socket available											
Diskette drive	None (use optional USB-based diskette drive)											
EIDE DVD±RW	<i>Some:</i> DVD burner, Super Multi-Burner (40Y8623), dual-layer, removable from X6											
Ultrabay™ Slim	Supports Ultrabay Slim devices in optional or standard X6 UltraBase											
Serial ATA disk	80GB ⁸ (5400 rpm), 100GB (7200 rpm), 120GB (5400), or 160GB (5400 or 7200 rpm) / SATA 1.5Gb/s, 9.5mm high, removable, upgradable, supports 2nd disk in std or optional X6 UltraBase, ThinkPad Shock Mounted Hard Drive, Active Protection System™											
Display	<i>Some:</i> 12.1" (308mm) XGA (1024x768) TFT color, anti-glare, 150 nits <i>Some:</i> [UL] 12.1" (308mm) UltraLight XGA (1024x768) TFT color, anti-glare, 180 nits <i>All:</i> 4:3 aspect ratio, 300:1 contrast ratio											
Graphics controller	Intel Graphics Media Accelerator X3100 (GMA X3100), integrated in GM965											
Graphics - external	External VGA monitor support via analog DB-15 connector / no DVI-out support											
Keyboard	89-key, ThinkVantage button, spill-resistant, multimedia Fn keys, Windows/Appl keys, standard-size ²⁶ keys 97% size of T Series, 18.5mm pitch, 2.5mm stroke											
TrackPoint®	TrackPoint® pointing device, "Press-to-Select," Internet Scroll Bar ¹³ , magnifying glass											
Touch pad	None											
ThinkLight™	Illuminates the keyboard to improve visibility in low-light conditions											
Dimensions ³	<i>without X6 UltraBase: Slim 4-cell:</i> 10.5" x 8.3" x 0.8-1.1"; 268mm x 211mm x 20-28mm <i>without X6 UltraBase: Enh 4-cell:</i> 10.5" x 8.3" x 0.8-1.1"; 268mm x 211mm x 20-35mm <i>without X6 UltraBase: 8-cell:</i> 10.5" x 9.4" x 0.8-1.4"; 268mm x 238mm x 20-35mm <i>Slim 4-cell:</i> from 2.73 lb (1.24kg); <i>Enh 4-cell:</i> from 2.83 (1.28kg); <i>8-cell:</i> 3.30 lb (1.50kg) <i>Color:</i> black; <i>All:</i> magnesium alloy											
Weight ²												
Case material	Lithium Ion Slim Line Battery 4-cell (prismatic) or Lithium Ion 8-cell;											
Battery - type	supports optional Extended Life Battery on base (for two batteries); supports optional Ultrabay Slim device in optional X6 UltraBase (for two batteries)											
Battery - life ¹⁰	<i>Slim 4-cell:</i> up to 3.5 hr; <i>8-cell:</i> up to 9.0 hr; <i>8-cell and Extended Life Battery:</i> up to 12.5											
Chipset	Mobile Intel GM965 Express Chipset (Graphics Memory Controller Hub); ICH8M-Enhanced I/O Controller Hub (SATA 3.0Gb/s, ATA-100 EIDE, PCI Express ⁹ x1, PCI bus, USB, LPC bus, [Bluetooth], [fingerprint]) / PCI bus (Ricoh® R5C847 Cardbus/1394/Multicard) / LPC bus (PC87385 Super I/O, Atmel® 97SC3203 TPM)											
Media slice	<i>Some:</i> X6 UltraBase media slice (see right side)											
Secure Digital slot	One Secure Digital Card slot, supports SD memory cards used in consumer devices											
PC Card slot	One Type I or one Type II, CardBus Plus (34mm ExpressCard via adapter), door											
Ports	Three USB 2.0, DB-15 (external VGA monitor), RJ-11 (modem), RJ-45 (ethernet), IEEE 1394 FireWire 400 (4-pin connector; 1394a-2000 standard)											
Wireless antenna	UltraConnect™ II Antenna / on-off switch for all wireless radios											
Mini PCI Express	Two Mini PCI Express slots											
Intel 11a/b/g ³²	<i>Some:</i> 11a/b/g wireless ⁴ , Mini PCIe adapter, Intel PRO/Wireless 3945ABG											
Intel 4965AG ³²	<i>Some:</i> 11a/b/g wireless ⁴ , Mini PCIe adapter, Intel Wireless WiFi Link 4965AG											
Intel 11n ²⁸	<i>Some:</i> 11a/b/g/n wireless ⁴ , Mini PCIe adapter, Intel Wireless WiFi Link 4965AGN, MIMO 2x3 (Kedron)											
WWAN upg	<i>Some:</i> Wireless WAN upgradable, requires Verizon® EV-DO Rev. A Mini PCIe (43R1818)											
Verizon ¹⁶	<i>Some:</i> Wireless WAN, Sierra Wireless 1xEV-DO Network Adapter, Mini PCIe adapter, EV-DO Rev. A, rod antenna, service contract reqd with Verizon											
AT&T ²³	<i>Some:</i> Wireless WAN, GPRS/EDGE/UMTS/HSDPA support, Mini PCIe adapter and SIM, rod antenna, service contract reqd with AT&T®											
1G Turbo	<i>Some:</i> Intel Turbo Memory, Mini PCIe adapter, 1GB flash, disk-cache accelerator											
Modem	56K V.92 ⁵ modem in Communications Daughter Card											
Bluetooth™	Bluetooth 2.0 wireless, USB 2.0 interface via ICH8M, LED indicator											
Ethernet	Gigabit ethernet, Intel 82566MM Nineveh (PHY), PCIe x1, PXE											
Intel AMT	Intel Active Management Technology (IAMT)											
Audio support	High Definition (HD) Audio, AD1984 codec / mono speaker, 0.5 watt / volume up, down, mute buttons / internal microphone, mic input jack (pink), headphone jack (green)											
Security	Power-on password, hard disk password, supervisor password, security keyhole											
Security chip	Trusted Platform Module, Atmel chip, TCG 1.2-compliant											
Fingerprint reader	<i>Some:</i> Fingerprint reader on palm rest, swipe sensor, supports the security chip											
Limited warranty ¹²	3-years/1-yr battery - EasyServ™ ¹⁹ depot repair service / service upgrades ²² available											

Preloaded operating system²⁰
 - *Some:* Microsoft® Windows® XP Professional
 - *Some:* Microsoft Windows Vista™ Business Edition (32-bit)
 - *Some:* Microsoft Windows Vista Business Edition (64-bit)
 - *Some:* Microsoft Windows Vista Ultimate Edition (32-bit)
 ✧ 2GB models: Vista Premium logo
 ✧ Other Vista models: Vista Basic logo

Preloaded applications¹⁴ (all OSes; only some listed)
 • Rescue and Recovery™
 • Access Connections™
 • Client Security Solution™
 • ThinkVantage Productivity Center
 • Norton Internet Security™
 • Diskeeper® Home
 • PC-Doctor™ (diagnostics)
 • *Some:* Fingerprint Software
 • Microsoft Office 2007 Trial (60-day)
 • Sonic RecordNow and Drive Letter Access (DVD±RW)
 • Corel® WinDVD® (DVD±RW)

Supports ThinkVantage® technologies

ThinkPad X6 UltraBase™

- Provides desktop expansion and cable management for X60 Series
- Easily connects to the bottom of the X60 Series for traveling
- Converts ThinkPad to a two-spindle system with optional flat bezel

Ultrabay Slim options in left side:
 - ThinkPad Advanced Ultrabay Battery II 3-cell (flat) 43R9250
 - ThinkPad DVD Ultrabay Slim Burner (flat bezel) 41N5643
 - Serial Hard Drive Ultrabay Slim Adapter (flat bezel) 40Y8725

Disks supported:
 • 200GB FDE 7200 rpm 41N5738
 • 320GB Disk 5400 rpm 43N3403

Other features:

- Stereo speakers (1 watt)
- Security key lock, security keyhole, and optional security screw
- Serial and parallel ports
- Analog VGA monitor port (no DVI)
- Four USB 2.0 ports
- Gigabit ethernet port
- Modem port
- Microphone in and headphone out
- Requires 65 or 90 watt AC adapter
- Retractable feet; 1.48 lb; 670g

65-watt (GMA graphics) AC Adapter ENERGY STAR® 4.0-compliant RoHS-compliant International Warranty Service¹⁷ 24 hour x 7 day¹⁸ toll-free support during the warranty period¹² via 800-426-7378

See footnotes for important warranty information

* Intel Centrino® processor technology

Ⓜ US model announced February 19, 2008; previous models on May 31 or October 30, 2007

* Intel Centrino with vPro™ technology

Ⓜ US models withdrawn effective Sept 2007, Jan 2008, or May 2008

ThinkPad® X61s (7667) - Onsite

Type-model	Low Voltage proc- essor	GHz	Memory	Display	Disk SATA GB ⁸ rpm	Optical in UltraBase	ThinkPad X6 UltraBase	Mini PCIe 802.11 wireless	Mini PCIe WWAN or Turbo	Finger Bat- tery reader cells	Preload	Workhorse (W) Global (G) GMP (P)	Avail date
7667-34U	L7500	1.60	1GB	12.1" XGA	80GB 5400	Optional	Optional	* Intel 4965AG ³²	None	Finger	8 Business	W G P	Jun 07
7667-36U	L7500	1.60	1GB	12.1" XGA	120G 5400	Optional	Optional	* Intel 4965AG	None	Finger	8 Business	W G P	Jun 07
7667-3FU	L7500	1.60	1GB	12.1" XGA	80GB 5400	Optional	Optional	* Intel 4965AG	None	8 XP Pro		W G P	Jun 07
7667-3EU	L7500	1.60	1GB	12.1" XGA	120G 5400	Optional	Optional	* Intel 4965AG	None	8 XP Pro		W G P	Jun 07

• These models are part of the Global Models Plus program with limited onsite service²⁴ 3-year limited warranty

Processor	Intel® Core™ 2 Duo processor L7500 with low voltage, dual-core, Intel 64 Technology, Enhanced Intel SpeedStep® technology ¹ , Intel Dynamic Acceleration, Execute Disable Bit, Virtualization Technology, 800MHz system bus, and 4MB shared L2 cache										Preloaded operating system²⁰ - Some: Microsoft® Windows® XP Professional - Some: Microsoft Windows Vista® Business Edition (32-bit) ◇ Vista models: Vista Basic logo		
Memory	1GB std / 4GB max ⁷ / PC2-5300 667MHz DDR2, non-parity, dual-channel capable, two 200-pin SO-DIMM sockets; <i>Non-italics:</i> standard memory in 1 socket; 1 socket available										Preloaded applications¹⁴ (all OSes; only some listed) • Rescue and Recovery™ • Access Connections™ • Client Security Solution™ • ThinkVantage Productivity Center • Norton Internet Security™ (90 days of virus definitions) • Diskeeper® Home • PC-Doctor™ (diagnostics) • ThinkPad Utilities (Power Manager and Presentation Director) • Some: Fingerprint Software • Microsoft Office 2007 Trial (60-day)		
Diskette drive EIDE DVD±RW Ultrabay™ Slim Serial ATA disk	None (use optional USB-based diskette drive) Option for <i>ThinkPad X6 Tablet UltraBase</i> Supports Ultrabay Slim devices in optional <i>X6 UltraBase</i> 80GB⁸ (5400 rpm), 120GB (5400) / SATA 1.5Gb/s, 9.5mm high, removable, upgradable, supports 2nd disk in std or optional <i>X6 UltraBase</i> , ThinkPad Shock Mounted Hard Drive, Active Protection System™												
Display	12.1" (308mm) XGA (1024x768) TFT color , anti-glare, 150 nits, 4:3 aspect ratio, 300:1 contrast ratio												
Graphics controller Graphics - external	Intel Graphics Media Accelerator X3100 (GMA X3100) , integrated in GM965 External VGA monitor support via analog DB-15 connector / no DVI-out support												
Keyboard	89-key, ThinkVantage button, spill-resistant, multimedia Fn keys, Windows/Appl keys, standard-size ²⁶ keys 97% size of T Series, 18.5mm pitch, 2.5mm stroke												
TrackPoint® Touch pad ThinkLight™	TrackPoint® pointing device, "Press-to-Select," Internet Scroll Bar ¹³ , magnifying glass None Illuminates the keyboard to improve visibility in low-light conditions												
Dimensions ³	<i>without X6 UltraBase: Slim 4-cell:</i> 10.5" x 8.3" x 0.8-1.1"; 268mm x 211mm x 20-28mm <i>without X6 UltraBase: Enh 4-cell:</i> 10.5" x 8.3" x 0.8-1.1"; 268mm x 211mm x 20-35mm <i>without X6 UltraBase: 8-cell:</i> 10.5" x 9.4" x 0.8-1.4"; 268mm x 238mm x 20-35mm <i>Slim 4-cell:</i> from 2.73 lb (1.24kg); <i>Enh 4-cell:</i> from 2.83 (1.28kg); <i>8-cell:</i> 3.30 lb (1.50kg) <i>Color:</i> black; <i>All:</i> magnesium alloy										Supports ThinkVantage® technologies		
Weight ² Case material Battery - type	Lithium Ion 8-cell ; supports optional Extended Life Battery on base (for two batteries); supports optional Ultrabay Slim battery in optional X6 UltraBase (for two batteries)										ThinkPad X6 UltraBase™ • Provides desktop expansion and cable management for X60 Series • Easily connects to the bottom of the X60 Series for traveling • Converts ThinkPad to a two-spindle system with optional flat bezel Ultrabay Slim options in left side: – ThinkPad Advanced Ultrabay Battery II 3-cell (flat) 43R9250 – ThinkPad DVD Ultrabay Slim Burner (flat bezel) 41N5643 – Serial Hard Drive Ultrabay Slim Adapter (flat bezel) 40Y8725 Disks supported: • 200GB FDE 7200 rpm 41N5738 • 320GB Disk 5400 rpm 43N3403		
Battery - life ¹⁰	<i>Slim 4-cell:</i> up to 3.5 hr; <i>8-cell:</i> up to 9.0 hr; <i>8-cell and Extended Life Battery:</i> up to 12.5												
Chipset	Mobile Intel GM965 Express Chipset (Graphics Memory Controller Hub); ICH8M-Enhanced I/O Controller Hub (SATA 3.0Gb/s, ATA-100 EIDE, PCI Express® x1, PCI bus, USB, LPC bus, [Bluetooth], [fingerprint]) / PCI bus (Ricoh® R5C847 Cardbus/1394/Multicard) / LPC bus (PC87385 Super I/O, Atmel® 975C3203 TPM)												
Media slice Secure Digital slot PC Card slot Ports	<i>Option: ThinkPad X6 UltraBase media slice</i> (see right side) One Secure Digital Card slot, supports SD memory cards used in consumer devices One Type I or one Type II, CardBus Plus (34mm ExpressCard via adapter), door Three USB 2.0, DB-15 (external VGA monitor), -RJ-11 (modem), RJ-45 (ethernet), IEEE 1394 FireWire 400 (4-pin connector; 1394a-2000 standard)										Other features: • Stereo speakers (1 watt) • Security key lock, security keyhole, and optional security screw • Serial and parallel ports • Analog VGA monitor port (no DVI) • Four USB 2.0 ports • Gigabit ethernet port • Modem port • Microphone in and headphone out • Requires 65 or 90 watt AC adapter • Retractable feet; 1.48 lb; 670g		
Wireless antenna Mini PCI Express Intel 4965AG ³² WWAN Turbo 1G Modem Bluetooth™ Ethernet Intel AMT Audio support	UltraConnect™ II Antenna / on-off switch for all wireless radios Two Mini PCI Express slots / only 802.11 wireless is customer upgradable 11a/b/g wireless ⁴ , Mini PCIe adapter, Intel Wireless WiFi Link 4965AG None None 56K V.92 ⁹ modem in Communications Daughter Card Bluetooth 2.0 wireless, USB 2.0 interface via ICH8M, LED indicator Gigabit ethernet, Intel 82566MM Nineveh (PHY), PCIe x1, PXE Intel Active Management Technology (IAMT) High Definition (HD) Audio, AD1984 codec / mono speaker 0.5 watt / volume up, down, mute buttons / internal microphone, mic input jack (pink), headphone jack (green)												
Security Security chip Fingerprint reader	Power-on password, hard disk password, supervisor password, security keyhole Trusted Platform Module , Atmel chip, TCG 1.2-compliant <i>Some:</i> Fingerprint reader on palm rest , swipe sensor, supports the security chip										65-watt (GMA graphics) AC Adapter ENERGY STAR® 4.0-compliant ROHS-compliant International Warranty Service ¹⁷ 24 hour x 7 day ¹⁸ toll-free support during the warranty period ¹² via 800-426-7378		
Limited warranty ¹²	3-years /1-year battery, limited onsite service²⁴ , 8 am - 5 pm, Mon - Fri coverage excluding holidays, next business day response time / service upgrades ²² available												
ThinkPlus™.22 4-year LOR ²⁴ 9x5 NBD ThinkPlus 5-year LOR 9x5 NBD	12X5630 43R2162				Post-warranty annual maintenance agreements at lenovo.com/thinkplus/warranty								

See footnotes for important warranty information
US models announced May 31, 2007

* Intel Centrino® with vPro™ technology

© Lenovo
(KB3-3) February 2008

⚡ US models withdrawn effective May 2008

Partial list of accessories supported on:

- ThinkPad X60 originally announced January 5, 2006
- ThinkPad X60s originally announced January 5, 2006
- ThinkPad X61 originally announced May 31, 2007
- ThinkPad X61s originally announced May 31, 2007

Memory

512MB PC2-5300 DDR2 SODIMM	40Y7733	ann 01/05/06
1GB PC2-5300 DDR2 SODIMM (TopSeller)	43R1999	ann 03/25/08
1GB PC2-5300 DDR2 SODIMM	40Y7734	ann 01/05/06
2GB PC2-5300 DDR2 SODIMM (TopSeller)	43R2000	ann 03/25/08
2GB PC2-5300 DDR2 SODIMM	40Y7735	ann 11/28/06

Ultrabay Slim 9.5mm (best to use flat bezel options)

Most Ultrabay Slim options supported in X6 Ultrabase

Ultrabay Enhanced 12.7mm

None

Storage and removable storage

160GB Disk SATA 1.5Gb/s (5400 rpm) ⁴¹	41N5692	ann 03/20/07
160GB Disk SATA 1.5Gb/s (7200 rpm) ⁴¹	41N5737	ann 10/16/07
250GB Disk SATA 1.5Gb/s (5400 rpm) ⁴¹	43R8152	ann 01/15/08
320GB Disk SATA 1.5Gb/s (5400 rpm) ⁴¹	43N3403	ann 08/05/08

⁴¹ Can be used as the main disk or with

ThinkPad Serial ATA Hard Drive Ultrabay Slim

Adapter 40Y8725 in the optional ThinkPad X6 Ultrabase 40Y8116.

USB 2.0 Essential Memory Key 2GB	41U4944	ann 01/23/07
USB 2.0 Essential Memory Key 4GB	45J7904	ann 06/24/08
USB 2.0 Essential Memory Key 8GB	45J7905	ann 07/15/08
USB 2.0 Essential Memory Key 32GB	45K1258	ann 10/28/08
USB 2.0 Security Memory Key 2GB	41U5119	ann 07/17/07
USB 2.0 Security Memory Key 4GB	41U5120	ann 07/17/07
USB 2.0 Ultra Secure Memory Key 2GB	45J5916	ann 08/26/08
USB 2.0 Ultra Secure Memory Key 4GB	45J5917	ann 08/26/08
USB 2.0 Ultra Secure Memory Key 8GB	45J5918	ann 08/26/08

USB Portable Diskette Drive	05K9276	ann 06/05/00
USB 2.0 CD-RW/DVD-ROM Combo II Drive	40Y8637	ann 01/05/06
USB 2.0 Portable 160GB Hard Disk	43R1784	ann 09/23/08
USB 2.0 Portable Secure 160GB Hard Disk	43R2018	ann 11/18/08
USB 2.0 Portable Secure 320GB Hard Disk	43R2019	ann 11/18/08
USB 2.0 Super Multi-Burner Drive	41N5565	ann 01/23/07

Wireless WAN (Mini PCI Express)

Only 7673-5GU, 7675-4NU, 7666-36U, and 7666-48U models:

Verizon WWAN EV-DO Rev. A Mini PCIe	43R1818	ann 03/04/08
-------------------------------------	---------	--------------

ThinkPad Expansion

USB 2.0 Lenovo Enhanced Port Replicator	43R8770	ann 02/26/08
ThinkPad Adjustable Notebook Stand	40Y7676	ann 09/20/05
ThinkPad X6 UltraBase	40Y8116	ann 01/05/06

Keyboard

TrackPoint Cap Collection	73P2698	ann 12/16/03
USB Numeric Keypad	33L3225	ann 05/01/00
Preferred Pro USB Keyboard	73P5220	ann 06/21/05
Enhanced Performance USB Keyboard	73P2620	ann 03/23/04
Wireless Kybd & Opt Wheel Mouse (via USB)	73P4067	ann 12/07/04
USB Keyboard with UltraNav	31P8950	ann 01/28/03
USB Travel Keyboard with UltraNav	31P9490	ann 04/27/04
Lenovo USB Fingerprint Keyboard	73P4730	ann 02/22/05

Mouse

Optical Wheel Mouse (USB)	06P4069	ann 05/21/03
Optical ScrollPoint® Mouse (USB, PS/2)	31P7405	ann 08/27/02
Optical Wheel Travel Mouse (USB, PS/2)	31P7410	ann 06/04/02
Laser Tilt Wheel Mouse (USB, PS/2)	41U3074	ann 01/23/07
Lenovo Wireless Laser Mouse (blk, via USB)	45K1696	ann 11/25/08
Lenovo Wireless Laser Mouse (red, via USB)	51J0198	ann 11/25/08
Laser Tilt Wheel Travel Mouse (Bluetooth)	41U5008	ann 01/22/08
Wireless Kybd & Opt Wheel Mouse (via USB)	73P4067	ann 12/07/04

Security

Kensington® Cable Lock from Lenovo	73P2582	ann 12/29/03
Kensington Twin Head Cable Lock	45K1620	ann 09/30/08
USB Gemplus GemPC Smart Card Reader	41N3040	ann 02/21/06
PC Card Gemplus Smart Card Reader	41N3004	ann 12/13/05

Multimedia

USB 2.0 Lenovo Multimedia Headset	40Y8518	ann 06/27/06
USB 2.0 Lenovo Webcam	40Y8519	ann 08/29/06

Batteries

X60s only:

X60 Slim Line Battery 4-cell (prismatic)	40Y6999	ann 01/05/06
--	---------	--------------

All models:

X60 Enhanced Cap Battery 4-cell (cylindric)	40Y7001	ann 01/05/06
X60 High Capacity 8-cell (cylindrical)	40Y7003	ann 01/05/06
X60 Extended Life Battery	40Y7005	ann 01/05/06
ThinkPad External Battery Charger ⁴⁴	40Y7625	ann 09/20/05

⁴⁴ Requires the ThinkPad 90W AC Adapter

40Y7659 (adapter provided with some systems).

ThinkPad 65W AC Adapter	40Y7696	ann 09/20/05
ThinkPad 90W AC Adapter	40Y7659	ann 09/20/05
ThinkPad 90W Slim AC/DC Combo Adapter	41N8460	ann 11/27/07
Belkin 1 Outlet Notebook Surge	31P7658	
Belkin Universal Notebook Travel Surge	22P7127	
Belkin Surge Protector	31P7659	

Carrying Cases

Up to 13.3" widescreen models:

ThinkPad Ultraportable Case	41U5062	ann 05/13/08
-----------------------------	---------	--------------

Up to 14.1" widescreen models:

ThinkPad Expander Case	43R9118	ann 06/24/08
ThinkPad Women's Microfiber Tote	22P8855	
ThinkPad Women's Leather Trim Tote	22P8856	
ThinkPad Convertible Carrying Case	22P8860	
ThinkPad Women's Executive Leather Tote	22P8857	
Women's Executive Red Leather Tote	22P8858	

Up to 15.4" widescreen models:

Lenovo Carrying Case - Messenger Max	41U5253	ann 05/01/07
Lenovo Carr Case - Performance Backpack	41U5254	ann 05/01/07
Lenovo Standard Case	45K1697	ann 11/25/08
Lenovo Standard Backpack	45K1698	ann 11/25/08
ThinkPad Business Topload Case	43R2476	ann 05/13/08
ThinkPad Business Backpack	43R2482	ann 05/13/08
ThinkPad Deluxe Expander Case	43R2478	ann 05/13/08
ThinkPad Executive Leather Case	43R2480	ann 05/13/08

Up to 17.0" widescreen models:

ThinkPad 17W Business Topload Case	43R9117	ann 08/12/08
------------------------------------	---------	--------------

Monitors

ThinkVision® L174 17" Monitor	9227AE1	ann 04/15/08
ThinkVision L1700p 17" Monitor	9417HE2	ann 09/17/08
ThinkVision L1900p 19" Monitor	4431HE1	ann 11/11/08
ThinkVision L1940p Wide 19" Monitor	4424HB6	ann 09/17/08
ThinkVision L200p Wide 20.1" Monitor	4438HB6	ann 04/15/08
ThinkVision L2240p Wide 22" Monitor	4422HB6	ann 09/17/08
ThinkVision L2440p Wide 24" Monitor	4420HB2	ann 09/17/08
ThinkVision L2440x Wide 24" Monitor	4421HB2	ann 09/17/08

Monitor Accessories⁴⁶

ThinkVision USB Soundbar	40Y7616	ann 08/23/05
ThinkVision Soundbar	45K1263	ann 09/16/08
ThinkPad Convertible Monitor Stand	40Y7620	ann 01/05/06
Radial Arm	19K4464	ann 05/05/00

⁴⁶ Compatible on selected Lenovo and ThinkVision monitors.

More information at www.lenovo.com/support/monitoraccessories

Other accessories at www.lenovo.com/accessories

Accessories Guide pdf at www.lenovo.com/accessoriesguide

Type-model	Low Voltage proc-esssor	GHz	Memory	Display	Disk SATA GB ^s rpm	Optical in UltraBase	X6 Tablet UltraBase	Mini PCIe 802.11 wireless	Mini PCIe WWAN or Turbo	Finger Bat-tery reader cells	Workhorse (W) Global (G) Avail date
7762-54U	L7500	1.60	1GB	12.1" XGA	80GB 5400			* Intel 4965AG ³²		Fing 8	Business32 W G Jun 07
7762-95U	L7500	1.60	1GB	12.1" SXGA+ SV	80GB 5400			* Intel 4965AG		Fing 8	Business32 W G Jun 07
7762-D6U	L7500	1.60	2GB	12.1" XGA Touch	160G 5400	DVD±RW	UltraBase	* Intel 11n ²⁸		Fing 8	Ultimate 32 Jun 07
7762-B6U	L7500	1.60	1GB	12.1" XGA Touch	120G 5400			* Intel 4965AG		Fing 8	Business32 W G Jun 07
7762-58U	L7500	1.60	2GB	12.1" XGA	120G 5400			* Intel 4965AG		Fing 8	Ultimate32 W G Jun 07
7762-44U	L7500	1.60	2GB	12.1" XGA	120G 5400	Combo	UltraBase			Fing 8	XP Tablet TAA Jun 07
7762-H7U	L7700	1.80	2GB	12.1" XGA	100G 7200			* Intel 11a/b/g ³²		Fing 8	Business32 W Oct 07
7762-98U	L7500	1.60	2GB	12.1" SXGA+ SV	160G 5400			* Intel 4965AG	1G Turbo	Fing 8	Business32 W Oct 07
7762-BEU	L7500	1.60	2GB	12.1" XGA Touch	160G 7200			* Intel 4965AG		Fing 8	Business32 W Oct 07
7762-99U	L7500	1.60	2GB	12.1" SXGA+ SV	120G 5400			* Intel 11a/b/g		Fing 8	XP Tablet TAA Nov 07
7762-63U	L7500	1.60	1GB	12.1" XGA	80GB 5400			* Intel 4965AG	WWAN upg	Fing 8	Business 32 Feb 08
7762-9CU	L7500	1.60	2GB	12.1" SXGA+ SV	120G 5400			* Intel 11a/b/g		Fing 8	Business 32 TAA Jun 08
US Govt (TAA) ⁵ Processor	44U/99U/9CU: US Government model (Trade Act Agreement-compliant) Intel® Core™ 2 Duo processor L7500 and L7700 with low voltage, dual-core , Intel 64 Technology, 800MHz system bus, and 4MB shared L2 cache										
Memory	1GB or 2GB std / 4GB max ⁷ / PC2-5300 667MHz DDR2, non-parity, dual-channel capable, two 200-pin SO-DIMM sockets; <i>Italics:</i> standard memory in both sockets; no sockets available; <i>Non-italics:</i> standard memory in one socket; one socket available										
Ultrabay™ Slim EIDE Combo Serial ATA disk	Supports Ultrabay Slim devices in optional or standard <i>ThinkPad X6 Tablet UltraBase</i> <i>Some:</i> DVD-ROM/CD-RW / 24X/24X/24X/8X ²¹ speed / removable from <i>X6 UltraBase</i> <i>Some:</i> DVD burner, Super Multi-Burner (40Y8623), dual-layer, removable from <i>X6 80GB⁸</i> (5400 rpm), 100GB (7200 rpm), 120GB , or 160GB (5400 or 7200 rpm) / SATA1.5Gb/s, 9.5mm high, removable, upgradable, supports 2nd disk in std or optional <i>X6 Tablet UltraBase</i> , ThinkPad Shock Mounted Hard Drive, Active Protection System™										
Display	<i>Some:</i> 12.1" (307mm) XGA (1024x768) TFT color, 185 nits, 4:3, 500:1, 170° viewing <i>Some:</i> 12.1" (307mm) SXGA+ (1400x1050) color, 190 nits, 4:3, 500:1, 170° viewing, direct bonding panel (SuperView) for improved outdoor viewability <i>Touch:</i> 12.1" (307mm) XGA (1024x768) TFT color, 4:3, 150 nits, 170° viewing / MultiView (indoor/outdoor), MultiTouch (touchscreen via finger and pen) <i>All:</i> Super Wide Angle FFS / anti-reflective and anti-glare protective coatings / write on screen with standard digitizer pen / pen holder in front base / rotate and swivel hinge in middle bottom of display for tablet mode (portrait or landscape) or picture frame mode (keyboard faces away from user) / buttons on display bottom (power, lock, reboot, rotation, utility, Esc, NavDial/enter)										
Graphics controller	Intel Graphics Media Accelerator X3100 (GMA X3100) , integrated in GM965 Graphics - external External VGA monitor support via analog DB-15 connector / no DVI-out support										
Keyboard TrackPoint®	89-key, ThinkVantage button, spill-resistant, multimedia Fn keys, 18.5mm pitch TrackPoint® pointing device, "Press-to-Select," Internet Scroll Bar ¹³ , magnifying glass										
Dimensions ³	<i>without X6 UltraBase:</i> 4-cell: 10.8" x 9.6" x 1.1-1.3"; 274mm x 244mm x 27.4-33.1mm <i>without X6 UltraBase:</i> 8-cell: 10.8" x 10.5" x 1.1-1.3"; 274mm x 267mm x 27.4-33.1mm 4-cell: starting at 3.77 lb (1.71kg); 8-cell: starting at 4.25 lb (1.93kg) <i>Color:</i> black; <i>All:</i> magnesium alloy										
Weight ² Case material Battery - type	Li-Ion 8-cell ; supports optional Extended Life Battery on base (for two batteries); supports optional Ultrabay Slim battery in optional <i>X6 Tablet UltraBase</i> (for 2 batteries)										
Battery - life ¹⁰	<i>with 4-cell:</i> up to 3.0 hr; <i>with 8-cell:</i> up to 7.0 hr; <i>8-cell and Ultrabay Slim:</i> up to 9.0 hr <i>with 8-cell and optional Extended Life Battery:</i> up to 9.5 hr										
Chipset	Mobile Intel GM965 Express Chipset (Graphics Memory Controller Hub); ICH8M-Enhanced I/O Controller Hub (SATA 3.0Gb/s, ATA-100 EIDE, PCI Express® x1, PCI bus, USB, LPC bus, [Bluetooth], [fingerprint]) / PCI bus (Ricoch® R5C847 Carbus/1394/Multicard) / LPC bus (PC87385 Super I/O, Atmel® 97SC3203 TPM)										
Media slice Secure Digital slot PC Card Ports	<i>Some:</i> ThinkPad X6 Tablet UltraBase (see right side) One Secure Digital Card slot, supports SD memory cards used in consumer devices One slot (Type I, Type II), CardBus Plus (34mm ExpressCard via adapter), door Three USB 2.0, DB-15 (external VGA monitor), RJ-11 (modem), RJ-45 (ethernet), IEEE 1394 FireWire 400 (4-pin connector; 1394a-2000 standard)										
Mini PCI Express Intel 11a/b/g ³² Intel 4965AG ³² Intel 11n ²⁸ WWAN upg 1G Turbo Modem Bluetooth™ Ethernet Intel AMT Audio support	Two Mini PCI Express slots <i>Some:</i> 11a/b/g wireless ⁴ , Mini PCI Express adapter, Intel PRO/Wireless 3945ABG <i>Some:</i> 11a/b/g wireless ⁴ , Mini PCIe adapter, Intel Wireless WiFi Link 4965AG <i>Some:</i> 11a/b/g/n wireless ⁴ , Mini PCIe adapter, Intel Wireless WiFi Link 4965AGN, MIMO 2x3 (Kedron) <i>Some:</i> Wireless WAN upgradable, requires Verizon® EV-DO Rev. A Mini PCIe (43R1818) <i>Some:</i> Intel Turbo Memory, Mini PCIe adapter, 1GB flash, disk-cache accelerator 56K V.92 ⁶ modem in Communications Daughter Card <i>All except 44U/99U/9CU:</i> Bluetooth 2.0 wireless, USB 2.0 via ICH8M, LED indicator Gigabit ethernet, Intel 82566MM Nineveh (PHY), PCIe x1 (GLCI), PXE Intel Active Management Technology (iAMT) High Definition (HD) Audio, AD1984 codec / mono speaker, 0.5 watt / volume up, down, mute buttons / internal microphone, mic input jack (pink), headphone jack (green) Power-on password, hard disk password, supervisor password, security keyhole										
Security Security chip Fingerprint reader	Trusted Platform Module , Atmel chip, TCG 1.2-compliant <i>Some:</i> Fingerprint reader on palm rest , swipe sensor, supports the security chip										
Limited warranty ¹²	3-years/1-yr battery - EasyServ™¹⁹ depot repair service / service upgrades²² available										

Preloaded operating system²⁰
- *Some:* Microsoft® Windows® Vista® Business Edition (32-bit)
- *Some:* Microsoft Windows Vista Ultimate Edition (32-bit)
- *Some:* Microsoft Windows XP Tablet PC Edition 2005
↔ *2GB Vista D6U/H7U/98U/BEU/9CU:* Vista Premium logo
↔ *Other Vista models:* Vista Basic logo

Preloaded applications¹⁴ (all OSes; only some listed)
• Rescue and Recovery™
• Access Connections™
• Client Security Solution™
• ThinkVantage Productivity Center
• ThinkVantage System Update
• Norton Internet Security™
• PC-Doctor™ (diagnostics)
• Fingerprint Software
• Corel VirtualDrive CD/DVD Emulator

Supports ThinkVantage® technologies

ThinkPad X6 Tablet UltraBase

- Provides desktop expansion and cable mgmt for X60/X61 Tablet
- Connects to the bottom of tablet
- Converts tablet to a two-spindle system with optional flat bezel Ultrabay Slim options in right side:
 - ThinkPad Advanced Ultrabay Battery II 3-cell (flat) 43R9250
 - ThinkPad DVD Ultrabay Slim Burner (flat bezel) 41N5643
 - Serial Hard Drive Ultrabay Slim Adapter (flat bezel) 40Y8725
- SATA disks supported (some):
 - 200GB FDE 7200 rpm 41N5738
 - 250GB Disk 5400 rpm 43R8152
 - 320GB Disk 5400 rpm 43N3403

Other features:

- Power button (front)
- Stereo speakers (1 watt)
- Security key lock, security keyhole, and optional security screw
- Serial and parallel ports
- Analog VGA monitor port (no DVI)
- Four USB 2.0 ports
- Gigabit ethernet port (RJ-45)
- Modem port (RJ-11)
- Microphone in and headphone out
- Requires 65- or 90-watt AC adapter
- 1.48 lb; 670g

65-watt (GMA graphics) AC Adapter ENERGY STAR® 4.0-compliant RoHS-compliant International Warranty Service¹⁷ 24 hour x 7 day¹⁸ toll-free support during the warranty period¹² via 800-426-7378

See footnotes for important warranty information
 * Intel Centrino® processor technology
 † US model announced May 20, 2008;
 ‡ Intel Centrino with vPro™ technology
 § previous models on May 31, Oct 30, 2007, Feb 12, 2008
 ¶ US models withdrawn effective December 2007 or May 2008
 © Lenovo (DL2-2) June 2008

ThinkPad® X61 Tablet (7763) - Onsite

Personal Systems Reference (PSREF)

Type-model	Low Voltage proc-processor	GHz	Memory	Display	Disk SATA GB ³ rpm	Optical in UltraBase	X6 Tablet UltraBase	Mini PCIe 802.11 wireless	Mini PCIe WWAN or Turbo	Finger print reader	Bat-tery cells	Vista preload	Workhorse (W) Global (G) GMP (P)	Avail date
7763-54U	L7500	1.60	1GB	12.1" XGA	80GB 5400	Optional	Optional	*Intel 4965AG ³²	None	Fing	8	Business	32 W G P	Jun 07
7763-95U	L7500	1.60	1GB	12.1" SXGA+ SV	80GB 5400	Optional	Optional	*Intel 4965AG	None	Fing	8	Business	32 W G P	Jun 07
7763-B6U	L7500	1.60	1GB	12.1" XGA Touch	120G 5400	Optional	Optional	*Intel 4965AG	None	Fing	8	Business	32 W G P	Jun 07
7763-58U	L7500	1.60	2GB	12.1" XGA	120G 5400	Optional	Optional	*Intel 4965AG	None	Fing	8	Ultimate	32 W G P	Jun 07

• These models are part of the Global Models Plus program with limited onsite service²⁴ 3-year limited warranty

Positioning	Convertible tablet; one spindle												
Processor	Intel® Core™ 2 Duo processor L7500 with low voltage, dual-core, Intel 64 Technology, EIST ¹ , Intel Dynamic Acceleration, Execute Disable Bit, Virtualization Technology, 800MHz system bus, and 4MB shared L2 cache												
Memory	1GB or 2GB std / 4GB max ⁷ / PC2-5300 667MHz DDR2, non-parity, dual-channel capable, two 200-pin SO-DIMM sockets; <i>Non-italics:</i> standard memory in one socket; one socket available												
Ultrabay™ Slim EIDE DVD±RW Serial ATA disk	Supports Ultrabay Slim devices in optional or standard <i>ThinkPad X6 Tablet UltraBase</i> Option for <i>ThinkPad X6 Tablet UltraBase</i> 80GB³ (5400 rpm), 120GB (5400 rpm) / SATA 1.5Gb/s, 9.5mm high, removable, upgradable, supports 2nd disk in std or optional <i>X6 Tablet UltraBase</i> , ThinkPad Shock Mounted Hard Drive, Active Protection System™												
Display	<i>Some:</i> 12.1" (307mm) XGA (1024x768) TFT color, 185 nits, 4:3, 500:1, 170° viewing <i>Some:</i> 12.1" (307mm) SXGA+ (1400x1050) color, 190 nits, 4:3, 500:1, 170° viewing, direct bonding panel (SuperView) for improved outdoor viewability <i>Touch:</i> 12.1" (307mm) XGA (1024x768) TFT color, 4:3, 150 nits, 170° viewing / MultiView (indoor/outdoor), MultiTouch (touchscreen via finger and pen) <i>All:</i> Super Wide Angle FFS / anti-reflective and anti-glare protective coatings / write on screen with standard digitizer pen / pen holder in front base / rotate and swivel hinge in middle bottom of display for tablet mode (portrait or landscape) or picture frame mode (keyboard faces away from user) / buttons on display bottom (power, lock, reboot, rotation, utility, Esc, NavDial/enter)												
Graphics controller	Intel Graphics Media Accelerator X3100 (GMA X3100) , integrated in GM965 Graphics - external External VGA monitor support via analog DB-15 connector / no DVI-out support												
Keyboard	89-key, ThinkVantage button, spill-resistant, multimedia Fn keys, 18.5mm pitch TrackPoint® pointing device, "Press-to-Select," Internet Scroll Bar ¹³ , magnifying glass												
Dimensions ³	<i>without X6 UltraBase:</i> 4-cell: 10.8" x 9.6" x 1.1-1.3"; 274mm x 244mm x 27.4-33.1mm <i>without X6 UltraBase:</i> 8-cell: 10.8" x 10.5" x 1.1-1.3"; 274mm x 267mm x 27.4-33.1mm <i>4-cell:</i> starting at 3.77 lb (1.71kg); <i>8-cell:</i> starting at 4.25 lb (1.93kg)												
Weight ²	Color: black; <i>All:</i> magnesium alloy												
Case material	Li-Ion 8-cell ;												
Battery - type	supports optional Extended Life Battery on base (for two batteries); supports optional Ultrabay Slim battery in optional <i>X6 Tablet UltraBase</i> (for 2 batteries)												
Battery - life ¹⁰	<i>with 4-cell:</i> up to 3.0 hr; <i>with 8-cell:</i> up to 7.0 hr; <i>8-cell and Ultrabay Slim:</i> up to 9.0 hr <i>with 8-cell and optional Extended Life Battery:</i> up to 9.5 hr												
Chipset	Mobile Intel GM965 Express Chipset (Graphics Memory Controller Hub); ICH8M-Enhanced I/O Controller Hub (SATA 3.0Gb/s, ATA-100 EIDE, PCI Express® x1, PCI bus, USB, LPC bus, [Bluetooth], [fingerprint]) / PCI bus (Ricoh® R5C847 Cardbus/1394/Multicard) / LPC bus (PC87385 Super I/O, Atmel® 97SC3203 TPM)												
Media slice	<i>Option:</i> ThinkPad X6 Tablet UltraBase (see right side)												
Secure Digital slot	One Secure Digital Card slot, supports SD memory cards used in consumer devices												
PC Card slot	One Type I or one Type II, CardBus Plus (34mm ExpressCard via adapter), door												
Ports	Three USB 2.0, DB-15 (external VGA monitor), -RJ-11 (modem), RJ-45 (ethernet), IEEE 1394 FireWire 400 (4-pin connector; 1394a-2000 standard)												
Wireless antenna	UltraConnect™ II Antenna / on-off switch for all wireless radios												
Mini PCI Express	Two Mini PCI Express slots / only 802.11 wireless is customer upgradable												
Intel 4965AG ³²	11a/b/g wireless ⁴ , Mini PCIe adapter, Intel Wireless WiFi Link 4965AG												
WWAN	None												
Turbo 1G	None												
Modem	56K V.92 ⁶ modem in Communications Daughter Card												
Bluetooth™	Bluetooth 2.0 wireless, USB 2.0 via ICH8M, LED indicator												
Ethernet	Gigabit ethernet, Intel 82566MM Nineveh (PHY), PCIe x1 (GLCI), PXE												
Intel AMT	Intel Active Management Technology (IAMT)												
Audio support	High Definition (HD) Audio, AD1984 codec / mono speaker 0.5 watt / volume up, down, mute buttons / internal microphone, mic input jack (pink), headphone jack (green)												
Security	Power-on password, hard disk password, supervisor password, security keyhole												
Security chip	Trusted Platform Module , Atmel chip, TCG 1.2-compliant												
Fingerprint reader	Fingerprint reader on palm rest , swipe sensor, supports the security chip												
Limited warranty ¹²	3-years/1-year battery, limited onsite service²⁴ , 8 am - 5 pm, Mon - Fri coverage excluding holidays, next business day response time / service upgrades ²² available												
ThinkPlus™.22	4-year LOR ²⁴ 9x5 NBD		12X5630		Post-warranty annual maintenance agreements at								
ThinkPlus	5-year LOR 9x5 NBD		43R2162		lenovo.com/thinkplus/warranty								
											Preloaded operating system²⁰ - <i>Some:</i> Microsoft® Windows® Vista® Business Edition (32-bit) - <i>Some:</i> Microsoft Windows Vista Ultimate Edition (32-bit) ♦ <i>Vista models:</i> Vista Basic logo		
											Preloaded applications¹⁴ (all OSes; only some listed) • Rescue and Recovery™ • Access Connections™ • Client Security Solution™ • ThinkVantage Productivity Center • ThinkVantage System Update • Norton Internet Security™ (90 days of virus definitions) • Diskeeper® Home • ThinkPad Utilities • PC-Doctor™ (diagnostics) • Fingerprint Software • Corel® VirtualDrive CD/DVD Emulator		
											Supports ThinkVantage® technologies		
											ThinkPad X6 Tablet UltraBase • Provides desktop expansion and cable mgmt for X60/X61 Tablet • Connects to the bottom of tablet • Converts tablet to a two-spindle system with optional flat bezel Ultrabay Slim options in right side: - ThinkPad Advanced Ultrabay Battery II 3-cell (flat) 43R9250 - ThinkPad DVD Ultrabay Slim Burner (flat bezel) 41N5643 - Serial Hard Drive Ultrabay Slim Adapter (flat bezel) 40Y8725 SATA disks supported (some): • 200GB FDE 7200 rpm 41N5738 • 250GB Disk 5400 rpm 43R8152 • 320GB Disk 5400 rpm 43N3403		
											Other features: • Power button (front) • Stereo speakers (1 watt) • Security key lock, security keyhole, and optional security screw • Serial and parallel ports • Analog VGA monitor port (no DVI) • Four USB 2.0 ports • Gigabit ethernet port (RJ-45) • Modem port (RJ-11) • Microphone in and headphone out • Requires 65- or 90-watt AC adapter • 1.48 lb; 670g		
											65-watt (GMA graphics) AC Adapter ENERGY STAR® 4.0-compliant RoHS-compliant International Warranty Service ¹⁷ 24 hour x 7 day ¹⁸ toll-free support during the warranty period ¹² via 800-426-7378		

See footnotes for important warranty information
US models announced May 31, 2007

* Intel Centrino with vPro™ technology

© Lenovo
(DL2-6) February 2008

ThinkPad® X61 Tablet (7767) - TopSeller (3-year)

Personal Systems Reference (PSREF)

Type-model	Low Voltage proc-processor	GHz	Memory	Display	Disk SATA GB ⁸ rpm	Optical in UltraBase	X6 Tablet UltraBase	Mini PCIe 802.11 wireless	Mini PCIe WWAN or Turbo	Finger Bat-tery print ertery readercells	Workhorse (W) Vista Global (G) Avail date
7767-59U	L7500 LV	1.60	1GB	12.1" XGA	120G 5400			*Intel 11a/b/g ³²		Fing 4	Business 32 Jun 07
7767-5AU	L7500 LV	1.60	1GB	12.1" XGA	120G 5400	DVD±RW	UltraBase	*Intel 11n ²⁸	1G Turbo	Fing 4	Business 32 Jun 07
7767-96U	L7500 LV	1.60	2GB	12.1" SXGA+ SV	120G 5400	DVD±RW	UltraBase	*Intel 11a/b/g	1G Turbo	Fing 8	Business 32 Jun 07
7767-B7U	L7500 LV	1.60	2GB	12.1" XGA Touch	120G 5400			*Intel 11n	1G Turbo	Fing 8	Business 32 Jun 07
7767-C3U	L7500 LV	1.60	1GB	12.1" XGA Touch	100G 7200	DVD±RW	UltraBase	*Intel 11a/b/g	Verizon	Fing 8	Ultimate 32 W Jul 07
7767-C4U	L7500 LV	1.60	1GB	12.1" XGA Touch	120G 5400	DVD±RW	UltraBase	*Intel 11n	AT&T	Fing 8	Ultimate 32 W Jul 07
7767-01U	L7500 LV	1.60	1GB	12.1" XGA	120G 5400			*Intel 11a/b/g		Fing 4	XP Tablet Aug 07
7767-02U	L7500 LV	1.60	1GB	12.1" XGA	120G 5400	DVD±RW	UltraBase	*Intel 11a/b/g		Fing 8	XP Tablet Aug 07
7767-5CU	L7500 LV	1.60	2GB	12.1" XGA	160G 7200	DVD±RW	UltraBase	*Intel 11n	1G Turbo	Fing 8	Business 32 Sep 07

• **These small and medium business (SMB) models are part of the US TopSeller™ Program**

Positioning Processor	Convertible tablet; one spindle Intel® Core™ 2 Duo processor L7500 with low voltage, dual-core , Intel 64 Technology, Enhanced Intel SpeedStep® technology ¹ , Intel Dynamic Acceleration, EDB, Virtualization Technology, 800MHz system bus, and 4MB shared L2 cache	Preloaded operating system²⁰ - <i>Some:</i> Microsoft® Windows® Vista® Business Edition (32-bit) - <i>Some:</i> Microsoft Windows Vista Ultimate Edition (32-bit) - <i>Some:</i> Microsoft Windows XP Tablet PC Edition 2005 with Vista COA ◇ <i>Cxx:</i> Vista Basic logo ◇ <i>Other Vista:</i> Vista Premium logo
Memory	1GB or 2GB std / 4GB max ⁷ / PC2-5300 667MHz DDR2, non-parity, dual-channel capable, two 200-pin SO-DIMM sockets; <i>Italics:</i> standard memory in both sockets; no sockets available; <i>Non-italics:</i> standard memory in one socket; one socket available	Preloaded applications¹⁴ (all OSes; only some listed) • Rescue and Recovery™ • Access Connections™ • Client Security Solution™ • ThinkVantage Productivity Center • ThinkVantage System Update • Norton Internet Security (90 days of virus definitions) • PC-Doctor™ (diagnostics) • Fingerprint Software • Microsoft Office 2007 Trial (60-day) • Corel® VirtualDrive CD/DVD Emulator
Ultrabay™ Slim EIDE DVD±RW Serial ATA disk	Supports Ultrabay Slim devices in optional or standard <i>ThinkPad X6 Tablet UltraBase</i> <i>Some:</i> DVD burner, Super Multi-Burner (40Y8623), dual-layer, removable from X6 100GB⁹ (7200 rpm), 120GB (5400 rpm), or 160GB (7200 rpm) / SATA 1.5Gb/s, 9.5mm high, removable, upgradable, supports 2nd disk in std or optional <i>X6 Tablet UltraBase</i> , ThinkPad Shock Mounted Hard Drive, Active Protection System™	
Display	<i>Some:</i> 12.1" (307mm) XGA (1024x768) TFT color, 155 nits, 4:3, 500:1, 170° viewing <i>Some:</i> 12.1" (307mm) SXGA+ (1400x1050) color, 190 nits, 4:3, 500:1, 170° viewing, direct bonding panel (SuperView) for improved outdoor viewability <i>Touch:</i> 12.1" (307mm) XGA (1024x768) TFT color, 4:3, 150 nits, 170° viewing / MultiView (indoor/outdoor), MultiTouch (touchscreen via finger and pen) <i>All:</i> Super Wide Angle FFS / anti-reflective and anti-glare protective coatings / write on screen with standard digitizer pen / pen holder in front base / rotate and swivel hinge in middle bottom of display for tablet mode (portrait or landscape) or picture frame mode (keyboard faces away from user) / buttons on display bottom (power, lock, reboot, rotation, utility, Esc, NavDial/enter)	
Graphics controller Graphics - external	Intel Graphics Media Accelerator X3100 (GMA X3100) , integrated in GM965 External VGA monitor support via analog DB-15 connector / no DVI-out support	
Keyboard TrackPoint®	89-key, ThinkVantage button, spill-resistant, multimedia Fn keys, 18.5mm pitch TrackPoint® pointing device, "Press-to-Select," Internet Scroll Bar ¹³ , magnifying glass	
Dimensions ³	<i>without X6 UltraBase:</i> <i>4-cell:</i> 10.8" x 9.6" x 1.1-1.3"; 274mm x 244mm x 27.4-33.1mm <i>without X6 UltraBase:</i> <i>8-cell:</i> 10.8" x 10.5" x 1.1-1.3"; 274mm x 267mm x 27.4-33.1mm <i>4-cell:</i> starting at 3.77 lb (1.71kg); <i>8-cell:</i> starting at 4.25 lb (1.93kg)	
Weight ² Case material Battery - type	<i>Color:</i> black; <i>All:</i> magnesium alloy Li-Ion 4-cell or 8-cell ; supports optional Extended Life Battery on base (for two batteries); supports optional Ultrabay Slim battery in optional <i>X6 Tablet UltraBase</i> (for 2 batteries) <i>with 4-cell:</i> up to 3.0 hr; <i>with 8-cell:</i> up to 7.0 hr; <i>8-cell and Ultrabay Slim:</i> up to 9.0 hr <i>with 8-cell and optional Extended Life Battery:</i> up to 9.5 hr	Supports ThinkVantage® technologies
Battery - life ¹⁰		ThinkPad X6 Tablet UltraBase • Provides desktop expansion and cable mgmt for X60/X61 Tablet • Connects to the bottom of tablet • Converts tablet to a two-spindle system with optional flat bezel Ultrabay Slim options in right side: – ThinkPad Advanced Ultrabay Battery II 3-cell (flat) 43R9250 – ThinkPad DVD Ultrabay Slim Burner (flat bezel) 41N5643 – Serial Hard Drive Ultrabay Slim Adapter (flat bezel) 40Y8725 SATA disks supported (some): • 200GB FDE 7200 rpm 41N5738 • 320GB Disk 5400 rpm 43N3403
Chipset	Mobile Intel GM965 Express Chipset (Graphics Memory Controller Hub); ICH8M-Enhanced I/O Controller Hub (SATA 3.0Gb/s, ATA-100 EIDE, PCI Express® x1, PCI bus, USB, LPC bus, [Bluetooth], [fingerprint]) / PCI bus (Ricoh® R5C847 Cardbus/1394/Multicard) / LPC bus (PC87385 Super I/O, Atmel® 97SC3203 TPM)	
Media slice Secure Digital slot PC Card Ports	<i>Some:</i> ThinkPad X6 Tablet UltraBase (see right side) One Secure Digital Card slot, supports SD memory cards used in consumer devices One slot (Type I, Type II), CardBus Plus (34mm ExpressCard via adapter), door Three USB 2.0, DB-15 (external VGA monitor), -RJ-11 (modem), RJ-45 (ethernet), IEEE 1394 FireWire 400 (4-pin connector; 1394a-2000 standard)	
Wireless antenna Mini PCI Express Intel 11a/b/g ³² Intel 11n ²⁸ Verizon ¹⁶ AT&T ²³ 1G Turbo Modem Bluetooth™ Ethernet Intel AMT Audio support	UltraConnect™ II Antenna / on-off switch for all wireless radios Two Mini PCI Express slots / only 802.11 wireless is customer upgradable <i>Some:</i> 11a/b/g wireless ⁴ , Mini PCI Express adapter, Intel PRO/Wireless 3945ABG <i>Some:</i> 11a/b/g/n wireless ⁴ , Mini PCIe adapter, Intel Wireless WiFi Link 4965AGN, MIMO 2x3 (Kedron) <i>Some:</i> Wireless WAN, Sierra Wireless 1xEV-DO Network Adapter, Mini PCIe adapter, EV-DO Rev. A, service contract required with Verizon® Wireless <i>Some:</i> Wireless WAN, GPRS/EDGE/UMTS/HSDPA support, Mini PCIe adapter and SIM, service contract required with AT&T® <i>Some:</i> Intel Turbo Memory, Mini PCIe adapter, 1GB flash, disk-cache accelerator 56K V.92 ⁵ modem in Communications Daughter Card Bluetooth 2.0 wireless, USB 2.0 interface via ICH8M, LED indicator Gigabit ethernet, Intel 82566MM Nineveh (PHY), PCIe x1 (GLCI), PXE Intel Active Management Technology (AMT) High Definition (HD) Audio, AD1984 codec / mono speaker, 0.5 watt / volume up, down, mute buttons / internal microphone, mic input jack (pink), headphone jack (green)	Other features: • Power button (front) • Stereo speakers (1 watt) • Security key lock, security keyhole, and optional security screw • Serial and parallel ports • Analog VGA monitor port (no DVI) • Four USB 2.0 ports • Gigabit ethernet port (RJ-45) • Modem port (RJ-11) • Microphone in and headphone out • Requires 65- or 90-watt AC adapter • 1.48 lb; 670g
Security Security chip Fingerprint reader	Power-on password, hard disk password, supervisor password, security keyhole Trusted Platform Module , Atmel chip, TCG 1.2-compliant Fingerprint reader on palm rest , swipe sensor, supports the security chip	65-watt (GMA graphics) AC Adapter ENERGY STAR® 4.0-compliant RoHS-compliant International Warranty Service ¹⁷ 24 hour x 7 day ¹⁸ toll-free support during the warranty period ¹² via 800-426-7378
Limited warranty ¹²	3-years/1-yr battery - EasyServ™ ¹⁹ depot repair service, service upgrades ²² available	

See footnotes for important warranty information
¹² US model announced September 4, 2007;
 previous models on May 31, June 12, or August 14, 2007

* Intel Centrino® processor technology
 * Intel Centrino with vPro™ technology

© Lenovo
 (DL2-3) September 2007

ThinkPad® X61 Tablet (Education) - EasyServ

Personal Systems Reference (PSREF)

Type-model	Low Voltage proc- essor	GHz	Memory	Display	Disk SATA GB ⁸ rpm	Optical in UltraBase	X6 Tablet UltraBase	Mini PCIe 802.11 wireless	Mini PCIe WWAN or Turbo	Vista preload	Educ pre- load	Limited warranty ¹²	Workhorse (W) Global (G) Avail date
7762-B5U	L7500 LV	1.60	1GB	12.1" XGA <i>Touch</i>	120G 5400	Optional	Optional	11a/b/g ³²	None	Business 32	HE	EasyServ	W Jun 07
7762-01U	L7500 LV	1.60	1GB	12.1" XGA	100G 7200	Optional	Optional	11a/b/g	None	Business 32	HE	EasyServ	July 07
7762-02U	L7500 LV	1.60	1GB	12.1" XGA <i>Touch</i>	100G 7200	Optional	Optional	11a/b/g	None	Business 32	K12	EasyServ	July 07
<p>• These models have an EasyServ™¹⁹ depot repair service 3-year limited warranty Educational models are available only to public or private K-12 or higher accredited schools organized and operated exclusively for educational purposes for use by qualified students and teachers.</p>													
Positioning Processor	Convertible tablet; one spindle Intel® Core™ 2 Duo processor L7500 with low voltage, dual-core, Intel 64 Technology, Enhanced Intel SpeedStep® technology¹, Intel Dynamic Acceleration, Execute Disable Bit, Virtualization Technology, 800MHz system bus, and 4MB shared L2 cache										Preloaded operating system²⁰ - Microsoft® Windows® Vista® Business Edition (32-bit) ⇨ Vista Basic logo		
Memory	1GB or 2GB std / 4GB max⁷ / PC2-5300 667MHz DDR2, non-parity, dual-channel capable, two 200-pin SO-DIMM sockets; Non-italics: standard memory in one socket; one socket available										Preloaded applications¹⁴ (only some listed) <ul style="list-style-type: none"> • <i>01U/02U</i>: Microsoft Office OneNote® 2007 (and CD) • <i>Some (K12)</i>: K-12 education software <ul style="list-style-type: none"> - VitalSource Library School Edition - Adobe® Instructor Resource Center - Adobe Digital School Collection <ul style="list-style-type: none"> - Photoshop Elements 5 (and CD) - Premier Elements 3 (and DVD) - Acrobat 8 Professional (and CD) - Contribute 4 (and CD) • <i>(HE)</i>: Higher education software <ul style="list-style-type: none"> - VitalSource Library College Edition - Adobe Instructor Resource Center - Adobe Photoshop Elements 5 (and CD) - Adobe Premier Elements 3 (and DVD) • Rescue and Recovery™ • Access Connections™ • Client Security Solution™ • Norton Internet Security • Corel® VirtualDrive CD/DVD Emulator 		
Ultrabay™ Slim EIDE DVD±RW Serial ATA disk	Supports Ultrabay Slim devices in optional or standard <i>ThinkPad X6 Tablet UltraBase</i> 120GB⁸ (5400 rpm) or 100GB (7200 rpm) / SATA 1.5Gb/s, 9.5mm high, removable, upgradable, supports 2nd disk in std or optional X6 Tablet UltraBase, ThinkPad Shock Mounted Hard Drive, Active Protection System™												
Display	<i>Some:</i> 12.1" (307mm) XGA (1024x768) TFT color, 185 nits, 4:3, 500:1, 170° viewing <i>Touch:</i> 12.1" (307mm) XGA (1024x768) TFT color, 4:3, 150 nits, 170° viewing / MultiView (indoor/outdoor), MultiTouch (touchscreen via finger and pen) Super Wide Angle FFS / anti-reflective and anti-glare protective coatings / write on screen with standard digitizer pen / pen holder in front base / rotate and swivel hinge in middle bottom of display for tablet mode (portrait or landscape) or picture frame mode (keyboard faces away from user) / buttons on display bottom (power, lock, reboot, rotation, utility, Esc, NavDial/enter) <i>All:</i>												
Graphics controller Graphics - external	Intel Graphics Media Accelerator X3100 (GMA X3100) , integrated in GM965 External VGA monitor support via analog DB-15 connector / no DVI-out support												
Keyboard TrackPoint®	89-key, ThinkVantage button, spill-resistant, multimedia Fn keys, 18.5mm pitch TrackPoint® pointing device, "Press-to-Select," Internet Scroll Bar ¹³ , magnifying glass												
Dimensions ³	<i>without X6 UltraBase: 4-cell:</i> 10.8" x 9.6" x 1.1-1.3"; 274mm x 244mm x 27.4-33.1mm <i>without X6 UltraBase: 8-cell:</i> 10.8" x 10.5" x 1.1-1.3"; 274mm x 267mm x 27.4-33.1mm <i>4-cell:</i> starting at 3.77 lb (1.71kg); <i>8-cell:</i> starting at 4.25 lb (1.93kg)												
Weight ² Case material Battery - type	<i>Color:</i> black; <i>All:</i> magnesium alloy Li-Ion 8-cell ; supports optional Extended Life Battery on base (for two batteries); supports optional Ultrabay Slim battery in optional <i>X6 Tablet UltraBase</i> (for 2 batteries)												
Battery - life ¹⁰	<i>with 4-cell:</i> up to 3.0 hr; <i>with 8-cell:</i> up to 7.0 hr; <i>8-cell and Ultrabay Slim:</i> up to 9.0 hr <i>with 8-cell and optional Extended Life Battery:</i> up to 9.5 hr										Supports ThinkVantage® technologies		
Chipset	Mobile Intel GM965 Express Chipset (Graphics Memory Controller Hub); ICH8M-Enhanced I/O Controller Hub (SATA 3.0Gb/s, ATA-100 EIDE, PCI Express® x1, PCI bus, USB, LPC bus, [Bluetooth], [fingerprint]) / PCI bus (Ricoh® R5C847 Cardbus/1394/Multicard) / LPC bus (PC87385 Super I/O, Atmel® 97SC3203 TPM)										ThinkPad X6 Tablet UltraBase <ul style="list-style-type: none"> • Provides desktop expansion and cable mgmt for X60/X61 Tablet • Connects to the bottom of tablet • Converts tablet to a two-spindle system with optional flat bezel Ultrabay Slim options in right side: <ul style="list-style-type: none"> - ThinkPad Advanced Ultrabay Battery II 3-cell (flat) 43R9250 - ThinkPad DVD Ultrabay Slim Burner (flat bezel) 41N5643 - Serial Hard Drive Ultrabay Slim Adapter (flat bezel) 40Y8725 • SATA disks supported (some): <ul style="list-style-type: none"> • 200GB FDE 7200 rpm 41N5738 		
Media slice Secure Digital slot PC Card Ports	<i>Option:</i> ThinkPad X6 Tablet UltraBase (see right side) One Secure Digital Card slot , supports SD memory cards used in consumer devices One slot (Type I, Type II), CardBus Plus (34mm ExpressCard via adapter), door Three USB 2.0, DB-15 (external VGA monitor), -RJ-11 (modem), RJ-45 (ethernet), IEEE 1394 FireWire 400 (4-pin connector; 1394a-2000 standard)												
Wireless antenna Mini PCI Express 11a/b/g ³² WWAN Turbo 1G Modem Bluetooth™ Ethernet Intel AMT Audio support	UltraConnect™ II Antenna / on-off switch for all wireless radios Two Mini PCI Express slots / only 802.11 wireless is customer upgradable 11a/b/g wireless ⁴ , ThinkPad 11a/b/g Mini PCIe Adapter, Atheros AR5006EX None None 56K V.92 ⁶ modem in Communications Daughter Card Bluetooth 2.0 wireless, USB 2.0 interface via ICH8M, LED indicator Gigabit ethernet, Intel 82566MM Nineveh (PHY), PCIe x1 (GLCI), PXE Intel Active Management Technology (iAMT) High Definition (HD) Audio, AD1984 codec / mono speaker, 0.5 watt / volume up, down, mute buttons / internal microphone, mic input jack (pink), headphone jack (green)												
Security Security chip Fingerprint reader	Power-on password, hard disk password, supervisor password, security keyhole Trusted Platform Module , Atmel chip, TCG 1.2-compliant Fingerprint reader on palm rest , swipe sensor, supports the security chip												
Limited warranty ¹²	3-years/1-yr battery - EasyServ™¹⁹ depot repair service / service upgrades²² available												
512 MB PC2-5300 DDR2 SODIMM	40Y7733	ThinkPad X6 Tablet UltraBase		41U3120									
1GB PC2-5300 DDR2 SODIMM	40Y7734	ThinkPad X60 Tablet Digitizer Pen		41U3143									
2GB PC2-5300 DDR2 SODIMM	40Y7735	ThinkPad X60 Tether (3-pack)		41U4820									
USB 2.0 Lenovo Webcam	40Y8519	X60 Tablet Li-Ion Battery 8-cell		40Y8318									
USB 2.0 Ultra Secure Memory Key 8GB	45J5918	ThinkPad X60 Extended Life Battery		40Y7005									
USB 2.0 Portable Secure 320GB Hard Disk	43R2019	ThinkPad X60 Tablet Sleeve		41U3142									
USB 2.0 Super Multi-Burner Drive	41N5565	ThinkPad Ultraportable Case		41U5062									
128GB SSD SATA 3.0Gb/s 1.8" (2.5" cover)	43N3406	ThinkPlus™ ²² 2-year LOR 9x5 NBD		41C9175									
Other accessories on O-X60-T sheet	Other accessories at lenovo.com/accessories												
										Other features: <ul style="list-style-type: none"> • Power button (front) • Stereo speakers (1 watt) • Security key lock, security keyhole, and optional security screw • Serial and parallel ports • Analog VGA monitor port (no DVI) • Four USB 2.0 ports • Gigabit ethernet port (RJ-45) • Modem port (RJ-11) • Microphone in and headphone out • Requires 65- or 90-watt AC adapter • 1.48 lb; 670g 			
										65-watt (GMA graphics) AC Adapter ENERGY STAR® 4.0-compliant RoHS-compliant International Warranty Service ¹⁷ 24 hour x 7 day ¹⁸ toll-free support during the warranty period ¹² via 800-426-7378			

See footnotes for important warranty information

US models announced July 16, 2007; previous model on May 31, 2007

© Lenovo (DL2-4) July 2007

ThinkPad® X61 Tablet (Education) - Onsite

Personal Systems Reference (PSREF)

Type-model	Low Voltage proc-essor	GHz	Memory	Display	Disk SATA GB ⁶	rpm	Optical in UltraBase	X6 Tablet UltraBase	Mini PCIe 802.11 wireless	Mini PCIe WWAN or Turbo	Vista preload	Educ pre-load	Warranty ¹²	Workhorse (W) Global (G) Avail date
7763-B5U	L7500 LV	1.60	1GB	12.1" XGA	120G	5400	Optional	Optional	11a/b/g ³²	None	Business 32	HE	Onsite	W Jun 07
7763-01U	L7500 LV	1.60	1GB	12.1" XGA	100G	7200	Optional	Optional	11a/b/g	None	Business 32	HE	Onsite	July 07
7763-02U	L7500 LV	1.60	1GB	12.1" XGA	100G	7200	Optional	Optional	11a/b/g	None	Business 32	K12	Onsite	July 07

• **These models have a limited onsite service²⁴ 3-year limited warranty**
 These educational models are available only to public or private K-12 or higher accredited schools organized and operated exclusively for educational purposes for use by qualified students and teachers.

Positioning Processor	Convertible tablet; one spindle Intel® Core™ 2 Duo processor L7500 with low voltage, dual-core , Intel 64 Technology, Enhanced Intel SpeedStep® technology ¹ , Intel Dynamic Acceleration, Execute Disable Bit, Virtualization Technology, 800MHz system bus, and 4MB shared L2 cache	Preloaded operating system²⁰ - Microsoft® Windows® Vista® Business Edition (32-bit) ↕ Vista Basic logo Preloaded applications¹⁴ (only some listed) • <i>01U/02U</i> : Microsoft Office OneNote® 2007 (and CD) • <i>Some (K12)</i> : K-12 education software - VitalSource Library School Edition - Adobe® Instructor Resource Center - Adobe Digital School Collection - Photoshop Elements 5 (and CD) - Premier Elements 3 (and DVD) - Acrobat 8 Professional - Contribute 4 • <i>(HE)</i> : Higher education software - VitalSource Library College Edition - Adobe Instructor Resource Center - Adobe Photoshop Elements 5 (and CD) - Adobe Premier Elements 3 (and DVD) • Rescue and Recovery™ • Access Connections™ • Client Security Solution™ • Norton Internet Security™ • Corel® VirtualDrive CD/DVD Emulator	
Memory	1GB or 2GB std / 4GB max ⁷ / PC2-5300 667MHz DDR2, non-parity, dual-channel capable, two 200-pin SO-DIMM sockets; <i>Non-italics</i> : standard memory in one socket; one socket available		
Ultrabay™ Slim EIDE DVD±RW Serial ATA disk	Supports Ultrabay Slim devices in optional or standard <i>ThinkPad X6 Tablet UltraBase</i> Option for <i>ThinkPad X6 Tablet UltraBase</i> 120GB⁸ (5400 rpm) / SATA 1.5Gb/s, 9.5mm high, removable, upgradable, supports 2nd disk in std or optional <i>X6 Tablet UltraBase</i> , ThinkPad Shock Mounted Hard Drive, Active Protection System™		
Display	<i>Some</i> : 12.1" (307mm) XGA (1024x768) TFT color, 185 nits, 4:3, 500:1, 170° viewing <i>Touch</i> : 12.1" (307mm) XGA (1024x768) TFT color, 4:3, 150 nits, 170° viewing / MultiView (indoor/outdoor), MultiTouch (touchscreen via finger and pen) <i>All</i> : Super Wide Angle FFS / anti-reflective and anti-glare protective coatings / write on screen with standard digitizer pen / pen holder in front base / rotate and swivel hinge in middle bottom of display for tablet mode (portrait or landscape) or picture frame mode (keyboard faces away from user) / buttons on display bottom (power, lock, reboot, rotation, utility, Esc, NavDial/enter)		
Graphics controller	Intel Graphics Media Accelerator X3100 (GMA X3100) , integrated in GM965		
Graphics - external	External VGA monitor support via analog DB-15 connector / no DVI-out support		
Keyboard TrackPoint®	89-key, ThinkVantage button, spill-resistant, multimedia Fn keys, 18.5mm pitch TrackPoint® pointing device, "Press-to-Select," Internet Scroll Bar ¹³ , magnifying glass		
Dimensions ³	<i>without X6 UltraBase</i> : 4-cell: 10.8" x 9.6" x 1.1-1.3"; 274mm x 244mm x 27.4-33.1mm <i>without X6 UltraBase</i> : 8-cell: 10.8" x 10.5" x 1.1-1.3"; 274mm x 267mm x 27.4-33.1mm 4-cell: starting at 3.77 lb (1.71kg); 8-cell: starting at 4.25 lb (1.93kg) <i>Color</i> : black; <i>All</i> : magnesium alloy		
Weight ² Case material Battery - type	Li-Ion 8-cell ; supports optional Extended Life Battery on base (for two batteries); supports optional Ultrabay Slim battery in optional <i>X6 Tablet UltraBase</i> (for 2 batteries)		
Battery - life ¹⁰	<i>with 4-cell</i> : up to 3.0 hr; <i>with 8-cell</i> : up to 7.0 hr; <i>8-cell and Ultrabay Slim</i> : up to 9.0 hr <i>with 8-cell and optional Extended Life Battery</i> : up to 9.5 hr		
Chipset	Mobile Intel GM965 Express Chipset (Graphics Memory Controller Hub); ICH8M-Enhanced I/O Controller Hub (SATA 3.0Gb/s, ATA-100 EIDE, PCI Express® x1, PCI bus, USB, LPC bus, [Bluetooth], [fingerprint]) / PCI bus (Ricoh® R5C847 Cardbus/1394/Multicard) / LPC bus (PC87385 Super I/O, Atmel® 97SC3203 TPM)		
Media slice	<i>Option</i> : ThinkPad X6 Tablet UltraBase (see right side)		
Secure Digital slot PC Card slot	One Secure Digital Card slot, supports SD memory cards used in consumer devices		
Ports	One Type I or one Type II, CardBus Plus (34mm ExpressCard via adapter), door Three USB 2.0, DB-15 (external VGA monitor), -RJ-11 (modem), RJ-45 (ethernet), IEEE 1394 FireWire 400 (4-pin connector; 1394a-2000 standard)		
Wireless antenna	UltraConnect™ II Antenna / on-off switch for all wireless radios		
Mini PCI Express	Two Mini PCI Express slots / only 802.11 wireless is customer upgradable		
11a/b/g ³² WWAN Turbo 1G	11a/b/g wireless ⁴ , ThinkPad 11a/b/g Mini PCIe Adapter, Atheros AR5006EX None None		
Modem	56K V.92 ⁶ modem in Communications Daughter Card		
Bluetooth™	Bluetooth 2.0 wireless, USB 2.0 interface via ICH8M, LED indicator		
Ethernet	Gigabit ethernet, Intel 82566MM Nineveh (PHY), PCIe x1 (GLCI), PXE		
Intel AMT	Intel Active Management Technology (iAMT)		
Audio support	High Definition (HD) Audio, AD1984 codec / mono speaker, 0.5 watt / volume up, down, mute buttons / internal microphone, mic input jack (pink), headphone jack (green)		
Security	Power-on password, hard disk password, supervisor password, security keyhole		
Security chip	Trusted Platform Module , Atmel chip, TCG 1.2-compliant		
Fingerprint reader	Fingerprint reader on palm rest , swipe sensor, supports the security chip		
Limited warranty ¹²	3-years/1-year battery, limited onsite service²⁴ , 8 am - 5 pm, Mon - Fri coverage excluding holidays, next business day response time ²⁴		
1GB PC2-5300 DDR2 SODIMM	40Y7734	ThinkPad X6 Tablet UltraBase	41U3120
2GB PC2-5300 DDR2 SODIMM	40Y7735	ThinkPad X60 Tablet Digitizer Pen	41U3143
USB 2.0 Lenovo Multimedia Headset	40Y8518	ThinkPad X60 Tether (3-pack)	41U4820
USB 2.0 Security Memory Key 4GB	41U5120	X60 Tablet Li-ion Battery 8-cell	40Y8318
USB 2.0 Super Multi-Burner Drive	41N5565	ThinkPad X60 Extended Life Battery	40Y7005
320GB Disk SATA 1.5Gb/s (5400 rpm)	43N3403	ThinkPad X60 Tablet Sleeve	41U3142
TrackPoint Cap Collection	73P2698	ThinkPad Ultraportable Case	41U5062
Other accessories on O-X60-T sheet		Other accessories at lenovo.com/accessories	

65-watt (GMA graphics) AC Adapter ENERGY STAR® 4.0-compliant RoHS-compliant International Warranty Service¹⁷ 24 hour x 7 day¹⁸ toll-free support during the warranty period¹² via 800-426-7378

See footnotes for important warranty information

US models announced July 16, 2007; previous model on May 31, 2007

© Lenovo (DL2-5) July 2007

Partial list of accessories supported on:

- ThinkPad X60 Tablet originally announced on Nov 14, 2006
- ThinkPad X61 Tablet originally announced on May 31, 2007

Memory		
512MB PC2-5300 DDR2 SODIMM	40Y7733	ann 01/05/06
1GB PC2-5300 DDR2 SODIMM (TopSeller)	43R1999	ann 03/25/08
1GB PC2-5300 DDR2 SODIMM	40Y7734	ann 01/05/06
2GB PC2-5300 DDR2 SODIMM (TopSeller)	43R2000	ann 03/25/08
2GB PC2-5300 DDR2 SODIMM	40Y7735	ann 11/28/06

Ultrabay Slim 9.5mm		
None (Ultrabay Slim on optional <i>ThinkPad X6 Tablet UltraBase</i>)		

Ultrabay Enhanced 12.7mm		
None		

Storage and removable storage		
160GB Disk SATA 1.5Gb/s (5400 rpm) ⁴¹	41N5692	ann 03/20/07
160GB Disk SATA 1.5Gb/s (7200 rpm) ⁴¹	41N5737	ann 10/16/07
250GB Disk SATA 1.5Gb/s (5400 rpm) ⁴¹	43R8152	ann 01/15/08
320GB Disk SATA 1.5Gb/s (5400 rpm) ⁴¹	43N3403	ann 08/05/08
⁴¹ Can be used as the main disk or with <i>ThinkPad Serial ATA Hard Drive Ultrabay Slim Adapter 40Y8725</i> in the optional <i>ThinkPad X6 Tablet Ultrabase 41U3120</i> .		

128GB SSD SATA 3.0Gb/s 1.8" (2.5" cover)	43N3406	ann 08/26/08
USB 2.0 Essential Memory Key 4GB	45J7904	ann 06/24/08
USB 2.0 Essential Memory Key 8GB	45J7905	ann 07/15/08
USB 2.0 Essential Memory Key 32GB	45K1258	ann 10/28/08
USB 2.0 Security Memory Key 2GB	41U5119	ann 07/17/07
USB 2.0 Security Memory Key 4GB	41U5120	ann 07/17/07
USB 2.0 Ultra Secure Memory Key 2GB	45J5916	ann 08/26/08
USB 2.0 Ultra Secure Memory Key 4GB	45J5917	ann 08/26/08
USB 2.0 Ultra Secure Memory Key 8GB	45J5918	ann 08/26/08
USB Portable Diskette Drive	05K9276	ann 06/05/00
USB 2.0 CD-RW/DVD-ROM Combo II Drive	40Y8637	ann 01/05/06
USB 2.0 Portable 160GB Hard Disk	43R1784	ann 09/23/08
USB 2.0 Portable Secure 160GB Hard Disk	43R2018	ann 11/18/08
USB 2.0 Portable Secure 320GB Hard Disk	43R2019	ann 11/18/08
USB 2.0 Super Multi-Burner Drive	41N5565	ann 01/23/07

Wireless WAN (Mini PCI Express)		
<i>Only 7762-54U and 7762-63U models:</i>		
Verizon WWAN EV-DO Rev. A Mini PCIe	43R1818	ann 03/04/08

ThinkPad Expansion		
USB 2.0 Lenovo Enhanced Port Replicator	43R8770	ann 02/26/08
ThinkPad Adjustable Notebook Stand	40Y7676	ann 09/20/05
ThinkPad X6 Tablet UltraBase	41U3120	ann 11/14/06

Keyboard		
TrackPoint Cap Collection	73P2698	ann 12/16/03
USB Numeric Keypad	33L3225	ann 05/01/00
Preferred Pro USB Keyboard	73P5220	ann 06/21/05
Enhanced Performance USB Keyboard	73P2620	ann 03/23/04
Wireless Kybd & Opt Wheel Mouse (via USB)	73P4067	ann 12/07/04
USB Keyboard with UltraNav	31P8950	ann 01/28/03
USB Travel Keyboard with UltraNav	31P9490	ann 04/27/04
Lenovo USB Fingerprint Keyboard	73P4730	ann 02/22/05

Mouse		
Optical Wheel Mouse (USB)	06P4069	ann 05/21/03
Optical ScrollPoint® Mouse (USB, PS/2)	31P7405	ann 08/27/02
Optical Wheel Travel Mouse (USB, PS/2)	31P7410	ann 06/04/02
Laser Tilt Wheel Mouse (USB, PS/2)	41U3074	ann 01/23/07
Lenovo Wireless Laser Mouse (blk, via USB)	45K1696	ann 11/25/08
Lenovo Wireless Laser Mouse (red, via USB)	51J0198	ann 11/25/08
Laser Tilt Wheel Travel Mouse (Bluetooth)	41U5008	ann 01/22/08
Wireless Kybd & Opt Wheel Mouse (via USB)	73P4067	ann 12/07/04

Security		
Kensington® Cable Lock from Lenovo	73P2582	ann 12/29/03
Kensington Twin Head Cable Lock	45K1620	ann 09/30/08
USB Gemplus GemPC Smart Card Reader	41N3040	ann 02/21/06
PC Card Gemplus Smart Card Reader	41N3004	ann 12/13/05

Multimedia		
USB 2.0 Lenovo Multimedia Headset	40Y8518	ann 06/27/06
USB 2.0 Lenovo Webcam	40Y8519	ann 08/29/06

Batteries		
X60 Tablet Li-Ion 4-cell	40Y8314	ann 11/14/06
X60 Tablet Li-Ion 8-cell	40Y8318	ann 11/14/06
X60 Extended Life Battery	40Y7005	ann 01/05/06
ThinkPad External Battery Charger ⁴⁴	40Y7625	ann 09/20/05
⁴⁴ Requires the <i>ThinkPad 90W AC Adapter 40Y7659</i> (adapter provided with some systems).		
ThinkPad 65W AC Adapter	40Y7696	ann 09/20/05
ThinkPad 90W AC Adapter	40Y7659	ann 09/20/05
ThinkPad 90W Slim AC/DC Combo Adapter	41N8460	ann 11/27/07

Tablet		
ThinkPad X60 Tablet Digitizer Pen	41U3143	ann 11/14/06
ThinkPad X60 Tether (3-pack)	41U4820	ann 11/14/06

Carrying Cases		
ThinkPad X60 Tablet Sleeve	41U3142	ann 11/14/06

<i>Up to 13.3" widescreen models:</i>		
ThinkPad Ultraportable Case	41U5062	ann 05/13/08

<i>Up to 14.1" widescreen models:</i>		
ThinkPad Expander Case	43R9118	ann 06/24/08
ThinkPad Women's Microfiber Tote	22P8855	
ThinkPad Convertible Carrying Case	22P8860	
ThinkPad Women's Executive Leather Tote	22P8857	
Women's Executive Red Leather Tote	22P8858	

<i>Up to 15.4" widescreen models:</i>		
Lenovo Carrying Case - Messenger Max	41U5253	ann 05/01/07
Lenovo Carr Case - Performance Backpack	41U5254	ann 05/01/07
Lenovo Standard Case	45K1697	ann 11/25/08
Lenovo Standard Backpack	45K1698	ann 11/25/08
ThinkPad Business Topload Case	43R2476	ann 05/13/08
ThinkPad Business Backpack	43R2482	ann 05/13/08
ThinkPad Deluxe Expander Case	43R2478	ann 05/13/08
ThinkPad Executive Leather Case	43R2480	ann 05/13/08

<i>Up to 17.0" widescreen models:</i>		
ThinkPad 17W Business Topload Case	43R9117	ann 08/12/08

Monitors		
ThinkVision® L174 17" Monitor	9227AE1	ann 04/15/08
ThinkVision L1700p 17" Monitor	9417HE2	ann 09/17/08
ThinkVision L1900p 19" Monitor	4431HE1	ann 11/11/08
ThinkVision L1940p Wide 19" Monitor	4424HB6	ann 09/17/08
ThinkVision L200p Wide 20.1" Monitor	4438HB6	ann 04/15/08
ThinkVision L2240p Wide 22" Monitor	4422HB6	ann 09/17/08
ThinkVision L2440p Wide 24" Monitor	4420HB2	ann 09/17/08
ThinkVision L2440x Wide 24" Monitor	4421HB2	ann 09/17/08

Monitor Accessories⁴⁶		
ThinkVision USB Soundbar	40Y7616	ann 08/23/05
ThinkVision Soundbar	45K1263	ann 09/16/08
Kensington Cable Lock from Lenovo	73P2582	ann 12/29/03
Kensington Twin Head Cable Lock	45K1620	ann 09/30/08
ThinkPad Convertible Monitor Stand	40Y7620	ann 01/05/06
Radial Arm	19K4464	ann 05/05/00

⁴⁶ Compatible on selected Lenovo and ThinkVision monitors.

More information at www.lenovo.com/support/monitoraccessories

Medialess License Key (MLK)		
Microsoft® Office 2007 Basic, English	43R1528	ann 01/31/07
Microsoft Office 2007 Small Business, Engl	43R1534	ann 01/31/07
Microsoft Office 2007 Professional, English	43R1531	ann 01/31/07

Other accessories at www.lenovo.com/accessories

Accessories Guide pdf at www.lenovo.com/accessoriesguide

ThinkPad®



Lenovo ThinkPad X200



Lenovo ThinkPad X200
with 9-cell Battery



Lenovo ThinkPad X200



Lenovo ThinkPad X200
with optional X200 UltraBase,
DVD Burner, and 9-cell Battery



Lenovo ThinkPad X200



Lenovo ThinkPad X200
with optional X200 UltraBase,
DVD Burner, and 9-cell Battery

ThinkPad® X200 (7454) - TopSeller

Proc- Type-model	essor GHz	Memory	Wide- screen display	Cam- era	Disk SATA GB ⁸ rpm	Optical in UltraBase	ThinkPad X200 UltraBase	Mini PCIe 802.11 wireless	Mini PCIe WWAN	Mini PCIe UWB or Turbo	Finger print reader	Bat- tery cells	Intel AMT	Pre- load	Avail date
7454-2GU	P8600	2.40	2GB	12.1" WXGA	160GB 5400			Intel 5100 ²⁸			Fing 4	XP Pro			Aug 08
7454-2HU	P8600	2.40	2GB	12.1" WXGA	160GB 5400	DVD±RW	UltraBase	Intel 5100			Fing 6	XP Pro			Aug 08
7454-2JU	P8600	2.40	2GB	12.1" WXGA	160GB 7200	DVD±RW	UltraBase	Intel 5300 ²⁸	WWAN upg	2G Turbo	Fing 6	Bus 32			Aug 08
7454-2NU	P8400	2.26	2GB	12.1" WXGA	160GB 5400			Intel 5100	AT&T ²³		Fing 4	Bus 32			Aug 08
7454-2PU	P8400	2.26	2GB	12.1" WXGA	160GB 7200	DVD±RW	UltraBase	Intel 5100	AT&T		Fing 6	Bus 32			Aug 08
7454-2QU	P8600	2.40	2GB	12.1" WXGA	160GB 7200	DVD±RW	UltraBase	Intel 5100	AT&T	2G Turbo	Fing 6	Bus 32			Aug 08
7454-2ZU	P8600	2.40	2GB	12.1" WXGA	160GB 7200	DVD±RW	UltraBase	Intel 5100	AT&T		Fing 6	XP Pro			Sep 08
7454-95U	P8600	2.40	2GB	12.1" WXGA	160GB 5400			Intel 5100			Fing 4	XP Pro			Sep 08
7454-96U	P8600	2.40	2GB	12.1" WXGA	160GB 7200	DVD±RW	UltraBase	Intel 5300	WWAN upg		Fing 6	XP Pro			Sep 08
7454-9FU	P8600	2.40	2GB	12.1" WXGA	160GB 5400			WiMAX	WWAN upg		Fing 4	AMT	Bus 32		Jan 09
7454-9GU	P8600	2.40	3GB	12.1" WXGA	128GB SSD	DVD±RW	UltraBase	Intel 5100	WWAN upg		Fing 6	AMT	XP Pro		Jan 09
<p>• These small and medium business (SMB) models are part of the US TopSeller™ Program</p>															
Positioning	An ultraportable for the executive on the move; one spindle										Preloaded operating system ²⁰				
Processor	Intel® Core™ 2 Duo processor P8400 or P8600 with dual-core, Intel HD boost, 1066MHz system bus, and 3MB L2 cache										- Some: Microsoft® Windows® XP Professional with Vista® COA				
Memory	2GB or 3GB std / 4GB max ⁷ / PC3-8500 1066MHz DDR3, non-parity, dual-channel capable, two 204-pin SO-DIMM sockets; <i>Italics:</i> standard memory in both sockets; no sockets available; <i>Non-italics:</i> standard memory in 1 socket; 1 socket available										- Some: Microsoft Windows Vista Business Edition (32-bit) ◊ Vista Premium logo				
Diskette drive	None (use optional USB-based diskette drive)										Preloaded applications ¹⁴ (all OSes; only some listed)				
SATA DVD±RW	Some: DVD burner (43N3214), SATA 1.5Gb/s, removable from X200 UltraBase										• Rescue and Recovery™				
Ultrabay Slim	Supports Ultrabay Slim devices in optional or standard X200 UltraBase (43R8781)										• Access Connections™				
SATA disk	Some: 128GB ⁸ Solid State Drive (SSD) / SATA 3.0Gb/s, 1.8" wide, 8mm high Some: 160GB ⁸ (5400 or 7200 rpm) / SATA 1.5Gb/s, 2.5" wide, 9.5mm high, Active Protection System™ All: removable, upgradable, Shock Mounted Hard Drive, supports second disk in optional or std X200 UltraBase										• Client Security Solution™				
Widescreen display	12.1" (308mm) WXGA (1280x800) TFT color, anti-glare, CCFL backlight, 200 nits, 16:10 aspect ratio, 250:1 contrast ratio										• ThinkVantage System Update				
Camera	Some: camera on top of screen, 1.3-megapixel, fixed focus										• McAfee VirusScan® Plus with SiteAdvisor™ (30 days of virus definitions)				
Graphics controller	Intel Graphics Media Accelerator 4500MHD (GMA 4500MHD), in GM45										• PC-Doctor™ (diagnostics)				
Graphics - external	External monitor support via analog VGA DB-15 connector / DisplayPort via UltraBase; Maximum external resolution: 2048x1536@75Hz										• FingerPrint Software				
Keyboard	Full-size, 89-key, ThinkVantage button, spill-resistant, mm Fn keys										• Microsoft Office 2007 Trial (60-day)				
TrackPoint®	TrackPoint® pointing device, "Press-to-Select," Internet Scroll Bar ¹³ , magnifying glass										• Roxio® Creator® Business Edition				
Touch pad	None										• Roxio MyDVD® (DVD±RW)				
ThinkLight™	Illuminates the keyboard to improve visibility in low-light conditions										Supports ThinkVantage® technologies				
Dimensions ³	without X200 UltraBase; 4-cell: 11.6" x 8.3" x 0.8-1.4"; 295mm x 210mm x 21-35mm without X200 UltraBase; 9-cell: 11.6" x 9.2" x 0.8-1.4"; 295mm x 234mm x 21-35mm 4-cell: from 2.98 lb (1.35kg); 6-cell: from 3.26 lb (1.48kg); 9-cell: from 3.61 lb (1.64kg)										<p>ThinkPad X200 UltraBase™</p> <ul style="list-style-type: none"> Provides desktop expansion and cable management for X200 Series Easily connects to the bottom of the X200 Series for traveling Converts ThinkPad to a two-spindle system with optional Ultrabay Slim accessories in right side: <ul style="list-style-type: none"> CD-RW/DVD-ROM Ultrabay Slim SATA 1.5Gb/s 43N3213 DVD Burner Ultrabay Slim SATA 1.5Gb/s 43N3214 Blu-ray™ Burner Ultrabay Slim SATA 1.5Gb/s 43N3215 Serial Hard Drive Ultrabay Slim Adapter II 43R1980 Disks supported (some): <ul style="list-style-type: none"> 200GB FDE 7200 rpm 41N5738 320GB Disk 5400 rpm 43R3403 				
Weight ²											Other features:				
Case color	Black										• Power button (front)				
Case material	Magnesium alloy										• Stereo speakers (2 watt)				
Battery - type	Lithium Ion 4-cell or 6-cell										• Security key lock, security keyhole, and optional security screw				
Battery - life ¹⁰	4-cell: up to 3.3 hr; 6-cell: up to 6.5 hr; 9-cell: up to 9.8 hr										• Analog DB-15 monitor port				
Chipset	Mobile Intel GM45 Express Chipset (Graphics Memory Controller Hub), ICH9M-Enhanced I/O Controller Hub (SATA 3.0Gb/s, USB 2.0, PCI Express® 1.1, PCI 2.3, security chip, ethernet MAC)										• DisplayPort (supports single-link DVI-D via cable 45J7915)				
Media slice	Some: X200 UltraBase media slice (see right side)										• Four USB 2.0 ports				
Multicard reader	5-in-1 reader (MultiMediaCard, Memory Stick, Mem Stick Pro, Secure Digital, SDHC)										• Gigabit ethernet port				
ExpressCard/54	One slot (ExpressCard/34, ExpressCard/54)										• Microphone in and headphone out				
Ports	Three USB 2.0, external monitor (VGA DB-15), modem (RJ-11), ethernet (RJ-45)										• Second battery charger				
Mini PCI Express	Three Mini PCI Express slots										• Requires 65 or 90 watt AC adapter				
Intel 5100 ²⁸	Some: 11a/b/g/n wireless ⁴ , Mini PCIe adapter, Intel WiFi Link 5100, 1x2 (Shirley Peak)										• 1.6 lb; 730g				
Intel 5300 ²⁸	Some: 11a/b/g/n wireless ⁴ , Mini PCIe adapter, Intel WiFi Link 5300, 3x3 (Shirley Peak)														
WiMAX	Some: 11a/b/g/n and WiMAX wireless ⁴ , Mini PCIe adap, Intel WiMAX/WiFi Link 5350, 3x3 (450Mbps) WiFi + 1x2 WiMAX (Echo Peak)														
WWAN upg	Some: Wireless WAN upgradable, requires Verizon® (43R9151) or AT&T® (43R9152)														
AT&T ²³	Some: Wireless WAN, Ericsson chipset, Mini PCIe adapter and SIM, GPRS/WCDMA/HSPA, GPS, service contract required with AT&T														
2G Turbo	Some: Intel Turbo Memory, Half-Mini PCIe adapter, 2GB flash, disk-cache accelerator														
UWB	None														
Modem	56K V.92 ⁶ modem														
Bluetooth™	Bluetooth 2.0 wireless, LED indicator														
Ethernet	Intel 82567LM Gigabit Network Connection (Boazman), PHY, PCIe x1														
Intel AMT	Some: Intel Active Management Technology (IAMT 4.0)														
Audio support	High Definition (HD) Audio, AD1984HD codec / mono speakers, 1 watt / volume up, down, mute buttons / digital microphone, microphone input jack, headphone jack														
Security	Power-on password, hard disk password, supervisor password, security keyhole														
Security chip	Trusted Platform Module, integrated in ICH9M, TCG 1.2-compliant														
Fingerprint reader	Fingerprint reader on palm rest, swipe sensor, supports the security chip														
Limited warranty ¹²	1-year - EasyServ™ depot repair service / service upgrades ²² available														
2GB PC3-8500 DDR3 SODIMM (TopSeller)	43R2046				X200 Series Li-Ion Battery 9-cell	43R9255									
128GB SSD SATA 3.0Gb/s 1.8" (2.5" cover)	43N3406				90W Slim AC/DC Combo Adapter	41N8460									
USB 2.0 Super Multi-Burner Drive	41N5565				ThinkVision® L2440p Wide 24" Monitor	4420HB2									
Other accessories on O-X200 sheet											Other accessories at lenovo.com/accessories				

See footnotes for important warranty information

◊ Intel Centrino® 2 processor technology

☞ US models announced January 6, 2009; previous models on August 5 or September 2, 2008

☞ US model withdrawn effective September 2008

Proc- Type-model	essor GHz	Memory	Wide- screen display	Cam- era	Disk SATA GB ⁹ rpm	Optical in UltraBase	ThinkPad X200 UltraBase	Mini PCIe 802.11 wireless	Mini PCIe WWAN	Mini PCIe UWB or Turbo	Blue- tooth	Finger print reader	Bat- tery cells	Whorse (W) Pre- Gbl (G) TAA	Avail date
7458-5EU	P8600 2.40	2GB	12.1" WXGA		160GB 5400	Optional	Optional	Intel 5100 ²⁸			Blue	Finger	6	B32 W G	Aug 08
7458-5FU	P8600 2.40	2GB	12.1" WXGA		160GB 7200	Optional	Optional	Intel 5100			Blue	Finger	6	B32 W G	Aug 08
7458-69U	P8600 2.40	2GB	12.1" WXGA	Cam	160GB 5400	Optional	Optional	Intel 5300 ²⁸	WWAN upg	2G Turbo	Blue	Finger	6	B32 W G	Aug 08
7458-M2U	P8600 2.40	1GB	12.1" WXGA		160GB 5400	Optional	Optional	Intel 5100			Blue	Finger	4	B32 W G	Aug 08
7458-M3U	P8600 2.40	1GB	12.1" WXGA		160GB 5400	Optional	Optional	Intel 5100			Blue	Finger	6	B32 W G	Aug 08
7458-7DU	P8600 2.40	2GB	12.1" WXGA	Cam	160GB 7200	Optional	Optional	Intel 5300	WWAN upg	2G Turbo	Blue	Finger	6	B32	Aug 08
✗ 7458-X4U	P8600 2.40	2GB	12.1" WXGA		160GB 5400	Optional	Optional	Intel 5100	WWAN upg		Blue	Finger	6	B32 TAA	Aug 08
☞ 7458-5HU	P8600 2.40	4GB	12.1" WXGA		160GB 7200	Optional	Optional	Intel 5300	Verizon ¹⁶		Blue	Finger	9	B32 W	Sep 08
☞ 7458-7CU	P8600 2.40	4GB	12.1" WXGA		160GB 7200	Optional	Optional	Intel 5300	AT&T ²³		Blue	Finger	9	B32 W	Sep 08
☞ 7458-87U	P8600 2.40	2GB	12.1" WXGA		160GB 7200	Optional	Optional	Intel 5100			Blue	Finger	6	XP G	Sep 08
☞ 7458-88U	P8600 2.40	4GB	12.1" WXGA		160GB 7200	Optional	Optional	Intel 5300	AT&T		Blue	Finger	9	XP W	Sep 08
☞ 7458-89U	P8600 2.40	2GB	12.1" WXGA	Cam	160GB 5400	Optional	Optional	Intel 5300	Verizon		Blue	Finger	9	XP W	Sep 08
Positioning US Govt (TAA) ⁵ Processor	An ultraportable for the executive on the move; one spindle X4U: US Government model (Trade Act Agreement-compliant) Intel® Core™ 2 Duo processor P8600 with dual-core, Intel HD boost, 1066MHz system bus, and 3MB L2 cache														
Memory	1GB, 2GB, or 4GB std / 4GB max ⁷ / PC3-8500 1066MHz DDR3, non-parity, dual-channel capable, two 204-pin SO-DIMM sockets; <i>Italics:</i> standard memory in both sockets; no sockets available; <i>Non-italics:</i> standard memory in 1 socket; 1 socket available														
Diskette drive SATA Combo Ultrabay Slim SATA disk	None (use optional USB-based diskette drive) Option for ThinkPad X200 UltraBase Supports Ultrabay Slim devices in optional or standard X200 UltraBase (43R8781) 160GB ⁹ (5400 or 7200rpm) / SATA 1.5Gb/s, 9.5mm high, removable, upgradable, ThinkPad Shock Mounted Hard Drive, Active Protection System™, supports 2nd disk in optional or std X200 UltraBase														
Widescreen display Camera	12.1" (308mm) WXGA (1280x800) TFT color, anti-glare, CCFL backlight, 200 nits, 16:10 aspect ratio, 250:1 contrast ratio <i>Some:</i> camera on top of screen, 1.3-megapixel, fixed focus														
Graphics controller Graphics - external	Intel Graphics Media Accelerator 4500MHD (GMA 4500MHD), in GM45 External monitor support via analog VGA DB-15 connector / DisplayPort via UltraBase; Maximum external resolution: 2048x1536@75Hz (VGA)														
Keyboard TrackPoint® Touch pad ThinkLight™	Full-size, 89-key, ThinkVantage button, spill-resistant, mm Fn keys TrackPoint® pointing device, "Press-to-Select," Internet Scroll Bar ¹³ , magnifying glass None Illuminates the keyboard to improve visibility in low-light conditions														
Dimensions ³ Weight ² Case color Case material Battery - type Battery - life ¹⁰	<i>without X200 UltraBase; 4-cell:</i> 11.6" x 8.3" x 0.8-1.4"; 295mm x 210mm x 21-35mm <i>without X200 UltraBase; 9-cell:</i> 11.6" x 9.2" x 0.8-1.4"; 295mm x 234mm x 21-35mm <i>4-cell:</i> from 2.98 lb (1.35kg); <i>6-cell:</i> from 3.26 lb (1.48kg); <i>9-cell:</i> from 3.61 lb (1.64kg) Black Magnesium alloy Lithium Ion 4-cell, 6-cell, or 9-cell <i>4-cell:</i> up to 3.3 hr; <i>6-cell:</i> up to 6.5 hr; <i>9-cell:</i> up to 9.8 hr														
Chipset	Mobile Intel GM45 Express Chipset (Graphics Memory Controller Hub), ICH9M-Enhanced I/O Controller Hub (SATA 3.0Gb/s, USB 2.0, PCI Express® 1.1, PCI 2.3, security chip, ethernet MAC)														
Media slice Multicard reader ExpressCard/54 Ports	Option: ThinkPad X200 UltraBase media slice (see right side) 5-in-1 reader (MultiMediaCard, Memory Stick, Mem Stick Pro, Secure Digital, SDHC) One slot (ExpressCard/34, ExpressCard/54) Three USB 2.0, external monitor (VGA DB-15), modem (RJ-11), ethernet (RJ-45)														
Mini PCI Express Intel 5100 ²⁸ Intel 5300 ²⁸ WWAN upg Verizon ¹⁶ AT&T ²³ 2G Turbo UWB Modem Bluetooth™ Ethernet Intel AMT Audio support	Three Mini PCI Express slots <i>Some:</i> 11a/b/g/n wireless ⁴ , Mini PCIe adapter, Intel WiFi Link 5100, 1x2 (Shirley Peak) <i>Some:</i> 11a/b/g/n wireless ⁴ , Mini PCIe adapter, Intel WiFi Link 5300, 3x3 (Shirley Peak) <i>Some:</i> Wireless WAN upgradable, requires Verizon® (43R9151) or AT&T® (43R9152) <i>Some:</i> Wireless WAN, Qualcomm chipset, Mini PCIe adapter and SIM, EV-DO Rev. A, GPRS/WCDMA/HSPA, GPS, service contract reqd with Verizon <i>Some:</i> Wireless WAN, Ericsson chipset, Mini PCIe adapter and SIM, GPRS/WCDMA/HSPA, GPS, service contract required with AT&T <i>Some:</i> Intel Turbo Memory, Half-Mini PCIe adapter, 2GB flash, disk-cache accelerator None 56K V.92 ⁶ modem <i>Some:</i> Bluetooth 2.0 wireless, LED indicator Intel 82567LM Gigabit Network Connection (Boazman), PHY, PCIe x1 Intel Active Management Technology (IAMT 4.0) High Definition (HD) Audio, AD1984HD codec / mono speakers, 1 watt / volume up, down, mute buttons / digital microphone, microphone input jack, headphone jack														
Security Security chip Fingerprint reader	Power-on password, hard disk password, supervisor password, security keyhole Trusted Platform Module, integrated in ICH9M, TCG 1.2-compliant <i>Some:</i> Fingerprint reader on palm rest, swipe sensor, supports the security chip														
Limited warranty ¹²	3-years/1-yr battery - EasyServ™ ¹⁹ depot repair service / service upgrades ²² available														
2GB PC3-8500 DDR3 SODIMM 320GB Disk SATA 1.5Gb/s (5400 rpm) USB 2.0 Ultra Secure Memory Key 8GB Other accessories on O-X200 sheet	43R1988 43N3403 45J5918	90W Slim AC/DC Combo Adapter ThinkPad Ultraportable Case X200 Series 12W Privacy Filter Other accessories at lenovo.com/accessories	41N8460 41U5062 43R2470												
Preloaded operating system ²⁰ - <i>Some:</i> Microsoft® Windows® XP Professional with Vista® COA - <i>Some:</i> Microsoft Windows Vista Business Edition (32-bit) ☞ Vista Premium logo Preloaded applications ¹⁴ (all OSes; only some listed) • Rescue and Recovery™ • Access Connections™ • ThinkVantage Productivity Center • ThinkVantage System Update • McAfee VirusScan® Plus with SiteAdvisor™ (30 days of virus definitions) • Microsoft Office 2007 Trial (60-day) • Roxio® Creator® Business Edition															
Supports ThinkVantage® technologies ThinkPad X200 UltraBase™ • Provides desktop expansion and cable management for X200 Series • Easily connects to the bottom of the X200 Series for traveling • Converts ThinkPad to a two-spindle system with optional Ultrabay Slim accessories in right side: - CD-RW/DVD-ROM Ultrabay Slim SATA 1.5Gb/s 43N3213 - DVD Burner Ultrabay Slim SATA 1.5Gb/s 43N3214 - Blu-ray™ Burner Ultrabay Slim SATA 1.5Gb/s 43N3215 - Serial Hard Drive Ultrabay Slim Adapter II 43R1980 Disks supported (some): • 200GB FDE 7200 rpm 41N5738 • 320GB Disk 5400 rpm 43R3403 Other features: • Power button (front) • Stereo speakers (2 watt) • Security key lock, security keyhole, and optional security screw • Analog DB-15 monitor port • DisplayPort (supports single-link DVI-D via cable 45J7915) • Four USB 2.0 ports • Gigabit ethernet port • Microphone in and headphone out • Second battery charger • Requires 65 or 90 watt AC adapter • 1.6 lb; 730g															
65-watt (GMA graphics) AC Adapter Climate Savers® certified ENERGY STAR® 4.0-compliant EPEAT™ Silver rating ROHS-compliant International Warranty Service ¹⁷ 24 hour x 7 day ¹⁸ toll-free support during the warranty period ¹² via 800-426-7378															

See footnotes for important warranty information

☞ Intel Centrino® 2 with vPro™ technology

© Lenovo

☞ US model announced September 2, 2008; previous models on August 5, 2008

(MOC1-2) January 2009

✗ US model withdrawn effective August 2008

Proc- Type-model	essor GHz	Memory	Wide- screen display	Cam- era	Disk SATA GB ⁸ rpm	Optical in UltraBase	ThinkPad X200 UltraBase	Mini PCIe 802.11 wireless	Mini PCIe WWAN	Mini PCIe UWB or Turbo	Finger Bat- print tery cells	Whorse (W) Pre- Gbl (G) Avail date			
7458-8SU	P8600	2.40	2GB	12.1" WXGA	Cam 128GB SSD			Intel 5100 ²⁸	WWAN upg		6	XP	Dec08		
7458-8RU	P8600	2.40	2GB	12.1" WXGA	Cam 128GB SSD			Intel 5300 ²⁸	WWAN upg	Blue	Finger	6	B32	Dec08	
7458-8QU	P8600	2.40	2GB	12.1" WXGA	Cam 128GB SSD			WiMAX	WWAN upg	Blue	Finger	6	B32	Dec08	
7458-8PU	P8600	2.40	2GB	12.1" WXGA	128GB SSD			WiMAX	WWAN upg	Blue	Finger	6	B32	Dec08	
7458-7BU	P8600	2.40	2GB	12.1" WXGA	Cam 160GB 7200	Combo	UltraBase	WiMAX	WWAN upg	2G Turbo	Blue	Finger	9	U32 W	Dec08
Positioning Processor	An ultraportable for the executive on the move; one spindle Intel® Core™ 2 Duo processor P8600 with dual-core, Intel HD boost, 1066MHz system bus, and 3MB L2 cache														
Memory	2GB std / 4GB max ⁷ / PC3-8500 1066MHz DDR3, non-parity, dual-channel capable, two 204-pin SO-DIMM sockets; Non-italics: standard memory in 1 socket; 1 socket available														
Diskette drive	None (use optional USB-based diskette drive)														
SATA Combo	Some: CD-RW/DVD-ROM (43N3213), SATA 1.5Gb/s, removable from X200 UltraBase														
Ultrabay Slim	Supports Ultrabay Slim devices in optional or standard X200 UltraBase (43R8781)														
SATA disk	Some: 128GB ⁸ Solid State Drive (SSD) / SATA 3.0Gb/s, 1.8" wide, 8mm high														
	Some: 160GB ⁸ (7200 rpm) / SATA 1.5Gb/s, 2.5" wide, 9.5mm high, Active Protection System™														
	All: removable, upgradable, shock mounted storage, supports 2nd disk in optional or standard X200 UltraBase														
Widescreen display	12.1" (308mm) WXGA (1280x800) TFT color, anti-glare, CCFL backlight, 200 nits, 16:10 aspect ratio, 250:1 contrast ratio														
Camera	Some: camera on top of screen, 1.3-megapixel, fixed focus														
Graphics controller	Intel Graphics Media Accelerator 4500MHD (GMA 4500MHD), in GM45														
Graphics - external	External monitor support via analog VGA DB-15 connector / DisplayPort via UltraBase; Maximum external resolution: 2048x1536@75Hz (VGA)														
Keyboard	Full-size, 89-key, ThinkVantage button, spill-resistant, mm Fn keys														
TrackPoint®	TrackPoint® pointing device, "Press-to-Select," Internet Scroll Bar ¹³ , magnifying glass														
Touch pad	None														
ThinkLight™	Illuminates the keyboard to improve visibility in low-light conditions														
Dimensions ³	without X200 UltraBase; 4-cell: 11.6" x 8.3" x 0.8-1.4"; 295mm x 210mm x 21-35mm														
	without X200 UltraBase; 9-cell: 11.6" x 9.2" x 0.8-1.4"; 295mm x 234mm x 21-35mm														
	4-cell: from 2.98 lb (1.35kg); 6-cell: from 3.26 lb (1.48kg); 9-cell: from 3.61 lb (1.64kg)														
Weight ²															
Case color	Black														
Case material	Magnesium alloy														
Battery - type	Lithium Ion 6-cell or 9-cell														
Battery - life ¹⁰	4-cell: up to 3.3 hr; 6-cell: up to 6.5 hr; 9-cell: up to 9.8 hr														
Chipset	Mobile Intel GM45 Express Chipset (Graphics Memory Controller Hub), ICH9M-Enhanced I/O Controller Hub (SATA 3.0Gb/s, USB 2.0, PCI Express® 1.1, PCI 2.3, security chip, ethernet MAC)														
Media slice	Some: ThinkPad X200 UltraBase media slice (see right side)														
Multicard reader	5-in-1 reader (MultiMediaCard, Memory Stick, Mem Stick Pro, Secure Digital, SDHC)														
ExpressCard/54	One slot (ExpressCard/34, ExpressCard/54)														
Ports	Three USB 2.0, external monitor (VGA DB-15), modem (RJ-11), ethernet (RJ-45)														
Mini PCI Express	Three Mini PCI Express slots														
Intel 5100 ²⁸	Some: 11a/b/g/n wireless ⁴ , Mini PCIe adapter, Intel WiFi Link 5100, 1x2 (Shirley Peak)														
Intel 5300 ²⁸	Some: 11a/b/g/n wireless ⁴ , Mini PCIe adapter, Intel WiFi Link 5300, 3x3 (Shirley Peak)														
WiMAX	Some: 11a/b/g/n and WiMAX wireless ⁴ , Mini PCIe adap, Intel WiMAX/WiFi Link 5350, 3x3 (450Mbps) WiFi + 1x2 WiMAX (Echo Peak)														
WWAN upg	Some: Wireless WAN upgradable, requires Verizon® (43R9151) or AT&T® (43R9152)														
2G Turbo	Some: Intel Turbo Memory, Half-Mini PCIe adapter, 2GB flash, disk-cache accelerator														
UWB	None														
Modem	56K V.92 ⁶ modem														
Bluetooth™	Some: Bluetooth 2.0 wireless, LED indicator														
Ethernet	Intel 82567LM Gigabit Network Connection (Boazman), PHY, PCIe x1														
Intel AMT	Intel Active Management Technology (IAMT 4.0)														
Audio support	High Definition (HD) Audio, AD1984HD codec / mono speakers, 1 watt / volume up, down, mute buttons / digital microphone, microphone input jack, headphone jack														
Security	Power-on password, hard disk password, supervisor password, security keyhole														
Security chip	Trusted Platform Module, integrated in ICH9M, TCG 1.2-compliant														
Fingerprint reader	Some: Fingerprint reader on palm rest, swipe sensor, supports the security chip														
Limited warranty ¹²	3-years/1-yr battery - EasyServ™ ¹⁹ depot repair service / service upgrades ²² available														
1GB PC3-8500 DDR3 SODIMM						43R1987	X200 Series Li-Ion Battery 6-cell						43R9254		
2GB PC3-8500 DDR3 SODIMM						43R1988	X200 Series Li-Ion Battery 9-cell						43R9255		
128GB SSD SATA 3.0Gb/s 1.8" (2.5" cover)						43N3406	90W Slim AC/DC Combo Adapter						41N8460		
320GB Disk SATA 1.5Gb/s (5400 rpm)						43N3403	ThinkPad Business Topload Case						43R2476		
USB 2.0 Ultra Secure Memory Key 8GB						45J5918	ThinkPad Business Backpack						43R2482		
USB 2.0 Portable Secure 320GB Hard Disk						43R2019	X200 Series 12W Privacy Filter						43R2470		
USB 2.0 Super Multi-Burner Drive						41N5565	DisplayPort to Single-link DVI-D Cable						45J7915		
ThinkPad X200 UltraBase						43R8781	ThinkVision® L1940p Wide 19" Monitor						4424HB6		
Verizon WWAN UNDP Broadband						43R9151	ThinkVision L2240p Wide 22" Monitor						4422HB6		
AT&T WWAN HSPA Broadband Mini PCIe						43R9152	ThinkVision L2440p Wide 24" Monitor						4420HB2		
Other accessories on O-X200 sheet												Other accessories at lenovo.com/accessories			
											Preloaded operating system ²⁰				
											- Some: Microsoft® Windows® XP Professional with Vista® COA				
											- Some: Microsoft Windows Vista Business Edition (32-bit)				
											- Some: Microsoft Windows Vista Ultimate Edition (32-bit)				
											↳ Vista Premium logo				
											Preloaded applications ¹⁴ (all OSes; only some listed)				
											• Rescue and Recovery™				
											• Access Connections™				
											• Client Security Solution™				
											• ThinkVantage Productivity Center				
											• ThinkVantage System Update				
											• McAfee VirusScan® Plus with SiteAdvisor™ (30 days of virus definitions)				
											• PC-Doctor™ (diagnostics)				
											• ThinkPad Utilities (Power Manager and Presentation Director)				
											• Adobe® Reader				
											• Microsoft Office 2007 Trial (60-day)				
											• Roxio® Creator® Business Edition				
											Supports ThinkVantage® technologies				
											ThinkPad X200 UltraBase™				
											• Provides desktop expansion and cable management for X200 Series				
											• Easily connects to the bottom of the X200 Series for traveling				
											• Converts ThinkPad to a two-spindle system with optional Ultrabay Slim accessories in right side:				
											- CD-RW/DVD-ROM Ultrabay Slim				
											SATA 1.5Gb/s 43N3213				
											- DVD Burner Ultrabay Slim				
											SATA 1.5Gb/s 43N3214				
											- Blu-ray™ Burner Ultrabay Slim				
											SATA 1.5Gb/s 43N3215				
											- Serial Hard Drive Ultrabay Slim				
											Adapter II 43R1980				
											Disks supported (some):				
											• 200GB FDE 7200 rpm 41N5738				
											• 320GB Disk 5400 rpm 43R3403				
											Other features:				
											• Power button (front)				
											• Stereo speakers (2 watt)				
											• Security key lock, security keyhole, and optional security screw				
											• Analog DB-15 monitor port				
											• DisplayPort (supports single-link DVI-D via cable 45J7915)				
											• Four USB 2.0 ports				
											• Gigabit ethernet port				
											• Microphone in and headphone out				
											• Second battery charger				
											• Requires 65 or 90 watt AC adapter				
											• 1.6 lb; 730g				
											65-watt (GMA graphics) AC Adapter				
											Climate Savers® certified				
											ENERGY STAR® 4.0-compliant				
											EPEAT™ Silver rating				
											ROHS-compliant				
											International Warranty Service ¹⁷				
											24 hour x 7 day ¹⁸ toll-free support				
											during the warranty period ¹²				
											via 800-426-7378				

See footnotes for important warranty information
US models announced December 2 or December 9, 2008

↳ Intel Centrino® 2 with vPro™ technology

Proc- Type-model	essor GHz	Mem- ory GB	Wide- screen display	Cam- era	Disk SATA GB ³	Optical in rpm	ThinkPad X200 UltraBase	Mini PCIe 802.11 wireless	Mini PCIe WWAN	Mini PCIe UWB or Turbo	Finger Bat- print tery reader cells	Whorse (W) Gbl (G) Avail Preload GMP (P) date
7459-M2U	P8600	2.40	1GB	12.1" WXGA	160GB	5400		✦ Intel 5100 ²⁸			4	Bus32 WGP Aug 08
7459-M3U	P8600	2.40	1GB	12.1" WXGA	160GB	5400		✦ Intel 5100			Finger 6	Bus32 WGP Aug 08
7459-5EU	P8600	2.40	2GB	12.1" WXGA	160GB	5400		✦ Intel 5100			6	Bus32 WGP Aug 08
7459-5FU	P8600	2.40	2GB	12.1" WXGA	160GB	7200		✦ Intel 5100			Finger 6	Bus32 WGP Aug 08
7459-69U	P8600	2.40	2GB	12.1" WXGA Cam	160GB	5400		✦ Intel 5300 ²⁸	WWAN upg	2G Turbo	Finger 6	Bus32 WGP Aug 08
7459-M4U	P8600	2.40	2GB	12.1" WXGA Cam	160GB	7200	Combo UltraBase	✦ WiMAX	WWAN upg		Finger 9	Ult 32 W Oct 08

• These models are part of the Global Models Plus program with limited onsite service²⁴ 3-year limited warranty

Positioning Processor	An ultraportable for the executive on the move; one spindle Intel® Core™ 2 Duo processor P8600 with dual-core, Intel HD boost, 1066MHz system bus, and 3MB L2 cache							Preloaded operating system²⁰ - Some: Microsoft® Windows® Vista® Business Edition (32-bit) - Some: Microsoft Windows Vista Ultimate Edition (32-bit) ✦ Vista Premium logo				
Memory	1GB or 2GB std / 4GB max ⁷ / PC3-8500 1066MHz DDR3 , non-parity, dual-channel capable, two 204-pin SO-DIMM sockets; <i>Italics:</i> standard memory in both sockets; no sockets available; <i>Non-italics:</i> standard memory in 1 socket; 1 socket available							Preloaded applications¹⁴ (all OSes) • Rescue and Recovery™ • Access Connections™ • Client Security Solution™ • ThinkVantage Productivity Center • ThinkVantage System Update • McAfee VirusScan® Plus with SiteAdvisor™ (30 days of virus definitions) • PC-Doctor™ (diagnostics) • ThinkPad Utilities (Power Manager and Presentation Director) • Adobe® Reader • Fingerprint Software (fingerprint models) • Windows Live™ Toolbar and Search • Microsoft Office 2007 Trial (60-day) • Roxio® Creator® Business Edition				
Diskette drive SATA Combo Ultrabay Slim SATA disk	None (use optional USB-based diskette drive) <i>Some:</i> CD-RW/DVD-ROM (43N3213), SATA 1.5Gb/s, removable from X200 UltraBase Supports Ultrabay Slim devices in optional ThinkPad X200 UltraBase (43R8781) 160GB³ (5400 or 7200rpm) / SATA 1.5Gb/s, 9.5mm high, removable, upgradable, ThinkPad Shock Mounted Hard Drive, Active Protection System™, supports 2nd disk in optional or std X200 UltraBase											
Widescreen display Camera	12.1" (308mm) WXGA (1280x800) TFT color , anti-glare, CCFL backlight, 200 nits, 16:10 aspect ratio, 250:1 contrast ratio <i>Some:</i> camera on top of screen, 1.3-megapixel, fixed focus											
Graphics controller Graphics - external	Intel Graphics Media Accelerator 4500MHD (GMA 4500MHD) , in GM45 External monitor support via analog VGA DB-15 connector / DisplayPort via UltraBase; <i>Maximum external resolution:</i> 2048x1536@75Hz (VGA)											
Keyboard TrackPoint® Touch pad ThinkLight™	Full-size, 89-key, ThinkVantage button, spill-resistant, mm Fn keys TrackPoint® pointing device, "Press-to-Select," Internet Scroll Bar ¹³ , magnifying glass None Illuminates the keyboard to improve visibility in low-light conditions											
Dimensions ³	<i>without X200 UltraBase; 4-cell:</i> 11.6" x 8.3" x 0.8-1.4"; 295mm x 210mm x 21-35mm <i>without X200 UltraBase; 9-cell:</i> 11.6" x 9.2" x 0.8-1.4"; 295mm x 234mm x 21-35mm <i>4-cell:</i> from 2.98 lb (1.35kg); <i>6-cell:</i> from 3.26 lb (1.48kg); <i>9-cell:</i> from 3.61 lb (1.64kg) <i>Color:</i> black; <i>Material:</i> magnesium alloy							Supports ThinkVantage® technologies ThinkPad X200 UltraBase™ • Provides desktop expansion and cable management for X200 Series • Easily connects to the bottom of the X200 Series for traveling • Converts ThinkPad to a two-spindle system with optional Ultrabay Slim accessories in right side: – CD-RW/DVD-ROM Ultrabay Slim SATA 1.5Gb/s 43N3213 – DVD Burner Ultrabay Slim SATA 1.5Gb/s 43N3214 – Blu-ray™ Burner Ultrabay Slim SATA 1.5Gb/s 43N3215 – Serial Hard Drive Ultrabay Slim Adapter II 43R1980 Disks supported (some): • 200GB FDE 7200 rpm 41N5738 • 320GB Disk 5400 rpm 43R3403				
Weight ² Case Battery - type Battery - life ¹⁰	<i>4-cell:</i> up to 3.3 hr; <i>6-cell:</i> up to 6.5 hr; <i>9-cell:</i> up to 9.8 hr											
Chipset	Mobile Intel GM45 Express Chipset (Graphics Memory Controller Hub), ICH9M-Enhanced I/O Controller Hub (SATA 3.0Gb/s, USB 2.0, PCI Express® 1.1, PCI 2.3, security chip, ethernet MAC)											
Media slice Multicard Reader ExpressCard slot Ports	<i>Some:</i> ThinkPad X200 UltraBase media slice (see right side) 5-in-1 reader (MultiMediaCard, Memory Stick, Mem Stick Pro, Secure Digital, SDHC) One ExpressCard/34 or ExpressCard/54 Three USB 2.0, external monitor (VGA DB-15), modem (RJ-11), ethernet (RJ-45)											
Mini PCI Express Intel 5100 ²⁸ Intel 5300 ²⁸ WiMAX WWAN upg 2G Turbo UWB Modem	Three Mini PCI Express slots <i>Some:</i> 11a/b/g/n wireless ⁴ , Mini PCIe adapter, Intel WiFi Link 5100, 1x2 (Shirley Peak) <i>Some:</i> 11a/b/g/n wireless ⁴ , Mini PCIe adapter, Intel WiFi Link 5300, 3x3 (Shirley Peak) <i>Some:</i> 11a/b/g/n and WiMAX wireless ⁴ , Mini PCIe adap, Intel WiMAX/WiFi Link 5350, 3x3 (450Mbps) WiFi + 1x2 WiMAX (Echo Peak) <i>Some:</i> Wireless WAN upgradable, requires Verizon® (43R9151) or AT&T® (43R9152) <i>Some:</i> Intel Turbo Memory, Half-Mini PCIe adapter, 2GB flash, disk-cache accelerator None 56K V.92 ⁶ modem											
Bluetooth™ Ethernet Intel AMT Audio support	Bluetooth 2.0 wireless, LED indicator Intel 82567LM Gigabit Network Connection (Boazman), PHY, PCIe x1 Intel Active Management Technology (IAMT 4.0) High Definition (HD) Audio, AD1984HD codec / mono speakers, 1 watt / volume up, down, mute buttons / digital microphone, microphone input jack, headphone jack											
Security Security chip Fingerprint reader	Power-on password, hard disk password, supervisor password, security keyhole Trusted Platform Module, integrated in ICH9M, TCG 1.2-compliant <i>Some:</i> Fingerprint reader on palm rest, swipe sensor, supports the security chip											
Limited warranty ¹²	3-years/1-year battery, limited onsite service²⁴ , 8 am - 5 pm, Mon - Fri coverage excluding holidays, next business day response time / service upgrades ²² available											
1GB PC3-8500 DDR3 SODIMM 2GB PC3-8500 DDR3 SODIMM 128GB SSD SATA 3.0Gb/s 1.8" (2.5" cover) 320GB Disk SATA 1.5Gb/s (5400 rpm) USB 2.0 Ultra Secure Memory Key 8GB USB 2.0 Super Multi-Burner Drive ThinkPad X200 UltraBase Verizon WWAN UNDP Broadband AT&T WWAN HSPA Broadband Mini PCIe Other accessories on O-X200 sheet	43R1987 43R1988 43N3406 43N3403 45J5918 41N5565 43R8781 43R9151 43R9152	X200 Series Li-Ion Battery 6-cell X200 Series Li-Ion Battery 9-cell 90W Slim AC/DC Combo Adapter ThinkPad Business Topload Case ThinkPad Business Backpack X200 Series 12W Privacy Filter ThinkVision® L1940p Wide 19" Monitor ThinkVision L2240p Wide 22" Monitor ThinkVision L2440p Wide 24" Monitor Other accessories at lenovo.com/accessories	43R9254 43R9255 41N8460 43R2476 43R2482 43R2470 4424HB6 4422HB6 4420HB2	Other features: • Power button (front) • Stereo speakers (2 watt) • Security key lock, security keyhole, and optional security screw • Analog DB-15 monitor port • DisplayPort (supports single-link DVI-D via cable 45J7915) • Four USB 2.0 ports • Gigabit ethernet port • Microphone in and headphone out • Second battery charger • Requires 65 or 90 watt AC adapter • 1.6 lb; 730g 65-watt (GMA graphics) AC Adapter Climate Savers® certified ENERGY STAR® 4.0-compliant EPEAT™ Silver rating ROHS-compliant International Warranty Service ¹⁷ 24 hour x 7 day ¹⁸ toll-free support during the warranty period ¹² via 800-426-7378								

See footnotes for important warranty information

✦ Intel Centrino® 2 with vPro™ technology

© Lenovo

☞ US model announced October 14, 2008; previous models on August 5, 2008

ThinkPad® X200 (7458) - Education (EasyServ)

Personal Systems Reference (PSREF)

Proc- Type-model	essor GHz	Memory	Wide- screen display	Cam- era	Disk SATA GB ^s	Optical in UltraBase	ThinkPad X200 UltraBase	Mini PCIe 802.11 wireless	Mini PCIe WWAN	Mini PCIe UWB or Turbo	Finger print reader	Bat- tery cells	Whorse (W) Gbl (G) Avail date
7458-E2U	P8600	2.40 2GB	12.1" WXGA	Cam	160GB	5400	Optional	Optional	Intel 5100 ²⁸	WWAN upg	None	Finger 6	Bus32 W Aug 08

• **This model has an EasyServ™,19 depot repair service 3-year limited warranty**

Educational models are available only to public or private K-12 or higher accredited schools organized and operated exclusively for educational purposes for use by qualified students and teachers.

Positioning Processor	An ultraportable for the executive on the move; one spindle Intel® Core™ 2 Duo processor P8600 with dual-core, Intel HD boost, 1066MHz system bus, and 3MB L2 cache										Preloaded operating system ²⁰ - Microsoft® Windows® Vista® Business Edition (32-bit) ↔ Vista Premium logo
Memory	2GB std / 4GB max ⁷ / PC3-8500 1066MHz DDR3, non-parity, dual-channel capable, two 204-pin SO-DIMM sockets; Non-italics: standard memory in 1 socket; 1 socket available										Preloaded applications ¹⁴ (only some listed)
Diskette drive SATA DVD±RW Ultrabay Slim SATA disk	None (use optional USB-based diskette drive) Option for ThinkPad X200 UltraBase Supports Ultrabay Slim devices in optional ThinkPad X200 UltraBase (43R8781) 160GB ⁸ (5400 rpm) / SATA 1.5Gb/s, 9.5mm high, removable, upgradeable, ThinkPad Shock Mounted Hard Drive, Active Protection System™, supports 2nd disk in optional or std X200 UltraBase										<ul style="list-style-type: none"> Education software - Microsoft Office OneNote® 2007 (and CD) - VitalSource Library College Edition - Adobe® Instructor Resource Cntr - Adobe Digital School Collection <ul style="list-style-type: none"> - Photoshop Elements (and CD) - Premier Elements (and DVD) - Acrobat 8 Professional - Contribute 4 Rescue and Recovery™ Client Security Solution™ ThinkVantage System Update McAfee VirusScan® Plus with SiteAdvisor™ (30 days of virus definitions) Microsoft Office 2007 Trial (60-day)
Widescreen display Camera	12.1" (308mm) WXGA (1280x800) TFT color, anti-glare, CCFL backlight, 200 nits, 16:10 aspect ratio, 250:1 contrast ratio Camera on top of screen, 1.3-megapixel, fixed focus										Supports ThinkVantage® technologies
Graphics controller Graphics - external	Intel Graphics Media Accelerator 4500MHD (GMA 4500MHD), in GM45 External monitor support via analog VGA DB-15 connector / DisplayPort via UltraBase Maximum external resolution: 2048x1536 @ 75Hz										
Keyboard TrackPoint® Touch pad ThinkLight™	Full-size, 89-key, ThinkVantage button, spill-resistant, mm Fn keys TrackPoint® pointing device, "Press-to-Select," Internet Scroll Bar ¹³ , magnifying glass None Illuminates the keyboard to improve visibility in low-light conditions										ThinkPad X200 UltraBase™ <ul style="list-style-type: none"> Provides desktop expansion and cable management for X200 Series Easily connects to the bottom of the X200 Series for traveling Converts ThinkPad to a two-spindle system with optional Ultrabay Slim accessories in right side: <ul style="list-style-type: none"> - CD-RW/DVD-ROM Ultrabay Slim SATA 1.5Gb/s 43N3213 - DVD Burner Ultrabay Slim SATA 1.5Gb/s 43N3214 - Blu-ray™ Burner Ultrabay Slim SATA 1.5Gb/s 43N3215 - Serial Hard Drive Ultrabay Slim Adapter II 43R1980 Disks supported (some): <ul style="list-style-type: none"> • 200GB FDE 7200 rpm 41N5738 • 320GB Disk 5400 rpm 43R3403
Dimensions ³ Weight ² Case Battery - type Battery - life ¹⁰	without X200 UltraBase; 4-cell: 11.6" x 8.3" x 0.8-1.4"; 295mm x 210mm x 21-35mm without X200 UltraBase; 9-cell: 11.6" x 9.2" x 0.8-1.4"; 295mm x 234mm x 21-35mm 6-cell: from 3.26 lb (1.48kg); 9-cell: from 3.61 lb (1.64kg) Color: black; Material: magnesium alloy Lithium Ion 6-cell 6-cell: up to 6.5 hr; 9-cell: up to 9.8 hr										
Chipset	Mobile Intel GM45 Express Chipset (Graphics Memory Controller Hub), ICH9M-Enhanced I/O Controller Hub (SATA 3.0Gb/s, USB 2.0, PCI Express® 1.1, PCI 2.3, security chip, ethernet MAC)										Other features: <ul style="list-style-type: none"> • Power button (front) • Stereo speakers (2 watt) • Security key lock, security keyhole, and optional security screw • Analog DB-15 monitor port • DisplayPort (supports single-link DVI-D via cable 45J7915) • Four USB 2.0 ports • Gigabit ethernet port • Microphone in and headphone out • Second battery charger • Requires 65 or 90 watt AC adapter • 1.6 lb; 730g
Media slice Multicard Reader ExpressCard slot Ports	Option: ThinkPad X200 UltraBase media slice (see right side) 5-in-1 reader (MultiMediaCard, Memory Stick, Mem Stick Pro, Secure Digital, SDHC) One ExpressCard/34 or ExpressCard/54 Three USB 2.0, external monitor (VGA DB-15), modem (RJ-11), ethernet (RJ-45)										
Mini PCI Express Intel 5100 ²⁸ WWAN upg 2G Turbo UWB Modem Bluetooth™ Ethernet Intel AMT Audio support	Three Mini PCI Express slots 11a/b/g/n wireless ⁴ , Mini PCIe adapter, Intel WiFi Link 5100, 1x2 (Shirley Peak) Wireless WAN upgradeable, requires Verizon® (43R9151) or AT&T® (43R9152) None None 56K V.92 ⁵ modem Bluetooth 2.0 wireless, LED indicator Intel 82567LM Gigabit Network Connection (Boazman), PHY, PCIe x1 Intel Active Management Technology (IAMT 4.0) High Definition (HD) Audio, AD1984HD codec / mono speakers, 1 watt / volume up, down, mute buttons / digital microphone, microphone input jack, headphone jack										<ul style="list-style-type: none"> • Security keyhole, and optional security screw • Analog DB-15 monitor port • DisplayPort (supports single-link DVI-D via cable 45J7915) • Four USB 2.0 ports • Gigabit ethernet port • Microphone in and headphone out • Second battery charger • Requires 65 or 90 watt AC adapter • 1.6 lb; 730g
Security Security chip Fingerprint reader	Power-on password, hard disk password, supervisor password, security keyhole Trusted Platform Module, integrated in ICH9M, TCG 1.2-compliant Fingerprint reader on palm rest, swipe sensor, supports the security chip										
Limited warranty ¹²	3-years/1-yr battery - EasyServ™,19 depot repair service / service upgrades ²² available										<ul style="list-style-type: none"> • 65-watt (GMA graphics) AC Adapter • Climate Savers® certified • ENERGY STAR® 4.0-compliant • EPEAT™ Silver rating • ROHS-compliant • International Warranty Service¹⁷ • 24 hour x 7 day¹⁸ toll-free support during the warranty period¹² via 800-426-7378
1GB PC3-8500 DDR3 SODIMM 2GB PC3-8500 DDR3 SODIMM Serial ATA Hard Drive Bay Adapter II SATA 128GB SSD SATA 3.0Gb/s 1.8" (2.5" cover) 320GB Disk SATA 1.5Gb/s (5400 rpm) USB 2.0 Security Memory Key 4GB USB 2.0 Ultra Secure Memory Key 8GB USB 2.0 Super Multi-Burner Drive USB 2.0 Security Memory Key 4GB ThinkPad X200 UltraBase Verizon WWAN UNDP Broadband AT&T WWAN HSPA Broadband Mini PCIe Laser Tilt Wheel Travel Mouse (Bluetooth) Other accessories on O-X200 sheet	43R1987 43R1988 43R1980 43N3406 43N3403 41U5120 45J5918 41N5565 43R8770 43R8781 43R9151 43R9152 41U5008	X200 Series Li-Ion Battery 4-cell X200 Series Li-Ion Battery 6-cell X200 Series Li-Ion Battery 9-cell 90W Slim AC/DC Combo Adapter ThinkPad Ultraportable Case ThinkPad Business Topload Case ThinkPad Business Backpack X200 Series 12W Privacy Filter ThinkVision® USB Soundbar (up to 22") ThinkVision L1700p 17" Monitor ThinkVision L1940p Wide 19" Monitor ThinkVision L2240p Wide 22" Monitor ThinkVision L2440x Wide 24" Monitor Other accessories at lenovo.com/accessories	43R9253 43R9254 43R9255 41N8460 41U5062 43R2476 43R2482 43R2470 40Y7616 9417HE2 4424HB6 4422HB6 4421HB2								

See footnotes for important warranty information
US models announced August 5, 2008

↔ Intel Centrino® 2 with vPro™ technology

© Lenovo
(MOC1-4) November 2008

ThinkPad® X200 (7459) - Education (Onsite)

Personal Systems Reference (PSREF)

Proc- Type-model	essor GHz	Memory	Wide- screen display	Cam- era	Disk SATA GB ^s	Optical in UltraBase	ThinkPad X200 UltraBase	Mini PCIe 802.11 wireless	Mini PCIe WWAN	Mini PCIe UWB or Turbo	Finger print reader	Bat- tery cells	Whorse (W) Gbl (G) Avail date
7459-E3U	P8600	2.40 2GB	12.1" WXGA	Cam	160GB	5400	Optional	Optional	❖Intel 5100 ²⁸	WWAN upg	None	None	6 Bus32 W Aug08

• **This model has a limited onsite service²⁴ 3-year limited warranty**

Educational models are available only to public or private K-12 or higher accredited schools organized and operated exclusively for educational purposes for use by qualified students and teachers.

Positioning Processor	An ultraportable for the executive on the move; one spindle Intel Core 2 Duo processor P8600 with dual-core, Intel HD boost, 1066MHz system bus, and 3MB L2 cache										Preloaded operating system²⁰ - Microsoft® Windows® Vista® Business Edition (32-bit) ❖ Vista Premium logo
Memory	2GB std / 4GB max ⁷ / PC3-8500 1066MHz DDR3 , non-parity, dual-channel capable, two 204-pin SO-DIMM sockets; <i>Non-italics:</i> standard memory in 1 socket; 1 socket available										Preloaded applications¹⁴ (only some listed)
Diskette drive SATA DVD±RW Ultrabay Slim SATA disk	None (use optional USB-based diskette drive) Option for <i>ThinkPad X200 UltraBase</i> Supports Ultrabay Slim devices in optional <i>ThinkPad X200 UltraBase</i> (43R8781) 160GB⁸ (5400 rpm) / SATA 1.5Gb/s, 9.5mm high, removable, upgradable, ThinkPad Shock Mounted Hard Drive, Active Protection System™, supports 2nd disk in optional or std <i>X200 UltraBase</i>										<ul style="list-style-type: none"> Education software - Microsoft Office OneNote® 2007 (and CD) - VitalSource Library College Edition - Adobe® Instructor Resource Cntr - Adobe Digital School Collection - Photoshop Elements (and CD) - Premier Elements (and DVD) - Acrobat 8 Professional - Contribute 4 • Rescue and Recovery™ • Client Security Solution™ • ThinkVantage System Update • McAfee VirusScan® Plus with SiteAdvisor™ (30 days of virus definitions) • Microsoft Office 2007 Trial (60-day)
Widescreen display Camera	12.1" (308mm) WXGA (1280x800) TFT color , anti-glare, CCFL backlight, 200 nits, 16:10 aspect ratio, 250:1 contrast ratio Camera on top of screen, 1.3-megapixel, fixed focus										
Graphics controller Graphics - external	Intel Graphics Media Accelerator 4500MHD (GMA 4500MHD) , in GM45 External monitor support via analog VGA DB-15 connector / DisplayPort via UltraBase <i>Maximum external resolution: 2048x1536 @ 75Hz</i>										<ul style="list-style-type: none"> • Supports ThinkVantage® technologies
Keyboard TrackPoint® Touch pad ThinkLight™	Full-size, 89-key, ThinkVantage button, spill-resistant, mm Fn keys TrackPoint® pointing device, "Press-to-Select," Internet Scroll Bar ¹³ , magnifying glass None Illuminates the keyboard to improve visibility in low-light conditions										<ul style="list-style-type: none"> • ThinkPad X200 UltraBase™
Dimensions ³	<i>without X200 UltraBase; 4-cell:</i> 11.6" x 8.3" x 0.8-1.4"; 295mm x 210mm x 21-35mm <i>without X200 UltraBase; 9-cell:</i> 11.6" x 9.2" x 0.8-1.4"; 295mm x 234mm x 21-35mm <i>6-cell:</i> from 3.26 lb (1.48kg); <i>9-cell:</i> from 3.61 lb (1.64kg) <i>Color:</i> black; <i>Material:</i> magnesium alloy										<ul style="list-style-type: none"> • Provides desktop expansion and cable management for X200 Series • Easily connects to the bottom of the X200 Series for traveling • Converts ThinkPad to a two-spindle system with optional Ultrabay Slim accessories in right side: <ul style="list-style-type: none"> - CD-RW/DVD-ROM Ultrabay Slim SATA 1.5Gb/s 43N3213 - DVD Burner Ultrabay Slim SATA 1.5Gb/s 43N3214 - Blu-ray™ Burner Ultrabay Slim SATA 1.5Gb/s 43N3215 - Serial Hard Drive Ultrabay Slim Adapter II 43R1980 • Disks supported (some): <ul style="list-style-type: none"> • 200GB FDE 7200 rpm 41N5738 • 320GB Disk 5400 rpm 43R3403
Weight ² Case Battery - type Battery - life ¹⁰	Lithium Ion 6-cell <i>6-cell:</i> up to 6.5 hr; <i>9-cell:</i> up to 9.8 hr										<ul style="list-style-type: none"> • Other features: <ul style="list-style-type: none"> • Power button (front) • Stereo speakers (2 watt) • Security key lock, security keyhole, and optional security screw • Analog DB-15 monitor port • DisplayPort (supports single-link DVI-D via cable 45J7915) • Four USB 2.0 ports • Gigabit ethernet port • Microphone in and headphone out • Second battery charger • Requires 65 or 90 watt AC adapter • 1.6 lb; 730g
Chipset	Mobile Intel GM45 Express Chipset (Graphics Memory Controller Hub), ICH9M-Enhanced I/O Controller Hub (SATA 3.0Gb/s, USB 2.0, PCI Express® 1.1, PCI 2.3, security chip, ethernet MAC)										
Media slice Multicard Reader ExpressCard slot Ports	<i>Option: ThinkPad X200 UltraBase media slice</i> (see right side) 5-in-1 reader (MultiMediaCard, Memory Stick, Mem Stick Pro, Secure Digital, SDHC) One ExpressCard/34 or ExpressCard/54 Three USB 2.0, external monitor (VGA DB-15), modem (RJ-11), ethernet (RJ-45)										
Mini PCI Express Intel 5100 ²⁸ WWAN upg 2G Turbo UWB Modem Bluetooth™ Ethernet Intel AMT Audio support	Three Mini PCI Express slots 11a/b/g/n wireless ⁴ , Mini PCIe adapter, Intel WiFi Link 5100, 1x2 (Shirley Peak) Wireless WAN upgradable, requires Verizon® (43R9151) or AT&T® (43R9152) None None 56K V.92 ⁶ modem Bluetooth 2.0 wireless, LED indicator Intel 82567LM Gigabit Network Connection (Boazman), PHY, PCIe x1 Intel Active Management Technology (IAMT 4.0) High Definition (HD) Audio, AD1984HD codec / mono speakers, 1 watt / volume up, down, mute buttons / digital microphone, microphone input jack, headphone jack										
Security Security chip Fingerprint reader	Power-on password, hard disk password, supervisor password, security keyhole Trusted Platform Module, integrated in ICH9M, TCG 1.2-compliant None										
Limited warranty ¹²	3-years/1-year battery, limited onsite service²⁴ , 8 am - 5 pm, Mon - Fri coverage excluding holidays, next business day response time/ service upgrades ²² available										
1GB PC3-8500 DDR3 SODIMM	43R1987		X200 Series Li-Ion Battery 4-cell						43R9253		
2GB PC3-8500 DDR3 SODIMM	43R1988		X200 Series Li-Ion Battery 6-cell						43R9254		
Serial ATA Hard Drive Bay Adapter II SATA	43R1980		X200 Series Li-Ion Battery 9-cell						43R9255		
128GB SSD SATA 3.0Gb/s 1.8" (2.5" cover)	43N3406		90W Slim AC/DC Combo Adapter						41N8460		
320GB Disk SATA 1.5Gb/s (5400 rpm)	43N3403		ThinkPad Ultraportable Case						41U5062		
USB 2.0 Security Memory Key 4GB	41U5120		ThinkPad Business Topload Case						43R2476		
USB 2.0 Ultra Secure Memory Key 8GB	45J5918		ThinkPad Business Backpack						43R2482		
USB 2.0 Super Multi-Burner Drive	41N5565		X200 Series 12W Privacy Filter						43R2470		
USB 2.0 Lenovo Enhanced Port Replicator	43R8770		ThinkVision® L1700p 17" Monitor						9417HE2		
ThinkPad X200 UltraBase	43R8781		ThinkVision L1940p Wide 19" Monitor						4424HB6		
Verizon WWAN UNDP Broadband	43R9151		ThinkVision L2240p Wide 22" Monitor						4422HB6		
AT&T WWAN HSPA Broadband Mini PCIe	43R9152		ThinkVision L2440p Wide 24" Monitor						4420HB2		
Other accessories on O-X200 sheet	Other accessories at lenovo.com/accessories										<ul style="list-style-type: none"> • 65-watt (GMA graphics) AC Adapter • Climate Savers® certified • ENERGY STAR® 4.0-compliant • EPEAT™ Silver rating • ROHS-compliant • International Warranty Service¹⁷ • 24 hour x 7 day¹⁸ toll-free support during the warranty period¹² via 800-426-7378

See footnotes for important warranty information
US models announced August 5, 2008

❖ Intel Centrino® 2 with vPro™ technology

© Lenovo
(MOC1-5) November 2008

ThinkPad®



Lenovo ThinkPad X200s



Lenovo ThinkPad X200s
with optional X200 UltraBase,
DVD Burner, and 9-cell Battery



Lenovo ThinkPad X200s



Lenovo ThinkPad X200s
with optional X200 UltraBase,
DVD Burner, and 9-cell Battery



Lenovo ThinkPad X200s



Lenovo ThinkPad X200s

ThinkPad® X200s (7466) - TopSeller

Type-model	Proc- essor	GHz	Memory	Widescreen display	Disk SATA GB ⁸	rpm	Optical in UltraBase	ThinkPad X200 UltraBase	Mini PCIe 802.11 wireless	Mini PCIe WWAN	Mini PCIe UWB or Turbo	Bat- tery Fing cells	Workhorse (W) Global (G)	Avail date	
7466-3GU	SL9400	1.86	4GB	12.1" WXGA+	160GB	7200	DVD±RW	UltraBase	Intel 5100 ²⁸	None	2G Turbo	Yes 9	Bus 32	No	Sep 08
7466-3HU	SL9400	1.86	2GB	12.1" WXGA+	160GB	7200			Intel 5100	None		Yes 6	XP Pro	No	Sep 08
7466-3JU	SL9400	1.86	4GB	12.1" WXGA+	160GB	7200	DVD±RW	UltraBase	Intel 5100	None		Yes 9	XP Pro	No	Sep 08

- Compared to the X200, the X200s has lighter weight, low voltage processors, LED backlight displays, and roll cage in display cover
- These small and medium business (SMB) models are part of the US TopSeller™ Program
- These models have a 3-years limited warranty

Positioning Processor	An ultraportable for the executive on the move; one spindle Intel® Core™ 2 Duo processor SL9400 with low voltage, dual-core, Intel HD Boost, 1066MHz system bus, and 6MB L2 cache											Preloaded operating system ²⁰ - Some: Microsoft® Windows® XP Professional with Vista® COA																																						
Memory	2GB or 4GB std / 4GB max ⁷ / PC3-8500 1066MHz DDR3, non-parity, dual-channel capable, two 204-pin SO-DIMM sockets; <i>Italics:</i> standard memory in both sockets; no sockets available; <i>Non-italics:</i> standard memory in 1 socket; 1 socket available											- Some: Microsoft Windows Vista Business Edition (32-bit) ◇ Vista Premium logo																																						
Diskette drive SATA DVD±RW Ultrabay Slim SATA disk	None (use optional USB-based diskette drive) <i>Some:</i> DVD burner (43N3214), SATA 1.5Gb/s, removable from X200 UltraBase Supports Ultrabay Slim devices in optional or standard X200 UltraBase (43R8781) 160GB ⁸ (7200 rpm) / SATA 1.5Gb/s, 9.5mm high, removable, upgradable, ThinkPad Shock Mounted Hard Drive, Active Protection System™, supports 2nd disk in optional or std X200 UltraBase											Preloaded applications ¹⁴ (all OSes; only some listed) • Rescue and Recovery™ • Access Connections™ • Client Security Solution™ • ThinkVantage System Update • McAfee VirusScan® Plus with SiteAdvisor™ (30 days of virus definitions) • Fingerprint Software • Windows Live™ Toolbar and Search • Microsoft Office 2007 Trial (60-day) • Roxio® Creator® Business Edition • Roxio MyDVD® (DVD±RW)																																						
Widescreen display Camera	12.1" (308mm) WXGA+ (1440x900) color, anti-glare, LED backlight, 250 nits, 16:10 aspect ratio, 300:1 contrast ratio None											Supports ThinkVantage® technologies ThinkPad X200 UltraBase™ • Provides desktop expansion and cable management for X200 Series • Easily connects to the bottom of the X200 Series for traveling • Converts ThinkPad to a two-spindle system with optional Ultrabay Slim accessories in right side: – CD-RW/DVD-ROM Ultrabay Slim SATA 1.5Gb/s 43N3213 – DVD Burner Ultrabay Slim SATA 1.5Gb/s 43N3214 – Blu-ray™ Burner Ultrabay Slim SATA 1.5Gb/s 43N3215 – Serial Hard Drive Ultrabay Slim Adapter II 43R1980 Disks supported (some): • 200GB FDE 7200 rpm 41N5738 • 320GB Disk 5400 rpm 43R3403 Other features: • Power button (front) • Stereo speakers (2 watt) • Security key lock, security keyhole, and optional security screw • Analog DB-15 monitor port • DisplayPort (supports single-link DVI-D via cable 45J7915) • Four USB 2.0 ports • Gigabit ethernet port • Microphone in and headphone out • Second battery charger • Requires 65 or 90 watt AC adapter • 1.6 lb; 730g																																						
Graphics controller Graphics - external	Intel Graphics Media Accelerator 4500MHD (GMA 4500MHD), in GS45 External monitor support via analog VGA DB-15 connector / DisplayPort via UltraBase; Maximum external resolution: 2048x1536@75Hz																																																	
Keyboard TrackPoint® Touch pad ThinkLight™	Full-size, 89-key, ThinkVantage button, spill-resistant, multimedia Fn keys TrackPoint® pointing device, "Press-to-Select," Internet Scroll Bar ¹³ , magnifying glass None Illuminates the keyboard to improve visibility in low-light conditions											Supports ThinkVantage® technologies ThinkPad X200 UltraBase™ • Provides desktop expansion and cable management for X200 Series • Easily connects to the bottom of the X200 Series for traveling • Converts ThinkPad to a two-spindle system with optional Ultrabay Slim accessories in right side: – CD-RW/DVD-ROM Ultrabay Slim SATA 1.5Gb/s 43N3213 – DVD Burner Ultrabay Slim SATA 1.5Gb/s 43N3214 – Blu-ray™ Burner Ultrabay Slim SATA 1.5Gb/s 43N3215 – Serial Hard Drive Ultrabay Slim Adapter II 43R1980 Disks supported (some): • 200GB FDE 7200 rpm 41N5738 • 320GB Disk 5400 rpm 43R3403 Other features: • Power button (front) • Stereo speakers (2 watt) • Security key lock, security keyhole, and optional security screw • Analog DB-15 monitor port • DisplayPort (supports single-link DVI-D via cable 45J7915) • Four USB 2.0 ports • Gigabit ethernet port • Microphone in and headphone out • Second battery charger • Requires 65 or 90 watt AC adapter • 1.6 lb; 730g																																						
Dimensions ³	without X200 UltraBase; 4-cell: 11.6" x 8.3" x 0.8-1.1"; 295mm x 210mm x 21-29mm without X200 UltraBase; 9-cell: 11.6" x 9.2" x 0.8-1.4"; 295mm x 234mm x 21-35mm 4-cell: from 2.43 lb (1.1kg); 6-cell: from 2.71 lb (1.23kg); 9-cell: from 3.05 lb (1.38kg)																																																	
Weight ² Case material	Color: black; Display cover: Carbon-fiber reinforced plastic (top), glass-fiber reinforced plastic (side walls); Base: Magnesium alloy																																																	
Battery - type Battery - life ¹⁰	Lithium Ion 6-cell or 9-cell 4-cell: up to 4.4 hr; 6-cell: up to 8.8 hr; 9-cell: up to 13.2 hr																																																	
Chipset	Mobile Intel GS45 Express Chipset (Graphics Memory Controller Hub), ICH9M-SFF-Enhanced I/O Controller Hub (SATA 3.0Gb/s, USB 2.0, PCI Express® 1.1, PCI 2.3, security chip, ethernet MAC)																																																	
Media slice Multicard Reader ExpressCard/54 Ports	<i>Some:</i> X200 UltraBase media slice (see right side) 5-in-1 reader (MultiMediaCard, Memory Stick, Mem Stick Pro, Secure Digital, SDHC) One slot (ExpressCard/34, ExpressCard/54) Three USB 2.0, external monitor (VGA DB-15), modem (RJ-11), ethernet (RJ-45)																																																	
Mini PCI Express Intel 5100 ²⁸ WWAN upg 2G Turbo UWB Modem Bluetooth™ Ethernet Intel AMT Audio support	Three Mini PCI Express slots 11a/b/g/n wireless ⁴ , Mini PCIe adapter, Intel WiFi Link 5100, 1x2 (Shirley Peak) None <i>Some:</i> Intel Turbo Memory, Half-Mini PCIe adapter, 2GB flash, disk-cache accelerator None 56K V.92 ⁶ modem Bluetooth 2.0 wireless, LED indicator Intel 82567LM Gigabit Network Connection (Boazman), PHY, PCIe x1 Intel Active Management Technology (IAMT 4.0) High Definition (HD) Audio, AD1984HD codec / mono speaker, 0.5 watt / volume up, down, mute buttons / digital microphone, microphone input jack, headphone jack																																																	
Security Security chip Fingerprint reader	Power-on password, hard disk password, supervisor password, security keyhole Trusted Platform Module, integrated in ICH9M, TCG 1.2-compliant Fingerprint reader on palm rest, swipe sensor, supports the security chip																																																	
Limited warranty ¹²	3-years/1-yr battery - EasyServ™ ¹⁹ depot repair service / service upgrades ²² available																																																	
1GB PC3-8500 DDR3 SODIMM (TopSeller)	43R2045	X200 Series Li-Ion Battery 4-cell	43R9253	2GB PC3-8500 DDR3 SODIMM (TopSeller)	43R2046	X200 Series Li-Ion Battery 6-cell	43R9254	Serial ATA Hard Drive Bay Adapter II SATA	43R1980	X200 Series Li-Ion Battery 9-cell	43R9255				128GB SSD SATA 3.0Gb/s 1.8" (2.5" cover)	43N3406	ThinkPad External Battery Charger	40Y7625	90W Slim AC/DC Combo Adapter	41N8460	320GB Disk SATA 1.5Gb/s (5400 rpm)	43N3403	ThinkPad Ultraportable Case	41U5062	USB 2.0 Essential Memory Key 32GB	45K1258	ThinkPad Business Topload Case	43R2476	USB 2.0 Ultra Secure Memory Key 8GB	45J5918	ThinkPad Business Backpack	43R2482	USB 2.0 Super Multi-Burner Drive	41N5565	X200 Series 12W Privacy Filter	43R2470	USB 2.0 Portable Secure 320GB Hard Disk	43R2019	ThinkVision® L1940p Wide 19" Monitor	4424HB6	ThinkPad X200 UltraBase	43R8781	ThinkVision L2240p Wide 22" Monitor	4422HB6	Wireless Kybd & Opt Wheel Mouse (USB)	73P4067	ThinkVision L2440p Wide 24" Monitor	4420HB2	Laser Tilt Wheel Travel Mouse (Bluetooth)	41U5008

See footnotes for important warranty information
US models announced September 23, 2008

◇ Intel Centrino® 2 with vPro™ technology

ThinkPad® X200s (7469)

Type-model	Proc- essor	GHz	Memory	Widescreen display	Disk SATA GB ³ rpm	Optical in UltraBase	ThinkPad X200 UltraBase	Mini PCIe 802.11 wireless	Mini PCIe WWAN	Mini PCIe UWB or Turbo	Bat- tery Blue/ Fing cells	Workhorse (W) Global (G)	Avail date
7469-5GU	SL9400	1.86	2GB	12.1" WXGA+	160GB 5400			◆ Intel 5100 ²⁸	None	None	Yes 6	Bus 32	G W Sep 08
7469-5HU	SL9400	1.86	2GB	12.1" WXGA+	160GB 7200			◆ Intel 5300 ²⁸	None	None	Yes 4	Bus 32	G W Sep 08
7469-5JU	SL9400	1.86	2GB	12.1" WXGA+	80GB SSD	Combo	UltraBase	◆ Intel 5100	None	None	Yes 6	XP Pro	W Dec 08
7469-74U	SL9400	1.86	2GB	12.1" WXGA+	80GB SSD			◆ Intel 5300	None	None	Yes 4	XP Pro	W Dec 08
7469-7YU	SL9300	1.60	2GB	12.1" WXGA+	128GB SSD			◆ WiMAX	None	None	Yes 6	Bus 32	Dec 08
7469-7ZU	SL9300	1.60	2GB	12.1" WXGA+	128GB SSD			◆ Intel 5100	None	None	Yes 4	Bus 32	Dec 08
7469-82U	SL9300	1.60	2GB	12.1" WXGA+	128GB SSD			◆ Intel 5300	None	None	Yes 6	XP Pro	Dec 08

• Compared to the X200, the X200s has lighter weight, low voltage processors, LED backlight displays, and roll cage in display cover

Positioning Processor	An ultraportable for the executive on the move; one spindle Intel® Core™ 2 Duo processor SL9300 or SL9400 with low voltage, dual-core , Intel HD Boost, 1066MHz system bus, and 6MB L2 cache	Preloaded operating system²⁰ - Some: Microsoft® Windows® XP Professional with Vista® COA
Memory	2GB std / 4GB max ⁷ / PC3-8500 1066MHz DDR3 , non-parity, dual-channel capable, two 204-pin SO-DIMM sockets; <i>Non-italics:</i> standard memory in 1 socket; 1 socket available	- Some: Microsoft Windows Vista Business Edition (32-bit) ◆ Vista Premium logo
Diskette drive SATA Combo Ultrabay Slim SATA disk	None (use optional USB-based diskette drive) <i>Some:</i> CD-RW/DVD-ROM (43N3213), SATA 1.5Gb/s, removable from X200 UltraBase Supports Ultrabay Slim devices in optional or standard X200 UltraBase (43R8781) <i>Some:</i> 80GB⁸ or 128GB Solid State Drive (SSD) / SATA 3.0Gb/s, 1.8" wide, 8mm high <i>Some:</i> 160GB⁸ (5400 or 7200 rpm) / SATA 1.5Gb/s, 2.5" wide, 9.5mm high, Active Protection System™ <i>All:</i> removable, upgradable, shock mounted storage, supports 2nd disk in optional or standard X200 UltraBase	Preloaded applications¹⁴ (all OSes; only some listed) • Rescue and Recovery™ • Access Connections™ • Client Security Solution™ • ThinkVantage Productivity Center • ThinkVantage System Update • McAfee VirusScan® Plus with SiteAdvisor™ (30 days of virus definitions) • ThinkPad Utilities • Windows Live™ Toolbar and Search • Microsoft Office 2007 Trial (60-day) • Roxio® Creator® Business Edition
Widescreen display Camera	12.1" (308mm) WXGA+ (1440x900) color , anti-glare, LED backlight , 250 nits, 16:10 aspect ratio, 300:1 contrast ratio None	
Graphics controller Graphics - external	Intel Graphics Media Accelerator 4500MHD (GMA 4500MHD) , in GS45 External monitor support via analog VGA DB-15 connector / DisplayPort via UltraBase; <i>Maximum external resolution:</i> 2048x1536 @ 75Hz	
Keyboard TrackPoint® Touch pad ThinkLight™	Full-size, 89-key, ThinkVantage button, spill-resistant, multimedia Fn keys TrackPoint® pointing device, "Press-to-Select," Internet Scroll Bar ¹³ , magnifying glass None Illuminates the keyboard to improve visibility in low-light conditions	Supports ThinkVantage® technologies
Dimensions ³ Weight ² Case color Case material	<i>without X200 UltraBase; 4-cell:</i> 11.6" x 8.3" x 0.8-1.1"; 295mm x 210mm x 21-29mm <i>without X200 UltraBase; 9-cell:</i> 11.6" x 9.2" x 0.8-1.4"; 295mm x 234mm x 21-35mm <i>4-cell:</i> from 2.43 lb (1.1kg); <i>6-cell:</i> from 2.71 lb (1.23kg); <i>9-cell:</i> from 3.05 lb (1.38kg) Black <i>Display cover:</i> Carbon-fiber reinforced plastic (top), glass-fiber reinforced plastic (side walls); <i>Base:</i> Magnesium alloy	ThinkPad X200 UltraBase™ • Provides desktop expansion and cable management for X200 Series • Easily connects to the bottom of the X200 Series for traveling • Converts ThinkPad to a two-spindle system with optional Ultrabay Slim accessories in right side: – CD-RW/DVD-ROM Ultrabay Slim SATA 1.5Gb/s 43N3213 – DVD Burner Ultrabay Slim SATA 1.5Gb/s 43N3214 – Blu-ray™ Burner Ultrabay Slim SATA 1.5Gb/s 43N3215 – Serial Hard Drive Ultrabay Slim Adapter II 43R1980 Disks supported (some): • 200GB FDE 7200 rpm 41N5738 • 320GB Disk 5400 rpm 43R3403
Battery - type Battery - life ¹⁰	Lithium Ion 4-cell or 6-cell <i>4-cell:</i> up to 4.4 hr; <i>6-cell:</i> up to 8.8 hr; <i>9-cell:</i> up to 13.2 hr	
Chipset	Mobile Intel GS45 Express Chipset (Graphics Memory Controller Hub), ICH9M-SFF-Enhanced I/O Controller Hub (SATA 3.0Gb/s, USB 2.0, PCI Express® 1.1, PCI 2.3, security chip, ethernet MAC)	
Media slice Multicard reader ExpressCard/54 Ports	<i>Some:</i> ThinkPad X200 UltraBase media slice (see right side) 5-in-1 reader (MultiMediaCard, Memory Stick, Mem Stick Pro, Secure Digital, SDHC) One slot (ExpressCard/34, ExpressCard/54) Three USB 2.0, external monitor (VGA DB-15), modem (RJ-11), ethernet (RJ-45)	
Mini PCI Express Intel 5100 ²⁸ Intel 5300 ²⁸ WiMAX	Three Mini PCI Express slots <i>Some:</i> 11a/b/g/n wireless ⁴ , Mini PCIe adapter, Intel WiFi Link 5100, 1x2 (Shirley Peak) <i>Some:</i> 11a/b/g/n wireless ⁴ , Mini PCIe adapter, Intel WiFi Link 5300, 3x3 (Shirley Peak) <i>Some:</i> 11a/b/g/n and WiMAX wireless ⁴ , Mini PCIe adap, Intel WiMAX/WiFi Link 5350, 3x3 (450Mbps) WiFi + 1x2 WiMAX (Echo Peak)	
WWAN upg 2G Turbo UWB	None None None	
Modem Bluetooth™	56K V.92 ⁶ modem <i>Some:</i> Bluetooth 2.0 wireless, LED indicator	
Ethernet Intel AMT Audio support	Intel 82567LM Gigabit Network Connection (Boazman), PHY, PCIe x1 Intel Active Management Technology (iAMT 4.0) High Definition (HD) Audio, AD1984HD codec / mono speaker, 0.5 watt / volume up, down, mute buttons / digital microphone, microphone input jack, headphone jack	
Security Security chip Fingerprint reader	Power-on password, hard disk password, supervisor password, security keyhole Trusted Platform Module, integrated in ICH9M, TCG 1.2-compliant <i>Some:</i> Fingerprint reader on palm rest, swipe sensor, supports the security chip	
Limited warranty ¹²	3-years/1-yr battery - EasyServ™¹⁹ depot repair service / service upgrades²² available	

1GB PC3-8500 DDR3 SODIMM	43R1987	X200 Series Li-Ion Battery 6-cell	43R9254
2GB PC3-8500 DDR3 SODIMM	43R1988	X200 Series Li-Ion Battery 9-cell	43R9255
128GB SSD SATA 3.0Gb/s 1.8" (2.5" cover)	43N3406	90W Slim AC/DC Combo Adapter	41N8460
320GB Disk SATA 1.5Gb/s (5400 rpm)	43N3403	ThinkPad Ultraportable Case	41U5062
USB 2.0 Super Multi-Burner Drive	41N5565	X200 Series 12W Privacy Filter	43R2470
USB 2.0 Portable Secure 320GB Hard Disk	43R2019	ThinkVision® L2240p Wide 22" Monitor	4422HB6
Laser Tilt Wheel Travel Mouse (Bluetooth)	41U5008	ThinkVision L2440p Wide 24" Monitor	4420HB2
Other accessories on O-X200 sheet		Other accessories at lenovo.com/accessories	

65-watt (GMA graphics) AC Adapter
Climate Savers® certified
ENERGY STAR® 4.0-compliant
Next Generation ThinkPad Roll Cage (in display cover)
EPEAT™ Gold rating
ROHS-compliant
International Warranty Service¹⁷
24 hour x 7 day¹⁸ toll-free support during the warranty period¹² via 800-426-7378

See footnotes for important warranty information

◆ Intel Centrino® 2 with vPro™ technology

© Lenovo

® US models announced December 9, 2008; previous models on September 23, 2008

(PEC1-2) December 2008

Type-model	Proc- essor	GHz	Memory	Widescreen display	Disk SATA GB ³	rpm	Optical in UltraBase	ThinkPad X200 UltraBase	Mini PCIe 802.11 wireless	Mini PCIe WWAN	Mini PCIe UWB or Turbo	Bat- tery Blue/ Fing cells	Workhorse (W) Global (G) Preload GMP (P)	Avail date		
7470-5GU	SL9400	1.86	2GB	12.1" WXGA+	160GB	5400	Optional	Optional	✦ Intel 5100 ²⁸	None	None	Yes	6	Bus 32	W G P	Sep 08
7470-5HU	SL9400	1.86	2GB	12.1" WXGA+	160GB	7200	Optional	Optional	✦ Intel 5300 ²⁸	None	None	Yes	4	Bus 32	W G P	Sep 08
7470-6FU	SL9400	1.86	2GB	12.1" WXGA+	160GB	5400	Optional	Optional	✦ Intel 5100	None	None	Yes	6	Bus 32	W	Sep 08
7470-6GU	SL9400	1.86	2GB	12.1" WXGA+	80GB	5400	Optional	Optional	✦ Intel 5300	None	None	Yes	4	Bus 32	W	Sep 08
7470-6HU	SL9400	1.86	2GB	12.1" WXGA+	80GB	SSD	Optional	Optional	✦ Intel 5300	None	None	Yes	4	XP Pro	W	Dec 08

- Compared to the X200, the X200s has lighter weight, low voltage processors, LED backlight displays, and roll cage in display cover
- Some models are part of the Global Models Plus program with limited onsite service²⁴ 3-year limited warranty

Positioning Processor	An ultraportable for the executive on the move; one spindle Intel® Core™ 2 Duo processor SL9400 with low voltage, dual-core, Intel HD Boost, 1066MHz system bus, and 6MB L2 cache										Preloaded operating system ²⁰ - Some: Microsoft® Windows® XP Professional with Vista® COA				
Memory	2GB std / 4GB max ⁷ / PC3-8500 1066MHz DDR3, non-parity, dual-channel capable, two 204-pin SO-DIMM sockets; Non-italics: standard memory in 1 socket; 1 socket available										- Some: Microsoft Windows Vista Business Edition (32-bit) ✦ Vista Premium logo				
Diskette drive SATA DVD±RW Ultrabay Slim SATA disk	None (use optional USB-based diskette drive) Option for ThinkPad X200 UltraBase Supports Ultrabay Slim devices in optional or standard X200 UltraBase (43R8781) Some: 80GB ⁸ Solid State Drive (SSD) / SATA 3.0Gb/s, 1.8" wide, 8mm high Some: 80GB ⁸ (5400) or 160GB (5400 or 7200 rpm) / SATA 1.5Gb/s, 2.5" wide, 9.5mm high, Active Protection System™ All: removable, upgradable, shock mounted storage, supports 2nd disk in optional or standard X200 UltraBase										Preloaded applications ¹⁴ (all OSes; only some listed) • Rescue and Recovery™ • Access Connections™ • Client Security Solution™ • ThinkVantage Productivity Center • ThinkVantage System Update • McAfee VirusScan® Plus with SiteAdvisor™ (30 days of virus definitions) • ThinkPad Utilities • Windows Live™ Toolbar and Search • Microsoft Office 2007 Trial (60-day) • Roxio® Creator® Business Edition				
Widescreen display Camera	12.1" (308mm) WXGA+ (1440x900) color, anti-glare, LED backlight, 250 nits, 16:10 aspect ratio, 300:1 contrast ratio None										Supports ThinkVantage® technologies ThinkPad X200 UltraBase™ • Provides desktop expansion and cable management for X200 Series • Easily connects to the bottom of the X200 Series for traveling • Converts ThinkPad to a two-spindle system with optional Ultrabay Slim accessories in right side: - CD-RW/DVD-ROM Ultrabay Slim SATA 1.5Gb/s 43N3213 - DVD Burner Ultrabay Slim SATA 1.5Gb/s 43N3214 - Blu-ray™ Burner Ultrabay Slim SATA 1.5Gb/s 43N3215 - Serial Hard Drive Ultrabay Slim Adapter II 43R1980 Disks supported (some): • 200GB FDE 7200 rpm 41N5738 • 320GB Disk 5400 rpm 43R3403				
Graphics controller Graphics - external	Intel Graphics Media Accelerator 4500MHD (GMA 4500MHD), in GS45 External monitor support via analog VGA DB-15 connector / DisplayPort via UltraBase; Maximum external resolution: 2048x1536@75Hz														
Keyboard TrackPoint® Touch pad ThinkLight™	Full-size, 89-key, ThinkVantage button, spill-resistant, multimedia Fn keys TrackPoint® pointing device, "Press-to-Select," Internet Scroll Bar ¹³ , magnifying glass None Illuminates the keyboard to improve visibility in low-light conditions										Other features: • Power button (front) • Stereo speakers (2 watt) • Security key lock, security keyhole, and optional security screw • Analog DB-15 monitor port • DisplayPort (supports single-link DVI-D via cable 45J7915) • Four USB 2.0 ports • Gigabit ethernet port • Microphone in and headphone out • Second battery charger • Requires 65 or 90 watt AC adapter • 1.6 lb; 730g				
Dimensions ³	without X200 UltraBase; 4-cell: 11.6" x 8.3" x 0.8-1.1"; 295mm x 210mm x 21-29mm without X200 UltraBase; 9-cell: 11.6" x 9.2" x 0.8-1.4"; 295mm x 234mm x 21-35mm 4-cell: from 2.43 lb (1.1kg); 6-cell: from 2.71 lb (1.23kg); 9-cell: from 3.05 lb (1.38kg)														
Weight ² Case color Case material	Black Display cover: Carbon-fiber reinforced plastic (top), glass-fiber reinforced plastic (side walls); Base: Magnesium alloy														
Battery - type Battery - life ¹⁰	Lithium Ion 4-cell or 6-cell 4-cell: up to 4.4 hr; 6-cell: up to 8.8 hr; 9-cell: up to 13.2 hr														
Chipset	Mobile Intel GS45 Express Chipset (Graphics Memory Controller Hub), ICH9M-SFF-Enhanced I/O Controller Hub (SATA 3.0Gb/s, USB 2.0, PCI Express® 1.1, PCI 2.3, security chip, ethernet MAC)														
Media slice Multicard reader ExpressCard/54 Ports	Option: ThinkPad X200 UltraBase media slice (see right side) 5-in-1 reader (MultiMediaCard, Memory Stick, Mem Stick Pro, Secure Digital, SDHC) One slot (ExpressCard/34, ExpressCard/54) Three USB 2.0, external monitor (VGA DB-15), modem (RJ-11), ethernet (RJ-45)														
Mini PCI Express Intel 5100 ²⁸ Intel 5300 ²⁸ WWAN upg 2G Turbo UWB	Three Mini PCI Express slots Some: 11a/b/g/n wireless ⁴ , Mini PCIe adapter, Intel WiFi Link 5100, 1x2 (Shirley Peak) Some: 11a/b/g/n wireless ⁴ , Mini PCIe adapter, Intel WiFi Link 5300, 3x3 (Shirley Peak) None None None														
Modem Bluetooth™ Ethernet Intel AMT Audio support	56K V.92 ⁵ modem Bluetooth 2.0 wireless, LED indicator Intel 82567LM Gigabit Network Connection (Boazman), PHY, PCIe x1 Intel Active Management Technology (IAMT 4.0) High Definition (HD) Audio, AD1984HD codec / mono speaker, 0.5 watt / volume up, down, mute buttons / digital microphone, microphone input jack, headphone jack														
Security Security chip Fingerprint reader	Power-on password, hard disk password, supervisor password, security keyhole Trusted Platform Module, integrated in ICH9M, TCG 1.2-compliant Fingerprint reader on palm rest, swipe sensor, supports the security chip														
Limited warranty ¹²	3-years/1-year battery, limited onsite service ²⁴ , 8 am - 5 pm, Mon - Fri coverage excluding holidays, next business day response time/ service upgrades ²² available														
1GB PC3-8500 DDR3 SODIMM 2GB PC3-8500 DDR3 SODIMM 128GB SSD SATA 3.0Gb/s 1.8" (2.5" cover) 320GB Disk SATA 1.5Gb/s (5400 rpm) USB 2.0 Ultra Secure Memory Key 8GB USB 2.0 Super Multi-Burner Drive USB 2.0 Portable Secure 320GB Hard Disk Laser Tilt Wheel Travel Mouse (Bluetooth) Other accessories on O-X200 sheet	43R1987 43R1988 43N3406 43N3403 45J5918 41N5565 43R2019 41U5008	X200 Series Li-Ion Battery 6-cell X200 Series Li-Ion Battery 9-cell 90W Slim AC/DC Combo Adapter ThinkPad Ultraportable Case ThinkPad Business Topload Case X200 Series 12W Privacy Filter ThinkVision® L2240p Wide 22" Monitor ThinkVision L2440p Wide 24" Monitor Other accessories at lenovo.com/accessories	43R9254 43R9255 41N8460 41U5062 43R2476 43R2470 4422HB6 4420HB2	65-watt (GMA graphics) AC Adapter Climate Savers® certified ENERGY STAR® 4.0-compliant Next Generation ThinkPad Roll Cage (in display cover) EPEAT™ Gold rating ROHS-compliant International Warranty Service ¹⁷ 24 hour x 7 day ¹⁸ toll-free support during the warranty period ¹² via 800-426-7378											

See footnotes for important warranty information
✦ Intel Centrino® 2 with vPro™ technology
US model announced December 9, 2008; previous models on September 23, 2008

Partial list of accessories supported on:

- ThinkPad X200 originally announced on **August 5, 2008**
- ThinkPad X200s originally announced on **September 23, 2008**

Memory

1GB PC3-8500 DDR3 SODIMM (TopSeller)	43R2045	ann 11/04/08
1GB PC3-8500 DDR3 SODIMM	43R1987	ann 08/05/08
2GB PC3-8500 DDR3 SODIMM (TopSeller)	43R2046	ann 11/04/08
2GB PC3-8500 DDR3 SODIMM	43R1988	ann 08/05/08

Ultrabay Slim 9.5mm

Most Ultrabay Slim accessories supported in ThinkPad X200 UltraBase

Storage and removable storage

160GB Disk SATA 1.5Gb/s (5400 rpm) ⁴¹	41N5692	ann 03/20/07
160GB Disk SATA 1.5Gb/s (7200 rpm) ⁴¹	41N5737	ann 10/16/07
200GB Disk FDE SATA 1.5Gb/s (7200 rpm) ⁴¹	41N5738	ann 10/16/07
250GB Disk SATA 1.5Gb/s (5400 rpm) ⁴¹	43R8152	ann 01/15/08
320GB Disk SATA 1.5Gb/s (5400 rpm) ⁴¹	43N3403	ann 08/05/08

⁴¹ Can be used as the main HDD or with *Serial ATA Hard Drive Bay Adapter 43R1980* in X200 UltraBase (43R8781)

128GB SSD SATA 3.0Gb/s 1.8" (2.5" cover)	43N3406	ann 08/26/08
USB 2.0 Essential Memory Key 2GB	41U4944	ann 01/23/07
USB 2.0 Essential Memory Key 4GB	45J7904	ann 06/24/08
USB 2.0 Essential Memory Key 8GB	45J7905	ann 07/15/08
USB 2.0 Essential Memory Key 32GB	45K1258	ann 10/28/08
USB 2.0 Security Memory Key 2GB	41U5119	ann 07/17/07
USB 2.0 Security Memory Key 4GB	41U5120	ann 07/17/07
USB 2.0 Ultra Secure Memory Key 1GB	45J5915	ann 08/26/08
USB 2.0 Ultra Secure Memory Key 2GB	45J5916	ann 08/26/08
USB 2.0 Ultra Secure Memory Key 4GB	45J5917	ann 08/26/08
USB 2.0 Ultra Secure Memory Key 8GB	45J5918	ann 08/26/08
USB Portable Diskette Drive	05K9276	ann 06/05/00
USB 2.0 CD-RW/DVD-ROM Combo II Drive	40Y8637	ann 01/05/06
USB 2.0 Portable 160GB Hard Disk	43R1784	ann 09/23/08
USB 2.0 Portable Secure 160GB Hard Disk	43R2018	ann 11/18/08
USB 2.0 Portable Secure 320GB Hard Disk	43R2019	ann 11/18/08
USB 2.0 Super Multi-Burner Drive	41N5565	ann 01/23/07

Wireless WAN (Mini PCI Express)

Verizon WWAN UNDP Broadband Mini PCIe ⁴²	43R9151	ann 08/05/08
AT&T® WWAN HSPA Broadband Mini PCIe ⁴²	43R9152	ann 08/26/08

⁴² Supported only in select models

ThinkPad Expansion

USB 2.0 Lenovo Enhanced Port Replicator	43R8770	ann 02/26/08
ThinkPad Adjustable Notebook Stand	40Y7676	ann 09/20/05
ThinkPad X200 UltraBase	43R8781	ann 08/05/08

Keyboard

TrackPoint Cap Collection	73P2698	ann 12/16/03
USB Numeric Keypad	33L3225	ann 05/01/00
Preferred Pro USB Keyboard	73P5220	ann 06/21/05
Enhanced Performance USB Keyboard	73P2620	ann 03/23/04
Wireless Kybd & Opt Wheel Mouse (via USB)	73P4067	ann 12/07/04
USB Keyboard with UltraNav	31P8950	ann 01/28/03
USB Travel Keyboard with UltraNav	31P9490	ann 04/27/04
Lenovo USB Fingerprint Keyboard	73P4730	ann 02/22/05

Mouse

Optical Wheel Mouse (USB)	06P4069	ann 05/21/03
Optical ScrollPoint® Mouse (USB, PS/2)	31P7405	ann 08/27/02
Optical Wheel Travel Mouse (USB, PS/2)	31P7410	ann 06/04/02
Laser Tilt Wheel Mouse (USB, PS/2)	41U3074	ann 01/23/07
Lenovo Wireless Laser Mouse (blk, via USB)	45K1696	ann 11/25/08
Lenovo Wireless Laser Mouse (red, via USB)	51J0198	ann 11/25/08
Laser Tilt Wheel Travel Mouse (Bluetooth)	41U5008	ann 01/22/08

Security

Kensington® Cable Lock from Lenovo	73P2582	ann 12/29/03
Kensington Twin Head Cable Lock	45K1620	ann 09/30/08
ThinkPad X200 Series 12W Privacy Filter	43R2470	ann 08/05/08
USB Gemplus GemPC Smart Card Reader	41N3040	ann 02/21/06
PC Card Gemplus Smart Card Reader	41N3004	ann 12/13/05
ExpressCard Gemplus Smart Card Reader	41N3043	ann 06/27/06

Multimedia

USB 2.0 Lenovo Multimedia Headset	40Y8518	ann 06/27/06
USB 2.0 Lenovo Webcam	40Y8519	ann 08/29/06

Batteries

X200 Series Li-Ion Battery 4-cell	43R9253	ann 08/05/08
X200 Series Li-Ion Battery 6-cell	43R9254	ann 08/05/08
X200 Series Li-Ion Battery 9-cell	43R9255	ann 08/05/08
ThinkPad External Battery Charger ⁴⁴	40Y7625	ann 09/20/05

⁴⁴ Requires the *ThinkPad 90W AC Adapter 40Y7659* (adapter provided with some systems).

More information at www.lenovo.com/alldaycomputing

ThinkPad 65W AC Adapter ⁴⁵	40Y7696	ann 01/05/06
---------------------------------------	---------	--------------

⁴⁵ Only compatible with the GM45 chipset models.

ThinkPad 90W AC Adapter	40Y7659	ann 09/20/05
ThinkPad 90W Slim AC/DC Combo Adapter	41N8460	ann 11/27/07

More info at www.lenovo.com/support/poweradapters

Charging tips for 90W Slim AC/DC Combo Adapter 41N8460

• Dual (ThinkPad+Phone) Charging Y-Cable	41R4345	ann 12/18/07
• iPod and iPhone charge tip (L10a)	41R4481	ann 12/18/07

More information at www.lenovo.com/support/slimadaptertips

Carrying Cases

Up to 13.3" widescreen models:

ThinkPad Ultraportable Case	41U5062	ann 05/13/08
-----------------------------	---------	--------------

Up to 14.1" widescreen models:

ThinkPad Expander Case	43R9118	ann 06/24/08
ThinkPad Women's Microfiber Tote	22P8855	
ThinkPad Women's Leather Trim Tote	22P8856	
ThinkPad Convertible Carrying Case	22P8860	
ThinkPad Women's Executive Leather Tote	22P8857	
Women's Executive Red Leather Tote	22P8858	

Up to 15.4" widescreen models:

Lenovo Carrying Case - Messenger Max	41U5253	ann 05/01/07
Lenovo Carr Case - Performance BackPack	41U5254	ann 05/01/07
Lenovo Standard Case	45K1697	ann 11/25/08
Lenovo Standard Backpack	45K1698	ann 11/25/08
ThinkPad Business Topload Case	43R2476	ann 05/13/08
ThinkPad Business Backpack	43R2482	ann 05/13/08
ThinkPad Deluxe Expander Case	43R2478	ann 05/13/08
ThinkPad Executive Leather Case	43R2480	ann 05/13/08

Up to 17.0" widescreen models:

ThinkPad 17W Business Topload Case	43R9117	ann 08/12/08
------------------------------------	---------	--------------

Lenovo luxury cases at www.lenovoluxurycases.com

Monitors

ThinkVision® L174 17" Monitor	9227AE1	ann 04/15/08
ThinkVision L1700p 17" Monitor	9417HE2	ann 09/17/08
ThinkVision L1900p 19" Monitor	4431HE1	ann 11/11/08
ThinkVision L1940p Wide 19" Monitor	4424HB6	ann 09/17/08
ThinkVision L200p Wide 20.1" Monitor	4438HB6	ann 04/15/08
ThinkVision L2240p Wide 22" Monitor	4422HB6	ann 09/17/08
ThinkVision L2440p Wide 24" Monitor	4420HB2	ann 09/17/08
ThinkVision L2440x Wide 24" Monitor	4421HB2	ann 09/17/08

Monitor Accessories⁴⁶

DisplayPort to Single-link DVI-D Cable	45J7915	ann 08/05/08
ThinkVision USB Soundbar	40Y7616	ann 08/23/05
ThinkVision Soundbar	45K1263	ann 09/16/08
Kensington Cable Lock from Lenovo	73P2582	ann 12/29/03
Kensington Twin Head Cable Lock	45K1620	ann 09/30/08
ThinkPad Convertible Monitor Stand	40Y7620	ann 01/05/06
Radial Arm	19K4464	ann 05/05/00

⁴⁶ Compatible on selected Lenovo and ThinkVision monitors.

More information at www.lenovo.com/support/monitoraccessories

Other accessories at www.lenovo.com/accessories

Accessories Guide pdf at www.lenovo.com/accessoriesguide



Lenovo ThinkPad X200 Tablet
with touchscreen for finger and pen



Lenovo ThinkPad X200 Tablet
with frameless screen for pen



Lenovo ThinkPad X200 Tablet
with touchscreen for finger and pen



Lenovo ThinkPad X200 Tablet
with frameless screen for pen



Lenovo X200 UltraBase



Lenovo X200 UltraBase
with optional DVD Burner

ThinkPad® X200 Tablet (7449) - TopSeller

Personal Systems Reference (PSREF)

Type-model	Proc- essor	GHz	Memory	Widescreen display	CCFL or LED Cam	Disk SATA GB ³ rpm	Optical in UltraBase	ThinkPad X200 UltraBase	Mini PCIe 802.11 wireless	Mini PCIe WWAN	Mini PCIe Bat- tery or Turbo cells	Preload	Avail date
7449-EKU	SL9400	1.86	4GB	12.1" WXGA	Touch LED Cam	160G 7200	DVD±RW	UltraBase	Intel 5100 ²⁸	AT&T ²³	2G Turbo	8 Bus 64	Oct 08
7449-88U	SL9400	1.86	2GB	12.1" WXGA	LED Cam	160G 7200	DVD±RW	UltraBase	Intel 5100	WWAN upg	2G Turbo	8 Bus 32	Oct 08
7449-9FU	SL9400	1.86	2GB	12.1" WXGA		160G 5400	DVD±RW	UltraBase	Intel 5100	WWAN upg		4 XP Tab	Oct 08
7449-8JU	SL9400	1.86	2GB	12.1" WXGA	LED Cam	160G 7200	DVD±RW	UltraBase	Intel 5100	WWAN upg		8 XP Tab	Oct 08
7449-9EU	SL9400	1.86	2GB	12.1" WXGA		160G 5400			Intel 5100	WWAN upg		4 XP Tab	Oct 08
7449-F9U	SL9400	1.86	2GB	12.1" WXGA	Touch LED	160G 5400			Intel 5100	WWAN upg		8 XP Tab	Oct 08
7449-84U	SL9400	1.86	4GB	12.1" WXGA	LED Cam	128G SSD	DVD±RW	UltraBase	Intel 5100	AT&T		8 XP Tab	Oct 08

• These small and medium business (SMB) models are part of the US TopSeller™ Program

Positioning	Convertible tablet ultraportable; one spindle	Preloaded operating system²⁰ - Some: Microsoft® Windows® XP Tablet PC Edition 2005 with Vista® COA - Some: Microsoft Windows Vista Business Edition (32-bit) - Some: Microsoft Windows Vista Business Edition (64-bit) ⇨ Vista Premium logo Preloaded applications¹⁴ (all OSes; only some listed) • Rescue and Recovery™ • Access Connections™ • Client Security Solution™ • ThinkVantage System Update • McAfee VirusScan® Plus with SiteAdvisor™ (30 days of virus definitions) • FingerPrint Software • Windows Live™ Toolbar and Search • Microsoft Office 2007 Trial (60-day) • Roxio® Creator® Business Edition • Roxio MyDVD® (DVD±RW) Supports ThinkVantage® technologies ThinkPad X200 UltraBase™ • Provides desktop expansion and cable management for X200 Series • Easily connects to the bottom of the X200 Series for traveling • Converts ThinkPad to a two-spindle system with optional Ultrabay Slim accessories in right side: – CD-RW/DVD-ROM Ultrabay Slim SATA 1.5Gb/s 43N3213 – DVD Burner Ultrabay Slim SATA 1.5Gb/s 43N3214 – Blu-ray™ Burner Ultrabay Slim SATA 1.5Gb/s 43N3215 – Serial Hard Drive Ultrabay Slim Adapter II 43R1980 Disks supported (some): • 200GB FDE 7200 rpm 41N5738 • 320GB Disk 5400 rpm 43R3403 Other features: • Power button (front) • Stereo speakers (2 watt) • Security key lock, security keyhole, and optional security screw • Analog DB-15 monitor port • DisplayPort (supports single-link DVI-D via cable 45J7915) • Four USB 2.0 ports • Gigabit ethernet port • Microphone in and headphone out • Second battery charger • Requires 65 or 90 watt AC adapter • 1.6 lb; 730g 65-watt (GMA graphics) AC Adapter Climate Savers® certified ENERGY STAR® 4.0-compliant EPEAT™ Gold rating (LED models) EPEAT Silver rating (other models) ROHS-compliant International Warranty Service ¹⁷ 24 hour x 7 day ¹⁸ toll-free support during the warranty period ¹² via 800-426-7378
Processor	Intel® Core™ 2 Duo processor SL9400 with low voltage, dual-core, Intel HD Boost, 1066MHz system bus, and 6MB L2 cache	
Memory	2GB or 4GB std / 4GB max ⁷ / PC3-8500 1066MHz DDR3, non-parity, dual-channel capable, two 204-pin SO-DIMM sockets; <i>Italics:</i> standard memory in both sockets; no sockets available; <i>Non-italics:</i> standard memory in 1 socket; 1 socket available	
Diskette drive	None (use optional USB-based diskette drive)	
SATA DVD±RW	Some: DVD burner (43N3214), SATA 1.5Gb/s, removable from X200 UltraBase	
Ultrabay Slim	Supports Ultrabay Slim devices in optional or standard X200 UltraBase (43R8781)	
SATA disk	Some: 128GB ⁸ Solid State Drive (SSD) / SATA 3.0Gb/s, 1.8" wide, 8mm high; Some: 160GB ⁸ (5400 or 7200 rpm) / SATA 1.5Gb/s, 2.5" wide, 9.5mm high, Active Protection System™ All: removable, upgradable, shock mounted storage, supports 2nd disk in optional or standard X200 UltraBase	
Widescreen display	Some: 12.1" (308mm) WXGA (1280x800) TFT color, anti-glare, CCFL backlight, 190 nits, 16:10 aspect ratio, 500:1 contrast ratio, FFS, frameless screen Some: 12.1" (308mm) WXGA (1280x800) TFT color, anti-glare, LED backlight, 285 nits, 16:10 aspect ratio, 500:1 contrast ratio, IPS, frameless screen Touch: 12.1" (308mm) WXGA (1280x800) TFT color, anti-glare, LED backlight, 230 nits, 16:10 aspect ratio, 500:1 contrast ratio, IPS, MultiView (indoor/outdoor), MultiTouch (touchscreen via finger and pen) All: WideView (170° viewing), anti-reflective and anti-glare protective coatings, write on screen with standard digitizer pen, pen holder in front base, rotatable dual swivel hinge for tablet mode (portrait or landscape) or picture frame mode (keyboard faces away from user), buttons on display bottom (power with slide-lock, reset, rotation, menu, all button lock)	
Camera	Some: camera on top of screen, 1.3-megapixel, fixed focus	
Graphics controller	Intel Graphics Media Accelerator 4500MHD (GMA 4500MHD), in GS45	
Graphics - external	External monitor support via analog VGA DB-15 connector / DisplayPort via UltraBase; Maximum external resolution: 2048x1536@75Hz (VGA)	
Keyboard	Full-size, 89-key, ThinkVantage button, spill-resistant, mm Fn keys	
TrackPoint®	TrackPoint® pointing device, "Press-to-Select," Internet Scroll Bar ¹³ , magnifying glass	
Touch pad	None	
ThinkLight™	None	
Dimensions ³	without X200 UltraBase; 4-cell: 11.6" x 9" x 1-1.3"; 295mm x 228mm x 26.5-33mm without X200 UltraBase; 8-cell: 11.6" x 10.1" x 1-1.3"; 295mm x 257mm x 26.5-33mm 4-cell: from 3.5 lb (1.6kg); 8-cell: from 3.88 lb (1.76kg)	
Weight ²		
Case	Color: black; Material: magnesium alloy	
Battery - type	Lithium Ion 4-cell or 8-cell	
Battery - life ¹⁰	4-cell: up to 4.4 hr; 8-cell: up to 10.3 hr	
Chipset	Mobile Intel GS45 Express Chipset (Graphics Memory Controller Hub), ICH9M-SFF-Enhanced I/O Controller Hub (SATA 3.0Gb/s, USB 2.0, PCI Express® 1.1, PCI 2.3, security chip, ethernet MAC)	
Media slice	Some: X200 UltraBase media slice (see right side)	
Multicard Reader	5-in-1 reader (MultiMediaCard, Memory Stick, Mem Stick Pro, Secure Digital, SDHC)	
ExpressCard/54	One slot (ExpressCard/34, ExpressCard/54)	
Ports	Three USB 2.0, external monitor (VGA DB-15), modem (RJ-11), ethernet (RJ-45)	
Mini PCI Express	Three Mini PCI Express slots	
Intel 5100 ²⁸	11a/b/g/n wireless ⁴ , Mini PCIe adapter, Intel WiFi Link 5100, 1x2 (Shirley Peak)	
WWAN upg	Some: Wireless WAN upgradable, requires Verizon® (43R9151) or AT&T® (43R9152)	
AT&T ²³	Some: Wireless WAN, Ericsson chipset, Mini PCIe adapter and SIM, GPRS/WCDMA/HSPA, GPS, service contract required with AT&T®	
2G Turbo	Some: Intel Turbo Memory, Half-Mini PCIe adapter, 2GB flash, disk-cache accelerator	
UWB	None	
Modem	56K V.92 ⁶ modem	
Bluetooth™	Bluetooth 2.0 wireless, LED indicator	
Ethernet	Intel 82567LM Gigabit Network Connection (Boazman), PHY, PCIe x1	
Intel AMT	Intel Active Management Technology (IAMT 4.0)	
Audio support	High Definition (HD) Audio, AD1984HD codec / stereo speakers, 2 watt / volume up, down, mute buttons / dual array microphone, microphone input jack, headphone jack	
Security	Power-on password, hard disk password, supervisor password, security keyhole	
Security chip	Trusted Platform Module, integrated in ICH9M, TCG 1.2-compliant	
Fingerprint reader	Fingerprint reader on palm rest, swipe sensor, supports the security chip	
Limited warranty ¹²	3-years/1-yr battery - EasyServ™ ¹⁹ depot repair service / service upgrades ²² available	
USB 2.0 Super Multi-Burner Drive	41N5565	Other accessories at lenovo.com/accessories

See footnotes for important warranty information

✦ Intel Centrino® 2 with vPro™ technology

Ⓢ US model announced October 14, 2008; previous models on September 23, 2008

© Lenovo
(CML1-1) October 2008

ThinkPad® X200 Tablet (7450)

Personal Systems Reference (PSREF)

Type-model	Proc- essor	GHz	Memory	Widescreen display	CCFL or LED	Cam	Disk SATA	Optical in	ThinkPad X200	Mini PCIe 802.11	Mini PCIe WWAN	Mini PCIe UWB or Turbo	Blue/ Fing	Workhorse (W) Global (G) Avail date
7450-2CU	SL9400	1.86	2GB	12.1" WXGA			160G 5400	Optional	Opt	❖ Intel 5100 ²⁸	WWAN upg			Bus 32 W G Oct 08
7450-28U	SL9300	1.60	2GB	12.1" WXGA		Cam	250G 5400	Optional	Opt	❖ Intel 5300 ²⁸	WWAN upg	2G Turbo	Yes	Bus 32 W G Oct 08
7450-EDU	SL9400	1.86	2GB	12.1" WXGA	LED		160G 7200	Optional	Opt	❖ Intel 5100	WWAN upg		Yes	Bus 32 W G Oct 08
7450-8HU	SL9400	1.86	2GB	12.1" WXGA	LED	Cam	160G 7200	Optional	Opt	❖ Intel 5100	WWAN upg		Yes	Bus 32 W G Oct 08
7450-9GU	SL9400	1.86	2GB	12.1" WXGA		Cam	160G 7200	Optional	Opt	❖ Intel 5300	WWAN upg		Yes	XP Tab W G Oct 08
7450-EYU	SL9300	1.60	2GB	12.1" WXGA	LED	Cam	160G 5400	Optional	Opt	❖ Intel 5300	WWAN upg		Yes	XP Tab Oct 08
7450-FDU	SL9400	1.86	2GB	12.1" WXGA	LED		160G 7200	Optional	Opt	❖ Intel 5100	WWAN upg		Yes	XP Tab W G Oct 08
Positioning Processor	<i>Convertible tablet ultraportable; one spindle</i> Intel® Core™ 2 Duo processor SL9300 or SL9400 with low voltage, dual-core , Intel HD Boost, 1066MHz system bus, and 6MB L2 cache												Preloaded operating system²⁰ - <i>Some:</i> Microsoft® Windows® XP Tablet PC Edition 2005 with Vista® COA - <i>Some:</i> Microsoft Windows Vista Business Edition (32-bit) ❖ Vista Premium logo	
Memory	2GB std / 4GB max ⁷ / PC3-8500 1066MHz DDR3 , non-parity, dual-channel capable, two 204-pin SO-DIMM sockets; <i>Non-italics:</i> standard memory in 1 socket; 1 socket available													
Diskette drive	None (use optional USB-based diskette drive)												Preloaded applications¹⁴ (all OSes; only some listed) • Rescue and Recovery™ • Access Connections™ • Client Security Solution™ • ThinkVantage System Update • McAfee VirusScan® Plus with SiteAdvisor™ (30 days of virus definitions) • PC-Doctor™ (diagnostics) • Fingerprint Software (fingerprint models) • Windows Live™ Toolbar and Search • Microsoft Office 2007 Trial (60-day) • Roxio® Creator® Business Edition • Roxio MyDVD® (DVD±RW)	
SATA DVD±RW	None													
Ultrabay Slim	Supports Ultrabay Slim devices in optional or standard <i>X200 UltraBase</i> (43R8781)													
SATA disk	160GB (5400 or 7200 rpm) or 250GB (5400 rpm) / SATA 1.5Gb/s, 9.5mm high, removable, upgradeable, ThinkPad Shock Mounted Hard Drive, Active Protection System™, supports 2nd disk in optional or std <i>X200 UltraBase</i>													
Widescreen display	<i>Some:</i> 12.1" (308mm) WXGA (1280x800) TFT color , anti-glare, CCFL backlight, 190 nits, 16:10 aspect ratio, 500:1 contrast ratio, FFS, frameless screen <i>Some:</i> 12.1" (308mm) WXGA (1280x800) TFT color , anti-glare, LED backlight , 285 nits, 16:10 aspect ratio, 500:1 contrast ratio, IPS, frameless screen <i>Touch:</i> 12.1" (308mm) WXGA (1280x800) TFT color , anti-glare, LED backlight , 230 nits, 16:10 aspect ratio, 500:1 contrast ratio, IPS, MultiView (indoor/outdoor), MultiTouch (touchscreen via finger and pen) <i>All:</i> WideView (170° viewing), anti-reflective and anti-glare protective coatings, write on screen with standard digitizer pen , pen holder in front base, rotatable dual swivel hinge for tablet mode (portrait or landscape) or picture frame mode (keyboard faces away from user), buttons on display bottom (power with slide-lock, reset, rotation, menu, all button lock)													
Camera	<i>Some:</i> camera on top of screen, 1.3-megapixel, fixed focus												Supports ThinkVantage® technologies	
Graphics controller	Intel Graphics Media Accelerator 4500MHD (GMA 4500MHD) , in GS45												ThinkPad X200 UltraBase™ • Provides desktop expansion and cable management for X200 Series • Easily connects to the bottom of the X200 Series for traveling • Converts ThinkPad to a two-spindle system with optional Ultrabay Slim accessories in right side: – CD-RW/DVD-ROM Ultrabay Slim SATA 1.5Gb/s 43N3213 – DVD Burner Ultrabay Slim SATA 1.5Gb/s 43N3214 – Blu-ray™ Burner Ultrabay Slim SATA 1.5Gb/s 43N3215 – Serial Hard Drive Ultrabay Slim Adapter II 43R1980 Disks supported (some): • 200GB FDE 7200 rpm 41N5738 • 320GB Disk 5400 rpm 43R3403	
Graphics - external	External monitor support via analog VGA DB-15 connector / DisplayPort via UltraBase; <i>Maximum external resolution:</i> 2048x1536 @75Hz													
Keyboard	Full-size, 89-key, ThinkVantage button, spill-resistant, mm Fn keys												Other features: • Power button (front) • Stereo speakers (2 watt) • Security key lock, security keyhole, and optional security screw • Analog DB-15 monitor port • DisplayPort (supports single-link DVI-D via cable 45J7915) • Four USB 2.0 ports • Gigabit ethernet port • Microphone in and headphone out • Second battery charger • Requires 65 or 90 watt AC adapter • 1.6 lb; 730g	
TrackPoint®	TrackPoint® pointing device, "Press-to-Select," Internet Scroll Bar ¹³ , magnifying glass													
Touch pad	None												65-watt (GMA graphics) AC Adapter Climate Savers® certified ENERGY STAR® 4.0-compliant EPEAT™ Gold rating (LED models) EPEAT Silver rating (other models) ROHS-compliant International Warranty Service ¹⁷ 24 hour x 7 day ¹⁸ toll-free support during the warranty period ¹² via 800-426-7378	
ThinkLight™	None													
Dimensions ³	<i>without X200 UltraBase; 4-cell:</i> 11.6" x 9" x 1-1.3"; 295mm x 228mm x 26.5-33mm <i>without X200 UltraBase; 8-cell:</i> 11.6" x 10.1" x 1-1.3"; 295mm x 257mm x 26.5-33mm													
Weight ²	<i>4-cell:</i> from 3.5 lb (1.6kg); <i>8-cell:</i> from 3.88 lb (1.76kg)													
Case	<i>Color:</i> black; <i>Material:</i> magnesium alloy													
Battery - type	Lithium Ion 8-cell													
Battery - life ¹⁰	<i>4-cell:</i> up to 4.4 hr; <i>8-cell:</i> up to 10.3 hr													
Chipset	Mobile Intel GS45 Express Chipset (Graphics Memory Controller Hub), ICH9M-SFF-Enhanced I/O Controller Hub (SATA 3.0Gb/s, USB 2.0, PCI Express® 1.1, PCI 2.3, security chip, ethernet MAC)													
Media slice	<i>Optional: X200 UltraBase media slice</i> (see right side)													
Multicard Reader	5-in-1 reader (MultiMediaCard, Memory Stick, Mem Stick Pro, Secure Digital, SDHC)													
ExpressCard/54	One slot (ExpressCard/34, ExpressCard/54)													
Ports	Three USB 2.0, external monitor (VGA DB-15), modem (RJ-11), ethernet (RJ-45)													
Mini PCI Express	Three Mini PCI Express slots													
Intel 5100 ²⁸	<i>Some:</i> 11a/b/g/n wireless ⁴ , Mini PCIe adapter, Intel WiFi Link 5100, 1x2 (Shirley Peak)													
Intel 5300 ²⁸	<i>Some:</i> 11a/b/g/n wireless ⁴ , Mini PCIe adapter, Intel WiFi Link 5300, 3x3 (Shirley Peak)													
WWAN upg	Wireless WAN upgradeable, requires Verizon® (43R9151) or AT&T® (43R9152)													
2G Turbo	<i>Some:</i> Intel Turbo Memory, Half-Mini PCIe adapter, 2GB flash, disk-cache accelerator													
UWB	None													
Modem	56K V.92 ⁶ modem													
Bluetooth™	<i>Some:</i> Bluetooth 2.0 wireless, LED indicator													
Ethernet	Intel 82567LM Gigabit Network Connection (Boazman), PHY, PCIe x1													
Intel AMT	Intel Active Management Technology (IAMT 4.0)													
Audio support	High Definition (HD) Audio, AD1984HD codec / stereo speakers, 2 watt / volume up, down, mute buttons / dual array microphone, microphone input jack, headphone jack													
Security	Power-on password, hard disk password, supervisor password, security keyhole													
Security chip	Trusted Platform Module, integrated in ICH9M, TCG 1.2-compliant													
Fingerprint reader	<i>Some:</i> Fingerprint reader on palm rest, swipe sensor, supports the security chip													
Limited warranty ¹²	3-years/1-yr battery - EasyServ™.19 depot repair service / service upgrades ²² available													
1GB PC3-8500 DDR3 SODIMM	43R1987	X200 Tablet Li-Ion Battery 8-cell		43R9257										
2GB PC3-8500 DDR3 SODIMM	43R1988	90W Slim AC/DC Combo Adapter		41N8460										
128GB SSD SATA 3.0Gb/s 1.8" (2.5" cover)	43N3406	ThinkPad Ultraportable Case		41U5062										
USB 2.0 Portable Secure 320GB Hard Disk	43R2019	ThinkVision® L2440x Wide 24" Monitor		4421HB2										
Other accessories on O-X200 sheet	Other accessories at lenovo.com/accessories													

See footnotes for important warranty information
US models announced September 23, 2008

❖ Intel Centrino® 2 with vPro™ technology

© Lenovo
(CML1-2) September 2008

Type-model	Proc- essor	GHz	Memory	Widescreen display	CCFL or LED	Disk SATA GB ⁹	Optical in rpm	ThinkPad X200 UltraBase	Mini PCIe 802.11 wireless	Mini PCIe WWAN	Mini PCIe UWB or Turbo	Bat- tery Blue/ Fing cells	Pre- load	Avail date
7450-8UU	SL94001	.86	2GB	12.1" WXGA	LED Cam	80GBSSD	DVD±RW	UltraBase	Intel 5300 ²⁸	AT&T ²³	None	Yes	8	Bus 32 Dec 08
7450-G9U	SL93001	.60	2GB	12.1" WXGA		128G SSD			Intel 5100 ²⁸	WWAN upg	None	Yes	4	Bus 32 Dec 08
7450-GDU	SL94001	.86	2GB	12.1" WXGA	LED Cam	128G SSD			Intel 5300	WWAN upg	None	Yes	8	Bus 32 Dec 08
7450-GEU	SL94001	.86	2GB	12.1" WXGA	Touch LED Cam	128G SSD			Intel 5300	WWAN upg	None	Yes	8	Bus 32 Dec 08
7450-GAU	SL94001	.86	2GB	12.1" WXGA		128G SSD			WiMAX	WWAN upg	None	Yes	8	Bus 32 Jan 09
7450-GBU	SL94001	.86	2GB	12.1" WXGA	LED Cam	128G SSD			WiMAX	WWAN upg	None	Yes	8	Bus 32 Jan 09
7450-GCU	SL94001	.86	2GB	12.1" WXGA	Touch LED Cam	128G SSD			WiMAX	WWAN upg	None	Yes	8	Bus 32 Jan 09
Positioning Processor	Convertible tablet ultraportable; one spindle Intel® Core™ 2 Duo processor SL9300 or SL9400 with low voltage, dual-core , Intel HD Boost, 1066MHz system bus, and 6MB L2 cache											Preloaded operating system²⁰ - Microsoft® Windows® Vista® Business Edition (32-bit) ◆ Vista Premium logo		
Memory	2GB std / 4GB max ⁷ / PC3-8500 1066MHz DDR3 , non-parity, dual-channel capable, two 204-pin SO-DIMM sockets; <i>Non-italics:</i> standard memory in 1 socket; 1 socket available											Preloaded applications¹⁴ • Rescue and Recovery™ • Access Connections™ • Client Security Solution™ • ThinkVantage Productivity Center • ThinkVantage System Update • McAfee VirusScan® Plus with SiteAdvisor™ (30 days of virus definitions) • PC-Doctor™ (diagnostics) • ThinkPad Utilities (Power Manager and Presentation Director) • Adobe® Reader • Fingerprint Software (fingerprint models) • Windows Live™ Toolbar and Search • Microsoft Office 2007 Trial (60-day) • Roxio® Creator® Business Edition • Roxio MyDVD® (DVD±RW)		
Diskette drive	None (use optional USB-based diskette drive)													
SATA DVD±RW	None													
Ultrabay Slim	Supports Ultrabay Slim devices in optional or standard <i>X200 UltraBase</i> (43R8781)													
SATA disk	80GB⁹ or 128GB Solid State Drive (SSD) / SATA 3.0Gb/s, 1.8" wide, 8mm high removable, upgradable, shock mounted storage, supports second disk in optional or standard <i>X200 UltraBase</i>													
Widescreen display	<i>Some:</i> 12.1" (308mm) WXGA (1280x800) TFT color , anti-glare, CCFL backlight, 190 nits, 16:10 aspect ratio, 500:1 contrast ratio, FFS, frameless screen <i>Some:</i> 12.1" (308mm) WXGA (1280x800) TFT color , anti-glare, LED backlight , 285 nits, 16:10 aspect ratio, 500:1 contrast ratio, IPS, frameless screen <i>Touch:</i> 12.1" (308mm) WXGA (1280x800) TFT color , anti-glare, LED backlight , 230 nits, 16:10 aspect ratio, 500:1 contrast ratio, IPS, MultiView (indoor/outdoor), MultiTouch (touchscreen via finger and pen) <i>All:</i> WideView (170° viewing), anti-reflective and anti-glare protective coatings, write on screen with standard digitizer pen , pen holder in front base, rotatable dual swivel hinge for tablet mode (portrait or landscape) or picture frame mode (keyboard faces away from user), buttons on display bottom (power with slide-lock, reset, rotation, menu, all button lock)													
Camera	<i>Some:</i> camera on top of screen, 1.3-megapixel, fixed focus													
Graphics controller	Intel Graphics Media Accelerator 4500MHD (GMA 4500MHD) , in GS45											Supports ThinkVantage® technologies		
Graphics - external	External monitor support via analog VGA DB-15 connector / DisplayPort via UltraBase; <i>Maximum external resolution:</i> 2048x1536@75Hz													
Keyboard	Full-size, 89-key, ThinkVantage button, spill-resistant, mm Fn keys													
TrackPoint®	TrackPoint® pointing device, "Press-to-Select," Internet Scroll Bar ¹³ , magnifying glass													
Touch pad	None													
ThinkLight™	None													
Dimensions ³	<i>without X200 UltraBase; 4-cell:</i> 11.6" x 9" x 1-1.3"; 295mm x 228mm x 26.5-33mm <i>without X200 UltraBase; 8-cell:</i> 11.6" x 10.1" x 1-1.3"; 295mm x 257mm x 26.5-33mm <i>4-cell:</i> from 3.5 lb (1.6kg); <i>8-cell:</i> from 3.88 lb (1.76kg)													
Weight ²														
Case color	Black													
Case material	Magnesium alloy													
Battery - type	Lithium Ion 4-cell or 8-cell													
Battery - life ¹⁰	<i>4-cell:</i> up to 4.4 hr; <i>8-cell:</i> up to 10.3 hr													
Chipset	Mobile Intel GS45 Express Chipset (Graphics Memory Controller Hub), ICH9M-SFF-Enhanced I/O Controller Hub (SATA 3.0Gb/s, USB 2.0, PCI Express® 1.1, PCI 2.3, security chip, ethernet MAC)													
Media slice	<i>Optional: X200 UltraBase media slice</i> (see right side)													
Multicard reader	5-in-1 reader (MultiMediaCard, Memory Stick, Mem Stick Pro, Secure Digital, SDHC)													
ExpressCard/54	One slot (ExpressCard/34, ExpressCard/54)													
Ports	Three USB 2.0, external monitor (VGA DB-15), modem (RJ-11), ethernet (RJ-45)													
Mini PCI Express	Three Mini PCI Express slots													
Intel 5100 ²⁸	<i>Some:</i> 11a/b/g/n wireless ⁴ , Mini PCIe adapter, Intel WiFi Link 5100, 1x2 (Shirley Peak)													
Intel 5300 ²⁸	<i>Some:</i> 11a/b/g/n wireless ⁴ , Mini PCIe adapter, Intel WiFi Link 5300, 3x3 (Shirley Peak)													
WiMAX	<i>Some:</i> 11a/b/g/n and WiMAX wireless ⁴ , Mini PCIe adap, Intel WiMAX/WiFi Link 5350, 3x3 (450Mbps) WiFi + 1x2 WiMAX (Echo Peak)													
WWAN upg	<i>Some:</i> Wireless WAN upgradable, requires Verizon® (43R9151) or AT&T® (43R9152)													
AT&T ²³	<i>Some:</i> Wireless WAN, Ericsson chipset, Mini PCIe adapter and SIM, GPRS/WCDMA/HSPA, GPS, service contract required with AT&T													
2G Turbo	None													
UWB	None													
Modem	56K V.92 ⁹ modem													
Bluetooth™	<i>Some:</i> Bluetooth 2.0 wireless, LED indicator													
Ethernet	Intel 82567LM Gigabit Network Connection (Boazman), PHY, PCIe x1													
Intel AMT	Intel Active Management Technology (IAMT 4.0)													
Audio support	High Definition (HD) Audio, AD1984HD codec / stereo speakers, 2 watt / volume up, down, mute buttons / dual array microphone, microphone input jack, headphone jack													
Security	Power-on password, hard disk password, supervisor password, security keyhole													
Security chip	Trusted Platform Module, integrated in ICH9M, TCG 1.2-compliant													
Fingerprint reader	<i>Some:</i> Fingerprint reader on palm rest, swipe sensor, supports the security chip													
Limited warranty ¹²	3-years/1-yr battery - EasyServ™ ¹⁹ depot repair service / service upgrades ²² available													
2GB PC3-8500 DDR3 SODIMM	43R1988		ThinkPad Ultraportable Case				41U5062							
Other accessories on O-X200 sheet			Other accessories at lenovo.com/accessories											

See footnotes for important warranty information

◆ Intel Centrino® 2 with vPro™ technology

© Lenovo

Ⓜ US models announced January 6, 2009; previous models December 9, 2008

(CML1-6) January 2009

ThinkPad® X200 Tablet (7453) - Onsite

Personal Systems Reference (PSREF)

Type-model	Proc- essor	GHz	Memory	Widescreen display	CCFL or LED	Cam	Disk SATA	Optical in	ThinkPad X200 UltraBase	Mini PCIe 802.11 wireless	Mini PCIe WWAN	Mini PCIe UWB Blue/ or Turbo Fing	Workhorse (W) Global (G) Avail date
7453-2CU	SL9400	1.86	2GB	12.1" WXGA			160G 5400	Optional	Opt	❖ Intel 5100 ²⁸	WWAN	upg None	Bus 32 W G P Oct 08
7453-EDU	SL9400	1.86	2GB	12.1" WXGA	Touch	LED	160G 7200	Optional	Opt	❖ Intel 5100	WWAN	upg None	Yes Bus 32 W Oct 08
7453-9GU	SL9400	1.86	2GB	12.1" WXGA		Cam	160G 7200	Optional	Opt	❖ Intel 5300 ²⁸	WWAN	upg None	Yes XP Tab W G P Oct 08
7453-FDU	SL9400	1.86	2GB	12.1" WXGA	Touch	LED	160G 7200	Optional	Opt	❖ Intel 5100	WWAN	upg None	Yes XP Tab W G P Oct 08
7453-8HU	SL9400	1.86	2GB	12.1" WXGA		LED Cam	160G 7200	Optional	Opt	❖ Intel 5100	WWAN	upg None	Yes Bus 32 W Oct 08
Positioning Processor	<i>Convertible tablet ultraportable; one spindle</i> Intel® Core™ 2 Duo processor SL9300 or SL9400 with low voltage, dual-core , Intel HD Boost, 1066MHz system bus, and 6MB L2 cache												
Memory	2GB std / 4GB max ⁷ / PC3-8500 1066MHz DDR3 , non-parity, dual-channel capable, two 204-pin SO-DIMM sockets; <i>Non-italics:</i> standard memory in 1 socket; 1 socket available												
Diskette drive SATA DVD±RW Ultrabay Slim SATA disk	None (use optional USB-based diskette drive) None Supports Ultrabay Slim devices in optional or standard <i>X200 UltraBase</i> (43R8781) 160GB⁸ (5400 or 7200 rpm) / SATA 1.5Gb/s, 9.5mm high, removable, upgradable, ThinkPad Shock Mounted Hard Drive, Active Protection System™, supports 2nd disk in optional or std <i>X200 UltraBase</i>												
Widescreen display	<i>Some:</i> 12.1" (308mm) WXGA (1280x800) TFT color , anti-glare, CCFL backlight, 190 nits, 16:10 aspect ratio, 500:1 contrast ratio, FFS, frameless screen <i>Some:</i> 12.1" (308mm) WXGA (1280x800) TFT color , anti-glare, LED backlight , 285 nits, 16:10 aspect ratio, 500:1 contrast ratio, IPS, frameless screen <i>Touch:</i> 12.1" (308mm) WXGA (1280x800) TFT color , anti-glare, LED backlight , 230 nits, 16:10 aspect ratio, 500:1 contrast ratio, IPS, MultiView (indoor/outdoor), MultiTouch (touchscreen via finger and pen) <i>All:</i> WideView (170° viewing), anti-reflective and anti-glare protective coatings, write on screen with standard digitizer pen , pen holder in front base, rotatable dual swivel hinge for tablet mode (portrait or landscape) or picture frame mode (keyboard faces away from user), buttons on display bottom (power with slide-lock, reset, rotation, menu, all button lock)												
Camera	<i>Some:</i> camera on top of screen, 1.3-megapixel, fixed focus												
Graphics controller Graphics - external	Intel Graphics Media Accelerator 4500MHD (GMA 4500MHD) , in GS45 External monitor support via analog VGA DB-15 connector / DisplayPort via UltraBase; <i>Maximum external resolution:</i> 2048x1536 @75Hz												
Keyboard TrackPoint® Touch pad ThinkLight™	Full-size, 89-key, ThinkVantage button, spill-resistant, mm Fn keys TrackPoint® pointing device, "Press-to-Select," Internet Scroll Bar ¹³ , magnifying glass None None												
Dimensions ³	<i>without X200 UltraBase; 4-cell:</i> 11.6" x 9" x 1-1.3"; 295mm x 228mm x 26.5-33mm <i>without X200 UltraBase; 8-cell:</i> 11.6" x 10.1" x 1-1.3"; 295mm x 257mm x 26.5-33mm												
Weight ² Case Battery - type Battery - life ¹⁰	<i>4-cell:</i> from 3.5 lb (1.6kg); <i>8-cell:</i> from 3.88 lb (1.76kg) <i>Color:</i> black; <i>Material:</i> magnesium alloy Lithium Ion 8-cell <i>4-cell:</i> up to 4.4 hr; <i>8-cell:</i> up to 10.3 hr												
Chipset	Mobile Intel GS45 Express Chipset (Graphics Memory Controller Hub), ICH9M-SFF-Enhanced I/O Controller Hub (SATA 3.0Gb/s, USB 2.0, PCI Express® 1.1, PCI 2.3, security chip, ethernet MAC)												
Media slice Multicard Reader ExpressCard/54 Ports	<i>Optional: X200 UltraBase media slice</i> (see right side) 5-in-1 reader (MultiMediaCard, Memory Stick, Mem Stick Pro, Secure Digital, SDHC) One slot (ExpressCard/34, ExpressCard/54) Three USB 2.0, external monitor (VGA DB-15), modem (RJ-11), ethernet (RJ-45)												
Mini PCI Express Intel 5100 ²⁸ Intel 5300 ²⁸ WWAN upg 2G Turbo UWB Modem Bluetooth™ Ethernet Intel AMT Audio support	Three Mini PCI Express slots <i>Some:</i> 11a/b/g/n wireless ⁴ , Mini PCIe adapter, Intel WiFi Link 5100, 1x2 (Shirley Peak) <i>Some:</i> 11a/b/g/n wireless ⁴ , Mini PCIe adapter, Intel WiFi Link 5300, 3x3 (Shirley Peak) Wireless WAN upgradable, requires Verizon® (43R9151) or AT&T® (43R9152) None None 56K V.92 ⁶ modem <i>Some:</i> Bluetooth 2.0 wireless, LED indicator Intel 82567LM Gigabit Network Connection (Boazman), PHY, PCIe x1 Intel Active Management Technology (IAMT 4.0) High Definition (HD) Audio, AD1984HD codec / stereo speakers, 2 watt / volume up, down, mute buttons / dual array microphone, microphone input jack, headphone jack												
Security Security chip Fingerprint reader	Powered on password, hard disk password, supervisor password, security keyhole Trusted Platform Module, integrated in ICH9M, TCG 1.2-compliant <i>Some:</i> Fingerprint reader on palm rest, swipe sensor, supports the security chip												
Limited warranty ¹²	3-years/1-year battery, limited onsite service²⁴ , 8 am - 5 pm, Mon - Fri coverage excluding holidays, next business day response time / service upgrades ²² available												
2GB PC3-8500 DDR3 SODIMM 128GB SSD SATA 3.0Gb/s 1.8" (2.5" cover) USB 2.0 Super Multi-Burner Drive Other accessories on O-X200 sheet	43R1988 43N3406 41N5565	X200 Tablet Li-Ion Battery 8-cell 90W Slim AC/DC Combo Adapter ThinkPad Ultraportable Case Other accessories at lenovo.com/accessories	43R9257 41N8460 41U5062										

Preloaded operating system²⁰
- *Some:* Microsoft® Windows® XP Tablet PC Edition 2005 with Vista® COA
- *Some:* Microsoft Windows Vista Business Edition (32-bit)
❖ Vista Premium logo

Preloaded applications¹⁴ (all OSes; only some listed)
• Rescue and Recovery™
• Access Connections™
• Client Security Solution™
• ThinkVantage System Update
• McAfee VirusScan® Plus with SiteAdvisor™ (30 days of virus definitions)
• PC-Doctor™ (diagnostics)
• Fingerprint Software (fingerprint models)
• Windows Live™ Toolbar and Search
• Microsoft Office 2007 Trial (60-day)
• Roxio® Creator® Business Edition
• Roxio MyDVD® (DVD±RW)

Supports ThinkVantage® technologies

ThinkPad X200 UltraBase™

- Provides desktop expansion and cable management for X200 Series
- Easily connects to the bottom of the X200 Series for traveling
- Converts ThinkPad to a two-spindle system with optional Ultrabay Slim accessories in right side:
 - CD-RW/DVD-ROM Ultrabay Slim SATA 1.5Gb/s 43N3213
 - DVD Burner Ultrabay Slim SATA 1.5Gb/s 43N3214
 - Blu-ray™ Burner Ultrabay Slim SATA 1.5Gb/s 43N3215
 - Serial Hard Drive Ultrabay Slim Adapter II 43R1980
- Disks supported (some):
 - 200GB FDE 7200 rpm 41N5738
 - 320GB Disk 5400 rpm 43R3403

Other features:

- Power button (front)
- Stereo speakers (2 watt)
- Security key lock, security keyhole, and optional security screw
- Analog DB-15 monitor port
- DisplayPort (supports single-link DVI-D via cable 45J7915)
- Four USB 2.0 ports
- Gigabit ethernet port
- Microphone in and headphone out
- Second battery charger
- Requires 65 or 90 watt AC adapter
- 1.6 lb; 730g

65-watt (GMA graphics) AC Adapter
Climate Savers® certified
ENERGY STAR® 4.0-compliant
EPEAT™ Gold rating (LED models)
EPEAT Silver rating (other models)
ROHS-compliant
International Warranty Service¹⁷
24 hour x 7 day¹⁸ toll-free support during the warranty period¹²
via 800-426-7378

See footnotes for important warranty information
US models announced September 23, 2008

❖ Intel Centrino® 2 with vPro™ technology

ThinkPad® X200 Tablet (7450) - Education (EasyServ)

Personal Systems Reference (PSREF)

Type-model	Proc- essor	GHz	Memory	Widescreen display	Cam	Disk SATA GB ⁸	Optical in rpm	ThinkPad X200 UltraBase	Mini PCIe 802.11 wireless	Mini PCIe WWAN	Mini PCIe UWB or Turbo	Blue/ Fing	Bat- tery cells	Workhorse (W) Global (G) Avail date
7450-2DU	SL9400	1.86	2GB	12.1" WXGA	Cam	160G	5400	Optional	Optional	❖Intel 5100 ²⁸	WWAN upg	None	Yes	8 Bus 32 W Oct 08
<p>• This model has an EasyServ™,19 depot repair service 3-year limited warranty Educational models are available only to public or private K-12 or higher accredited schools organized and operated exclusively for educational purposes for use by qualified students and teachers.</p>														
Positioning Processor	<i>Convertible tablet ultraportable; one spindle</i> Intel® Core™ 2 Duo processor SL9400 with low voltage, dual-core , Intel HD Boost, 1066MHz system bus, and 6MB L2 cache										Preloaded operating system²⁰ - Microsoft® Windows® Vista® Business Edition (32-bit) ❖ Vista Premium logo			
Memory	2GB std / 4GB max ⁷ / PC3-8500 1066MHz DDR3 , non-parity, dual-channel capable, two 204-pin SO-DIMM sockets; <i>Non-italics:</i> standard memory in 1 socket; 1 socket available										Preloaded applications¹⁴ (only some listed)			
Diskette drive SATA DVD±RW Ultrabay Slim SATA disk	None (use optional USB-based diskette drive) None Supports Ultrabay Slim devices in optional or standard <i>X200 UltraBase</i> (43R8781) 160GB⁸ (5400 rpm) / SATA 1.5Gb/s, 9.5mm high, removable, upgradable, ThinkPad Shock Mounted Hard Drive, Active Protection System™, supports 2nd disk in optional or std <i>X200 UltraBase</i>										<ul style="list-style-type: none"> Education software - Microsoft Office OneNote® 2007 (and CD) - VitalSource Library College Edition - Adobe® Instructor Resource Cntr - Adobe Digital School Collection <ul style="list-style-type: none"> - Photoshop Elements (and CD) - Premier Elements (and DVD) - Acrobat 8 Professional - Contribute 4 Access Connections™ ThinkVantage System Update McAfee VirusScan® Plus with SiteAdvisor™ (30 days of virus definitions) 			
Widescreen display	12.1" (308mm) WXGA (1280x800) TFT color , anti-glare, CCFL backlight, 190 nits, 16:10 aspect ratio, 500:1 contrast ratio, FFS, frameless screen, WideView (170° viewing), anti-reflective and anti-glare protective coatings, write on screen with standard digitizer pen , pen holder in front base, rotatable dual swivel hinge for tablet mode (portrait or landscape) or picture frame mode (keyboard faces away from user), buttons on display bottom (power with slide-lock, reset, rotation, menu, all button lock)													
Camera	Camera on top of screen, 1.3-megapixel, fixed focus													
Graphics controller	Intel Graphics Media Accelerator 4500MHD (GMA 4500MHD) , in GS45													
Graphics - external	External monitor support via analog VGA DB-15 connector / DisplayPort via UltraBase; <i>Maximum external resolution: 2048x1536@75Hz</i>										Supports ThinkVantage® technologies			
Keyboard TrackPoint® Touch pad ThinkLight™	Full-size, 89-key, ThinkVantage button, spill-resistant, mm Fn keys TrackPoint® pointing device, "Press-to-Select," Internet Scroll Bar ¹³ , magnifying glass None None										ThinkPad X200 UltraBase™ <ul style="list-style-type: none"> Provides desktop expansion and cable management for X200 Series Easily connects to the bottom of the X200 Series for traveling Converts ThinkPad to a two-spindle system with optional Ultrabay Slim accessories in right side: <ul style="list-style-type: none"> - CD-RW/DVD-ROM Ultrabay Slim SATA 1.5Gb/s 43N3213 - DVD Burner Ultrabay Slim SATA 1.5Gb/s 43N3214 - Blu-ray™ Burner Ultrabay Slim SATA 1.5Gb/s 43N3215 - Serial Hard Drive Ultrabay Slim Adapter II 43R1980 Disks supported (some): <ul style="list-style-type: none"> • 200GB FDE 7200 rpm 41N5738 • 320GB Disk 5400 rpm 43R3403 			
Dimensions ³	<i>without X200 UltraBase; 4-cell:</i> 11.6" x 9" x 1-1.3"; 295mm x 228mm x 26.5-33mm <i>without X200 UltraBase; 8-cell:</i> 11.6" x 10.1" x 1-1.3"; 295mm x 257mm x 26.5-33mm <i>4-cell:</i> from 3.5 lb (1.6kg); <i>8-cell:</i> from 3.88 lb (1.76kg)													
Weight ² Case Battery - type Battery - life ¹⁰	<i>Color:</i> black; <i>Material:</i> magnesium alloy Lithium Ion 8-cell <i>4-cell:</i> up to 4.4 hr; <i>8-cell:</i> up to 10.3 hr													
Chipset	Mobile Intel GS45 Express Chipset (Graphics Memory Controller Hub), ICH9M-SFF-Enhanced I/O Controller Hub (SATA 3.0Gb/s, USB 2.0, PCI Express® 1.1, PCI 2.3, security chip, ethernet MAC)													
Media slice Multicard Reader ExpressCard slot Ports	<i>Optional: X200 UltraBase media slice</i> (see right side) 5-in-1 reader (MultiMediaCard, Memory Stick, Mem Stick Pro, Secure Digital, SDHC) One ExpressCard/34 or ExpressCard/54 Three USB 2.0, external monitor (VGA DB-15), modem (RJ-11), ethernet (RJ-45)													
Mini PCI Express Intel 5100 ²⁸ WWAN upg 2G Turbo UWB Modem Bluetooth™ Ethernet Intel AMT Audio support	Three Mini PCI Express slots 11a/b/g/n wireless ⁴ , Mini PCIe adapter, Intel WiFi Link 5100, 1x2 (Shirley Peak) Wireless WAN upgradable, requires Verizon® (43R9151) or AT&T® (43R9152) None None 56K V.92 ⁶ modem Bluetooth 2.0 wireless, LED indicator Intel 82567LM Gigabit Network Connection (Boazman), PHY, PCIe x1 Intel Active Management Technology (IAMT 4.0) High Definition (HD) Audio, AD1984HD codec / stereo speakers, 2 watt / volume up, down, mute buttons / dual array microphone, microphone input jack, headphone jack										Other features: <ul style="list-style-type: none"> Power button (front) Stereo speakers (2 watt) Security key lock, security keyhole, and optional security screw Analog DB-15 monitor port DisplayPort (supports single-link DVI-D via cable 45J7915) Four USB 2.0 ports Gigabit ethernet port Microphone in and headphone out Second battery charger Requires 65 or 90 watt AC adapter 1.6 lb; 730g 			
Security Security chip Fingerprint reader	Power-on password, hard disk password, supervisor password, security keyhole Trusted Platform Module, integrated in ICH9M, TCG 1.2-compliant Fingerprint reader on palm rest, swipe sensor, supports the security chip													
Limited warranty ¹²	3-years/1-yr battery - EasyServ™,19 depot repair service / service upgrades²² available													
1GB PC3-8500 DDR3 SODIMM	43R1987		X200 Tablet Li-Ion Battery 4-cell		43R9256									
2GB PC3-8500 DDR3 SODIMM	43R1988		X200 Tablet Li-Ion Battery 8-cell		43R9257									
128GB SSD SATA 3.0Gb/s 1.8" (2.5" cover)	43N3406		90W Slim AC/DC Combo Adapter		41N8460									
320GB Disk SATA 1.5Gb/s (5400 rpm)	43N3403		ThinkPad X200 Tablet Sleeve		43R9115									
USB 2.0 Ultra Secure Memory Key 8GB	45J5918		ThinkPad Ultraportable Case		41U5062									
USB 2.0 Portable Secure 320GB Hard Disk	43R2019		ThinkVision® L2240p Wide 22" Monitor		4422HB6									
ThinkPad X200 UltraBase	43R8781		ThinkVision L2440x Wide 24" Monitor		4421HB2									
Other accessories on O-X200 sheet											Other accessories at lenovo.com/accessories			
65-watt (GMA graphics) AC Adapter Climate Savers® certified ENERGY STAR® 4.0-compliant EPEAT Silver rating ROHS-compliant International Warranty Service ¹⁷ 24 hour x 7 day ¹⁸ toll-free support during the warranty period ¹² via 800-426-7378														

See footnotes for important warranty information
 US models announced September 23, 2008

❖ Intel Centrino® 2 with vPro™ technology

© Lenovo
 (CML1-4) September 2008

ThinkPad® X200 Tablet (7453) - Education (Onsite)

Personal Systems Reference (PSREF)

Type-model	Proc- essor	GHz	Memory	Widescreen display	Cam	Disk SATA GB ⁸	Optical in rpm	ThinkPad X200 UltraBase	Mini PCIe 802.11 wireless	Mini PCIe WWAN	Mini PCIe UWB or Turbo	Blue/ Fing	Bat- tery cells	Workhorse (W) Global (G) Avail date
7453-2DU	SL9400	1.86	2GB	12.1" WXGA	Cam	160G	5400	Optional	Optional	❖Intel 5100 ²⁸	WWAN upg	None	Yes	8 Bus 32 W Oct 08
<p>• This model has a limited onsite service²⁴ 3-year limited warranty Educational models are available only to public or private K-12 or higher accredited schools organized and operated exclusively for educational purposes for use by qualified students and teachers.</p>														
Positioning Processor	<i>Convertible tablet ultraportable; one spindle</i> Intel® Core™ 2 Duo processor SL9400 with low voltage, dual-core , Intel HD Boost, 1066MHz system bus, and 6MB L2 cache										Preloaded operating system²⁰ - Microsoft® Windows® Vista® Business Edition (32-bit) ❖ Vista Premium logo			
Memory	2GB std / 4GB max ⁷ / PC3-8500 1066MHz DDR3 , non-parity, dual-channel capable, two 204-pin SO-DIMM sockets; <i>Non-italics:</i> standard memory in 1 socket; 1 socket available										Preloaded applications¹⁴ (only some listed)			
Diskette drive SATA DVD±RW Ultrabay Slim SATA disk	None (use optional USB-based diskette drive) None Supports Ultrabay Slim devices in optional or standard <i>X200 UltraBase</i> (43R8781) 160GB⁸ (5400 rpm) / SATA 1.5Gb/s, 9.5mm high, removable, upgradable, ThinkPad Shock Mounted Hard Drive, Active Protection System™, supports 2nd disk in optional or std <i>X200 UltraBase</i>										<ul style="list-style-type: none"> Education software - Microsoft Office OneNote® 2007 (and CD) - VitalSource Library College Edition - Adobe® Instructor Resource Cntr - Adobe Digital School Collection <ul style="list-style-type: none"> - Photoshop Elements (and CD) - Premier Elements (and DVD) - Acrobat 8 Professional - Contribute 4 Rescue and Recovery™ Access Connections™ McAfee VirusScan® Plus with SiteAdvisor™ (30 days of virus definitions) 			
Widescreen display	12.1" (308mm) WXGA (1280x800) TFT color , anti-glare, CCFL backlight, 190 nits, 16:10 aspect ratio, 500:1 contrast ratio, FFS, frameless screen, WideView (170° viewing), anti-reflective and anti-glare protective coatings, write on screen with standard digitizer pen , pen holder in front base, rotatable dual swivel hinge for tablet mode (portrait or landscape) or picture frame mode (keyboard faces away from user), buttons on display bottom (power with slide-lock, reset, rotation, menu, all button lock)										<ul style="list-style-type: none"> McAfee VirusScan® Plus with SiteAdvisor™ (30 days of virus definitions) 			
Camera	Camera on top of screen, 1.3-megapixel, fixed focus													
Graphics controller	Intel Graphics Media Accelerator 4500MHD (GMA 4500MHD) , in GS45													
Graphics - external	External monitor support via analog VGA DB-15 connector / DisplayPort via UltraBase; <i>Maximum external resolution: 2048x1536@75Hz</i>										Supports ThinkVantage® technologies			
Keyboard TrackPoint® Touch pad ThinkLight™	Full-size, 89-key, ThinkVantage button, spill-resistant, mm Fn keys TrackPoint® pointing device, "Press-to-Select," Internet Scroll Bar ¹³ , magnifying glass None None										ThinkPad X200 UltraBase™ <ul style="list-style-type: none"> Provides desktop expansion and cable management for X200 Series Easily connects to the bottom of the X200 Series for traveling Converts ThinkPad to a two-spindle system with optional Ultrabay Slim accessories in right side: <ul style="list-style-type: none"> - CD-RW/DVD-ROM Ultrabay Slim SATA 1.5Gb/s 43N3213 - DVD Burner Ultrabay Slim SATA 1.5Gb/s 43N3214 - Blu-ray™ Burner Ultrabay Slim SATA 1.5Gb/s 43N3215 - Serial Hard Drive Ultrabay Slim Adapter II 43R1980 Disks supported (some): <ul style="list-style-type: none"> • 200GB FDE 7200 rpm 41N5738 • 320GB Disk 5400 rpm 43R3403 			
Dimensions ³	<i>without X200 UltraBase; 4-cell:</i> 11.6" x 9" x 1-1.3"; 295mm x 228mm x 26.5-33mm <i>without X200 UltraBase; 8-cell:</i> 11.6" x 10.1" x 1-1.3"; 295mm x 257mm x 26.5-33mm <i>4-cell:</i> from 3.5 lb (1.6kg); <i>8-cell:</i> from 3.88 lb (1.76kg)													
Weight ² Case Battery - type Battery - life ¹⁰	<i>Color:</i> black; <i>Material:</i> magnesium alloy Lithium Ion 8-cell <i>4-cell:</i> up to 4.4 hr; <i>8-cell:</i> up to 10.3 hr													
Chipset	Mobile Intel GS45 Express Chipset (Graphics Memory Controller Hub), ICH9M-SFF-Enhanced I/O Controller Hub (SATA 3.0Gb/s, USB 2.0, PCI Express® 1.1, PCI 2.3, security chip, ethernet MAC)													
Media slice Multicard Reader ExpressCard slot Ports	<i>Optional: X200 UltraBase media slice</i> (see right side) 5-in-1 reader (MultiMediaCard, Memory Stick, Mem Stick Pro, Secure Digital, SDHC) One ExpressCard/34 or ExpressCard/54 Three USB 2.0, external monitor (VGA DB-15), modem (RJ-11), ethernet (RJ-45)													
Mini PCI Express Intel 5100 ²⁸ WWAN upg 2G Turbo UWB	Three Mini PCI Express slots 11a/b/g/n wireless ⁴ , Mini PCIe adapter, Intel WiFi Link 5100, 1x2 (Shirley Peak) Wireless WAN upgradable, requires Verizon® (43R9151) or AT&T® (43R9152) None None										Other features: <ul style="list-style-type: none"> Power button (front) Stereo speakers (2 watt) Security key lock, security keyhole, and optional security screw Analog DB-15 monitor port DisplayPort (supports single-link DVI-D via cable 45J7915) Four USB 2.0 ports Gigabit ethernet port Microphone in and headphone out Second battery charger Requires 65 or 90 watt AC adapter 1.6 lb; 730g 			
Modem Bluetooth™ Ethernet Intel AMT Audio support	56K V.92 ⁶ modem Bluetooth 2.0 wireless, LED indicator Intel 82567LM Gigabit Network Connection (Boazman), PHY, PCIe x1 Intel Active Management Technology (IAMT 4.0) High Definition (HD) Audio, AD1984HD codec / stereo speakers, 2 watt / volume up, down, mute buttons / dual array microphone, microphone input jack, headphone jack													
Security Security chip Fingerprint reader	Power-on password, hard disk password, supervisor password, security keyhole Trusted Platform Module, integrated in ICH9M, TCG 1.2-compliant Fingerprint reader on palm rest, swipe sensor, supports the security chip													
Limited warranty ¹²	3-years/1-year battery, limited onsite service²⁴ , 8 am - 5 pm, Mon - Fri coverage excluding holidays, next business day response time / service upgrades ²² available													
2GB PC3-8500 DDR3 SODIMM	43R1988		X200 Tablet Li-Ion Battery 4-cell		43R9256									
128GB SSD SATA 3.0Gb/s 1.8" (2.5" cover)	43N3406		X200 Tablet Li-Ion Battery 8-cell		43R9257									
320GB Disk SATA 1.5Gb/s (5400 rpm)	43N3403		90W Slim AC/DC Combo Adapter		41N8460									
USB 2.0 Ultra Secure Memory Key 8GB	45J5918		ThinkPad X200 Tablet Sleeve		43R9115									
USB 2.0 Portable Secure 320GB Hard Disk	43R2019		ThinkPad Ultraportable Case		41U5062									
ThinkPad X200 UltraBase	43R8781		ThinkVision® L2440x Wide 24" Monitor		4421HB2									
Other accessories on O-X200 sheet			Other accessories at lenovo.com/accessories											

See footnotes for important warranty information
 US models announced September 23, 2008

❖ Intel Centrino® 2 with vPro™ technology

© Lenovo
 (CML1-5) September 2008

Partial list of accessories supported on:

• ThinkPad X200 Tablet originally announced on Sep 23, 2008

Memory

1GB PC3-8500 DDR3 SODIMM (TopSeller)	43R2045	ann 11/04/08
1GB PC3-8500 DDR3 SODIMM	43R1987	ann 08/05/08
2GB PC3-8500 DDR3 SODIMM (TopSeller)	43R2046	ann 11/04/08
2GB PC3-8500 DDR3 SODIMM	43R1988	ann 08/05/08

Ultrabay Slim 9.5mm

Most Ultrabay Slim accessories supported in ThinkPad X200 UltraBase

Storage and removable storage

160GB Disk SATA 1.5Gb/s (5400 rpm) ⁴¹	41N5692	ann 03/20/07
160GB Disk SATA 1.5Gb/s (7200 rpm) ⁴¹	41N5737	ann 10/16/07
200GB Disk FDE SATA 1.5Gb/s (7200 rpm) ⁴¹	41N5738	ann 10/16/07
250GB Disk SATA 1.5Gb/s (5400 rpm) ⁴¹	43R8152	ann 01/15/08
320GB Disk SATA 1.5Gb/s (5400 rpm) ⁴¹	43N3403	ann 08/05/08

⁴¹ Can be used as the main HDD or with Serial ATA Hard Drive Bay Adapter 43R1980 in X200 UltraBase (43R8781)

128GB SSD SATA 3.0Gb/s 1.8" (2.5" cover)	43N3406	ann 08/26/08
USB 2.0 Essential Memory Key 2GB	41U4944	ann 01/23/07
USB 2.0 Essential Memory Key 4GB	45J7904	ann 06/24/08
USB 2.0 Essential Memory Key 8GB	45J7905	ann 07/15/08
USB 2.0 Essential Memory Key 32GB	45K1258	ann 10/28/08
USB 2.0 Security Memory Key 2GB	41U5119	ann 07/17/07
USB 2.0 Security Memory Key 4GB	41U5120	ann 07/17/07
USB 2.0 Ultra Secure Memory Key 1GB	45J5915	ann 08/26/08
USB 2.0 Ultra Secure Memory Key 2GB	45J5916	ann 08/26/08
USB 2.0 Ultra Secure Memory Key 4GB	45J5917	ann 08/26/08
USB 2.0 Ultra Secure Memory Key 8GB	45J5918	ann 08/26/08
USB Portable Diskette Drive	05K9276	ann 06/05/00
USB 2.0 CD-RW/DVD-ROM Combo II Drive	40Y8637	ann 01/05/06
USB 2.0 Portable 160GB Hard Disk	43R1784	ann 09/23/08
USB 2.0 Portable Secure 160GB Hard Disk	43R2018	ann 11/18/08
USB 2.0 Portable Secure 320GB Hard Disk	43R2019	ann 11/18/08
USB 2.0 Super Multi-Burner Drive	41N5565	ann 01/23/07

Wireless WAN (Mini PCI Express)

Verizon WWAN UNDP Broadband Mini PCIe ⁴²	43R9151	ann 08/05/08
AT&T® WWAN HSPA Broadband Mini PCIe ⁴²	43R9152	ann 08/26/08

⁴² Supported only in select models

ThinkPad Expansion

USB 2.0 Lenovo Enhanced Port Replicator	43R8770	ann 02/26/08
ThinkPad Adjustable Notebook Stand	40Y7676	ann 09/20/05
ThinkPad X200 UltraBase	43R8781	ann 08/05/08

Keyboard

TrackPoint Cap Collection	73P2698	ann 12/16/03
USB Numeric Keypad	33L3225	ann 05/01/00
Preferred Pro USB Keyboard	73P5220	ann 06/21/05
Enhanced Performance USB Keyboard	73P2620	ann 03/23/04
Wireless Kybd & Opt Wheel Mouse (via USB)	73P4067	ann 12/07/04
USB Keyboard with UltraNav	31P8950	ann 01/28/03
USB Travel Keyboard with UltraNav	31P9490	ann 04/27/04
Lenovo USB Fingerprint Keyboard	73P4730	ann 02/22/05

Mouse

Optical Wheel Mouse (USB)	06P4069	ann 05/21/03
Optical ScrollPoint® Mouse (USB, PS/2)	31P7405	ann 08/27/02
Optical Wheel Travel Mouse (USB, PS/2)	31P7410	ann 06/04/02
Laser Tilt Wheel Mouse (USB, PS/2)	41U3074	ann 01/23/07
Lenovo Wireless Laser Mouse (blk, via USB)	45K1696	ann 11/25/08
Lenovo Wireless Laser Mouse (red, via USB)	51J0198	ann 11/25/08
Laser Tilt Wheel Travel Mouse (Bluetooth)	41U5008	ann 01/22/08

Security

Kensington® Cable Lock from Lenovo	73P2582	ann 12/29/03
Kensington Twin Head Cable Lock	45K1620	ann 09/30/08
USB Gemplus GemPC Smart Card Reader	41N3040	ann 02/21/06
PC Card Gemplus Smart Card Reader	41N3004	ann 12/13/05
ExpressCard Gemplus Smart Card Reader	41N3043	ann 06/27/06

Multimedia

USB 2.0 Lenovo Multimedia Headset	40Y8518	ann 06/27/06
USB 2.0 Lenovo Webcam	40Y8519	ann 08/29/06

Tablet

ThinkPad Digitizer Pen	41U3143	ann 11/14/06
ThinkPad Tablet Tether (3-pack)	41U4820	ann 11/14/06

Batteries

X200 Tablet Li-Ion Battery 4-cell	43R9256	ann 09/23/08
X200 Tablet Li-Ion Battery 8-cell	43R9257	ann 09/23/08
ThinkPad External Battery Charger ⁴⁴	40Y7625	ann 09/20/05

⁴⁴ Requires the ThinkPad 90W AC Adapter 40Y7659 (adapter provided with some systems).

More information at www.lenovo.com/alldaycomputing

ThinkPad 65W AC Adapter	40Y7696	ann 01/05/06
ThinkPad 90W AC Adapter	40Y7659	ann 09/20/05
ThinkPad 90W Slim AC/DC Combo Adapter	41N8460	ann 11/27/07

More info at www.lenovo.com/support/poweradapters

Charging tips for 90W Slim AC/DC Combo Adapter 41N8460
 • Dual (ThinkPad+Phone) Charging Y-Cable 41R4345 ann 12/18/07
 • BlackBerry charge tip (L8a) 41R4478 ann 12/18/07

More information at www.lenovo.com/support/slimadaptertips

Carrying Cases

X200 Tablet:		
ThinkPad X200 Tablet Sleeve	43R9115	ann 09/23/08
Up to 13.3" widescreen models:		
ThinkPad Ultraportable Case	41U5062	ann 05/13/08
Up to 14.1" widescreen models:		
ThinkPad Expander Case	43R9118	ann 06/24/08
ThinkPad Women's Microfiber Tote	22P8855	
ThinkPad Women's Leather Trim Tote	22P8856	
ThinkPad Convertible Carrying Case	22P8860	
ThinkPad Women's Executive Leather Tote	22P8857	
Women's Executive Red Leather Tote	22P8858	

Up to 15.4" widescreen models:		
Lenovo Carrying Case - Messenger Max	41U5253	ann 05/01/07
Lenovo Carr Case - Performance Backpack	41U5254	ann 05/01/07
Lenovo Standard Case	45K1697	ann 11/25/08
Lenovo Standard Backpack	45K1698	ann 11/25/08
ThinkPad Business Topload Case	43R2476	ann 05/13/08
ThinkPad Business Backpack	43R2482	ann 05/13/08
ThinkPad Deluxe Expander Case	43R2478	ann 05/13/08
ThinkPad Executive Leather Case	43R2480	ann 05/13/08

Up to 17.0" widescreen models:		
ThinkPad 17W Business Topload Case	43R9117	ann 08/12/08

Lenovo luxury cases at www.lenovoluxurycases.com

Monitors

ThinkVision® L174 17" Monitor	9227AE1	ann 04/15/08
ThinkVision L1700p 17" Monitor	9417HE2	ann 09/17/08
ThinkVision L1900p 19" Monitor	4431HE1	ann 11/11/08
ThinkVision L1940p Wide 19" Monitor	4424HB6	ann 09/17/08
ThinkVision L200p Wide 20.1" Monitor	4438HB6	ann 04/15/08
ThinkVision L2240p Wide 22" Monitor	4422HB6	ann 09/17/08
ThinkVision L2440p Wide 24" Monitor	4420HB2	ann 09/17/08
ThinkVision L2440x Wide 24" Monitor	4421HB2	ann 09/17/08

Monitor Accessories⁴⁶

DisplayPort to Single-link DVI-D Cable	45J7915	ann 08/05/08
ThinkVision USB Soundbar	40Y7616	ann 08/23/05
ThinkVision Soundbar	45K1263	ann 09/16/08
Kensington Cable Lock from Lenovo	73P2582	ann 12/29/03
Kensington Twin Head Cable Lock	45K1620	ann 09/30/08
ThinkPad Convertible Monitor Stand	40Y7620	ann 01/05/06
Radial Arm	19K4464	ann 05/05/00

⁴⁶ Compatible on selected Lenovo and ThinkVision monitors.

More information at www.lenovo.com/support/monitoraccessories

Other accessories at www.lenovo.com/accessories

Accessories Guide pdf at www.lenovo.com/accessoriesguide



Lenovo ThinkPad X300, X301



Lenovo ThinkPad X300, X301



Lenovo ThinkPad X300, X301



Lenovo ThinkPad X300, X301



Lenovo ThinkPad X300, X301



Lenovo ThinkPad X300, X301



Lenovo ThinkPad X300, X301
(left side)



Lenovo ThinkPad X300, X301
(rear)

Type-model	Low Voltage processor	GHz	Memory	Wide-screen display	Camera	Disk SATA GB ⁸ SSD	EIDE optical	Mini PCIe 802.11 wireless	Mini PCIe WWAN or Turbo	Mini PCIe UWB wireless	Finger print reader	Battery cells	Preload	Avail date
6478-1HU	SL7100	1.20	2GB	13.3" WXGA+	Cam	64GB SSD	DVD±RW	* Intel 11n ²⁸	WWAN upg		Fing	3	Business 32	Feb 08
6478-1JU	SL7100	1.20	2GB	13.3" WXGA+	Cam	64GB SSD	DVD±RW	* Intel 11n	Verizon+GPS	UWB	Fing	6	Business 32	Feb 08
6478-1TU	SL7100	1.20	2GB	13.3" WXGA+	Cam	64GB SSD	DVD±RW	* Intel 11n	WWAN upg		Fing	3	XP Pro	Feb 08
6478-1VU	SL7100	1.20	2GB	13.3" WXGA+	Cam	64GB SSD	DVD±RW	* Intel 11n	Verizon+GPS		Fing	6	XP Pro	Feb 08

- **These small and medium business (SMB) models are part of the US TopSeller™ Program**
- **Thinnest (starting at under .75") and lightest (starting at 2.93 lb) notebook**
- **Latest connectivity options including WLAN, WWAN, UWB, and GPS**
- **Cutting edge technologies including LED backlight, Solid State Drive, and ultrathin DVD**
- **Environmentally-friendly EPEAT Gold rating**

Positioning Processor	<i>Thinnest and lightest; two spindles</i> Intel® Core™ 2 Duo processor SL7100 with low voltage, dual-core , Intel 64 Technology, Enhanced Intel SpeedStep® technology ¹ , Intel Dynamic Acceleration, Execute Disable Bit, Virtualization Technology, 800MHz system bus, and 4MB shared L2 cache										Preloaded operating system²⁰ - <i>Some:</i> Microsoft® Windows® XP Professional with Vista® COA - <i>Some:</i> Microsoft Windows Vista Business Edition (32-bit) ◇ <i>Vista models:</i> Vista Basic logo			
Memory	2GB std / 4GB max ⁷ / PC2-5300 667MHz DDR2, non-parity, dual-channel capable, two 200-pin SO-DIMM sockets; <i>Non-italics:</i> standard memory in one socket; one socket available										Preloaded applications¹⁴ (all OSes) • Rescue and Recovery™ • Access Connections™ • Client Security Solution™ • ThinkVantage Productivity Center • ThinkVantage System Update • System Migration Assistant • Norton Internet Security (90 days of virus definitions) • Diskeeper™ Home • PC-Doctor™ (diagnostics) • ThinkPad Utilities (Power Manager and Presentation Director) • Adobe® Reader • Windows Live™ Toolbar • Windows Live Search • Picasa from Google • Fingerprint Software (fingerprint models) • Microsoft Office 2007 Trial (60-day) • Sonic RecordNow and Drive Letter Access (DVD±RW) • Corel® WinDVD® (DVD±RW) • Corel WinDVD Creator (XP Pro DVD±RW models)			
Diskette drive	None (use optional USB-based diskette drive)													
EIDE DVD±RW	Ultrathin DVD burner, 7mm high, removable from Option Bay, tray-in													
Option Bay	Modular bay for devices (DVD burner, battery), 7mm high													
Serial ATA disk	64GB⁸ Solid State Drive (SSD) / SATA 3.0Gb/s, 1.8" wide, 8mm high, removable, upgradable, shock mounted storage													
Widescreen display	13.3" (338mm) WXGA+ (1440x900) TFT color , anti-glare, LED backlight , 300 nits, 16:10 aspect ratio, 250:1 contrast ratio													
Camera	Camera on top of screen, 1.3-megapixel, fixed focus, USB 2.0													
Graphics	Intel Graphics Media Accelerator X3100 (GMA X3100) , integrated in GS965, external monitor support via analog VGA DB-15 connector, no DVI-out support													
Keyboard	89-key, ThinkVantage button, spill-resistant, multimedia Fn keys, illuminated buttons (Power, ThinkVantage, Mute, and CapsLk)													
TrackPoint®	TrackPoint® pointing device, "Press-to-Select," Internet Scroll Bar ¹³ , magnifying glass													
Touch pad	UltraNav™, wide touch pad below keyboard, Tap Zones, scrolling regions label													
ThinkLight™	Illuminates the keyboard to improve visibility in low-light conditions													
Dimensions ³	<i>3-cell:</i> (WxDxH): 12.5" x 9.09" x 0.73-0.92"; 318mm x 231mm x 18.6-23.4mm <i>6-cell:</i> (WxDxH): 12.5" x 9.09" x 0.85-0.92"; 318mm x 231mm x 18.6-25.9mm <i>3-cell:</i> from 3.16 lb (1.43kg); <i>6-cell:</i> from 3.35 (1.52kg)													
Weight ²														
Case material	<i>Color:</i> black; <i>Display cover:</i> Carbon-fiber reinforced plastic (top), glass-fiber reinforced plastic (side walls); <i>Base:</i> Magnesium alloy													
Battery - type	Lithium Polymer 3-cell or Lithium Ion 6-cell ; supports optional Option Bay 3-cell battery (for two batteries)													
Battery - life ¹⁰	<i>3-cell:</i> up to 4.3 hr; <i>6-cell:</i> up to 6.5 hr; <i>6-cell and Option Bay battery:</i> up to 10 hr													
Chipset	Mobile Intel GS965 Express Chipset (Graphics Memory Controller Hub); ICH8M-SFF-Enhanced I/O Controller Hub (SATA 3.0Gb/s, ATA-100 EIDE, PCI Express® x1, USB, LPC bus, Bluetooth, fingerprint) / LPC bus (Atmel® 97SC3203 TPM)													
ExpressCard slot	None													
Multicard Reader	None													
Ports	Three USB 2.0, external monitor (VGA DB-15), ethernet (RJ-45)													
Wireless antenna	UltraConnect™ II Antenna / on-off switch for all wireless radios										Supports ThinkVantage® technologies			
Mini PCI Express	Three Mini PCI Express slots / 802.11 and WWAN are customer upgradable													
Intel 11n ²⁸	11a/b/g/n wireless ⁴ , Mini PCIe adapter, Intel Wireless WiFi Link 4965AGN, MIMO 2x3 (Kedron)										65-watt (GMA graphics) AC Adapter Next Generation ThinkPad Roll Cage (in display cover) EPEAT™ Gold rating ENERGY STAR® 4.0-compliant RoHS-compliant International Warranty Service ¹⁷ 24 hour x 7 day ¹⁸ toll-free support during the warranty period ¹² via 800-426-7378			
WWAN upg	<i>Some:</i> Wireless WAN upgradable, requires Verizon® EV-DO Rev. A Mini PCIe (43R1818)													
Verizon+GPS ¹⁶	<i>Some:</i> Wireless WAN with GPS, Sierra Wireless 1xEV-DO Network Adapter, Mini PCIe adapter, EV-DO Rev. A, service contract required with Verizon®										ThinkPlus™.22 2-year LOR ²⁴ 9x5 NBD 41C9175 ThinkPlus 3-year LOR 9x5 NBD 41C9176 ThinkPlus 4-year LOR 9x5 NBD 41C9177 ThinkPlus 5-year LOR 9x5 NBD 41C9179 ThinkPlus 4-year P&L P/U Depot 41C9178 ThinkPlus 5-year P&L P/U Depot 41C9180 Post-warranty annual maintenance agreements at lenovo.com/thinkplus/warranty			
Turbo Memory	None													
UWB	<i>Some:</i> Wireless USB based on Ultra-Wideband (UWB), Half-Mini PCIe adapter													
Modem	None (use optional USB-based modem)													
Bluetooth™	Bluetooth 2.0 wireless, USB 2.0 interface via ICH, LED indicator													
Ethernet	Gigabit ethernet on systemboard, Intel 82566MM Nineveh (PHY), PCIe x1, PXE													
Intel AMT	Intel Active Management Technology (IAMT)													
Audio support	High Definition (HD) Audio, AD1984A codec / stereo speakers, 1 watt / volume up, down, mute buttons / digital microphone, mic input jack, headphone jack													
Security	Power-on password, hard disk password, supervisor password, security keyhole													
Security chip	Trusted Platform Module, Atmel chip, TCG 1.2-compliant													
Fingerprint reader	Fingerprint reader on palm rest, swipe sensor, supports the security chip													
Limited warranty ¹²	3-years/1-yr battery - EasyServ™.19 depot repair service / service upgrades ²² available													
1GB PC2-5300 DDR2 SODIMM (TopSeller)	43R1999			X300 LiPolymer Battery 3-cell			43R1965							
2GB PC2-5300 DDR2 SODIMM (TopSeller)	43R2000			X300 Li-Ion Battery 6-cell			43R1967							
128GB SSD SATA 3.0Gb/s 1.8" (2.5" cover)	43N3406			X300 LiPolymer Bay Battery 3-cell			43R1966							
USB 2.0 Portable Secure 320GB Hard Disk	43R2019			90W Slim AC/DC Combo Adapter			41N8460							
USB 2.0 Super Multi-Burner Drive	41N5565			ThinkPad Executive Leather Case			43R2480							
USB 2.0 Lenovo Enhanced Port Replicator	43R8770			ThinkPad Ultraportable Case			41U5062							
ThinkPad Adjustable Notebook Stand	40Y7676			ThinkVision® L2440p Wide 24" Monitor			4420HB2							
Other accessories on O-X300 sheet				Other accessories at lenovo.com/accessories										

See footnotes for important warranty information
US models announced February 26, 2008

* Intel Centrino with vPro™ technology

Type-model	Low Voltage processor	GHz	Memory	Wide-screen display	Camera	Disk SATA GB ⁸ SSD	EIDE optical	Mini PCIe 802.11 wireless	Mini PCIe WWAN or Turbo	Mini PCIe Finger UWB wireless	Bat- tery reader	Vista preload	Avail date	
6477-1TU	SL7100	1.20	2GB	13.3" WXGA+	Cam	64GB SSD	DVD±RW	* Intel 11n ²⁸	WWAN upg	Finger	6	Business 32	Feb 08	
6477-1UU	SL7100	1.20	4GB	13.3" WXGA+	Cam	64GB SSD	DVD±RW	* Intel 11n	WWAN upg	Finger	6	Ultimate 32	Feb 08	
6477-1ZU	SL7100	1.20	2GB	13.3" WXGA+	Cam	64GB SSD	DVD±RW	* Intel 11n	Verizon+GPS ¹⁶	UWB	Finger	6	Business 32	Feb 08
6477-01U	SL7100	1.20	2GB	13.3" WXGA+	Cam	64GB SSD	DVD±RW	* Intel 11n	AT&T ²³	UWB	Finger	6	Business 32	Apr 08

Italic MTM: not a base model for building a custom model

- **Thinnest (starting at under .75") and lightest (starting at 2.93 lb) notebook**
- **Latest connectivity options including WLAN, WWAN, UWB, and GPS**
- **Cutting edge technologies including LED backlight, Solid State Drive, and ultrathin DVD**
- **Environmentally-friendly EPEAT Gold rating**

Positioning Processor	<i>Thinnest and lightest; two spindles</i> Intel® Core™ 2 Duo processor SL7100 with low voltage, dual-core , Intel 64 Technology, Enhanced Intel SpeedStep® technology ¹ , Intel Dynamic Acceleration, Execute Disable Bit, Virtualization Technology, 800MHz system bus, and 4MB shared L2 cache	Preloaded operating system²⁰ - <i>Some:</i> Microsoft Windows Vista® Business Edition (32-bit) - <i>Some:</i> Microsoft Windows Vista Ultimate Edition (32-bit) ⇨ <i>2GB Vista models:</i> Vista Basic logo ⇨ <i>1UU model:</i> Vista Premium logo Preloaded applications¹⁴ (all OSes) • Rescue and Recovery™ • Access Connections™ • Client Security Solution™ • ThinkVantage Productivity Center • ThinkVantage System Update • System Migration Assistant • Norton Internet Security (90 days of virus definitions) • Diskeeper™ Home • PC-Doctor™ (diagnostics) • ThinkPad Utilities (Power Manager and Presentation Director) • Adobe® Reader • Windows Live™ Toolbar • Windows Live Search • Picasa from Google • Fingerprint Software (fingerprint models) • Microsoft Office 2007 Trial (60-day) • EarthLink Trial (Vista Ultimate model) • Sonic RecordNow and Drive Letter Access (DVD±RW) • Corel® WinDVD® (DVD±RW) • Corel WinDVD Creator (XP Pro DVD±RW models)	
Memory	2GB or 4GB std / 4GB max ⁷ / PC2-5300 667MHz DDR2, non-parity, dual-channel capable, two 200-pin SO-DIMM sockets; <i>Italics:</i> standard memory in both sockets; no sockets available; <i>Non-italics:</i> standard memory in one socket; one socket available		
Diskette drive	None (use optional USB-based diskette drive)		
EIDE DVD±RW	Ultrathin DVD burner, 7mm high, removable from Option Bay, tray-in		
Option Bay	Modular bay for devices (DVD burner, battery), 7mm high		
Serial ATA disk	64GB⁸ Solid State Drive (SSD) / SATA 3.0Gb/s, 1.8" wide, 8mm high, removable, upgradable, shock mounted storage		
Widescreen display	13.3" (338mm) WXGA+ (1440x900) TFT color , anti-glare, LED backlight , 300 nits, 16:10 aspect ratio, 250:1 contrast ratio		
Camera	Camera on top of screen, 1.3-megapixel, fixed focus, USB 2.0		
Graphics	Intel Graphics Media Accelerator X3100 (GMA X3100) , integrated in GS965, external monitor support via analog VGA DB-15 connector, no DVI-out support		
Keyboard	89-key, ThinkVantage button, spill-resistant, multimedia Fn keys, illuminated buttons (Power, ThinkVantage, Mute, and CapsLk)		
TrackPoint®	TrackPoint® pointing device, "Press-to-Select," Internet Scroll Bar ¹³ , magnifying glass		
Touch pad	UltraNav™, wide touch pad below keyboard, Tap Zones, scrolling regions label		
ThinkLight™	Illuminates the keyboard to improve visibility in low-light conditions		
Dimensions ³	<i>3-cell:</i> (WxDxH): 12.5" x 9.09" x 0.73-0.92"; 318mm x 231mm x 18.6-23.4mm <i>6-cell:</i> (WxDxH): 12.5" x 9.09" x 0.85-0.92"; 318mm x 231mm x 18.6-25.9mm		
Weight ²	<i>3-cell:</i> from 3.16 lb (1.43kg); <i>6-cell:</i> from 3.35 (1.52kg)		
Case material	<i>Color:</i> black; <i>Display cover:</i> Carbon-fiber reinforced plastic (top), glass-fiber reinforced plastic (side walls); <i>Base:</i> Magnesium alloy		
Battery - type	Lithium Polymer 3-cell or Lithium Ion 6-cell ; supports optional Option Bay 3-cell battery (for two batteries)		
Battery - life ¹⁰	<i>3-cell:</i> up to 4.3 hr; <i>6-cell:</i> up to 6.5 hr; <i>6-cell and Option Bay battery:</i> up to 10 hr		
Chipset	Mobile Intel GS965 Express Chipset (Graphics Memory Controller Hub); ICH8M-SFF-Enhanced I/O Controller Hub (SATA 3.0Gb/s, ATA-100 EIDE, PCI Express ⁹ x1, USB, LPC bus, Bluetooth, fingerprint) / LPC bus (Atmel® 97SC3203 TPM)		
ExpressCard slot	None		
Multicard Reader	None		
Ports	Three USB 2.0, external monitor (VGA DB-15), ethernet (RJ-45)		
Wireless antenna	UltraConnect™ II Antenna / on-off switch for all wireless radios		
Mini PCI Express	Three Mini PCI Express slots / 802.11 and WWAN are customer upgradable		
Intel 11n ²⁸	11a/b/g/n wireless ⁴ , Mini PCIe adapter, Intel Wireless WiFi Link 4965AGN, MIMO 2x3 (Kedron)		
WWAN upg	<i>Some:</i> Wireless WAN upgradable, requires Verizon® EV-DO Rev. A Mini PCIe (43R1818)		
Verizon+GPS ¹⁶	<i>Some:</i> Wireless WAN with GPS, Sierra Wireless 1xEV-DO Network Adapter, Mini PCIe adapter, EV-DO Rev. A, service contract required with Verizon		
AT&T ²³	<i>Some:</i> Wireless WAN, GPRS/EDGE/UMTS/HSDPA support, Mini PCIe adapter and SIM, service contract required with AT&T®		
Turbo Memory	None		
UWB	<i>Some:</i> Wireless USB based on Ultra-Wideband (UWB), Half-Mini PCIe adapter		
Modem	None (use optional USB-based modem)		
Bluetooth™	Bluetooth 2.0 wireless, USB 2.0 interface via ICH, LED indicator		
Ethernet	Gigabit ethernet on systemboard, Intel 82566MM Nineveh (PHY), PCIe x1, PXE		
Intel AMT	Intel Active Management Technology (IAMT)		
Audio support	High Definition (HD) Audio, AD1984A codec / stereo speakers, 1 watt / volume up, down, mute buttons / digital microphone, mic input jack, headphone jack		
Security	Power-on password, hard disk password, supervisor password, security keyhole		
Security chip	Trusted Platform Module, Atmel chip, TCG 1.2-compliant		
Fingerprint reader	Fingerprint reader on palm rest, swipe sensor, supports the security chip		
Limited warranty ¹²	3-years/1-yr battery - EasyServ™ ¹⁹ depot repair service / service upgrades ²² available		
1GB PC2-5300 DDR2 SODIMM	40Y7734	X300 Li-Ion Battery 6-cell	43R1967
2GB PC2-5300 DDR2 SODIMM	40Y7735	X300 LiPolymer Bay Battery 3-cell	43R1966
128GB SSD SATA 3.0Gb/s 1.8" (2.5" cover)	43N3406	ThinkPad 90W AC Adapter	40Y7659
USB 2.0 Portable Secure 320GB Hard Disk	43R2019	ThinkPad Ultraportable Case	41U5062
USB 2.0 Lenovo Enhanced Port Replicator	43R8770	ThinkVision® L2440x Wide 24" Monitor	4421HB2
Other accessories on O-X300 sheet		Other accessories at lenovo.com/accessories	

See footnotes for important warranty information

* Intel Centrino with vPro™ technology

© Lenovo

Ⓢ US model announced April 14, 2008; previous models on February 26, 2008

(KOD1-2) May 2008

Type-model	Low Voltage proc- essor	GHz	Memory	Wide- screen display	Cam- era	Disk SATA GB ⁸ SSD	EIDE optical	Mini PCIe 802.11 wireless	Mini PCIe WWAN or Turbo	Mini PCIe UWB wireless	Finger print reader	Bat- tery cells	Vista preload	Avail date
4052-1TU	SL7100	1.20	2GB	13.3" WXGA+	Cam	64GB	SSD DVD±RW	*Intel 11n ²⁸	WWAN upg	None	Finger	6	Business 32 P	Apr 08
<ul style="list-style-type: none"> • This model is part of the Global Models Plus program with limited onsite service²⁴ 3-year limited warranty • Thinnest (starting at under .75") and lightest (starting at 2.93 lb) notebook • Latest connectivity options including WLAN, WWAN, UWB, and GPS • Cutting edge technologies including LED backlight, Solid State Drive, and ultrathin DVD • Environmentally-friendly EPEAT Gold rating 														
Positioning Processor	<i>Thinnest and lightest; two spindles</i> Intel® Core™ 2 Duo processor SL7100 with low voltage, dual-core , Intel 64 Technology, Enhanced Intel SpeedStep® technology ¹ , Intel Dynamic Acceleration, Execute Disable Bit, Virtualization Technology, 800MHz system bus, and 4MB shared L2 cache										Preloaded operating system²⁰ - Microsoft® Windows® Vista® Business Edition (32-bit) ⇨ Vista Basic logo			
Memory	2GB std / 4GB max ⁷ / PC2-5300 667MHz DDR2, non-parity, dual-channel capable, two 200-pin SO-DIMM sockets; <i>Non-italics:</i> standard memory in one socket; one socket available										Preloaded applications¹⁴ • Rescue and Recovery™ • Access Connections™ • Client Security Solution™ • ThinkVantage Productivity Center • ThinkVantage System Update • System Migration Assistant • Norton Internet Security (90 days of virus definitions) • Diskeeper™ Home • PC-Doctor™ (diagnostics) • ThinkPad Utilities (Power Manager and Presentation Director) • Adobe® Reader • Windows Live™ Toolbar • Windows Live Search • Picasa from Google • Fingerprint Software (fingerprint models) • Microsoft Office 2007 Trial (60-day) • EarthLink Trial (Vista Ultimate model) • Sonic RecordNow and Drive Letter Access (DVD±RW) • Corel® WinDVD® (DVD±RW)			
Diskette drive	None (use optional USB-based diskette drive)													
EIDE DVD±RW	Ultrathin DVD burner, 7mm high, removable from Option Bay, tray-in													
Option Bay	Modular bay for devices (DVD burner, battery), 7mm high													
Serial ATA disk	64GB⁸ Solid State Drive (SSD) / SATA 3.0Gb/s, 1.8" wide, 8mm high, removable, upgradable, shock mounted storage													
Widescreen display	13.3" (338mm) WXGA+ (1440x900) TFT color , anti-glare, LED backlight , 300 nits, 16:10 aspect ratio, 250:1 contrast ratio													
Camera	Camera on top of screen, 1.3-megapixel, fixed focus, USB 2.0													
Graphics	Intel Graphics Media Accelerator X3100 (GMA X3100) , integrated in GS965, external monitor support via analog VGA DB-15 connector, no DVI-out support													
Keyboard	89-key, ThinkVantage button, spill-resistant, multimedia Fn keys, illuminated buttons (Power, ThinkVantage, Mute, and CapsLk)													
TrackPoint®	TrackPoint® pointing device, "Press-to-Select," Internet Scroll Bar ¹³ , magnifying glass													
Touch pad	UltraNav™, wide touch pad below keyboard, Tap Zones, scrolling regions label													
ThinkLight™	Illuminates the keyboard to improve visibility in low-light conditions													
Dimensions ³	<i>3-cell: (WxDxH): 12.5" x 9.09" x 0.73-0.92"; 318mm x 231mm x 18.6-23.4mm</i> <i>6-cell: (WxDxH): 12.5" x 9.09" x 0.85-0.92"; 318mm x 231mm x 18.6-25.9mm</i>													
Weight ²	<i>3-cell: from 3.16 lb (1.43kg); 6-cell: from 3.35 (1.52kg)</i>													
Case material	<i>Color:</i> black; <i>Display cover:</i> Carbon-fiber reinforced plastic (top), glass-fiber reinforced plastic (side walls); <i>Base:</i> Magnesium alloy													
Battery - type	Lithium Ion 6-cell ;													
Battery - life ¹⁰	supports optional Option Bay 3-cell battery (for two batteries) <i>3-cell:</i> up to 4.3 hr; <i>6-cell:</i> up to 6.5 hr; <i>6-cell and Option Bay battery:</i> up to 10 hr													
Chipset	Mobile Intel GS965 Express Chipset (Graphics Memory Controller Hub); ICH8M-SFF-Enhanced I/O Controller Hub (SATA 3.0Gb/s, ATA-100 EIDE, PCI Express® x1, USB, LPC bus, Bluetooth, fingerprint) / LPC bus (Atmel® 97SC3203 TPM)													
ExpressCard slot	None													
Multicard Reader	None													
Ports	Three USB 2.0, external monitor (VGA DB-15), ethernet (RJ-45)													
Wireless antenna	UltraConnect™ II Antenna / on-off switch for all wireless radios										Supports ThinkVantage® technologies			
Mini PCI Express	Three Mini PCI Express slots / 802.11 and WWAN are customer upgradable													
Intel 11n ²⁸	11a/b/g/n wireless ⁴ , Mini PCIe adapter, Intel Wireless WiFi Link 4965AGN, MIMO 2x3 (Kedron)										65-watt (GMA graphics) AC Adapter Next Generation ThinkPad Roll Cage (in display cover) EPEAT™ Gold rating ENERGY STAR® 4.0-compliant RoHS-compliant International Warranty Service ¹⁷ 24 hour x 7 day ¹⁸ toll-free support during the warranty period ¹² via 800-426-7378			
WWAN upg	Wireless WAN upgradable, requires Verizon® EV-DO Rev. A Mini PCIe (43R1818)													
Turbo Memory	None													
UWB	None													
Modem	None (use optional USB-based modem)													
Bluetooth™	Bluetooth 2.0 wireless, USB 2.0 interface via ICH, LED indicator													
Ethernet	Gigabit ethernet on systemboard, Intel 82566MM Nineveh (PHY), PCIe x1, PXE													
Intel AMT	Intel Active Management Technology (IAMT)													
Audio support	High Definition (HD) Audio, AD1984A codec / stereo speakers, 1 watt / volume up, down, mute buttons / digital microphone, mic input jack, headphone jack													
Security	Power-on password, hard disk password, supervisor password, security keyhole													
Security chip	Trusted Platform Module, Atmel chip, TCG 1.2-compliant													
Fingerprint reader	Fingerprint reader on palm rest, swipe sensor, supports the security chip										ThinkPlus™.22 2-year LOR ²⁴ 9x5 NBD 41C9175			
Limited warranty ¹²	3-years/1-year battery, limited onsite service²⁴ , 8 am - 5 pm, Mon - Fri coverage excluding holidays, next business day response time / service upgrades ²² available										ThinkPlus 3-year LOR 9x5 NBD 41C9176			
1GB PC2-5300 DDR2 SODIMM	40Y7734			X300 LiPolymer Battery 3-cell			43R1965			ThinkPlus 4-year LOR 9x5 NBD 41C9177				
2GB PC2-5300 DDR2 SODIMM	40Y7735			X300 Li-Ion Battery 6-cell			43R1967			ThinkPlus 5-year LOR 9x5 NBD				
128GB SSD SATA 3.0Gb/s 1.8" (2.5" cover)	43N3406			X300 LiPolymer Bay Battery 3-cell			43R1966			41C9179				
USB Portable Diskette Drive	05K9276			ThinkPad 90W AC Adapter			40Y7659			ThinkPlus 4-year P&L P/U Depot 41C9178				
USB 2.0 Lenovo Modem	43R1814			90W Slim AC/DC Combo Adapter			41N8460			41C9178				
USB 2.0 Portable Secure 320GB Hard Disk	43R2019			ThinkPad Executive Leather Case			43R2480			ThinkPlus 5-year P&L P/U Depot 41C9180				
USB 2.0 Super Multi-Burner Drive	41N5565			ThinkPad Ultraportable Case			41U5062							
USB 2.0 Lenovo Enhanced Port Replicator	43R8770			ThinkVision® L2240p Wide 22" Monitor			4422HB6			Post-warranty annual maintenance agreements at				
ThinkPad Adjustable Notebook Stand	40Y7676			ThinkVision L2440x Wide 24" Monitor			4421HB2			lenovo.com/thinkplus/warranty				
Other accessories on O-X300 sheet	Other accessories at lenovo.com/accessories													

See footnotes for important warranty information
US model announced April 8, 2008

* Intel Centrino with vPro™ technology

Type-model	Low Voltage proc- essor	GHz	Memory	Wide- screen display	Cam- era	Disk SATA GB ⁸	EIDE SSD/RPM optical	Mini PCIe 802.11 wireless	Mini PCIe WWAN or Turbo	Mini PCIe UWB or Turbo	Bat- tery Blue/ Fing cells	Intel AMT	Preload	Avail date
2776-TMU	SU9400	1.40	4GB	13.3" WXGA+	Cam	128GB SSD	DVD±RW	Intel 5100 ²⁸	AT&T ²³		Yes	6	Bus 32	Aug 08
2776-L9U	SU9400	1.40	2GB	13.3" WXGA+	Cam	64GB SSD	DVD±RW	Intel 5100	WWAN upg		Yes	3	Bus 32	Aug 08
2776-LAU	SU9400	1.40	2GB	13.3" WXGA+	Cam	64GB SSD	DVD±RW	Intel 5100	AT&T		Yes	6	Bus 32	Aug 08
2776-P4U	SU9400	1.40	2GB	13.3" WXGA+	Cam	64GB SSD	DVD±RW	Intel 5100	WWAN upg		Yes	3	XP Pro	Sep 08
2776-P5U	SU9400	1.40	2GB	13.3" WXGA+	Cam	64GB SSD	DVD±RW	Intel 5100	AT&T		Yes	6	XP Pro	Sep 08
2776-P6U	SU9400	1.40	4GB	13.3" WXGA+	Cam	128GB SSD	DVD±RW	Intel 5100	AT&T		Yes	6	XP Pro	Sep 08
2776-V1U	SU9400	1.40	2GB	13.3" WXGA+	Cam	128GB SSD	DVD±RW	Intel 5300 ²⁸	WWAN upg		Yes	6	Bus 32	Oct 08
2776-V2U	SU9400	1.40	2GB	13.3" WXGA+	Cam	128GB SSD	DVD±RW	Intel 5300	WWAN upg		Yes	6	AMT	Bus 64 Nov 08
2776-TKU	SU9400	1.40	2GB	13.3" WXGA+	Cam	80GB SSD	DVD±RW	Intel 5100	WWAN upg		Yes	3	AMT	Bus 32 Nov 08
2776-TLU	SU9400	1.40	2GB	13.3" WXGA+	Cam	80GB SSD	DVD±RW	Intel 5100	AT&T		Yes	6	AMT	Bus 32 Nov 08
2776-H1U	SU9400	1.40	2GB	13.3" WXGA+	Cam	120GB 5400	DVD±RW	Intel 5100	WWAN upg	2G Turbo	Yes	6	AMT	Bus 32 Dec 08

• These small and medium business (SMB) models are part of the US TopSeller™ Program

Positioning Processor	<i>Thin and light; two spindles</i> Intel® Core™ 2 Duo processor SU9400 with ultra low voltage, dual-core , Intel HD Boost, 800MHz system bus, and 3MB L2 cache	Preloaded operating system²⁰ - <i>Some:</i> Microsoft® Windows® XP Professional with Vista® COA - <i>Some:</i> Microsoft Windows Vista Business Edition (32-bit) - <i>Some:</i> Microsoft Windows Vista Business Edition (64-bit) ⇨ Vista Premium logo Preloaded applications¹⁴ (all OSes) • Rescue and Recovery™ • Access Connections™ • Client Security Solution™ (not on model V2U) • ThinkVantage Productivity Center • ThinkVantage System Update • McAfee VirusScan® Plus with SiteAdvisor™ (30 days of virus definitions) • PC-Doctor™ (diagnostics) • ThinkPad Utilities (Power Manager and Presentation Director) • Adobe® Reader • Windows Live™ Toolbar • Windows Live Search • Windows Live Mail (model V2U) • Windows Live Messenger (model V2U) • Windows Live Photo Gallery (model V2U) • Fingerprint Software (fingerprint models) • Microsoft Office 2007 Trial (60-day) • Roxio® Creator® Business Edition • Roxio MyDVD® (DVD±RW)
Memory	2GB or 4GB std / 4GB max ⁷ / PC3-8500 1066MHz DDR3 , non-parity, dual-channel capable, two 204-pin SO-DIMM sockets; <i>Italics:</i> standard memory in both sockets; no sockets available; <i>Non-italics:</i> standard memory in 1 socket; 1 socket available	
Diskette drive	None (use optional USB-based diskette drive)	
EIDE DVD±RW	Ultrathin DVD burner, 7mm high, removable from Option Bay, tray-in	
Option Bay	Modular bay for devices (DVD burner, battery), 7mm high	
Serial ATA disk	<i>Some:</i> 64GB⁸ 80GB, or 128GB Solid State Drive (SSD) / SATA 3.0Gb/s <i>Some:</i> 120GB⁸ (5400 rpm) / SATA 1.5Gb/s, Active Protection System™ <i>All:</i> 1.8" wide, 8mm high, removable, upgradable, shock mounted storage	
Widescreen display	13.3" (338mm) WXGA+ (1440x900) TFT color , anti-glare, LED backlight , 300 nits, 16:10 aspect ratio, 250:1 contrast ratio	
Camera	Camera on top of screen, 1.3-megapixel, fixed focus, USB 2.0	
Integrated graphics	Intel Graphics Media Accelerator 4500MHD (GMA 4500MHD) , in GS45 External monitor support via analog VGA DB-15 connector or DisplayPort; <i>Maximum external resolution:</i> 2048x1536 @75Hz (VGA, DisplayPort)	
Keyboard	89-key, ThinkVantage button, spill-resistant, multimedia Fn keys, illuminated buttons (Power, ThinkVantage, Mute, and CapsLk)	
TrackPoint®	TrackPoint® pointing device, "Press-to-Select," Internet Scroll Bar ¹³ , magnifying glass	
Touch pad	UltraNav™, wide touch pad below keyboard, Tap Zones, scrolling regions label	
ThinkLight™	Illuminates the keyboard to improve visibility in low-light conditions	
Dimensions ³	<i>3-cell:</i> (WxDxH): 12.5" x 9.09" x 0.73-0.92"; 318mm x 231mm x 18.6-23.4mm <i>6-cell:</i> (WxDxH): 12.5" x 9.09" x 0.85-0.92"; 318mm x 231mm x 18.6-25.9mm <i>3-cell:</i> from 3.16 lb (1.43kg); <i>6-cell:</i> from 3.35 (1.52kg)	
Weight ²		
Case color	Black	
Case material	<i>Display cover:</i> Carbon-fiber reinforced plastic (top), glass-fiber reinforced plastic (side walls); <i>Base:</i> Magnesium alloy	
Battery - type	Lithium Polymer 3-cell or Lithium Ion 6-cell ; supports optional Option Bay 3-cell battery (for two batteries)	
Battery - life ¹⁰	<i>3-cell:</i> up to 3.4 hr; <i>6-cell:</i> up to 5.5 hr; <i>6-cell and Option Bay battery:</i> up to 9.5 hr	
Chipset	Mobile Intel GS45 Express Chipset (Graphics Memory Controller Hub); ICH9M-SFF-Enhanced I/O Controller Hub (SATA 3.0Gb/s, USB 2.0, PCI Express® 1.1, PCI 2.3, security chip, ethernet MAC), Marvell® SATA-to-EIDE bridge (for optical)	
ExpressCard	None	
Multicard reader	None	
Ports	Three USB 2.0, external monitor (VGA DB-15, DisplayPort), ethernet (RJ-45)	
Wireless antenna	UltraConnect™ II Antenna / on-off switch for all wireless radios	
Mini PCI Express	Three Mini PCI Express slots / 802.11 and WWAN are customer upgradable	
Intel 5100 ²⁸	<i>Some:</i> 11a/b/g/n wireless ⁴ , Mini PCIe adapter, Intel WiFi Link 5100, 1x2 (Shirley Peak)	
Intel 5300 ²⁸	<i>Some:</i> 11a/b/g/n wireless ⁴ , Mini PCIe adapter, Intel WiFi Link 5300, 3x3 (Shirley Peak)	
WWAN upg	<i>Some:</i> Wireless WAN upgradable, requires Verizon® (43R9151) or AT&T® (43R9152)	
AT&T ²³	<i>Some:</i> Wireless WAN, Ericsson chipset, Mini PCIe adapter and SIM, GPRS/WCDMA/HSPA, GPS, service contract required with AT&T	
Turbo Memory UWB	<i>Some:</i> Intel Turbo Memory, Half-Mini PCIe adapter, 2GB flash, disk-cache accelerator	
Modem	None (use optional USB-based modem)	
Bluetooth™	Bluetooth 2.0 wireless, USB 2.0 interface via ICH, LED indicator	
Ethernet	Intel 82567LM Gigabit Network Connection (Boazman), PHY, PCIe x1	
Intel AMT	<i>Some:</i> Intel Active Management Technology (IAMT 4.0)	
Audio support	High Definition (HD) Audio, AD1984A codec / stereo speakers, 1 watt / volume up, down, mute buttons / digital microphone, mic input jack, headphone jack	
Security	Power-on password, hard disk password, supervisor password, security keyhole	
Security chip	Trusted Platform Module, integrated in ICH9M, TCG 1.2-compliant	
Fingerprint reader	Fingerprint reader on palm rest, swipe sensor, supports the security chip	
Limited warranty ¹²	3-years/1-yr battery - EasyServ™¹⁹ depot repair service / service upgrades ²² available	
1GB PC3-8500 DDR3 SODIMM (TopSeller) 43R2045	X300 Li-Ion Battery 6-cell	43R1967
2GB PC3-8500 DDR3 SODIMM (TopSeller) 43R2046	90W Slim AC/DC Combo Adapter	41N8460
128GB SSD SATA 3.0Gb/s 1.8" (2.5" cover) 43N3406	ThinkPad Ultraportable Case	41U5062
USB 2.0 Portable Secure 320GB Hard Disk 43R2019	ThinkVision® L2440p Wide 24" Monitor	4420HB2
Other accessories on O-X300 sheet	Other accessories at lenovo.com/accessories	

See footnotes for important warranty information

⇨ Intel Centrino® 2 with vPro™ technology

© Lenovo

Ⓢ US models announced Nov18, Nov 25, or December 2, 2008; previous models on Aug 26, Sep 2, or Oct 14, 2008

(KOD2-1) December 2008

Type-model	Low Voltage processor	GHz	Memory	Wide-screen display	Camera	Disk SATA GB ⁸	SSD	EIDE optical or battery	Mini PCIe 802.11 wireless	Mini PCIe WWAN or Turbo	Mini PCIe UWB wireless	Blue/ Fing	Battery cells	Workhorse (W) Global (G)	Avail date
2774-17U	SU9400	1.40	2GB	13.3" WXGA+	Cam	64GB	SSD	DVD±RW	Intel 5100 ²⁸	WWAN upg	None	Yes	3	Bus 32	G Aug 08
2774-18U	SU9400	1.40	4GB	13.3" WXGA+	Cam	64GB	SSD	DVD±RW	Intel 5100	WWAN upg	None	Yes	6	Bus 32	G Aug 08
2774-LCU	SU9400	1.40	2GB	13.3" WXGA+	Cam	64GB	SSD	Battery	Intel 5100	WWAN upg	None	Yes	6+3	Bus 32	Aug 08
2774-LDU	SU9400	1.40	2GB	13.3" WXGA+	Cam	64GB	SSD	DVD±RW	Intel 5100	WWAN upg	None	Yes	3	XP Pro	Aug 08
2774-PBU	SU9400	1.40	2GB	13.3" WXGA+	Cam	64GB	SSD	Battery	Intel 5100	WWAN upg	None	Yes	6+3	XP Pro	Sep 08
2774-PCU	SU9400	1.40	2GB	13.3" WXGA+	Cam	64GB	SSD	DVD±RW	Intel 5100	WWAN upg	None	Yes	3	XP Pro	Sep 08
2774-21U	SU9400	1.40	2GB	13.3" WXGA+	Cam	80GB	SSD	Battery	Intel 5100	WWAN upg	None	Yes	6	Bus 32	Nov 08
2774-23U	SU9400	1.40	2GB	13.3" WXGA+	Cam	80GB	SSD	DVD±RW	Intel 5100	Verizon ¹⁶	None	Yes	6	Bus 32	Nov 08
2774-HBU	SU9400	1.40	2GB	13.3" WXGA+	Cam	128G	SSD	DVD±RW	WiMAX	WWAN upg	None	Yes	3	Bus 32	Dec 08
2774-HCU	SU9400	1.40	4GB	13.3" WXGA+	Cam	128G	SSD	DVD±RW	WiMAX	WWAN upg	None	Yes	6	Bus 32	Dec 08
2774-HDU	SU9400	1.40	2GB	13.3" WXGA+	Cam	128G	SSD	DVD±RW	Intel 5100	WWAN upg	None	Yes	6	Bus 32	Dec 08

• Latest connectivity options including WLAN, WWAN, UWB, and GPS
 • Cutting edge technologies including LED backlight, Solid State Drive, and ultrathin DVD

Positioning Processor	Thin and light; two spindles Intel® Core™ 2 Duo processor SU9400 with ultra low voltage, dual-core, Intel HD Boost, 800MHz system bus, and 3MB L2 cache	Preloaded operating system²⁰ - Some: Microsoft® Windows® XP Professional with Vista® COA - Some: Microsoft Windows Vista Business Edition (32-bit) ♦ Vista Premium logo Preloaded applications¹⁴ (all OSes) • Rescue and Recovery™ • Access Connections™ • Client Security Solution™ • ThinkVantage Productivity Center • ThinkVantage System Update • McAfee VirusScan® Plus with SiteAdvisor™ (30 days of virus definitions) • PC-Doctor™ (diagnostics) • ThinkPad Utilities (Power Manager and Presentation Director) • Adobe® Reader • Windows Live™ Toolbar • Windows Live Search • Fingerprint Software (fingerprint models) • Microsoft Office 2007 Trial (60-day) • Roxio® Creator® Business Edition • Roxio MyDVD® (DVD±RW)
Memory	2GB or 4GB std / 4GB max ⁷ / PC3-8500 1066MHz DDR3, non-parity, dual-channel capable, two 204-pin SO-DIMM sockets; <i>Italics:</i> standard memory in both sockets; no sockets available; <i>Non-italics:</i> standard memory in 1 socket; 1 socket available	
Diskette drive	None (use optional USB-based diskette drive)	
EIDE DVD±RW	Some: Ultrathin DVD burner, 7mm high, removable from Option Bay, tray-in	
Option Bay battery	Some: 3-cell Li-Polymer second battery in Option Bay	
Option Bay	Modular bay for devices (DVD burner, battery), 7mm high	
Serial ATA disk	64GB ⁸ , 80GB, or 128GB Solid State Drive (SSD) / SATA 3.0Gb/s, 1.8" wide, 8mm high, removable, upgradable, shock mounted storage	
Widescreen display	13.3" (338mm) WXGA+ (1440x900) TFT color, anti-glare, LED backlight, 300 nits, 16:10 aspect ratio, 250:1 contrast ratio	
Camera	Camera on top of screen, 1.3-megapixel, fixed focus, USB 2.0	
Integrated graphics	Intel Graphics Media Accelerator 4500MHD (GMA 4500MHD), in GS45 External monitor support via analog VGA DB-15 connector or DisplayPort; Maximum external resolution: 2048x1536@75Hz	
Keyboard	89-key, ThinkVantage button, spill-resistant, multimedia Fn keys, illuminated buttons (Power, ThinkVantage, Mute, and CapsLk)	
TrackPoint®	TrackPoint® pointing device, "Press-to-Select," Internet Scroll Bar ¹³ , magnifying glass	
Touch pad	UltraNav™, wide touch pad below keyboard, Tap Zones, scrolling regions label	
ThinkLight™	Illuminates the keyboard to improve visibility in low-light conditions	
Dimensions ³	3-cell: (WxDxH): 12.5" x 9.09" x 0.73-0.92"; 318mm x 231mm x 18.6-23.4mm 6-cell: (WxDxH): 12.5" x 9.09" x 0.85-0.92"; 318mm x 231mm x 18.6-25.9mm	
Weight ²	3-cell: from 3.16 lb (1.43kg); 6-cell: from 3.35 (1.52kg)	
Case color	Black	
Case material	Display cover: Carbon-fiber reinforced plastic (top), glass-fiber reinforced plastic (side walls); Base: Magnesium alloy	
Battery - type	Lithium Polymer 3-cell or Lithium Ion 6-cell; supports standard or optional Option Bay 3-cell battery (for two batteries)	
Battery - life ¹⁰	3-cell: up to 3.4 hr; 6-cell: up to 5.5 hr; 6-cell and Option Bay battery: up to 9.5 hr	
Chipset	Mobile Intel GS45 Express Chipset (Graphics Memory Controller Hub); ICH9M-SFF-Enhanced I/O Controller Hub (SATA 3.0Gb/s, USB 2.0, PCI Express® 1.1, PCI 2.3, security chip, ethernet MAC), Marvell® SATA-to-EIDE bridge (for optical)	
ExpressCard	None	
Multicard reader	None	
Ports	Three USB 2.0, external monitor (VGA DB-15, DisplayPort), ethernet (RJ-45)	
Wireless antenna	UltraConnect™ II Antenna / on-off switch for all wireless radios	
Mini PCI Express	Three Mini PCI Express slots / 802.11 and WWAN are customer upgradable	
Intel 5100 ²⁸	11a/b/g/n wireless ⁴ , Mini PCIe adapter, Intel WiFi Link 5100, 1x2 (Shirley Peak)	
WiMAX	Some: 11a/b/g/n and WiMAX wireless ⁴ , Mini PCIe adap, Intel WiMAX/WiFi Link 5350, 3x3 (450Mbps) WiFi + 1x2 WiMAX (Echo Peak)	
WWAN upg	Some: Wireless WAN upgradable, requires Verizon® (43R9151) or AT&T® (43R9152)	
Verizon ¹⁶	Some: Wireless WAN, Qualcomm chipset, Mini PCIe adapter and SIM, EV-DO Rev. A, GPRS/WCDMA/HSPA, GPS, service contract reqd with Verizon	
Turbo Memory	None	
UWB	None	
Modem	None (use optional USB-based modem)	
Bluetooth™	Bluetooth 2.0 wireless, USB 2.0 interface via ICH, LED indicator	
Ethernet	Intel 82567LM Gigabit Network Connection (Boazman), PHY, PCIe x1	
Intel AMT	Intel Active Management Technology (iAMT 4.0)	
Audio support	High Definition (HD) Audio, AD1984A codec / stereo speakers, 1 watt / volume up, down, mute buttons / digital microphone, mic input jack, headphone jack	
Security	Power-on password, hard disk password, supervisor password, security keyhole	
Security chip	Trusted Platform Module, integrated in ICH9M, TCG 1.2-compliant	
Fingerprint reader	Fingerprint reader on palm rest, swipe sensor, supports the security chip	
Limited warranty ¹²	3-years/1-yr battery - EasyServ™.19 depot repair service / service upgrades ²² available	
2GB PC3-8500 DDR3 SODIMM	43R1988	Supports ThinkVantage® technologies 65-watt (GMA graphics) AC Adapter Next Generation ThinkPad Roll Cage (in display cover) EPEAT™ Gold rating ENERGY STAR® 4.0-compliant RoHS-compliant International Warranty Service ¹⁷ 24 hour x 7 day ¹⁸ toll-free support during the warranty period ¹² via 800-426-7378 ThinkPlus™.22 2-year LOR ²⁴ 9x5 NBD 41C9175 ThinkPlus 3-year LOR 9x5 NBD 41C9176 ThinkPlus 4-year LOR 9x5 NBD 41C9177 ThinkPlus 5-year LOR 9x5 NBD 41C9179 ThinkPlus 4-year P&L P/U Depot 41C9178 ThinkPlus 5-year P&L P/U Depot 41C9180 Post-warranty annual maintenance agreements at lenovo.com/thinkplus/warranty
128GB SSD SATA 3.0Gb/s 1.8" (2.5" cover)	43N3406	
Other accessories on O-X300 sheet		
90W Slim AC/DC Combo Adapter	41N8460	
ThinkPad Executive Leather Case	43R2480	
Other accessories at lenovo.com/accessories		

See footnotes for important warranty information

♦ Intel Centrino® 2 with vPro™ technology

Ⓜ US models announced Nov 25 or December 2, 2008; previous models on Aug 26, or Sep 2, 2008

ThinkPad® X301 (4057) - Onsite

Type-model	Low Voltage proc- essor	GHz	Memory	Wide- screen display	Cam- era	Disk SATA GB ⁸ SSD	EIDE optical	Mini PCIe 802.11 wireless	Mini PCIe WWAN or Turbo	Mini PCIe UWB wireless	Blue/ Fing	Bat- tery cells	Workhorse (W) Gbl (G) Avail Preload GMP (P) date
4057-17U	SU9400	1.40	2GB	13.3" WXGA+	Cam	64GB SSD	DVD±RW	❖ Intel 5100 ²⁸	WWAN upg	None	Yes	3	Bus 32 G P Aug 08
4057-18U	SU9400	1.40	4GB	13.3" WXGA+	Cam	64GB SSD	DVD±RW	❖ Intel 5100	WWAN upg	None	Yes	6	Bus 32 G P Aug 08
4057-LDU	SU9400	1.40	2GB	13.3" WXGA+	Cam	64GB SSD	DVD±RW	❖ Intel 5100	WWAN upg	None	Yes	3	XP Pro G P Aug 08

- **These models are part of the Global Models Plus program with limited onsite service²⁴ 3-year limited warranty**
- **Latest connectivity options including WLAN, WWAN, UWB, and GPS**
- **Cutting edge technologies including LED backlight, Solid State Drive, and ultrathin DVD**
- **Environmentally-friendly EPEAT Gold rating**

Positioning Processor	<i>Thin and light; two spindles</i> Intel® Core™ 2 Duo processor SU9400 with ultra low voltage, dual-core , Intel HD Boost, 800MHz system bus, and 3MB L2 cache										Preloaded operating system²⁰ - <i>Some:</i> Microsoft® Windows® XP Professional with Vista® COA - <i>Some:</i> Microsoft Windows Vista Business Edition (32-bit) ❖ Vista Premium logo		
Memory	2GB or 4GB std / 4GB max ⁷ / PC3-8500 1066MHz DDR3 , non-parity, dual-channel capable, two 204-pin SO-DIMM sockets; <i>Italics:</i> standard memory in both sockets; no sockets available;										- <i>Some:</i> Microsoft Windows Vista Business Edition (32-bit) ❖ Vista Premium logo		
Diskette drive EIDE DVD±RW Option Bay Serial ATA disk	None (use optional USB-based diskette drive) Ultrathin DVD burner, 7mm high, removable from Option Bay, tray-in Modular bay for devices (DVD burner, battery), 7mm high 64GB⁸ Solid State Drive (SSD) / SATA 3.0Gb/s, 1.8" wide, 8mm high, removable, upgradable, shock mounted storage										Preloaded applications¹⁴ (all OSes) • Rescue and Recovery™ • Access Connections™ • Client Security Solution™ • ThinkVantage Productivity Center • ThinkVantage System Update • McAfee VirusScan® Plus with SiteAdvisor™ (30 days of virus definitions) • PC-Doctor™ (diagnostics) • ThinkPad Utilities (Power Manager and Presentation Director) • Adobe® Reader • Windows Live™ Toolbar • Windows Live Search • Fingerprint Software (fingerprint models) • Microsoft Office 2007 Trial (60-day) • Roxio® Creator® Business Edition • Roxio MyDVD® (DVD±RW)		
Widescreen display Camera	13.3" (338mm) WXGA+ (1440x900) TFT color , anti-glare, LED backlight , 300 nits, 16:10 aspect ratio, 250:1 contrast ratio Camera on top of screen, 1.3-megapixel, fixed focus, USB 2.0												
Integrated graphics	Intel Graphics Media Accelerator 4500MHD (GMA 4500MHD) , in GS45 External monitor support via analog VGA DB-15 connector or DisplayPort; <i>Maximum external resolution:</i> 2048x1536@75Hz												
Keyboard	89-key, ThinkVantage button, spill-resistant, multimedia Fn keys, illuminated buttons (Power, ThinkVantage, Mute, and CapsLk)												
TrackPoint® Touch pad ThinkLight™	TrackPoint® pointing device, "Press-to-Select," Internet Scroll Bar ¹³ , magnifying glass UltraNav™, wide touch pad below keyboard, Tap Zones, scrolling regions label Illuminates the keyboard to improve visibility in low-light conditions												
Dimensions ³	<i>3-cell:</i> (WxDxH): 12.5" x 9.09" x 0.73-0.92"; 318mm x 231mm x 18.6-23.4mm <i>6-cell:</i> (WxDxH): 12.5" x 9.09" x 0.85-0.92"; 318mm x 231mm x 18.6-25.9mm <i>3-cell:</i> from 3.16 lb (1.43kg); <i>6-cell:</i> from 3.35 (1.52kg)												
Weight ² Case material	<i>Color:</i> black; <i>Display cover:</i> Carbon-fiber reinforced plastic (top), glass-fiber reinforced plastic (side walls); <i>Base:</i> Magnesium alloy												
Battery - type	Lithium Polymer 3-cell or Lithium Ion 6-cell ; supports optional Option Bay 3-cell battery (for two batteries)												
Battery - life ¹⁰	<i>3-cell:</i> up to 3.4 hr; <i>6-cell:</i> up to 5.5 hr; <i>6-cell and Option Bay battery:</i> up to 9.5 hr												
Chipset	Mobile Intel GS45 Express Chipset (Graphics Memory Controller Hub); ICH9M-SFF-Enhanced I/O Controller Hub (SATA 3.0Gb/s, USB 2.0, PCI Express® 1.1, PCI 2.3, security chip, ethernet MAC), Marvell® SATA-to-EIDE bridge (for optical)												
ExpressCard slot Multicard Reader Ports	None None Three USB 2.0, external monitor (VGA DB-15, DisplayPort), ethernet (RJ-45)												
Wireless antenna Mini PCI Express Intel 5100 ²⁸ WWAN upg Turbo Memory UWB Modem Bluetooth™ Ethernet Intel AMT Audio support	UltraConnect™ II Antenna / on-off switch for all wireless radios Three Mini PCI Express slots / 802.11 and WWAN are customer upgradable 11a/b/g/n wireless ⁴ , Mini PCIe adapter, Intel WiFi Link 5100, 1x2 (Shirley Peak) Wireless WAN upgradable, requires Verizon® (43R9151) or AT&T® (43R9152) None None None (use optional USB-based modem) Bluetooth 2.0 wireless, USB 2.0 interface via ICH, LED indicator Intel 82567LM Gigabit Network Connection (Boazman), PHY, PCIe x1 Intel Active Management Technology (IAMT) High Definition (HD) Audio, AD1984A codec / stereo speakers, 1 watt / volume up, down, mute buttons / digital microphone, mic input jack, headphone jack										Supports ThinkVantage® technologies 65-watt (GMA graphics) AC Adapter Next Generation ThinkPad Roll Cage (in display cover) EPEAT™ Gold rating ENERGY STAR® 4.0-compliant RoHS-compliant International Warranty Service ¹⁷ 24 hour x 7 day ¹⁸ toll-free support during the warranty period ¹² via 800-426-7378		
Security Security chip Fingerprint reader	Power-on password, hard disk password, supervisor password, security keyhole Trusted Platform Module, integrated in ICH9M, TCG 1.2-compliant Fingerprint reader on palm rest, swipe sensor, supports the security chip										ThinkPlus™.22 2-year LOR ²⁴ 9x5 NBD 41C9175 ThinkPlus 3-year LOR 9x5 NBD 41C9176 ThinkPlus 4-year LOR 9x5 NBD 41C9177 ThinkPlus 5-year LOR 9x5 NBD 41C9179 ThinkPlus 4-year P&L P/U Depot 41C9178 ThinkPlus 5-year P&L P/U Depot 41C9180 Post-warranty annual maintenance agreements at lenovo.com/thinkplus/warranty		
Limited warranty ¹²	3-years/1-year battery, limited onsite service²⁴ , 8 am - 5 pm, Mon - Fri coverage excluding holidays, next business day response time / service upgrades ²² available												
1GB PC3-8500 DDR3 SODIMM 2GB PC3-8500 DDR3 SODIMM 64GB SSD SATA 3.0Gb/s 1.8" (2.5" cover) 128GB SSD SATA 3.0Gb/s 1.8" (2.5" cover) USB 2.0 Lenovo Modem USB 2.0 Portable Secure 320GB Hard Disk USB 2.0 Super Multi-Burner Drive USB 2.0 Lenovo Enhanced Port Replicator ThinkPad Adjustable Notebook Stand Other accessories on O-X300 sheet	43R1987 43R1988 43N3400 43N3406 43R1814 43R2019 41N5565 43R8770 40Y7676		X300 LiPolymer Battery 3-cell X300 Li-Ion Battery 6-cell X300 LiPolymer Bay Battery 3-cell 90W Slim AC/DC Combo Adapter USB 2.0 Lenovo Multimedia Headset ThinkPad Ultraportable Case ThinkPad Executive Leather Case ThinkVision® L2240p Wide 22" Monitor ThinkVision L2440p Wide 24" Monitor Other accessories at lenovo.com/accessories		43R1965 43R1967 43R1966 41N8460 40Y8518 41U5062 43R2480 4422HB6 4420HB2								

See footnotes for important warranty information
US models announced August 26, 2008

❖ Intel Centrino® 2 with vPro™ technology

© Lenovo
(KOD2-3) September 2008

Partial list of accessories supported on:

- ThinkPad X300 originally announced on February 26, 2008
- ThinkPad X301 originally announced on August 26, 2008

Memory**X300:**

512MB PC2-5300 DDR2 SODIMM	40Y7733	ann	01/05/06
1GB PC2-5300 DDR2 SODIMM (TopSeller)	43R1999	ann	03/25/08
1GB PC2-5300 DDR2 SODIMM	40Y7734	ann	01/05/06
2GB PC2-5300 DDR2 SODIMM (TopSeller)	43R2000	ann	03/25/08
2GB PC2-5300 DDR2 SODIMM	40Y7735	ann	11/28/06

X301:

1GB PC3-8500 DDR3 SODIMM (TopSeller)	43R2045	ann	11/04/08
1GB PC3-8500 DDR3 SODIMM	43R1987	ann	08/05/08
2GB PC3-8500 DDR3 SODIMM (TopSeller)	43R2046	ann	11/04/08
2GB PC3-8500 DDR3 SODIMM	43R1988	ann	08/05/08

Storage and removable storage

128GB SSD SATA 3.0Gb/s 1.8" (2.5" cover)	43N3406	ann	08/26/08
USB 2.0 Essential Memory Key 2GB	41U4944	ann	01/23/07
USB 2.0 Essential Memory Key 4GB	45J7904	ann	06/24/08
USB 2.0 Essential Memory Key 8GB	45J7905	ann	07/15/08
USB 2.0 Essential Memory Key 32GB	45K1258	ann	10/28/08
USB 2.0 Security Memory Key 2GB	41U5119	ann	07/17/07
USB 2.0 Security Memory Key 4GB	41U5120	ann	07/17/07
USB 2.0 Ultra Secure Memory Key 1GB	45J5915	ann	08/26/08
USB 2.0 Ultra Secure Memory Key 2GB	45J5916	ann	08/26/08
USB 2.0 Ultra Secure Memory Key 4GB	45J5917	ann	08/26/08
USB 2.0 Ultra Secure Memory Key 8GB	45J5918	ann	08/26/08
USB Portable Diskette Drive	05K9276	ann	06/05/00
USB 2.0 CD-RW/DVD-ROM Combo II Drive	40Y8637	ann	01/05/06
USB 2.0 Portable 160GB Hard Disk	43R1784	ann	09/23/08
USB 2.0 Portable Secure 160GB Hard Disk	43R2018	ann	11/18/08
USB 2.0 Portable Secure 320GB Hard Disk	43R2019	ann	11/18/08
USB 2.0 Super Multi-Burner Drive	41N5565	ann	01/23/07

Wireless WAN (Mini PCI Express)**X300 WWAN upgradable models:**

Verizon® WWAN EV-DO Rev. A Mini PCIe	43R1818	ann	03/04/08
--------------------------------------	---------	-----	----------

X301 WWAN upgradable models:

Verizon WWAN UNDP Broadband Mini PCIe	43R9151	ann	08/05/08
AT&T® WWAN HSPA Broadband Mini PCIe	43R9152	ann	08/26/08

ThinkPad Expansion

USB 2.0 Lenovo Enhanced Port Replicator	43R8770	ann	02/26/08
ThinkPad Adjustable Notebook Stand	40Y7676	ann	09/20/05

Keyboard

TrackPoint Cap Collection	73P2698	ann	12/16/03
USB Numeric Keypad	33L3225	ann	05/01/00
Preferred Pro USB Keyboard	73P5220	ann	06/21/05
Enhanced Performance USB Keyboard	73P2620	ann	03/23/04
Wireless Kybd & Opt Wheel Mouse (via USB)	73P4067	ann	12/07/04
USB Keyboard with UltraNav	31P8950	ann	01/28/03
USB Travel Keyboard with UltraNav	31P9490	ann	04/27/04
Lenovo USB Fingerprint Keyboard	73P4730	ann	02/22/05
Logitech Bluetooth Cordless Desktop MX5500	45J5831	third-party	

Mouse

Optical Wheel Mouse (USB)	06P4069	ann	05/21/03
Optical ScrollPoint® Mouse (USB, PS/2)	31P7405	ann	08/27/02
Optical Wheel Travel Mouse (USB, PS/2)	31P7410	ann	06/04/02
Laser Tilt Wheel Mouse (USB, PS/2)	41U3074	ann	01/23/07
Lenovo Wireless Laser Mouse (blk, via USB)	45K1696	ann	11/25/08
Lenovo Wireless Laser Mouse (red, via USB)	51J0198	ann	11/25/08
Laser Tilt Wheel Travel Mouse (Bluetooth)	41U5008	ann	01/22/08
Wireless Kybd & Opt Wheel Mouse (via USB)	73P4067	ann	12/07/04
Logitech Bluetooth Cordless Desktop MX5500	45J5831	third-party	

Security

Kensington® Cable Lock from Lenovo	73P2582	ann	12/29/03
Kensington Twin Head Cable Lock	45K1620	ann	09/30/08

Multimedia

USB 2.0 Lenovo Multimedia Headset	40Y8518	ann	06/27/06
USB 2.0 Lenovo Webcam	40Y8519	ann	08/29/06

Modem

USB 2.0 Lenovo Modem	43R1814	ann	02/26/08
----------------------	---------	-----	----------

Batteries

X300 LiPolymer Battery 3-cell	43R1965	ann	02/26/08
X300 Li-Ion Battery 6-cell	43R1967	ann	02/26/08
X300 LiPolymer Bay Battery 3-cell	43R1966	ann	02/26/08

More information at www.lenovo.com/alldaycomputing

ThinkPad 65W AC Adapter	40Y7696	ann	01/05/06
ThinkPad 90W AC Adapter	40Y7659	ann	09/20/05
ThinkPad 90W Slim AC/DC Combo Adapter	41N8460	ann	11/27/07

More info at www.lenovo.com/support/poweradapters

Charging tips for 90W Slim AC/DC Combo Adapter 41N8460

•Dual (ThinkPad+Phone) Charging Y-Cable	41R4345	ann	12/18/07
•Palm device charge tip (L7)	41R4315	ann	12/18/07
•BlackBerry charge tip (L8a)	41R4478	ann	12/18/07
•iPod and iPhone charge tip (L10a)	41R4481	ann	12/18/07

More information at www.lenovo.com/support/slimadapertips

Carrying Cases**Up to 13.3" widescreen models:**

ThinkPad Ultraportable Case	41U5062	ann	05/13/08
-----------------------------	---------	-----	----------

Up to 14.1" widescreen models:

ThinkPad Expander Case	43R9118	ann	06/24/08
ThinkPad Women's Microfiber Tote	22P8855		
ThinkPad Women's Leather Trim Tote	22P8856		
ThinkPad Convertible Carrying Case	22P8860		
ThinkPad Women's Executive Leather Tote	22P8857		
Women's Executive Red Leather Tote	22P8858		

Up to 15.4" widescreen models:

Lenovo Carrying Case - Messenger Max	41U5253	ann	05/01/07
Lenovo Carr Case - Performance Backpack	41U5254	ann	05/01/07
Lenovo Standard Case	45K1697	ann	11/25/08
Lenovo Standard Backpack	45K1698	ann	11/25/08
ThinkPad Business Topload Case	43R2476	ann	05/13/08
ThinkPad Business Backpack	43R2482	ann	05/13/08
ThinkPad Deluxe Expander Case	43R2478	ann	05/13/08
ThinkPad Executive Leather Case	43R2480	ann	05/13/08

Up to 17.0" widescreen models:

ThinkPad 17W Business Topload Case	43R9117	ann	08/12/08
------------------------------------	---------	-----	----------

Lenovo luxury cases at www.lenovoluxurycases.com

Monitors

ThinkVision® L174 17" Monitor	9227AE1	ann	04/15/08
ThinkVision L1700p 17" Monitor	9417HE2	ann	09/17/08
ThinkVision L1900p 19" Monitor	4431HE1	ann	11/11/08
ThinkVision L1940p Wide 19" Monitor	4424HB6	ann	09/17/08
ThinkVision L200p Wide 20.1" Monitor	4438HB6	ann	04/15/08
ThinkVision L2240p Wide 22" Monitor	4422HB6	ann	09/17/08
ThinkVision L2440p Wide 24" Monitor	4420HB2	ann	09/17/08
ThinkVision L2440x Wide 24" Monitor	4421HB2	ann	09/17/08

Monitor Accessories⁴⁶

ThinkVision USB Soundbar	40Y7616	ann	08/23/05
ThinkVision Soundbar	45K1263	ann	09/16/08
Kensington Cable Lock from Lenovo	73P2582	ann	12/29/03
Kensington Twin Head Cable Lock	45K1620	ann	09/30/08
ThinkPad Convertible Monitor Stand	40Y7620	ann	01/05/06
Radial Arm	19K4464	ann	05/05/00

⁴⁶ Compatible on selected Lenovo and ThinkVision monitors.

More information at www.lenovo.com/support/monitoraccessories

Other accessories at www.lenovo.com/accessories

Accessories Guide pdf at www.lenovo.com/accessoriesguide

Partial list of Lenovo® ThinkPlus Services²² for ThinkPad notebooks

For more information see:

http://www.lenovo.com/services_warranty/us/en/index.html

<p>ThinkPlus service upgrade options</p> <p>ThinkPad notebook with 1-year Depot warranty <i>Depot = Depot repair</i></p> <table border="0"> <tr><td>2-year parts and labor depot repair service</td><td>41C9169</td></tr> <tr><td>3-year parts and labor depot repair service</td><td>41C9170</td></tr> <tr><td>4-year parts and labor depot repair service</td><td>41C9172</td></tr> <tr><td>5-year parts and labor depot repair service</td><td>41C9174</td></tr> </table> <p><i>LOR = Lenovo Onsite Repair</i></p> <table border="0"> <tr><td>1-year LOR 9x5 Next Business Day</td><td>41C9166</td></tr> <tr><td>2-year LOR 9x5 Next Business Day</td><td>41C9167</td></tr> <tr><td>3-year LOR 9x5 Next Business Day</td><td>41C9168</td></tr> <tr><td>4-year LOR 9x5 Next Business Day</td><td>41C9171</td></tr> <tr><td>5-year LOR 9x5 Next Business Day</td><td>41C9173</td></tr> </table> <p>ThinkPad notebook with 3-year Depot warranty <i>Depot = Depot repair</i></p> <table border="0"> <tr><td>4-year parts and labor depot repair service</td><td>41C9178</td></tr> <tr><td>5-year parts and labor depot repair service</td><td>41C9180</td></tr> </table> <p><i>LOR = Lenovo Onsite Repair</i></p> <table border="0"> <tr><td>2-year LOR 9x5 Next Business Day</td><td>41C9175</td></tr> <tr><td>3-year LOR 9x5 Next Business Day</td><td>41C9176</td></tr> <tr><td>4-year LOR 9x5 Next Business Day</td><td>41C9177</td></tr> <tr><td>5-year LOR 9x5 Next Business Day</td><td>41C9179</td></tr> </table> <p>ThinkPad notebook with 3-year Onsite warranty <i>LOR = Lenovo Onsite Repair</i></p> <table border="0"> <tr><td>4-year LOR 9x5 Next Business Day</td><td>12X5630</td></tr> <tr><td>5-year LOR 9x5 Next Business Day</td><td>43R2162</td></tr> </table>	2-year parts and labor depot repair service	41C9169	3-year parts and labor depot repair service	41C9170	4-year parts and labor depot repair service	41C9172	5-year parts and labor depot repair service	41C9174	1-year LOR 9x5 Next Business Day	41C9166	2-year LOR 9x5 Next Business Day	41C9167	3-year LOR 9x5 Next Business Day	41C9168	4-year LOR 9x5 Next Business Day	41C9171	5-year LOR 9x5 Next Business Day	41C9173	4-year parts and labor depot repair service	41C9178	5-year parts and labor depot repair service	41C9180	2-year LOR 9x5 Next Business Day	41C9175	3-year LOR 9x5 Next Business Day	41C9176	4-year LOR 9x5 Next Business Day	41C9177	5-year LOR 9x5 Next Business Day	41C9179	4-year LOR 9x5 Next Business Day	12X5630	5-year LOR 9x5 Next Business Day	43R2162	<p>ThinkPlus Priority Support for enterprise customers</p> <ul style="list-style-type: none"> • 9x5 next-business-day response Lenovo Onsite Repair • 24x7 support with priority routing and advanced level technicians <p>ThinkPad notebook with 1-year Depot warranty 3-year Priority Support 45J9094</p> <p>ThinkPad notebook with 3-year Depot warranty</p> <table border="0"> <tr><td>3-year Priority Support</td><td>45J9095</td></tr> <tr><td>4-year Priority Support</td><td>45J9096</td></tr> <tr><td>5-year Priority Support</td><td>45J9097</td></tr> <tr><td>3-year Priority Support 4-hour response</td><td>45J9101</td></tr> <tr><td>4-year Priority Support 4-hour response</td><td>45J9102</td></tr> <tr><td>5-year Priority Support 4-hour response</td><td>45J9103</td></tr> </table> <p>ThinkPad notebook with 3-year Onsite (GMP) warranty</p> <table border="0"> <tr><td>3-year Priority Support</td><td>45J9098</td></tr> <tr><td>4-year Priority Support</td><td>45J9099</td></tr> <tr><td>5-year Priority Support</td><td>45J9100</td></tr> <tr><td>3-year Priority Support 4-hour response</td><td>45J9104</td></tr> <tr><td>4-year Priority Support 4-hour response</td><td>45J9105</td></tr> <tr><td>5-year Priority Support 4-hour response</td><td>45J9106</td></tr> </table> <p>ThinkPad Workstation (W500, W700) notebook with 1-year Depot warranty 3-year Priority Support 45J9107</p> <p>ThinkPad Workstation (W500, W700) notebook with 3-year Depot warranty</p> <table border="0"> <tr><td>3-year Priority Support</td><td>45J9108</td></tr> <tr><td>4-year Priority Support</td><td>45J9109</td></tr> <tr><td>5-year Priority Support</td><td>45J9110</td></tr> <tr><td>3-year Priority Support 4-hour response</td><td>45J9114</td></tr> <tr><td>4-year Priority Support 4-hour response</td><td>45J9115</td></tr> <tr><td>5-year Priority Support 4-hour response</td><td>45J9116</td></tr> </table> <p>ThinkPad Workstation (W500, W700) notebook with 3-year Onsite (GMP) warranty</p> <table border="0"> <tr><td>3-year Priority Support</td><td>45J9111</td></tr> <tr><td>4-year Priority Support</td><td>45J9112</td></tr> <tr><td>5-year Priority Support</td><td>45J9113</td></tr> <tr><td>3-year Priority Support 4-hour response</td><td>45J9117</td></tr> <tr><td>4-year Priority Support 4-hour response</td><td>45K1520</td></tr> <tr><td>5-year Priority Support 4-hour response</td><td>45K1521</td></tr> </table>	3-year Priority Support	45J9095	4-year Priority Support	45J9096	5-year Priority Support	45J9097	3-year Priority Support 4-hour response	45J9101	4-year Priority Support 4-hour response	45J9102	5-year Priority Support 4-hour response	45J9103	3-year Priority Support	45J9098	4-year Priority Support	45J9099	5-year Priority Support	45J9100	3-year Priority Support 4-hour response	45J9104	4-year Priority Support 4-hour response	45J9105	5-year Priority Support 4-hour response	45J9106	3-year Priority Support	45J9108	4-year Priority Support	45J9109	5-year Priority Support	45J9110	3-year Priority Support 4-hour response	45J9114	4-year Priority Support 4-hour response	45J9115	5-year Priority Support 4-hour response	45J9116	3-year Priority Support	45J9111	4-year Priority Support	45J9112	5-year Priority Support	45J9113	3-year Priority Support 4-hour response	45J9117	4-year Priority Support 4-hour response	45K1520	5-year Priority Support 4-hour response	45K1521
2-year parts and labor depot repair service	41C9169																																																																																		
3-year parts and labor depot repair service	41C9170																																																																																		
4-year parts and labor depot repair service	41C9172																																																																																		
5-year parts and labor depot repair service	41C9174																																																																																		
1-year LOR 9x5 Next Business Day	41C9166																																																																																		
2-year LOR 9x5 Next Business Day	41C9167																																																																																		
3-year LOR 9x5 Next Business Day	41C9168																																																																																		
4-year LOR 9x5 Next Business Day	41C9171																																																																																		
5-year LOR 9x5 Next Business Day	41C9173																																																																																		
4-year parts and labor depot repair service	41C9178																																																																																		
5-year parts and labor depot repair service	41C9180																																																																																		
2-year LOR 9x5 Next Business Day	41C9175																																																																																		
3-year LOR 9x5 Next Business Day	41C9176																																																																																		
4-year LOR 9x5 Next Business Day	41C9177																																																																																		
5-year LOR 9x5 Next Business Day	41C9179																																																																																		
4-year LOR 9x5 Next Business Day	12X5630																																																																																		
5-year LOR 9x5 Next Business Day	43R2162																																																																																		
3-year Priority Support	45J9095																																																																																		
4-year Priority Support	45J9096																																																																																		
5-year Priority Support	45J9097																																																																																		
3-year Priority Support 4-hour response	45J9101																																																																																		
4-year Priority Support 4-hour response	45J9102																																																																																		
5-year Priority Support 4-hour response	45J9103																																																																																		
3-year Priority Support	45J9098																																																																																		
4-year Priority Support	45J9099																																																																																		
5-year Priority Support	45J9100																																																																																		
3-year Priority Support 4-hour response	45J9104																																																																																		
4-year Priority Support 4-hour response	45J9105																																																																																		
5-year Priority Support 4-hour response	45J9106																																																																																		
3-year Priority Support	45J9108																																																																																		
4-year Priority Support	45J9109																																																																																		
5-year Priority Support	45J9110																																																																																		
3-year Priority Support 4-hour response	45J9114																																																																																		
4-year Priority Support 4-hour response	45J9115																																																																																		
5-year Priority Support 4-hour response	45J9116																																																																																		
3-year Priority Support	45J9111																																																																																		
4-year Priority Support	45J9112																																																																																		
5-year Priority Support	45J9113																																																																																		
3-year Priority Support 4-hour response	45J9117																																																																																		
4-year Priority Support 4-hour response	45K1520																																																																																		
5-year Priority Support 4-hour response	45K1521																																																																																		
<p>ThinkPlus Secure Business</p> <p>Lenovo Online Data Backup</p> <ul style="list-style-type: none"> • Secure offsite data storage • 256-bit Advanced Encryption System • Data recovery or access in case of an unforeseen event • Automatic, remote management • Choose which business critical data to back up <table border="0"> <tr><td>1-year Lenovo Online Data Backup - 50GB</td><td>45K5849</td></tr> <tr><td>1-year Lenovo Online Data Backup - Unlimited</td><td>45K5870</td></tr> </table> <p>ThinkPad notebook with 1-year Depot warranty <i>Depot = Depot repair</i></p> <table border="0"> <tr><td>1-year Secure Business</td><td>45K2130</td></tr> <tr><td>• 1-year Lenovo Onsite Repair service upgrade</td><td></td></tr> <tr><td>• 1-year ThinkPad Protection</td><td></td></tr> <tr><td>• 1-year 50GB Lenovo Online Data Backup</td><td></td></tr> <tr><td>3-year Secure Business</td><td>45K2131</td></tr> <tr><td>• 3-year Lenovo Onsite Repair service upgrade</td><td></td></tr> <tr><td>• 3-year ThinkPad Protection</td><td></td></tr> <tr><td>• 3-year 50GB Lenovo Online Data Backup</td><td></td></tr> </table> <p>ThinkPad notebook with 3-year Depot warranty <i>Depot = Depot repair</i></p> <table border="0"> <tr><td>3-year Secure Business</td><td>45K5893</td></tr> <tr><td>• 3-year Lenovo Onsite Repair service upgrade</td><td></td></tr> <tr><td>• 3-year ThinkPad Protection</td><td></td></tr> <tr><td>• 3-year 50GB Lenovo Online Data Backup</td><td></td></tr> </table>	1-year Lenovo Online Data Backup - 50GB	45K5849	1-year Lenovo Online Data Backup - Unlimited	45K5870	1-year Secure Business	45K2130	• 1-year Lenovo Onsite Repair service upgrade		• 1-year ThinkPad Protection		• 1-year 50GB Lenovo Online Data Backup		3-year Secure Business	45K2131	• 3-year Lenovo Onsite Repair service upgrade		• 3-year ThinkPad Protection		• 3-year 50GB Lenovo Online Data Backup		3-year Secure Business	45K5893	• 3-year Lenovo Onsite Repair service upgrade		• 3-year ThinkPad Protection		• 3-year 50GB Lenovo Online Data Backup																																																								
1-year Lenovo Online Data Backup - 50GB	45K5849																																																																																		
1-year Lenovo Online Data Backup - Unlimited	45K5870																																																																																		
1-year Secure Business	45K2130																																																																																		
• 1-year Lenovo Onsite Repair service upgrade																																																																																			
• 1-year ThinkPad Protection																																																																																			
• 1-year 50GB Lenovo Online Data Backup																																																																																			
3-year Secure Business	45K2131																																																																																		
• 3-year Lenovo Onsite Repair service upgrade																																																																																			
• 3-year ThinkPad Protection																																																																																			
• 3-year 50GB Lenovo Online Data Backup																																																																																			
3-year Secure Business	45K5893																																																																																		
• 3-year Lenovo Onsite Repair service upgrade																																																																																			
• 3-year ThinkPad Protection																																																																																			
• 3-year 50GB Lenovo Online Data Backup																																																																																			

Availability: All offers subject to availability. Lenovo reserves the right to alter product offerings and specifications at any time, without notice. Lenovo is not responsible for photographic or typographic errors.

Warranty: For a copy of applicable product warranties, write to: Warranty Information, P.O. Box 12195, RTP, NC, 27709, Attn: Dept ZPYA/B676. Lenovo makes no representation or warranty regarding third party products or services.

Footnotes:

- ¹ Power management, including Intel® SpeedStep® Technology, reduces processor speed when in battery mode.
- ² **Weight** includes battery and standard optical drive; weight may vary due to vendor components, manufacturing process and options.
- ³ **Thinness** may vary at certain points on the system.
- ⁴ **Wireless capability:** Requires compatible wireless-enabled options sold separately.
- ⁵ **TAA:** ThinkPad notebook is compliant with the U.S. Federal Government's country-of-origin requirements prescribed in 48 C.F.R. Subpart 25.4; Trade Act Agreement (TAA) model.
- ⁶ **Public network download modem speeds** are limited to 53Kbps. Upload speeds are limited to 48Kbps for V.92 modems. Actual speeds depend on many factors and are often less than the maximum possible. V.92 functions and speeds require compatible phone line and server equipment. Check with your telephone and ISP service providers for availability.
- ⁷ **Maximum memory capacity** may require the replacement of standard component with largest supported component available. On ThinkPad systems, even though it is possible to physically install 4GB of memory, the actual amount of memory addressable by a 32-bit operating system will be limited to 3GB. This limitation does not exist with 64-bit operating systems Windows XP Professional 64-bit and Windows Vista 64-bit Editions.
- ⁸ **Hard drive:** GB = billion bytes, TB = trillion bytes. Accessible capacity is less; up to 4GB is service partition.

⁹ **CD/DVD drive speeds** list maximum rates; rates are variable and are often less than the maximum.

¹⁰ **Battery:** These model numbers achieved the battery life based on MobileMark® 2007 during testing. Battery life (and recharge times) will vary based on many factors including screen brightness, applications, features, power management, battery conditioning, and other customer preferences.

¹² **Limited warranty:** Support unrelated to a warranty issue may be subject to additional charges.

¹³ **Internet access not included.**

¹⁴ **Included software** may differ from its retail version (if available), and may not include user manuals or all program functionality. Software license agreements may apply.

¹⁶ **Activating Verizon Wireless Service:** Lenovo customers will be contacted after purchase to activate service; requires separate agreement with Verizon Wireless and is subject to the Customer Agreement, Calling Plan, and credit approval. Service, airtime, and early termination charges may apply. Verizon Wireless, not Lenovo, is solely responsible for service. Service not available in all areas; purchaser is responsible for verifying that service is available for the intended location before purchasing a computer equipped with WAN card. Network details, coverage limitations, and maps at www.verizonwireless.com.

¹⁷ **International Warranty Service** is available in any country in which this product is sold and serviced. Service delivery methods and parts availability vary by country, may be different from that in the country of purchase, and are subject to change without notice. Fees and restrictions may apply in some countries.

¹⁸ **Telephone support** may be subject to additional charges, even during the limited warranty period. Response times may vary. May exclude some holidays. If a machine is listed as having "On-site service for select repairs", this means that onsite service is available only for the replacement of select parts. For all other warranty repairs, Lenovo will provide the customer a replacement part for customer installation. The parts for which onsite service is available varies by machine, but may include the processor, power supply, heat sink, system board, or base cover. For ThinkPad notebooks with EasyServ or Courier service, Lenovo will attempt to diagnose and resolve the problem remotely before sending a courier.

¹⁹ **EasyServ depot repair service:** In the United States call 1-800-426-7378. The customer may be asked certain diagnostic questions before a courier is sent. Your ThinkPad purchase includes this depot repair service, available in the U.S. during the limited warranty period.

²⁰ **Operating System:** Level of support varies by operating system. Operating systems not preloaded on the system may not provide full feature functionality. Refer to lenovo.com/pc/support and enter your machine type and model number for more information.

²¹ **For combination drives**, maximum possible speeds only are given in the following order: CD write, CD rewrite, CD read, DVD read.

²² **ThinkPlus Services:** These services are available for machines normally used for business, professional, or trade purposes, rather than personal, family, or household purposes. Not all machine types and models are covered. Service period begins with the equipment date of purchase. Service must be purchased during the original limited product warranty period. Service levels are response time objectives and are not guarantees. If the machine problem turns out to be a Customer Replaceable Unit (CRU), a part will be express shipped to you for quick replacement. Onsite 24x7x2-hour service is not available in all locations. For ThinkPad notebooks requiring LCD or other component replacement, Lenovo may choose to perform service at the depot repair center. Calls must be received by 5 pm local time in order to qualify for Next Business Day service. P&L means parts and labor. P/U means pick-up. See ThinkPlus terms and conditions for complete details and restrictions.

²³ **Activating AT&T Wireless Service:** Requires separate agreement with AT&T, subject to service agreement, rate plan and coverage maps. AT&T, not Lenovo, is solely responsible for service. Coverage not available in all areas; AT&T BroadbandConnect available in select metropolitan markets. Special credit and tenure restrictions and additional charges may apply to international roaming. A network connection, third-party software, additional hardware, and/or subscription to a third-party service may be required for certain solutions/applications. Additional restrictions apply, including early termination fee; see www.wireless.att.com for details. To activate call Lenovo Wireless Activation Hot Line at 1-877-299-4710.

²⁴ **Limited onsite service systems** are designed to be repaired during the applicable warranty period primarily with customer-replaceable parts provided by Lenovo. Lenovo will only send a technician onsite to perform a repair if (a) remote telephone diagnosis and/or customer part replacement are unable to resolve the problem, or (b) the part is one of the few designated by Lenovo for onsite replacement. For a list of onsite replaceable parts, contact Lenovo. In the United States call 1-800-426-7378. Support unrelated to a warranty issue may be subject to additional charges. Lenovo onsite repair (LOR), 8 am to 5 pm, Monday through Friday coverage excluding holidays, next business day (NBD) response time.

²⁶ **Full-size keyboard:** As defined by ISO/IEC 15412.

²⁷ **Based on IEEE 802.11a and 802.11b.** A customer can not upgrade to a different wireless Mini PCI adapter due to FCC regulations. Security screws prevent removal of this adapter. This wireless LAN product has been designed to permit legal operation world-wide in regions which it is approved. This product has been tested and certified to be interoperable by the Wireless Ethernet Compatibility Alliance and is authorized to carry the Wi-Fi logo.

²⁸ **The IEEE 802.11n specification (MIMO)** has not been finalized and is currently in draft release. The ThinkPad 11a/b/g/n (11n) Wireless LAN Mini PCI Express Adapters are based on the Draft Release, Version 1.02, of the IEEE 802.11n specification. The Intel Mini PCI Express Adapters are based on the Draft Release, Version 2.0 of the IEEE 802.11n specification. The maximum speed depends on the access point device and the number of integrated antenna used for connection. An adapter with 11a/b, 11a/b/g, or 11a/b/g/n can communicate on any of its supported formats.

³⁰ **Measures only maximum** data transfer rate, not application performance. Many factors affect application performance.

³² **Wireless:** Based on IEEE 802.11a, 802.11b, and 802.11g respectively. An adapter with 11a/b, 11b/g, or 11a/b/g can communicate on either/any of these listed formats respectively, the actual connection will be based on the access point to which it connects.

³⁶ **Wireless upgradable** allows the system to be wireless-enabled with an optional wireless Mini PCI or Mini PCI Express card. Designed to operate only with Lenovo options.

This publication was developed for products and services offered in the United States. Lenovo may not offer the products, services or features discussed in this document in other countries. Lenovo may withdraw an offering at any time. Information is subject to change without notice. Consult your local representative for information on offerings available in your area.

Lenovo reserves the right to change specifications or other product information without notice. Lenovo is not responsible for photographic or typographical errors. LENOVO PROVIDES THIS PUBLICATION "AS IS," WITHOUT WARRANTY OF ANY KIND, EITHER EXPRESS OR IMPLIED, INCLUDING THE IMPLIED WARRANTIES OF MERCHANTABILITY OR FITNESS FOR A PARTICULAR PURPOSE. Some jurisdictions do not allow disclaimer of express or implied warranties in certain transactions, therefore this disclaimer may not apply to you.

The ThinkPad logo consists of the word "ThinkPad" in a bold, black, sans-serif font. A small red dot is positioned above the letter "i". A registered trademark symbol (®) is located to the upper right of the word.

Trademarks: Lenovo, the Lenovo logo, New World. New Thinking., Access Connections, Active Protection System, Rescue and Recovery, ThinkPad, ThinkVantage, ThinkVision, ThinkPlus, ThinkCentre, TrackPoint, UltraConnect, UltraNav, and Ultrabay are trademarks or registered trademarks of Lenovo. The Bluetooth word mark and logos are owned by the Bluetooth SIG, Inc. Any use of such marks by Lenovo is under license. Microsoft, Windows, and Vista are registered trademarks of Microsoft Corporation. Intel, the Intel logo, Intel Inside logo, Intel Core and Core Inside, Intel Centrino logo, Pentium, Celeron and Intel SpeedStep are trademarks or registered trademarks of Intel Corporation or its subsidiaries in the United States and other countries. Cisco and Aironet are registered trademarks of Cisco Corporation. Linux is a trademark of Linus Torvalds in the United States, other countries, or both. Other company, product and service names may be trademarks or service marks of others.

Visit www.lenovo.com/safecomputing periodically for the latest information on safe and effective computing.

Visit www.lenovo.com/psref for the latest version of Personal Systems Reference.

© Lenovo, 2009.
All rights reserved.

Lenovo
1009 Think Place
Morrisville, NC 27560
U.S.A.

January 2009
tabook.pdf



Personal Systems Reference *Lenovo® ThinkPad® SL Notebooks*

January 2009 - Version 350



Lenovo ThinkPad SL500

Visit www.lenovo.com/psref for the latest version

ThinkPad®



Lenovo ThinkPad SL300



Lenovo ThinkPad SL300



Lenovo ThinkPad SL300



Lenovo ThinkPad SL300



Lenovo ThinkPad SL300



Lenovo ThinkPad SL300

Type-model	Processor	GHz	Memory	Wide-screen display	Screen type	Camera	Integrated graphics	Disk SATA GB ⁵ rpm	SATA optical	Mini PCIe 802.11 wireless	Mini PCIe WWAN	Mini PCIe UWB or Turbo	Battery Blue-tooth cells	Preload	Avail date
2738-4BU T5670	1.80	2GB	13.3" WXGA	Glossy	Cam	GMA 250G	5400	DVD±RW	* Intel 5100 ²⁸	AT&T ²³	None	Blue	6	Home P	Aug 08
2738-4CU T5670	1.80	2GB	13.3" WXGA	Glossy		GMA 160G	5400	DVD±RW	* Intel 5100	AT&T	None	Blue	6	Bus 32	Aug 08
2738-4DU T5670	1.80	2GB	13.3" WXGA	Glossy	Cam	GMA 250G	5400	DVD±RW	* Intel 5100	AT&T	None	Blue	6	Bus 32	Aug 08
2738-4EU T5670	1.80	2GB	13.3" WXGA	Glossy	Cam	GMA 250G	5400	DVD±RW	* Intel 5100	WWAN upg	None	Blue	6	Home P	Aug 08
2738-4FU T5670	1.80	2GB	13.3" WXGA	Glossy		GMA 160G	5400	DVD±RW	* Intel 5100	WWAN upg	None	Blue	6	Bus 32	Aug 08
2738-4HU T5670	1.80	2GB	13.3" WXGA	Glossy	Cam	GMA 250G	5400	DVD±RW	* Intel 5100	WWAN upg	None	Blue	6	Bus 32	Aug 08
2738-24U P8600	2.40	2GB	13.3" WXGA	Glossy	Cam	GMA 250G	5400	DVD±RW	† Intel 5100	AT&T	None	Blue	4	Bus 32	Aug 08
2738-25U P8400	2.26	2GB	13.3" WXGA	Glossy		GMA 160G	5400	DVD±RW	† Intel 5100	AT&T	None	Blue	4	Bus 32	Aug 08
2738-43U P8600	2.40	2GB	13.3" WXGA	Glossy	Cam	GMA 250G	5400	DVD±RW	† Intel 5100	AT&T	None	Blue	6	Bus 32	Aug 08
2738-44U P8400	2.26	2GB	13.3" WXGA	Glossy		GMA 160G	5400	DVD±RW	† Intel 5100	AT&T	None	Blue	6	Bus 32	Aug 08
2738-48U P8600	2.40	2GB	13.3" WXGA	Glossy	Cam	GMA 250G	5400	DVD±RW	† Intel 5100	WWAN upg	None	Blue	6	Bus 32	Aug 08
2738-49U P8400	2.26	2GB	13.3" WXGA	Glossy		GMA 160G	5400	DVD±RW	† Intel 5100	WWAN upg	None	Blue	6	Bus 32	Aug 08
2738-72U P8400	2.26	2GB	13.3" WXGA	Glossy		GMA 160G	5400	DVD±RW	† Intel 5100	AT&T	None	Blue	6	XP Pro	Aug 08
2738-73U P8600	2.40	2GB	13.3" WXGA	Glossy	Cam	GMA 250G	5400	DVD±RW	† Intel 5100	WWAN upg	None	Blue	6	XP Pro	Aug 08
2738-74U T5670	1.80	2GB	13.3" WXGA	Glossy		GMA 160G	5400	DVD±RW	* Intel 5100	WWAN upg	None	Blue	6	XP Pro	Aug 08
2738-75U T5670	1.80	2GB	13.3" WXGA	Glossy	Cam	GMA 250G	5400	DVD±RW	* Intel 5100	WWAN upg	None	Blue	6	XP Pro	Aug 08
2738-7EU P8400	2.26	2GB	13.3" WXGA	Glossy		GMA 160G	5400	DVD±RW	† Intel 5100	WWAN upg	None	Blue	6	XP Pro	Aug 08
2738-8ZU P7370	2.00	2GB	13.3" WXGA	Glossy		GMA 250G	5400	DVD±RW	† Intel 5100	WWAN upg	None	Blue	6	XP Pro	Sep 08
2738-2ZU T5870	2.00	2GB	13.3" WXGA	Glossy	Cam	GMA 250G	5400	DVD±RW	* Intel 5100	WWAN upg	None	Blue	6	XP Pro	Oct 08

• These small and medium business (SMB) models are part of the US TopSeller™ Program

Processor	Intel® Core™ 2 Duo processor T5670 or T5870 with dual-core, 800MHz system bus, and 2MB L2 cache or Intel Core 2 Duo processor P7370, P8400, or P8600 with dual-core, Intel HD boost, 1066MHz system bus, and 3MB L2 cache	Preloaded operating system ²⁰ - Some: Microsoft® Windows® XP Professional with Vista® COA
Memory	2GB std / 4GB max ⁷ / PC2-5300 667MHz DDR2, non-parity, dual-channel capable, two 200-pin SO-DIMM sockets; <i>Italics:</i> standard memory in both sockets; no sockets available; <i>Non-italics:</i> standard memory in one socket; one socket available	- Some: Microsoft Windows Vista Business Edition (32-bit) - Some: Microsoft Windows Vista Home Premium (32-bit) ♦ XP Pro models: Vista Basic logo ♦ Vista models: Vista Premium logo
SATA DVD±RW SATA disk	Some: DVD burner, SATA 1.5Gb/s, 12.7mm high, fixed, not removable, tray-in 160GB ⁸ (5400 rpm) or 250GB (5400 rpm) / SATA 1.5Gb/s, 9.5mm high, removable, upgradable, ThinkPad Shock Mounted Hard Drive, Active Protection System™	Preloaded applications ¹⁴ (all OSes) • Lenovo Care™ Tools • Rescue and Recovery™ • Access Connections™ • Password Manager • System Update • McAfee VirusScan® Plus with SiteAdvisor™ (30 days of virus definitions) • PC-Doctor™ (diagnostics) • ThinkPad Utilities (Power Manager and Presentation Director) • Adobe® Reader • Windows Live™ Toolbar and Search • Fingerprint Software • Microsoft Office 2007 Trial (60-day) • Roxio® Creator® Small Business Edition • Roxio MyDVD® (DVD±RW)
Widescreen display Camera	13.3" (338mm) WXGA (1280x800) color, VibrantView (glossy), LED backlight, 300 nits, 16:10 aspect ratio, 300:1 contrast ratio Some: camera on top of screen, 1.3-megapixel, fixed focus	
Integrated graphics	Intel Graphics Media Accelerator 4500MHD (GMA 4500MHD), in GM45, HDMI port supporting HDCP to output protected content; Max external resolution: 2048x1536@75Hz (VGA DB-15); 1920x1080 (HDMI)	
Keyboard TrackPoint® Touch pad Lighting FX	89-key, Lenovo Care button, spill-resistant, multimedia Fn keys TrackPoint® pointing device, Internet Scroll Bar ¹³ , magnifying glass UltraNav™, wide touch pad below keyboard, Tap Zones, scrolling regions label Illuminated power button, Lenovo Care button, and red dot on ThinkPad logo	
Dimensions ³ Weight ²	6-cell (WxDxH): 12.5" x 9.4" x 1.18–1.33"; 318mm x 238mm x 30–34mm 4-cell: starting at 4.57 lb (2.07kg) 6-cell: starting at 4.76 lb (2.16kg)	
Case color Case material Battery - type Battery - life ¹⁰	Black Scratch-resistant ABS plastic, high-gloss top cover Lithium Ion 4-cell or 6-cell 4-cell: up to 3.0 hr; 6-cell: up to 4.5 hr	
Chipset	Mobile Intel GM45 Express Chipset (Graphics Memory Controller Hub), ICH9M I/O Controller Hub (SATA 3.0Gb/s, USB 2.0, PCI Express® 1.1, PCI 2.3, security chip, ethernet MAC), LPC bus (IT8752 Super I/O)	
ExpressCard/54 Multicard reader PC Card Smart Card read Ports	One slot (ExpressCard/34, ExpressCard/54) 7-in-1 reader (MMC, Memory Stick, Mem Stick PRO™, SD, SDHC, XD, XD Type H) None None Three USB 2.0, external monitor (VGA DB-15, HDMI), modem (RJ-11), ethernet (RJ-45), IEEE 1394 FireWire 400 (4-pin connector; 1394a-2000 standard)	65-watt (GMA graphics) AC adapter EPEAT™ Gold rating ENERGY STAR® 4.0-compliant RoHS-compliant International Warranty Service ¹⁷ 24 hour x 7 day ¹⁸ toll-free support during the warranty period ¹² via 800-426-7378
Mini PCI Express Intel 5100 ²⁸ WWAN upg AT&T ²³	Three Mini PCI Express slots 11a/b/g/n wireless ⁴ , Mini PCIe adapter, Intel WiFi Link 5100, 1x2 (Shirley Peak) Some: Wireless WAN upgradable, optional AT&T® (43R9152) Some: Wireless WAN, Ericsson chipset, Mini PCIe adapter and SIM, GPRS/WCDMA/HSPA, GPS, service contract required with AT&T®	ThinkPlus™, 22 1-year LOR ²⁴ 9x5 NBD 41C9166 ThinkPlus 2-year LOR 9x5 NBD 41C9167 ThinkPlus 3-year LOR 9x5 NBD 41C9168 ThinkPlus 4-year LOR 9x5 NBD 41C9171 ThinkPlus 2-year P&L P/U Depot 41C9169 ThinkPlus 3-year P&L P/U Depot 41C9170 ThinkPlus 4-year P&L P/U Depot 41C9172
2G Turbo UWB Modem Bluetooth™ Ethernet Intel AMT Audio support	None None 56K V.92 ⁶ modem Bluetooth 2.0 wireless, LED indicator Realtek RTL8111C Gigabit Network Connection, PHY, PCIe x1 None High Definition (HD) Audio, CX20561-15Z codec / stereo speakers, 1.5 watt / volume up, down, mute buttons / dual array microphone, mic input jack, headphone jack	
Security Security chip Fingerprint reader	Power-on password, hard disk password, supervisor password, security keyhole None Fingerprint reader on palm rest, swipe sensor, supports the security chip	Post-warranty annual maintenance agreements at lenovo.com/thinkplus/warranty
Limited warranty ¹²	1-year - EasyServ™, 19 depot repair service / service upgrades ²² available	

See footnotes for important warranty information

* Intel Centrino® processor technology

© Lenovo

US model announced October 14, 2008;

† Intel Centrino 2 processor technology

(CAR1-1) December 2008

previous models on August 12, August 19, or September 30, 2008

⚠ US models withdrawn effective September 2008 or January 2009

ThinkPad® SL300 2738 (GMA) - TopSeller (January 2009)

Personal Systems Reference (PSREF)

Type-model	Proc- essor GHz	Memory	Wide- screen display	Screen type	Cam- era	Integrated graphics	Disk SATA GB ⁸ rpm	SATA optical	Mini PCIe 802.11 wireless	Mini PCIe WWAN	Mini PCIe UWB or Turbo	Blue- tooth	Finger print reader	Bat- tery cells	Preload	Avail date	
2738-A2U	T5870	2.00 2GB	13.3"	WXGA	Glossy	GMA	160G 5400	DVD±RW	* Intel 5100 ²⁸	WWAN upg	None	Blue	Fing	6	XP Pro	Dec 08	
2738-A3U	T5870	2.00 2GB	13.3"	WXGA	Glossy	GMA	160G 5400	DVD±RW	* Intel 5100	WWAN upg	None	Blue	Fing	6	Bus 32	Dec 08	
2738-A4U	T5870	2.00 3GB	13.3"	WXGA	Glossy	Cam	GMA	250G 5400	DVD±RW	* Intel 5100	WWAN upg	None	Blue	Fing	6	Home P	Dec 08
2738-2JU	P8600	2.40 2GB	13.3"	WXGA	Glossy	Cam	GMA	250G 5400	DVD±RW	* Intel 5100	WWAN upg	None	Fing	4	Bus 32	Dec 08	
2738-H2U	P8600	2.40 2GB	13.3"	WXGA	Glossy	GMA	160G 5400	DVD±RW	* WiMAX	WWAN upg	None	Blue	Fing	6	Bus 32	Jan 09	

• These small and medium business (SMB) models are part of the US TopSeller™ Program

Processor	Intel® Core™ 2 Duo processor T5870 with dual-core, 800MHz system bus, and 2MB L2 cache or Intel Core 2 Duo processor P8600 with dual-core, Intel HD boost, 1066MHz system bus, and 3MB L2 cache										Preloaded operating system²⁰ - <i>Some:</i> Microsoft® Windows® XP Professional with Vista® COA					
Memory	2GB or 3GB std / 4GB max ⁷ / PC2-5300 667MHz DDR2, non-parity, dual-channel capable, two 200-pin SO-DIMM sockets; <i>Italics:</i> standard memory in both sockets; no sockets available; <i>Non-italics:</i> standard memory in one socket; one socket available										- <i>Some:</i> Microsoft Windows Vista Business Edition (32-bit) - <i>Some:</i> Microsoft Windows Vista Home Premium (32-bit) ◇ <i>2JU model:</i> Vista Premium logo ◇ <i>Other models:</i> Vista Basic logo					
SATA DVD±RW SATA disk	<i>Some:</i> DVD burner, SATA 1.5Gb/s, 12.7mm high, fixed, not removable, tray-in 160GB⁸ (5400 rpm) or 250GB (5400 rpm) / SATA 1.5Gb/s, 9.5mm high, removable, upgradable, ThinkPad Shock Mounted Hard Drive, Active Protection System™										Preloaded applications¹⁴ (all OSes) • Lenovo Care™ Tools • Rescue and Recovery™ • Access Connections™ • Password Manager • System Update • McAfee VirusScan® Plus with SiteAdvisor™ (30 days of virus definitions) • PC-Doctor™ (diagnostics) • ThinkPad Utilities (Power Manager and Presentation Director) • Adobe® Reader • Windows Live™ Toolbar • Windows Live Search • Windows Live Mail (model 2JU) • Windows Live Messenger (model 2JU) • Windows Live Photo Gallery (model 2JU) • Fingerprint Software • Microsoft Office 2007 Trial (60-day) • Roxio® Creator® Small Business Edition • Roxio MyDVD® (DVD±RW)					
Widescreen display Camera	13.3" (338mm) WXGA (1280x800) color, VibrantView (glossy) , LED backlight, 300 nits, 16:10 aspect ratio, 300:1 contrast ratio <i>Some:</i> camera on top of screen, 1.3-megapixel, fixed focus															
Integrated graphics	Intel Graphics Media Accelerator 4500MHD (GMA 4500MHD) , in GM45, HDMI port supporting HDCP to output protected content; <i>Max external resolution:</i> 2048x1536@75Hz (VGA DB-15); 1920x1080 (HDMI)															
Keyboard TrackPoint® Touch pad Lighting FX	89-key, Lenovo Care button, spill-resistant, multimedia Fn keys TrackPoint® pointing device, Internet Scroll Bar ¹³ , magnifying glass UltraNav™, wide touch pad below keyboard, Tap Zones, scrolling regions label Illuminated power button, Lenovo Care button, and red dot on ThinkPad logo															
Dimensions ³ Weight ²	<i>6-cell (WxDxH):</i> 12.5" x 9.4" x 1.18–1.33"; 318mm x 238mm x 30–34mm <i>4-cell:</i> starting at 4.57 lb (2.07kg) <i>6-cell:</i> starting at 4.76 lb (2.16kg)															
Case color Case material Battery - type Battery - life ¹⁰	Black Scratch-resistant ABS plastic, high-gloss top cover Lithium Ion 4-cell or 6-cell <i>4-cell:</i> up to 3.0 hr; <i>6-cell:</i> up to 4.5 hr															
Chipset	Mobile Intel GM45 Express Chipset (Graphics Memory Controller Hub), ICH9M I/O Controller Hub (SATA 3.0Gb/s, USB 2.0, PCI Express® 1.1, PCI 2.3, security chip, ethernet MAC), LPC bus (IT8752 Super I/O)															
ExpressCard/54 Multicard reader PC Card Smart Card read Ports	One slot (ExpressCard/34, ExpressCard/54) 7-in-1 reader (MMC, Memory Stick, Mem Stick PRO™, SD, SDHC, XD, XD Type H) None None Three USB 2.0, external monitor (VGA DB-15, HDMI), modem (RJ-11), ethernet (RJ-45), IEEE 1394 FireWire 400 (4-pin connector; 1394a-2000 standard)										Supports ThinkVantage® technologies					
Mini PCI Express Intel 5100 ²⁸ WiMAX WWAN upg 2G Turbo UWB Modem Bluetooth™ Ethernet Intel AMT Audio support Security Security chip Fingerprint reader	Three Mini PCI Express slots <i>Some:</i> 11a/b/g/n wireless ⁴ , Mini PCIe adapter, Intel WiFi Link 5100, 1x2 (Shirley Peak) <i>Some:</i> 11a/b/g/n and WiMAX wireless ⁴ , Mini PCIe adap, Intel WiMAX/WiFi Link 5150, 1x2 (300Mbps) WiFi + 1x2 WiMAX (Echo Peak) Wireless WAN upgradable, optional AT&T® (43R9152) None None 56K V.92 ⁶ modem <i>Some:</i> Bluetooth 2.0 wireless, LED indicator Realtek RTL8111C Gigabit Network Connection, PHY, PCIe x1 None High Definition (HD) Audio, CX20561-15Z codec / stereo speakers, 1.5 watt / volume up, down, mute buttons / dual array microphone, mic input jack, headphone jack Power-on password, hard disk password, supervisor password, security keyhole None <i>Some:</i> Fingerprint reader on palm rest, swipe sensor, supports the security chip										65-watt (GMA graphics) AC adapter EPEAT™ Gold rating ENERGY STAR® 4.0-compliant RoHS-compliant International Warranty Service ¹⁷ 24 hour x 7 day ¹⁸ toll-free support during the warranty period ¹² via 800-426-7378					
Limited warranty ¹²	1-year - EasyServ™ ¹⁹ depot repair service / service upgrades ²² available										ThinkPlus™ ²² 1-year LOR ²⁴ 9x5 NBD 41C9166 ThinkPlus 2-year LOR 9x5 NBD 41C9167 ThinkPlus 3-year LOR 9x5 NBD 41C9168 ThinkPlus 4-year LOR 9x5 NBD 41C9171 ThinkPlus 2-year P&L P/U Depot 41C9169 ThinkPlus 3-year P&L P/U Depot 41C9170 ThinkPlus 4-year P&L P/U Depot 41C9172 Post-warranty annual maintenance agreements at lenovo.com/thinkplus/warranty					
1GB PC2-5300 DDR2 SODIMM (TopSeller)	43R1999			SL300 Series Li-Ion Battery 4-cell			43R9252									
2GB PC2-5300 DDR2 SODIMM (TopSeller)	43R2000			T/R/W/SL Series Li-Ion Battery 6-cell			40Y6799									
SL 320GB Disk SATA 1.5Gb/s (5400 rpm)	43N3405			T/R/W/SL Series Li-Ion Battery 9-cell			40Y6797									
USB 2.0 Ultra Secure Memory Key 8GB	45J5918			ThinkPad Basic Case			43R9113									
USB 2.0 Lenovo Enhanced Port Replicator	43R8770			ThinkPad Business Backpack			43R2482									
Laser Tilt Wheel Travel Mouse (Bluetooth)	41U5008			ThinkVision® L2240p Wide 22" Monitor			4422HB6									
AT&T HSPA WWAN (Ericsson) Mini PCIe	43R9152			ThinkVision L2440p Wide 24" Monitor			4420HB2									
Other accessories on O-SL300 sheet				Other accessories at lenovo.com/accessories												

See footnotes for important warranty information
US models announced Dec 16, 2008 or Jan 6, 2009

* Intel Centrino® processor technology
✦ Intel Centrino 2 processor technology

© Lenovo
(CAR11-1) January 2009

ThinkPad® SL300 2738 (NVIDIA®) - TopSeller

Personal Systems Reference (PSREF)

Proc- Type-model	Processor GHz	Memory	Wide- screen display	Screen type	Cam- era	Discrete graphics	Disk SATA GB ⁵ rpm	SATA optical	Mini PCIe 802.11 wireless	Mini PCIe WWAN	Mini PCIe UWB or Turbo	Bat- tery Blue- tooth cells	Preload	Avail date
2738-22U	T9400	2.53	4GB	13.3"	WXGA Glossy	Cam	9300M 320G 5400	Blu-ray™	Intel 5100	AT&T ²³	2G Turbo	Blue	6 Ult 32	Aug 08
2738-23U	P8600	2.40	2GB	13.3"	WXGA Glossy	Cam	9300M 250G 5400	DVD±RW	Intel 5100	AT&T	2G Turbo	Blue	6 Bus 32	Aug 08
2738-42U	P8400	2.26	2GB	13.3"	WXGA Glossy	Cam	9300M 160G 5400	DVD±RW	Intel 5100	AT&T		Blue	6 Bus 32	Aug 08
2738-46U	P8400	2.26	2GB	13.3"	WXGA Glossy	Cam	9300M 160G 5400	DVD±RW	Intel 5100	WWAN upg		Blue	6 Bus 32	Aug 08
2738-7CUP	P8600	2.40	2GB	13.3"	WXGA Glossy	Cam	9300M 250G 5400	DVD±RW	Intel 5100	AT&T		Blue	6 XP Pro	Aug 08
2738-7DUP	P8400	2.26	2GB	13.3"	WXGA Glossy	Cam	9300M 160G 5400	DVD±RW	Intel 5100	WWAN upg		Blue	6 XP Pro	Aug 08

- These small and medium business (SMB) models are part of the US TopSeller™ Program
- A comprehensive computing solution for small and medium business
- Balanced between serious business computing and powerful multimedia features

Processor	Intel Core 2 Duo processor P8400, P8600, or T9400 with dual-core, Intel HD boost, 1066MHz system bus; P8400/P8600: 3MB L2 cache; T9400: 6MB L2 cache										Preloaded operating system ²⁰			
Memory	2GB or 4GB std / 4GB max ⁷ / PC2-5300 667MHz DDR2, non-parity, dual-channel capable, two 200-pin SO-DIMM sockets; <i>Italics:</i> standard memory in both sockets; no sockets available; <i>Non-italics:</i> standard memory in one socket; one socket available										- Some: Microsoft® Windows® XP Professional with Vista® COA - Some: Microsoft Windows Vista Business Edition (32-bit) - Some: Microsoft Windows Vista Ultimate Edition (32-bit)			
SATA DVD±RW SATA Blu-ray SATA disk	Some: DVD burner, SATA 1.5Gb/s, 12.7mm high, fixed, not removable, tray-in Some: Blu-ray burner, SATA 1.5Gb/s, 12.7mm high, fixed, not removable, tray-in 160GB ⁸ (5400 rpm), 250GB ⁸ (5400 rpm), or 320GB ⁸ (5400 rpm) / SATA 1.5Gb/s, 9.5mm high, removable, upgradable, ThinkPad Shock Mounted Hard Drive, Active Protection System™										◇ XP Pro models: Vista Basic logo ◇ Vista models: Vista Premium logo			
Widescreen display Camera	13.3" (338mm) WXGA (1280x800) color, VibrantView (glossy), LED backlight, 300 nits, 16:10 aspect ratio, 300:1 contrast ratio Camera on top of screen, 1.3-megapixel, fixed focus										Preloaded applications ¹⁴ (all OSes)			
Discrete graphics	NVIDIA® GeForce 9300M, PCI Express® x16, 128MB memory, HDMI port supporting HDCP to output protected content; <i>Max external resolution:</i> 2048x1536@85Hz (VGA DB-15 port); 1920x1080 (HDMI port)										<ul style="list-style-type: none"> • Lenovo Care™ Tools • Rescue and Recovery™ • Access Connections™ • Password Manager • System Update • McAfee VirusScan® Plus with SiteAdvisor™ (30 days of virus definitions) • PC-Doctor™ (diagnostics) • ThinkPad Utilities (Power Manager and Presentation Director) • Adobe® Reader • Windows Live™ Toolbar • Windows Live Search • Fingerprint Software • Microsoft Office 2007 Trial (60-day) • Roxio® Creator® Small Business Edition • Roxio MyDVD® (DVD±RW) 			
Keyboard TrackPoint® Touch pad Lighting FX	89-key, Lenovo Care button, spill-resistant, multimedia Fn keys TrackPoint® pointing device, Internet Scroll Bar ¹³ , magnifying glass UltraNav™, wide touch pad below keyboard, Tap Zones, scrolling regions label Illuminated power button, Lenovo Care button, and red dot on ThinkPad logo													
Dimensions ³ Weight ² Case color Case material Battery - type Battery - life ¹⁰	6-cell (WxDxH): 12.5" x 9.4" x 1.18–1.33"; 318mm x 238mm x 30–34mm 6-cell: starting at 4.76 lb (2.16kg) Black Scratch-resistant ABS plastic, high-gloss top cover Lithium Ion 6-cell 6-cell: up to 4.5 hr													
Chipset	Mobile Intel GM45 Express Chipset (Graphics Memory Controller Hub), ICH9M I/O Controller Hub (SATA 3.0Gb/s, USB 2.0, PCI Express® 1.1, PCI 2.3, security chip, ethernet MAC), LPC bus (IT8752 Super I/O)													
ExpressCard/54 Multicard reader PC Card Smart Card read Ports	One slot (ExpressCard/34, ExpressCard/54) 7-in-1 reader (MMC, Memory Stick, Mem Stick PRO™, SD, SDHC, XD, XD Type H) None None Three USB 2.0, external monitor (VGA DB-15, HDMI), modem (RJ-11), ethernet (RJ-45), IEEE 1394 FireWire 400 (4-pin connector; 1394a-2000 standard)													
Mini PCI Express Intel 5100 ²⁸ WWAN upg AT&T ²³ 2G Turbo UWB Modem Bluetooth™ Ethernet Intel AMT Audio support Security Security chip Fingerprint reader	Three Mini PCI Express slots 11a/b/g/n wireless ⁴ , Mini PCIe adapter, Intel WiFi Link 5100, 1x2 (Shirley Peak) Some: Wireless WAN upgradable, optional AT&T® (43R9152) Some: Wireless WAN, Ericsson chipset, Mini PCIe adapter and SIM, GPRS/WCDMA/HSPA, GPS, service contract required with AT&T® Some: Intel Turbo Memory, Half-Mini PCIe adapter, 2GB flash, disk-cache accelerator None 56K V.92 ⁶ modem Bluetooth 2.0 wireless, LED indicator Realtek RTL8111C Gigabit Network Connection, PHY, PCIe x1 None High Definition (HD) Audio, CX20561-15Z codec / stereo speakers, 1.5 watt / volume up, down, mute buttons / dual array microphone, mic input jack, headphone jack Power-on password, hard disk password, supervisor password, security keyhole None Fingerprint reader on palm rest, swipe sensor, supports the security chip										90-watt (NVIDIA graphics) AC adapter EPEAT™ Gold rating ENERGY STAR® 4.0-compliant RoHS-compliant International Warranty Service ¹⁷ 24 hour x 7 day ¹⁸ toll-free support during the warranty period ¹² via 800-426-7378			
Limited warranty ¹²	1-year - EasyServ™ ¹⁹ depot repair service / service upgrades ²² available										ThinkPlus™. ²² 1-year LOR ²⁴ 9x5 NBD 41C9166 ThinkPlus 2-year LOR 9x5 NBD 41C9167 ThinkPlus 3-year LOR 9x5 NBD 41C9168 ThinkPlus 4-year LOR 9x5 NBD 41C9171 ThinkPlus 2-year P&L P/U Depot 41C9169 ThinkPlus 3-year P&L P/U Depot 41C9170 ThinkPlus 4-year P&L P/U Depot 41C9172 Post-warranty annual maintenance agreements at lenovo.com/thinkplus/warranty			
1GB PC2-5300 DDR2 SODIMM (TopSeller) 2GB PC2-5300 DDR2 SODIMM (TopSeller) SL 320GB Disk SATA 1.5Gb/s (5400 rpm) USB 2.0 Ultra Secure Memory Key 8GB USB 2.0 Lenovo Enhanced Port Replicator Laser Tilt Wheel Travel Mouse (Bluetooth) AT&T HSPA WWAN (Ericsson) Mini PCIe Other accessories on O-SL300 sheet	43R1999 43R2000 43N3405 45J5918 43R8770 41U5008 43R9152										SL300 Series Li-Ion Battery 4-cell 43R9252 T/R/W/SL Series Li-Ion Battery 6-cell 40Y6799 T/R/W/SL Series Li-Ion Battery 9-cell 40Y6797 ThinkPad Basic Case 43R9113 ThinkPad Business Backpack 43R2482 ThinkVision® L2240p Wide 22" Monitor 4422HB6 ThinkVision L2440p Wide 24" Monitor 4420HB2 Other accessories at lenovo.com/accessories			

See footnotes for important warranty information

Intel Centrino 2 processor technology

US models announced August 19, 2008; previous models on August 12, 2008

US models withdrawn effective September 2008

© Lenovo
(CAR1-2) December 2008

Partial list of accessories supported on:
• ThinkPad SL300 originally announced on August 12, 2008

Memory

512MB PC2-5300 DDR2 SODIMM	40Y7733	ann	01/05/06
1GB PC2-5300 DDR2 SODIMM (TopSeller)	43R1999	ann	03/25/08
1GB PC2-5300 DDR2 SODIMM	40Y7734	ann	01/05/06
2GB PC2-5300 DDR2 SODIMM (TopSeller)	43R2000	ann	03/25/08
2GB PC2-5300 DDR2 SODIMM	40Y7735	ann	11/28/06

Storage and removable storage

SL 320GB Disk SATA 1.5Gb/s (5400 rpm)	43N3405	ann	07/15/08
USB 2.0 Essential Memory Key 2GB	41U4944	ann	01/23/07
USB 2.0 Essential Memory Key 4GB	45J7904	ann	06/24/08
USB 2.0 Essential Memory Key 8GB	45J7905	ann	07/15/08
USB 2.0 Essential Memory Key 32GB	45K1258	ann	10/28/08
USB 2.0 Security Memory Key 2GB	41U5119	ann	07/17/07
USB 2.0 Security Memory Key 4GB	41U5120	ann	07/17/07
USB 2.0 Ultra Secure Memory Key 1GB	45J5915	ann	08/26/08
USB 2.0 Ultra Secure Memory Key 2GB	45J5916	ann	08/26/08
USB 2.0 Ultra Secure Memory Key 4GB	45J5917	ann	08/26/08
USB 2.0 Ultra Secure Memory Key 8GB	45J5918	ann	08/26/08
USB Portable Diskette Drive	05K9276	ann	06/05/00
USB 2.0 CD-RW/DVD-ROM Combo II Drive	40Y8637	ann	01/05/06
USB 2.0 Portable 160GB Hard Disk	43R1784	ann	09/23/08
USB 2.0 Portable Secure 160GB Hard Disk	43R2018	ann	11/18/08
USB 2.0 Portable Secure 320GB Hard Disk	43R2019	ann	11/18/08
USB 2.0 Super Multi-Burner Drive	41N5565	ann	01/23/07

Wireless WAN (Mini PCI Express)

Only WWAN upgradable models:

AT&T WWAN HSPA Broadband Mini PCIe	43R9152	ann	08/26/08
------------------------------------	---------	-----	----------

ThinkPad Expansion

USB 2.0 Lenovo Enhanced Port Replicator	43R8770	ann	02/26/08
ThinkPad Adjustable Notebook Stand	40Y7676	ann	09/20/05

Keyboard

TrackPoint Cap Collection	73P2698	ann	12/16/03
USB Numeric Keypad	33L3225	ann	05/01/00
Preferred Pro USB Keyboard	73P5220	ann	06/21/05
Enhanced Performance USB Keyboard	73P2620	ann	03/23/04
Wireless Kybd & Opt Wheel Mouse (via USB)	73P4067	ann	12/07/04
USB Keyboard with UltraNav	31P8950	ann	01/28/03
USB Travel Keyboard with UltraNav	31P9490	ann	04/27/04
Preferred Pro USB Fingerprint Keyboard	73P4730	ann	02/22/05

Mouse

Optical Wheel Mouse (USB)	06P4069	ann	05/21/03
Optical ScrollPoint® Mouse (USB, PS/2)	31P7405	ann	08/27/02
Optical Wheel Travel Mouse (USB, PS/2)	31P7410	ann	06/04/02
Laser Tilt Wheel Mouse (USB, PS/2)	41U3074	ann	01/23/07
Lenovo Wireless Laser Mouse (blk, via USB)	45K1696	ann	11/25/08
Lenovo Wireless Laser Mouse (red, via USB)	51J0198	ann	11/25/08
Laser Tilt Wheel Travel Mouse (Bluetooth)	41U5008	ann	01/22/08

Security

Kensington® Cable Lock from Lenovo	73P2582	ann	12/29/03
Kensington Twin Head Cable Lock	45K1620	ann	09/30/08
USB Gemplus GemPC Smart Card Reader	41N3040	ann	02/21/06
ExpressCard Gemplus Smart Card Reader ⁴⁷	41N3043	ann	06/27/06

⁴⁷ Requires ExpressCard slot

Multimedia

USB 2.0 Lenovo Multimedia Headset	40Y8518	ann	06/27/06
USB 2.0 Lenovo Webcam	40Y8519	ann	08/29/06

Batteries

SL300 Series Li-Ion Battery 4-cell	43R9252	ann	08/12/08
T/R/W/SL Series Li-Ion Battery 6-cell	40Y6799	ann	01/05/06
T/R/W/SL Series Li-Ion Battery 9-cell	40Y6797	ann	09/20/05
ThinkPad External Battery Charger ⁴⁴	40Y7625	ann	09/20/05

⁴⁴ Requires the *ThinkPad 90W AC Adapter 40Y7659* (adapter provided with some systems).

More information at www.lenovo.com/alldaycomputing

ThinkPad 65W AC Adapter ⁴⁵	40Y7696		
⁴⁵ Only compatible with the GM45 chipset models.			
ThinkPad 90W AC Adapter	40Y7659	ann	09/20/05

More info at www.lenovo.com/support/poweradapters

Carrying Cases

Up to 13.3" widescreen models:

ThinkPad Ultraportable Case	41U5062	ann	05/13/08
-----------------------------	---------	-----	----------

Up to 14.1" widescreen models:

ThinkPad Expander Case	43R9118	ann	06/24/08
ThinkPad Women's Microfiber Tote	22P8855		
ThinkPad Women's Leather Trim Tote	22P8856		
ThinkPad Convertible Carrying Case	22P8860		
ThinkPad Women's Executive Leather Tote	22P8857		
Women's Executive Red Leather Tote	22P8858		

Up to 15.4" widescreen models:

Lenovo Carrying Case - Messenger Max	41U5253	ann	05/01/07
Lenovo Carr Case - Performance Backpack	41U5254	ann	05/01/07
Lenovo Standard Case	45K1697	ann	11/25/08
Lenovo Standard Backpack	45K1698	ann	11/25/08
ThinkPad Business Topload Case	43R2476	ann	05/13/08
ThinkPad Business Backpack	43R2482	ann	05/13/08
ThinkPad Deluxe Expander Case	43R2478	ann	05/13/08
ThinkPad Executive Leather Case	43R2480	ann	05/13/08

Up to 17.0" widescreen models:

ThinkPad 17W Business Topload Case	43R9117	ann	08/12/08
------------------------------------	---------	-----	----------

Lenovo luxury cases at www.lenovoluxurycases.com

Monitors

ThinkVision® L174 17" Monitor	9227AE1	ann	04/15/08
ThinkVision L1700p 17" Monitor	9417HE2	ann	09/17/08
ThinkVision L1900p 19" Monitor	4431HE1	ann	11/11/08
ThinkVision L1940p Wide 19" Monitor	4424HB6	ann	09/17/08
ThinkVision L200p Wide 20.1" Monitor	4438HB6	ann	04/15/08
ThinkVision L2240p Wide 22" Monitor	4422HB6	ann	09/17/08
ThinkVision L2440p Wide 24" Monitor	4420HB2	ann	09/17/08
ThinkVision L2440x Wide 24" Monitor	4421HB2	ann	09/17/08

Monitor Accessories⁴⁶

ThinkVision USB Soundbar	40Y7616	ann	08/23/05
ThinkVision Soundbar	45K1263	ann	09/16/08
Kensington Cable Lock from Lenovo	73P2582	ann	12/29/03
Kensington Twin Head Cable Lock	45K1620	ann	09/30/08
ThinkPad Convertible Monitor Stand	40Y7620	ann	01/05/06
Radial Arm	19K4464	ann	05/05/00

⁴⁶ Compatible on selected Lenovo and ThinkVision monitors.

More information at www.lenovo.com/support/monitoraccessories

Other accessories at www.lenovo.com/accessories

Accessories Guide pdf at www.lenovo.com/accessoriesguide

ThinkPad®



Lenovo ThinkPad SL400



Lenovo ThinkPad SL400



Lenovo ThinkPad SL400



Lenovo ThinkPad SL400



Lenovo ThinkPad SL400



Lenovo ThinkPad SL400

ThinkPad® SL400 2743 (GMA) - TopSeller (Celeron)

Personal Systems Reference (PSREF)

Type-model	Celeron processor	GHz	Memory	Wide-screen display	Screen type	Camera	Integrated graphics	Disk SATA GB ⁵ rpm	SATA optical	Mini PCIe 802.11 wireless	Mini PCIe WWAN	Mini PCIe UWB or Turbo	Battery Blue-tooth cells	Preload	Avail date
2743-9YU	Cel 585	2.16	1GB	14.1" WXGA	Glossy	None	GMA	80G 5400	DVD±RW	11b/g ³²	WWAN upg	None	None	6	Home B Aug 08
2743-9ZU	Cel 585	2.16	1GB	14.1" WXGA		None	GMA	160G 5400	DVD±RW	11b/g	WWAN upg	None	None	6	XP Pro Aug 08
2743-B2U	Cel T1600	1.66	1GB	14.1" WXGA		None	GMA	160G 5400	DVD±RW	11b/g	WWAN upg	None	None	6	XP Pro Sep 08

- **These small and medium business (SMB) models are part of the US TopSeller™ Program**
- **A comprehensive computing solution for small and medium business**
- **Balanced between serious business computing and powerful multimedia features**

Processor	Intel® Celeron® Processor 585 with single-core, 667MHz system bus, and 1MB L2 cache or Intel Celeron Processor T1600 with dual-core, 667MHz system bus, and 1MB L2 cache										Preloaded operating system²⁰ - Some: Microsoft® Windows® XP Professional with Vista® COA - Some: Microsoft Windows Vista Home Basic Edition (32-bit) ◇ Vista Basic logo					
Memory	1GB or 2GB std / 4GB max ⁷ / PC2-5300 667MHz DDR2, non-parity, dual-channel capable, two 200-pin SO-DIMM sockets; <i>Non-italics:</i> standard memory in one socket; one socket available										◆ Vista Basic logo					
SATA DVD±RW SATA disk	DVD burner, SATA 1.5Gb/s, 12.7mm high, fixed, not removable, tray-in 80GB⁸ (5400 rpm) or 160GB (5400 rpm) / SATA 1.5Gb/s, 9.5mm high, removable, upgradable, ThinkPad Shock Mounted Hard Drive, Active Protection System™										Preloaded applications¹⁴ (all OSes) • Lenovo Care™ Tools • Rescue and Recovery™ • Access Connections™ • Password Manager • System Update • McAfee VirusScan® Plus with SiteAdvisor™ (30 days of virus definitions) • PC-Doctor™ (diagnostics) • ThinkPad Utilities (Power Manager and Presentation Director) • Adobe® Reader • Windows Live™ Toolbar • Windows Live Search • Fingerprint Software • Microsoft Office 2007 Trial (60-day) • Roxio® Creator® Small Business Edition • Roxio MyDVD® (DVD±RW)					
Widescreen display	<i>Some:</i> 14.1" (358.1mm) WXGA (1280x800) color , anti-glare, CCFL backlight, 200 nits, 16:10 aspect ratio, 300:1 contrast ratio <i>Some:</i> 14.1" (358.1mm) WXGA (1280x800) color, VibrantView (glossy), CCFL backlight, 200 nits, 16:10 aspect ratio, 300:1 contrast ratio															
Camera	None															
Integrated graphics	Intel Graphics Media Accelerator 4500M (GMA 4500M) , in GL40, HDMI port supporting HDCP to output protected content; <i>Max external resolution:</i> 2048x1536@75Hz (DB-15 port); 1920x1080 (HDMI port)															
Keyboard TrackPoint® Touch pad Lighting FX	89-key, Lenovo Care button, spill-resistant, multimedia Fn keys, Windows/Appl keys TrackPoint® pointing device, Internet Scroll Bar ¹³ , magnifying glass UltraNav™, wide touch pad below keyboard, Tap Zones, scrolling regions label Illuminated power button, Lenovo Care button, and red dot on ThinkPad logo															
Dimensions ³ Weight ² Case Battery - type Battery - life ¹⁰	<i>6-cell 14.1W"</i> (WxDxH): 13.2" x 9.7" x 1.34–1.46"; 336mm x 247mm x 34–37mm <i>6-cell:</i> starting at 5.5 lb (2.5kg) <i>Color:</i> black; <i>Material:</i> scratch-resistant ABS plastic, high-gloss top cover Lithium Ion 6-cell <i>6-cell:</i> up to 4.1 hr; <i>9-cell:</i> up to 6 hr															
Chipset	Mobile Intel GL40 Express Chipset (Graphics Memory Controller Hub), ICH9M I/O Controller Hub (SATA 3.0Gb/s, USB 2.0, PCI Express® 1.1, PCI 2.3, security chip, ethernet MAC), LPC bus (IT8752 Super I/O)															
ExpressCard Multicard Reader PC Card Std Smart Card Read Ports	One slot (ExpressCard/34, ExpressCard/54) 7-in-1 reader (MMC, Memory Stick, Mem Stick Pro, SD, SDHC, XD, XD Type H) None None Four USB 2.0, external monitor (VGA DB-15, HDMI), modem (RJ-11), ethernet (RJ-45), IEEE 1394 FireWire 400 (4-pin connector; 1394a-2000 standard)															
Mini PCI Express 11b/g ³² WWAN upg 2G Turbo UWB Modem Bluetooth™ Ethernet Intel AMT Audio support	Three Mini PCI Express slots 11b/g wireless ⁴ , ThinkPad 11b/g Mini PCIe Adapter III, Atheros AR5007EG Wireless WAN upgradable, optional AT&T® (43R9152) None None 56K V.92 ⁶ modem None Realtek RTL8111C Gigabit Network Connection, PHY, PCIe x1 None High Definition (HD) Audio, CX20561-15Z codec / stereo speakers, 2 watt / volume up, down, mute buttons / dual array microphone, mic input jack, headphone jack										65-watt (GMA graphics) AC adapter EPEAT™ Silver rating RoHS-compliant International Warranty Service ¹⁷ 24 hour x 7 day ¹⁸ toll-free support during the warranty period ¹² via 800-426-7378					
Security Security chip Fingerprint reader	Power-on password, hard disk password, supervisor password, security keyhole None None										ThinkPlus™.22 1-year LOR ²⁴ 9x5 NBD 41C9166 ThinkPlus 2-year LOR 9x5 NBD 41C9167 ThinkPlus 3-year LOR 9x5 NBD 41C9168 ThinkPlus 4-year LOR 9x5 NBD 41C9171 ThinkPlus 2-year P&L P/U Depot 41C9169 ThinkPlus 3-year P&L P/U Depot 41C9170 ThinkPlus 4-year P&L P/U Depot 41C9172					
Limited warranty ¹²	1-year - EasyServ™.19 depot repair service / service upgrades ²² available										Post-warranty annual maintenance agreements at lenovo.com/thinkplus/warranty					
	1GB PC2-5300 DDR2 SODIMM (TopSeller)	43R1999	T/R/W/SL Series Li-Ion Battery 6-cell	40Y6799												
	2GB PC2-5300 DDR2 SODIMM (TopSeller)	43R2000	T/R/W/SL Series Li-Ion Battery 9-cell	40Y6797												
	SL 320GB Disk SATA 1.5Gb/s (5400 rpm)	43N3405	ThinkPad External Battery Charger	40Y7625												
	USB 2.0 Lenovo Multimedia Headset	40Y8518	ThinkPad 90W AC Adapter	40Y7659												
	USB 2.0 Lenovo Webcam	40Y8519	90W Slim AC/DC Combo Adapter	41N8460												
	USB 2.0 Essential Memory Key 32GB	45K1258	ThinkPad Basic Case	43R9113												
	USB 2.0 Security Memory Key 4GB	41U5120	ThinkPad Business Topload Case	43R2476												
	USB 2.0 Portable Secure 320GB Hard Disk	43R2019	ThinkPad Business Backpack	43R2482												
	USB 2.0 Lenovo Enhanced Port Replicator	43R8770	ThinkVision® L1940p Wide 19" Monitor	4424HB6												
	ThinkPad Convertible Monitor Stand	40Y7620	ThinkVision L2240p Wide 22" Monitor	4422HB6												
	Laser Tilt Wheel Travel Mouse (Bluetooth)	41U5008	ThinkVision L2440x Wide 24" Monitor	4421HB2												
	Other accessories on O-SL400 sheet		Other accessories at lenovo.com/accessories													

See footnotes for important warranty information

US model announced September 30, 2008; previous models on August 20, 2008

© Lenovo

(CAY1-3) September 2008

ThinkPad® SL400 2743 (GMA) - TopSeller

Personal Systems Reference (PSREF)

Type-model	Processor	GHz	Memory	Wide-screen display	Screen type	Cam-era	Integrated graphics	Disk SATA GB ⁵ rpm	SATA optical	Mini PCIe 802.11 wireless	Mini PCIe WWAN	Mini PCIe UWB or Turbo	Bat-tery Blue-tooth cells	Preload	Avail date	
2743-48U T5670	1.80	2GB	14.1"	WXGA			GMA	250G 5400	DVD±RW	* Intel 5100 ²⁸	AT&T ²³		6	Bus 32	July 08	
2743-49U T5670	1.80	2GB	14.1"	WXGA	Glossy	Cam	GMA	250G 5400	DVD±RW	* Intel 5100	AT&T		Blue	6	Home P	July 08
2743-4AU T5670	1.80	2GB	14.1"	WXGA			GMA	250G 5400	DVD±RW	* Intel 5100	WWAN upg		6	Bus 32	July 08	
2743-4BU T5670	1.80	2GB	14.1"	WXGA	Glossy	Cam	GMA	250G 5400	DVD±RW	* Intel 5100	WWAN upg		Blue	6	Home P	July 08
2743-42U P8400	2.26	1GB	14.1"	WXGA			GMA	160G 5400	Combo	Intel 5100	AT&T		6	Bus 32	July 08	
2743-43U P8400	2.26	2GB	14.1"	WXGA			GMA	160G 5400	DVD±RW	Intel 5100	AT&T		6	Bus 32	July 08	
2743-45U P8400	2.26	1GB	14.1"	WXGA			GMA	160G 5400	Combo	Intel 5100	WWAN upg		6	Bus 32	July 08	
2743-46U P8400	2.26	2GB	14.1"	WXGA			GMA	160G 5400	DVD±RW	Intel 5100	WWAN upg		6	Bus 32	July 08	
2743-23U P8600	2.40	2GB	14.1"	WXGA		Cam	GMA	160G 5400	DVD±RW	Intel 5100	AT&T		Blue	6	Home P	July 08
2743-26U P8600	2.40	2GB	14.1"	WXGA		Cam	GMA	160G 5400	DVD±RW	Intel 5100	WWAN upg	2G Turbo	Blue	6	Bus 32	July 08
2743-7ZU P8400	2.26	2GB	14.1"	WXGA			GMA	160G 5400	DVD±RW	Intel 5100	AT&T		Blue	6	XP Pro	Aug 08
2743-83U P8400	2.26	2GB	14.1"	WXGA			GMA	160G 5400	DVD±RW	Intel 5100	WWAN upg		6	XP Pro	Aug 08	
2743-86U T5670	1.80	2GB	14.1"	WXGA			GMA	250G 5400	DVD±RW	* Intel 5100	WWAN upg		6	XP Pro	Aug 08	
2743-89U P8400	2.26	2GB	14.1"	WXGA		Cam	GMA	250G 5400	DVD±RW	Intel 5100	WWAN upg		Blue	6	XP Pro	Aug 08
2743-8CUP8600	2.40	2GB	14.1"	WXGA		Cam	GMA	160G 5400	DVD±RW	Intel 5100	WWAN upg		Blue	6	XP Pro	Aug 08
2743-6DUP7370	2.00	2GB	14.1"	WXGA			GMA	250G 5400	DVD±RW	Intel 5100	WWAN upg		6	XP Pro	Sep 08	
2743-6AU T5870	2.00	2GB	14.1"	WXGA		Cam	GMA	250G 5400	DVD±RW	Intel 5100	WWAN upg		Blue	6	XP Pro	Oct 08

• These small and medium business (SMB) models are part of the US TopSeller™ Program

Processor	Intel® Core™ 2 Duo processor T5670 or T5870 with dual-core, 800MHz system bus, and 2MB L2 cache or Intel Core 2 Duo processor P7370, P8400, or P8600 with dual-core, Intel HD boost, 1066MHz system bus, and 3MB L2 cache	Preloaded operating system ²⁰ - Some: Microsoft® Windows® XP Professional with Vista® COA
Memory	1GB or 2GB std / 4GB max ⁷ / PC2-5300 667MHz DDR2, non-parity, dual-channel capable, two 200-pin SO-DIMM sockets; <i>Italics:</i> standard memory in both sockets; no sockets available; <i>Non-italics:</i> standard memory in one socket; one socket available	- Some: Microsoft Windows Vista Business Edition (32-bit) - Some: Microsoft Windows Vista Ultimate Edition (32-bit) ◇ 42U/45U/XP Pro models: Vista Basic logo ◇ 2GB Vista models: Vista Premium logo
SATA Combo SATA DVD±RW SATA disk	Some: DVD-ROM/CD-RW, SATA 1.5Gb/s, 12.7mm high, fixed, not removable, tray-in Some: DVD burner, SATA 1.5Gb/s, 12.7mm high, fixed, not removable, tray-in 160GB ⁸ (5400 rpm), 250GB (5400 rpm) / SATA 1.5Gb/s, 9.5mm high, removable, upgradable, ThinkPad Shock Mounted Hard Drive, Active Protection System™	Preloaded applications ¹⁴ (all OSes) • Lenovo Care™ Tools • Rescue and Recovery™ • Access Connections™ • Password Manager • System Update • McAfee VirusScan® Plus with SiteAdvisor™ (30 days of virus definitions) • PC-Doctor™ (diagnostics) • ThinkPad Utilities • Adobe® Reader • Windows Live™ Toolbar and Search • Fingerprint Software • Microsoft Office 2007 Trial (60-day) • Roxio® Creator® Small Business Edition • Roxio MyDVD® (DVD±RW)
Widescreen display	Some: 14.1" (358.1mm) WXGA (1280x800) color, anti-glare, CCFL backlight, 200 nits, 16:10 aspect ratio, 300:1 contrast ratio Some: 14.1" (358.1mm) WXGA (1280x800) color, VibrantView (glossy), CCFL backlight, 200 nits, 16:10 aspect ratio, 300:1 contrast ratio	
Camera	Some: camera on top of screen, 2.0-megapixel, fixed focus	
Integrated graphics	Intel Graphics Media Accelerator 4500MHD (GMA 4500MHD), in GM45, HDMI port supporting HDCP to output protected content; Max external resolution: 2048x1536@75Hz (VGA); 1920x1080 (HDMI)	
Keyboard TrackPoint® Touch pad Lighting FX	89-key, Lenovo Care button, spill-resistant, multimedia Fn keys TrackPoint® pointing device, Internet Scroll Bar ¹³ , magnifying glass UltraNav™, wide touch pad below keyboard, Tap Zones, scrolling regions label Illuminated power button, Lenovo Care button, and red dot on ThinkPad logo	
Dimensions ³ Weight ² Case Battery - type Battery - life ¹⁰	6-cell 14.1W" (WxDxH): 13.2" x 9.7" x 1.34–1.46"; 336mm x 247mm x 34–37mm 6-cell: starting at 5.5 lb (2.5kg) Color: black; Material: scratch-resistant ABS plastic, high-gloss top cover Lithium Ion 6-cell 6-cell: up to 4.1 hr; 9-cell: up to 6 hr	
Chipset	Mobile Intel GM45 Express Chipset (Graphics Memory Controller Hub), ICH9M I/O Controller Hub (SATA 3.0Gb/s, USB 2.0, PCI Express® 1.1, PCI 2.3, security chip, ethernet MAC), LPC bus (IT8752 Super I/O)	65-watt (GMA graphics) AC adapter EPEAT™ Silver rating ENERGY STAR® 4.0-compliant RoHS-compliant International Warranty Service ¹⁷ 24 hour x 7 day ¹⁸ toll-free support during the warranty period ¹² via 800-426-7378
ExpressCard Multicard Reader PC Card Std Smart Card Read	One slot (ExpressCard/34, ExpressCard/54) 7-in-1 reader (MMC, Memory Stick, Mem Stick Pro, SD, SDHC, XD, XD Type H) None None	
Ports	Four USB 2.0, external monitor (VGA DB-15, HDMI), modem (RJ-11), ethernet (RJ-45), IEEE 1394 FireWire 400 (4-pin connector; 1394a-2000 standard)	
Mini PCI Express Intel 5100 ²⁸ WWAN upg AT&T ²³ 2G Turbo UWB Modem Bluetooth™ Ethernet Intel AMT Audio support Security Security chip Fingerprint reader	Three Mini PCI Express slots 11a/b/g/n wireless ⁴ , Mini PCIe adapter, Intel WiFi Link 5100, 1x2 (Shirley Peak) Some: Wireless WAN upgradable, optional AT&T® (43R9152) Some: Wireless WAN, Ericsson chipset, Mini PCIe adapter and SIM, GPRS/WCDMA/HSPA, GPS, service contract required with AT&T® Some: Intel Turbo Memory, Half-Mini PCIe adapter, 2GB flash, disk-cache accelerator None 56K V.92 ⁶ modem Some: Bluetooth 2.0 wireless, LED indicator Realtek RTL8111C Gigabit Network Connection, PHY, PCIe x1 None High Definition (HD) Audio, CX20561-15Z codec / stereo speakers, 2 watt / volume up, down, mute buttons / dual array microphone, mic input jack, headphone jack Power-on password, hard disk password, supervisor password, security keyhole None Fingerprint reader on palm rest, swipe sensor, supports the security chip	ThinkPlus™.22 1-year LOR ²⁴ 9x5 NBD 41C9166 ThinkPlus 2-year LOR 9x5 NBD 41C9167 ThinkPlus 3-year LOR 9x5 NBD 41C9168 ThinkPlus 4-year LOR 9x5 NBD 41C9171 ThinkPlus 2-year P&L P/U Depot 41C9169 ThinkPlus 3-year P&L P/U Depot 41C9170 ThinkPlus 4-year P&L P/U Depot 41C9172 Post-warranty annual maintenance agreements at lenovo.com/thinkplus/warranty
Limited warranty ¹²	1-year - EasyServ™.19 depot repair service / service upgrades ²² available	

See footnotes for important warranty information

* Intel Centrino® processor technology

© Lenovo

US model announced October 7, 2008;

Intel Centrino 2 processor technology

(CAY1-1) October 2008

previous models on July 15, July 29, or September 30, 2008

US models withdrawn effective September 2008 or January 2009

ThinkPad® SL400 2743 (GMA) - TopSeller (January 2009)

Personal Systems Reference (PSREF)

Proc- Type-model	essor GHz	Memory	Wide- screen display	Screen type	Cam- era	Integrated graphics	Disk SATA GB ⁸ rpm	SATA optical	Mini PCIe 802.11 wireless	Mini PCIe WWAN	Mini PCIe UWB or Turbo	Finger print reader	Bat- tery Pre- load	Avail date	
2743-6GU	T5870	2.00	2GB	14.1"	WXGA		GMA 250G 5400	DVD±RW	* Intel 5100 ²⁸	WWAN upg	None	Fing 6	XP Pro	Dec08	
2743-6HU	T5870	2.00	2GB	14.1"	WXGA		GMA 250G 5400	DVD±RW	* Intel 5100	WWAN upg	None	Fing 6	Bus 32	Dec08	
2743-6JU	T5870	2.00	3GB	14.1"	WXGA	Glossy Cam	GMA 250G 5400	DVD±RW	* Intel 5100	WWAN upg	None	Blue	6 Home P	Dec08	
2743-3WU	P8600	2.40	2GB	14.1"	WXGA	Cam	GMA 160G 5400	DVD±RW	✧ Intel 5100	WWAN upg	None	Fing 6	Home P	Dec08	
2743-H2U	P8600	2.40	2GB	14.1"	WXGA		GMA 160G 5400	DVD±RW	✧ WiMAX	WWAN upg	None	Fing 6	Bus 32	Jan 09	
2743-H3U	P8600	2.40	3GB	14.1"	WXGA	Cam	GMA 160G 5400	DVD±RW	✧ Intel 5100	WWAN upg	None	Blue	Fing 6	XP Pro	Jan 09

• These small and medium business (SMB) models are part of the US TopSeller™ Program

Processor	Intel® Core™ 2 Duo processor T5870 with dual-core, 800MHz system bus, and 2MB L2 cache or Intel Core 2 Duo processor P8600 with dual-core, Intel HD boost, 1066MHz system bus, and 3MB L2 cache										Preloaded operating system²⁰ - Some: Microsoft® Windows® XP Professional with Vista® COA - Some: Microsoft Windows Vista Business Edition (32-bit) - Some: Microsoft Windows Vista Ultimate Edition (32-bit) ✧ 3WU model: Vista Premium logo ✧ Other models: Vista Basic logo			
Memory	2GB or 3GB std / 4GB max ⁷ / PC2-5300 667MHz DDR2, non-parity, dual-channel capable, two 200-pin SO-DIMM sockets; <i>Italics:</i> standard memory in both sockets; no sockets available; <i>Non-italics:</i> standard memory in one socket; one socket available										- Some: Microsoft Windows Vista Business Edition (32-bit) - Some: Microsoft Windows Vista Ultimate Edition (32-bit) ✧ 3WU model: Vista Premium logo ✧ Other models: Vista Basic logo			
SATA DVD±RW SATA disk	DVD burner, SATA 1.5Gb/s, 12.7mm high, fixed, not removable, tray-in 160GB⁸ (5400 rpm), 250GB (5400 rpm) / SATA 1.5Gb/s, 9.5mm high, removable, upgradable, ThinkPad Shock Mounted Hard Drive, Active Protection System™										Preloaded applications¹⁴ (all OSes) • Lenovo Care™ Tools • Rescue and Recovery™ • Access Connections™ • Password Manager • System Update • McAfee VirusScan® Plus with SiteAdvisor™ (30 days of virus definitions) • PC-Doctor™ (diagnostics) • ThinkPad Utilities • Adobe® Reader • Windows Live™ Toolbar • Windows Live Search • Windows Live Mail (model 3WU) • Windows Live Messenger (model 3WU) • Windows Live Photo Gallery (model 3WU) • Fingerprint Software • Microsoft Office 2007 Trial (60-day) • Roxio® Creator® Small Business Edition • Roxio MyDVD® (DVD±RW)			
Widescreen display	<i>Some:</i> 14.1" (358.1mm) WXGA (1280x800) color , anti-glare, CCFL backlight, 200 nits, 16:10 aspect ratio, 300:1 contrast ratio <i>Some:</i> 14.1" (358.1mm) WXGA (1280x800) color, VibrantView (glossy), CCFL backlight, 200 nits, 16:10 aspect ratio, 300:1 contrast ratio													
Camera	<i>Some:</i> camera on top of screen, 2.0-megapixel, fixed focus													
Integrated graphics	Intel Graphics Media Accelerator 4500MHD (GMA 4500MHD) , in GM45, HDMI port supporting HDCP to output protected content; <i>Max external resolution:</i> 2048x1536@75Hz (VGA); 1920x1080 (HDMI)													
Keyboard TrackPoint® Touch pad Lighting FX	89-key, Lenovo Care button, spill-resistant, multimedia Fn keys TrackPoint® pointing device, Internet Scroll Bar ¹³ , magnifying glass UltraNav™, wide touch pad below keyboard, Tap Zones, scrolling regions label Illuminated power button, Lenovo Care button, and red dot on ThinkPad logo													
Dimensions ³ Weight ² Case Battery - type Battery - life ¹⁰	6-cell 14.1W ⁹ (WxDxH): 13.2" x 9.7" x 1.34–1.46"; 336mm x 247mm x 34–37mm 6-cell: starting at 5.5 lb (2.5kg) Color: black; Material: scratch-resistant ABS plastic, high-gloss top cover Lithium Ion 6-cell 6-cell: up to 4.1 hr; 9-cell: up to 6 hr													
Chipset	Mobile Intel GM45 Express Chipset (Graphics Memory Controller Hub), ICH9M I/O Controller Hub (SATA 3.0Gb/s, USB 2.0, PCI Express® 1.1, PCI 2.3, security chip, ethernet MAC), LPC bus (IT8752 Super I/O) One slot (ExpressCard/34, ExpressCard/54)													
ExpressCard Multicard Reader PC Card Std Smart Card Read Ports	7-in-1 reader (MMC, Memory Stick, Mem Stick Pro, SD, SDHC, XD, XD Type H) None None Four USB 2.0, external monitor (VGA DB-15, HDMI), modem (RJ-11), ethernet (RJ-45), IEEE 1394 FireWire 400 (4-pin connector; 1394a-2000 standard)													
Mini PCI Express Intel 5100 ²⁸ WiMAX WWAN upg AT&T ²³ 2G Turbo UWB Modem Bluetooth™ Ethernet Intel AMT Audio support Security Security chip Fingerprint reader	Three Mini PCI Express slots <i>Some:</i> 11a/b/g/n wireless ⁴ , Mini PCIe adapter, Intel WiFi Link 5100, 1x2 (Shirley Peak) <i>Some:</i> 11a/b/g/n and WiMAX wireless ⁴ , Mini PCIe adap, Intel WiMAX/WiFi Link 5150, 1x2 (300Mbps) WiFi + 1x2 WiMAX (Echo Peak) <i>Some:</i> Wireless WAN upgradable, optional AT&T® (43R9152) <i>Some:</i> Wireless WAN, Ericsson chipset, Mini PCIe adapter and SIM, GPRS/WCDMA/HSPA, GPS, service contract required with AT&T® <i>Some:</i> Intel Turbo Memory, Half-Mini PCIe adapter, 2GB flash, disk-cache accelerator None 56K V.92 ⁶ modem <i>Some:</i> Bluetooth 2.0 wireless, LED indicator Realtek RTL8111C Gigabit Network Connection, PHY, PCIe x1 None High Definition (HD) Audio, CX20561-15Z codec / stereo speakers, 2 watt / volume up, down, mute buttons / dual array microphone, mic input jack, headphone jack Power-on password, hard disk password, supervisor password, security keyhole None <i>Some:</i> Fingerprint reader on palm rest, swipe sensor, supports the security chip										65-watt (GMA graphics) AC adapter EPEAT™ Silver rating ENERGY STAR® 4.0-compliant RoHS-compliant International Warranty Service ¹⁷ 24 hour x 7 day ¹⁸ toll-free support during the warranty period ¹² via 800-426-7378			
Limited warranty ¹²	1-year - EasyServ™ ¹⁹ depot repair service / service upgrades ²² available										ThinkPlus™, 22 1-year LOR ²⁴ 9x5 NBD 41C9166 ThinkPlus 2-year LOR 9x5 NBD 41C9167 ThinkPlus 3-year LOR 9x5 NBD 41C9168 ThinkPlus 4-year LOR 9x5 NBD 41C9171 ThinkPlus 2-year P&L P/U Depot 41C9169 ThinkPlus 3-year P&L P/U Depot 41C9170 ThinkPlus 4-year P&L P/U Depot 41C9172			
	1GB PC2-5300 DDR2 SODIMM (TopSeller) 43R1999 2GB PC2-5300 DDR2 SODIMM (TopSeller) 43R2000 SL 320GB Disk SATA 1.5Gb/s (5400 rpm) 43N3405 AT&T HSPA WWAN (Ericsson) Mini PCIe 43R9152 Other accessories on O-SL300 sheet										T/R/W/SL Series Li-Ion Battery 6-cell 40Y6799 T/R/W/SL Series Li-Ion Battery 9-cell 40Y6797 ThinkPad Basic Case 43R9113 ThinkVision® L2440p Wide 24" Monitor 4420HB2 Other accessories at lenovo.com/accessories			
See footnotes for important warranty information US models announced Dec 16, 2008 or Jan 6, 2009										* Intel Centrino® processor technology ✧ Intel Centrino 2 processor technology © Lenovo (CAY11-1) January 2009				

ThinkPad® SL400 2743 (NVIDIA®) - TopSeller

Personal Systems Reference (PSREF)

Proc- Type-model	essor GHz	Memory	Wide- screen display	Screen type	Cam-Discrete era graphics	Disk SATA GB ⁸ rpm	SATA optical	Mini PCIe 802.11 wireless	Mini PCIe WWAN	Mini PCIe UWB or Turbo	Bat- tery cells	Preload	Avail date
⊗ 2743-44U	P8400	2.26 2GB	14.1" WXGA+		Cam 9300M	160G 5400	DVD±RW	⊕ Intel 5100 ²⁸	AT&T ²³		6	Business 32	July 08
2743-47U	P8400	2.26 2GB	14.1" WXGA+		Cam 9300M	160G 5400	DVD±RW	⊕ Intel 5100	WWAN upg		6	Business 32	July 08
⊗ 2743-22U	P8400	2.26 2GB	14.1" WXGA	Glossy	Cam 9300M	250G 5400	DVD±RW	⊕ Intel 5100	AT&T		6	Business 32	July 08
⊗ 2743-24U	P8600	2.40 2GB	14.1" WXGA	Glossy	Cam 9300M	250G 5400	DVD±RW	⊕ Intel 5100	AT&T	2G Turbo	6	Business 32	July 08
⊗ 2743-25U	T9400	2.53 4GB	14.1" WXGA+		Cam 9300M	320G 5400	Blu-ray™	⊕ Intel 5100	AT&T	2G Turbo	9	Ultimate 32	July 08
⊗ 2743-82U	P8400	2.26 2GB	14.1" WXGA+		Cam 9300M	160G 5400	DVD±RW	⊕ Intel 5100	AT&T ²³		6	XP Pro	Aug 08
⊗ 2743-84U	P8400	2.26 2GB	14.1" WXGA+		Cam 9300M	160G 5400	DVD±RW	⊕ Intel 5100	WWAN upg		6	XP Pro	Aug 08

• These small and medium business (SMB) models are part of the US TopSeller™ Program
 • A comprehensive computing solution for small and medium business
 • Balanced between serious business computing and powerful multimedia features

Processor	Intel® Core™ 2 Duo processor P8400, P8600, or T9400 with dual-core, Intel HD boost, 1066MHz system bus; P8400/P8600: 3MB L2 cache; T9400: 6MB L2 cache	Preloaded operating system²⁰ - Some: Microsoft® Windows® XP Professional with Vista® COA - Some: Microsoft Windows Vista Business Edition (32-bit) - Some: Microsoft Windows Vista Ultimate Edition (32-bit) ⊕ XP Pro models: Vista Basic logo ⊕ Vista models: Vista Premium logo Preloaded applications¹⁴ (all OSes) • Lenovo Care™ Tools • Rescue and Recovery™ • Access Connections™ • Password Manager • System Update • McAfee VirusScan® Plus with SiteAdvisor™ (30 days of virus definitions) • PC-Doctor™ (diagnostics) • ThinkPad Utilities (Power Manager and Presentation Director) • Adobe® Reader • Windows Live™ Toolbar • Windows Live Search • Fingerprint Software • Microsoft Office 2007 Trial (60-day) • Roxio® Creator® Small Business Edition • Roxio MyDVD® (DVD±RW, Blu-ray)		
Memory	1GB, 2GB, or 4GB std / 4GB max ⁷ / PC2-5300 667MHz DDR2, non-parity, dual-channel capable, two 200-pin SO-DIMM sockets; <i>Italics:</i> standard memory in both sockets; no sockets available; <i>Non-italics:</i> standard memory in one socket; one socket available			
SATA DVD±RW	Some: DVD burner, SATA 1.5Gb/s, 12.7mm high, fixed, not removable, tray-in			
SATA Blu-ray	Some: Blu-ray burner, SATA 1.5Gb/s, 12.7mm high, fixed, not removable, tray-in			
SATA disk	160GB ⁸ (5400 rpm), 250GB (5400 rpm), or 320GB (5400 rpm) / SATA 1.5Gb/s, 9.5mm high, removable, upgradable, ThinkPad Shock Mounted Hard Drive, Active Protection System™			
Widescreen display	Some: 14.1" (358.1mm) WXGA (1280x800) color, VibrantView (glossy), CCFL backlight, 200 nits, 16:10 aspect ratio, 300:1 contrast ratio Some: 14.1" (358.1mm) WXGA+ (1440x900) color, anti-glare, CCFL backlight, 200 nits, 16:10 aspect ratio, 300:1 contrast ratio			
Camera	Camera on top of screen, 2.0-megapixel, fixed focus			
Discrete graphics	NVIDIA® GeForce 9300M, PCI Express® x16, 256MB memory, HDMI port supporting HDCP to output protected content; Max external resolution: 2048x1536@85Hz (DB-15 port); 1920x1080 (HDMI port)			
Keyboard	89-key, Lenovo Care button, spill-resistant, multimedia Fn keys			
TrackPoint®	TrackPoint® pointing device, Internet Scroll Bar ¹³ , magnifying glass			
Touch pad	UltraNav™, wide touch pad below keyboard, Tap Zones, scrolling regions label			
Lighting FX	Illuminated power button, Lenovo Care button, and red dot on ThinkPad logo			
Dimensions ³	6-cell 14.1W" (WxDxH): 13.2" x 9.7" x 1.34–1.46"; 336mm x 247mm x 34–37mm			
Weight ²	6-cell: starting at 5.5 lb (2.5kg); 9-cell: starting at 5.9 lb (2.7kg)			
Case	Color: black; Material: scratch-resistant ABS plastic, high-gloss top cover			
Battery - type	Lithium Ion 6-cell or 9-cell			
Battery - life ¹⁰	6-cell: up to 3.6 hr; 9-cell: up to 5.5 hr			
Chipset	Mobile Intel PM45 Express Chipset (Memory Controller Hub), ICH9M I/O Controller Hub (SATA 3.0Gb/s, USB 2.0, PCI Express® 1.1, PCI 2.3, security chip, ethernet MAC), LPC bus (IT8752 Super I/O)			
ExpressCard slot	One ExpressCard/34 or ExpressCard/54			
Multicard Reader	7-in-1 reader (MMC, Memory Stick, Mem Stick Pro, SD, SDHC, XD, XD Type H)			
PC Card Std slot	None			
Smart Card Read	None			
Ports	Four USB 2.0, external monitor (VGA DB-15, HDMI), modem (RJ-11), ethernet (RJ-45), IEEE 1394 FireWire 400 (4-pin connector; 1394a-2000 standard)			
Mini PCI Express	Three Mini PCI Express slots			
Intel 5100 ²⁸	11a/b/g/n wireless ⁴ , Mini PCIe adapter, Intel WiFi Link 5100, 1x2 (Shirley Peak)			
WWAN upg	Some: Wireless WAN upgradable, optional AT&T® (43R9152)			
AT&T ²³	Some: Wireless WAN, Ericsson chipset, Mini PCIe adapter and SIM, GPRS/WCDMA/HSPA, GPS, service contract required with AT&T®			
2G Turbo	Some: Intel Turbo Memory, Half-Mini PCIe adapter, 2GB flash, disk-cache accelerator			
UWB	None			
Modem	56K V.92 ⁶ modem			
Bluetooth™	Bluetooth 2.0 wireless, LED indicator			
Ethernet	Realtek RTL8111C Gigabit Network Connection, PHY, PCIe x1			
Intel AMT	None			
Audio support	High Definition (HD) Audio, CX20561-15Z codec / stereo speakers, 2 watt / volume up, down, mute buttons / dual array microphone, mic input jack, headphone jack			
Security	Power-on password, hard disk password, supervisor password, security keyhole			
Security chip	None			
Fingerprint reader	Fingerprint reader on palm rest, swipe sensor, supports the security chip			
Limited warranty ¹²	1-year - EasyServ™ ¹⁹ depot repair service / service upgrades ²² available			
1GB PC2-5300 DDR2 SODIMM (TopSeller)	43R1999	T/R/W/SL Series Li-Ion Battery 6-cell	40Y6799	ThinkPlus™ ²² 1-year LOR ²⁴ 9x5 NBD
2GB PC2-5300 DDR2 SODIMM (TopSeller)	43R2000	T/R/W/SL Series Li-Ion Battery 9-cell	40Y6797	ThinkPlus 2-year LOR 9x5 NBD
SL 320GB Disk SATA 1.5Gb/s (5400 rpm)	43N3405	ThinkPad 90W AC Adapter	40Y7659	ThinkPlus 3-year LOR 9x5 NBD
USB 2.0 Ultra Secure Memory Key 8GB	45J5918	90W Slim AC/DC Combo Adapter	41N8460	ThinkPlus 3-year P&L P/U Depot
USB 2.0 Portable Secure 320GB Hard Disk	43R2019	ThinkPad Business Topload Case	43R2476	ThinkPlus 4-year P&L P/U Depot
USB 2.0 Lenovo Enhanced Port Replicator	43R8770	ThinkPad Business Backpack	43R2482	41C9172
ThinkPad Convertible Monitor Stand	40Y7620	ThinkVision® L2240p Wide 22" Monitor	4422HB6	ThinkPlus 2-year P&L P/U Depot
Laser Tilt Wheel Travel Mouse (Bluetooth)	41U5008	ThinkVision L2440x Wide 24" Monitor	4421HB2	ThinkPlus 3-year P&L P/U Depot
Other accessories on O-SL400 sheet		Other accessories at lenovo.com/accessories		ThinkPlus 4-year LOR 9x5 NBD

90-watt (NVIDIA graphics) AC adapter
 EPEAT™ Silver rating
 ENERGY STAR® 4.0-compliant
 RoHS-compliant
 International Warranty Service¹⁷
 24 hour x 7 day¹⁸ toll-free support during the warranty period¹² via 800-426-7378
 ThinkPlus™²² 1-year LOR²⁴ 9x5 NBD
 41C9166
 ThinkPlus 2-year LOR 9x5 NBD
 41C9167
 ThinkPlus 3-year LOR 9x5 NBD
 41C9168
 ThinkPlus 4-year LOR 9x5 NBD
 41C9171
 ThinkPlus 2-year P&L P/U Depot
 41C9169
 ThinkPlus 3-year P&L P/U Depot
 41N8460
 ThinkPlus 4-year P&L P/U Depot
 41C9170
 ThinkPlus 4-year P&L P/U Depot
 41C9172
 Post-warranty annual maintenance agreements at
lenovo.com/thinkplus/warranty

See footnotes for important warranty information

⊕ Intel Centrino® 2 processor technology

© Lenovo

⊗ US models announced July 29, 2008; previous models on July 15, 2008

(CAY1-2) August 2008

⊗ US models withdrawn effective September 2008

Partial list of accessories supported on:

- ThinkPad SL400 originally announced on July 15, 2008

Memory

512MB PC2-5300 DDR2 SODIMM	40Y7733	ann 01/05/06
1GB PC2-5300 DDR2 SODIMM (TopSeller)	43R1999	ann 03/25/08
1GB PC2-5300 DDR2 SODIMM	40Y7734	ann 01/05/06
2GB PC2-5300 DDR2 SODIMM (TopSeller)	43R2000	ann 03/25/08
2GB PC2-5300 DDR2 SODIMM	40Y7735	ann 11/28/06

Storage and removable storage

SL 320GB Disk SATA 1.5Gb/s (5400 rpm)	43N3405	ann 07/15/08
USB 2.0 Essential Memory Key 2GB	41U4944	ann 01/23/07
USB 2.0 Essential Memory Key 4GB	45J7904	ann 06/24/08
USB 2.0 Essential Memory Key 8GB	45J7905	ann 07/15/08
USB 2.0 Essential Memory Key 32GB	45K1258	ann 10/28/08
USB 2.0 Security Memory Key 2GB	41U5119	ann 07/17/07
USB 2.0 Security Memory Key 4GB	41U5120	ann 07/17/07
USB 2.0 Ultra Secure Memory Key 1GB	45J5915	ann 08/26/08
USB 2.0 Ultra Secure Memory Key 2GB	45J5916	ann 08/26/08
USB 2.0 Ultra Secure Memory Key 4GB	45J5917	ann 08/26/08
USB 2.0 Ultra Secure Memory Key 8GB	45J5918	ann 08/26/08
USB Portable Diskette Drive	05K9276	ann 06/05/00
USB 2.0 CD-RW/DVD-ROM Combo II Drive	40Y8637	ann 01/05/06
USB 2.0 Portable 160GB Hard Disk	43R1784	ann 09/23/08
USB 2.0 Portable Secure 160GB Hard Disk	43R2018	ann 11/18/08
USB 2.0 Portable Secure 320GB Hard Disk	43R2019	ann 11/18/08
USB 2.0 Super Multi-Burner Drive	41N5565	ann 01/23/07

Wireless WAN (Mini PCI Express)

Only WWAN upgradable models:

AT&T WWAN HSPA Broadband Mini PCIe	43R9152	ann 08/26/08
------------------------------------	---------	--------------

ThinkPad Expansion

USB 2.0 Lenovo Enhanced Port Replicator	43R8770	ann 02/26/08
ThinkPad Adjustable Notebook Stand	40Y7676	ann 09/20/05

Keyboard

TrackPoint Cap Collection	73P2698	ann 12/16/03
USB Numeric Keypad	33L3225	ann 05/01/00
Preferred Pro USB Keyboard	73P5220	ann 06/21/05
Enhanced Performance USB Keyboard	73P2620	ann 03/23/04
Wireless Kybd & Opt Wheel Mouse (via USB)	73P4067	ann 12/07/04
USB Keyboard with UltraNav	31P8950	ann 01/28/03
USB Travel Keyboard with UltraNav	31P9490	ann 04/27/04
Preferred Pro USB Fingerprint Keyboard	73P4730	ann 02/22/05

Mouse

Optical Wheel Mouse (USB)	06P4069	ann 05/21/03
Optical ScrollPoint® Mouse (USB, PS/2)	31P7405	ann 08/27/02
Optical Wheel Travel Mouse (USB, PS/2)	31P7410	ann 06/04/02
Laser Tilt Wheel Mouse (USB, PS/2)	41U3074	ann 01/23/07
Lenovo Wireless Laser Mouse (blk, via USB)	45K1696	ann 11/25/08
Lenovo Wireless Laser Mouse (red, via USB)	51J0198	ann 11/25/08
Laser Tilt Wheel Travel Mouse (Bluetooth)	41U5008	ann 01/22/08

Security

Kensington® Cable Lock from Lenovo	73P2582	ann 12/29/03
Kensington Twin Head Cable Lock	45K1620	ann 09/30/08
USB Gemplus GemPC Smart Card Reader	41N3040	ann 02/21/06
ExpressCard Gemplus Smart Card Reader ⁴⁷	41N3043	ann 06/27/06

⁴⁷ Requires ExpressCard slot

Multimedia

USB 2.0 Lenovo Multimedia Headset	40Y8518	ann 06/27/06
USB 2.0 Lenovo Webcam	40Y8519	ann 08/29/06

Batteries

T/R/W/SL Series Li-Ion Battery 6-cell	40Y6799	ann 01/05/06
T/R/W/SL Series Li-Ion Battery 9-cell	40Y6797	ann 09/20/05
ThinkPad External Battery Charger ⁴⁴	40Y7625	ann 09/20/05

⁴⁴ Requires the *ThinkPad 90W AC Adapter*

40Y7659 (adapter provided with some systems).

More information at www.lenovo.com/alldaycomputing

ThinkPad 65W AC Adapter ⁴⁵	40Y7696	
⁴⁵ Only compatible with the GM45 chipset models.		
ThinkPad 90W AC Adapter	40Y7659	ann 09/20/05
ThinkPad 90W Slim AC/DC Combo Adapter	41N8460	ann 11/27/07

More info at www.lenovo.com/support/poweradapters

Charging tips for 90W Slim AC/DC Combo Adapter 41N8460

•Dual (ThinkPad+Phone) Charging Y-Cable	41R4345	ann 12/18/07
•Palm device charge tip (L7)	41R4315	ann 12/18/07
•Blackberry charge tip (L8a)	41R4478	ann 12/18/07
•Ipod and Iphone charge tip (L10a)	41R4481	ann 12/18/07

More information at www.lenovo.com/support/slimadaptertips

Carrying Cases

Up to 14.1" widescreen models:

ThinkPad Expander Case	43R9118	ann 06/24/08
ThinkPad Women's Microfiber Tote	22P8855	
ThinkPad Women's Leather Trim Tote	22P8856	
ThinkPad Convertible Carrying Case	22P8860	
ThinkPad Women's Executive Leather Tote	22P8857	
Women's Executive Red Leather Tote	22P8858	

Up to 15.4" widescreen models:

Lenovo Carrying Case - Messenger Max	41U5253	ann 05/01/07
Lenovo Carr Case - Performance Backpack	41U5254	ann 05/01/07
Lenovo Standard Case	45K1697	ann 11/25/08
Lenovo Standard Backpack	45K1698	ann 11/25/08
ThinkPad Business Topload Case	43R2476	ann 05/13/08
ThinkPad Business Backpack	43R2482	ann 05/13/08
ThinkPad Deluxe Expander Case	43R2478	ann 05/13/08
ThinkPad Executive Leather Case	43R2480	ann 05/13/08

Up to 17.0" widescreen models:

ThinkPad 17W Business Topload Case	43R9117	ann 08/12/08
------------------------------------	---------	--------------

Lenovo luxury cases at www.lenovoluxurycases.com

Monitors

ThinkVision® L174 17" Monitor	9227AE1	ann 04/15/08
ThinkVision L1700p 17" Monitor	9417HE2	ann 09/17/08
ThinkVision L1900p 19" Monitor	4431HE1	ann 11/11/08
ThinkVision L1940p Wide 19" Monitor	4424HB6	ann 09/17/08
ThinkVision L200p Wide 20.1" Monitor	4438HB6	ann 04/15/08
ThinkVision L2240p Wide 22" Monitor	4422HB6	ann 09/17/08
ThinkVision L2440p Wide 24" Monitor	4420HB2	ann 09/17/08
ThinkVision L2440x Wide 24" Monitor	4421HB2	ann 09/17/08

Monitor Accessories⁴⁶

ThinkVision USB Soundbar	40Y7616	ann 08/23/05
ThinkVision Soundbar	45K1263	ann 09/16/08
Kensington Cable Lock from Lenovo	73P2582	ann 12/29/03
Kensington Twin Head Cable Lock	45K1620	ann 09/30/08
ThinkPad Convertible Monitor Stand	40Y7620	ann 01/05/06
Radial Arm	19K4464	ann 05/05/00

⁴⁶ Compatible on selected Lenovo and ThinkVision monitors.

More information at www.lenovo.com/support/monitoraccessories

Other accessories at www.lenovo.com/accessories

Accessories Guide pdf at www.lenovo.com/accessoriesguide

ThinkPad®



Lenovo ThinkPad SL500



Lenovo ThinkPad SL500



Lenovo ThinkPad SL500



Lenovo ThinkPad SL500



Lenovo ThinkPad SL500



Lenovo ThinkPad SL500

ThinkPad® SL500 2746 (GMA) - TopSeller (Celeron)

Personal Systems Reference (PSREF)

Type-model	Celeron processor	GHz	Memory	Wide-screen display	Screen type	Camera	Integrated graphics	Disk SATA GB ⁸ rpm	SATA optical	Mini PCIe 802.11 wireless	Mini PCIe WWAN	Mini PCIe UWB or Turbo	Battery / Preload	Availability
2746-8XU	Cel 585	2.16	1GB	15.4" WXGA	Glossy	None	GMA 80G	5400	DVD±RW	11b/g ³²	WWAN upg	None	No	Home B Aug 08
2746-8YU	Cel 585	2.16	1GB	15.4" WXGA		None	GMA 160G	5400	DVD±RW	11b/g	WWAN upg	None	No	XP Pro Aug 08
2746-BKU	Cel T1600	1.66	1GB	15.4" WXGA		None	GMA 160G	5400	DVD±RW	11b/g	WWAN upg	None	No	XP Pro Sep 08
2746-9VU	Cel T1600	1.66	1GB	15.4" WXGA		None	GMA 160G	5400	DVD±RW	11b/g	WWAN upg	None	No	Home B Dec 08

- These small and medium business (SMB) models are part of the US TopSeller™ Program
- A comprehensive computing solution for small and medium business
- Balanced between serious business computing and powerful multimedia features

Processor	Intel® Celeron® Processor 585 with single-core, 667MHz system bus, and 1MB L2 cache or Intel Celeron Processor T1600 with dual-core, 667MHz system bus, and 1MB L2 cache										Preloaded operating system ²⁰ - Some: Microsoft® Windows® XP Professional with Vista® COA							
Memory	1GB std / 4GB max ⁷ / PC2-5300 667MHz DDR2, non-parity, dual-channel capable, two 200-pin SO-DIMM sockets; Non-italics: standard memory in one socket; one socket available										- Some: Microsoft Windows Vista Home Basic Edition (32-bit) ◇ Vista Basic logo							
SATA DVD±RW SATA disk	Some: DVD burner, SATA 1.5Gb/s, 12.7mm high, fixed, not removable, tray-in 80GB ⁸ (5400 rpm) or 160GB ⁸ (5400 rpm) / SATA 1.5Gb/s, 9.5mm high, removable, upgradable, ThinkPad Shock Mounted Hard Drive, Active Protection System™										Preloaded applications ¹⁴ (all OSes) • Lenovo Care™ Tools • Rescue and Recovery™ • Access Connections™ • Password Manager • System Update • McAfee VirusScan® Plus with SiteAdvisor™ (30 days of virus definitions) • PC-Doctor™ (diagnostics) • ThinkPad Utilities (Power Manager and Presentation Director) • Adobe® Reader • Windows Live™ Toolbar • Windows Live Search • Fingerprint Software • Microsoft Office 2007 Trial (60-day) • Roxio® Creator® Small Business Edition • Roxio MyDVD® (DVD±RW)							
Widescreen display	Some: 15.4" (391.2mm) WXGA (1280x800) color, anti-glare, CCFL backlight, 200 nits, 16:10 aspect ratio, 300:1 contrast ratio Some: 15.4" (391.2mm) WXGA (1280x800) color, VibrantView (glossy), CCFL backlight, 200 nits, 16:10 aspect ratio, 300:1 contrast ratio																	
Camera	None																	
Integrated graphics	Intel Graphics Media Accelerator 4500M (GMA 4500M), in GL40, HDMI port supporting HDCP to output protected content Max external resolution: 2048x1536@75Hz (VGA DB-15 port); 1920x1080 (HDMI port)																	
Keyboard TrackPoint® Touch pad Lighting FX	6-row, Lenovo Care button, spill-resistant, multimedia Fn keys, Windows/Appl keys TrackPoint® pointing device, Internet Scroll Bar ¹³ , magnifying glass UltraNav™, wide touch pad below keyboard, Tap Zones, scrolling regions label Illuminated power button, Lenovo Care button, and red dot on ThinkPad logo																	
Dimensions ³ Weight ² Case color Case material Battery - type Battery - life ¹⁰	6-cell 15.4W ⁹ (WxDxH): 14.1" x 10.2" x 1.46–1.53"; 358 x 260mm x 37–39mm 6-cell: starting at 6.3 lb (2.9kg) Black Scratch-resistant ABS plastic, high-gloss top cover Lithium Ion 6-cell 6-cell: up to 3.6 hr; 9-cell: up to 5.5 hr																	
Chipset	Mobile Intel GL40 Express Chipset (Graphics Memory Controller Hub), ICH9M I/O Controller Hub (SATA 3.0Gb/s, USB 2.0, PCI Express® 1.1, PCI 2.3, security chip, ethernet MAC), LPC bus (IT8752 Super I/O)																	
ExpressCard/54 Multicard reader PC Card Smart Card read Ports	One slot (ExpressCard/34, ExpressCard/54) 7-in-1 reader (MMC, Memory Stick, Mem Stick Pro, SD, SDHC, XD, XD Type H) None None Four USB 2.0, external monitor (VGA DB-15, HDMI), modem (RJ-11), ethernet (RJ-45), IEEE 1394 FireWire 400 (4-pin connector; 1394a-2000 standard)																	
Mini PCI Express 11b/g ³² WWAN upg 2G Turbo UWB Modem Bluetooth™ Ethernet Intel AMT Audio support	Three Mini PCI Express slots 11b/g wireless ⁴ , ThinkPad 11b/g Mini PCIe Adapter III, Atheros AR5007EG Wireless WAN upgradable, optional AT&T® (43R9152) None None 56K V.92 ⁶ modem None Realtek® RTL8111C Gigabit Network Connection, PHY, PCIe x1 None High Definition (HD) Audio, CX20561-15Z codec / stereo speakers, 2 watt / volume up, down, mute buttons / dual array microphone, mic input jack, headphone jack										65-watt (GMA graphics) AC adapter EPEAT™ Silver rating RoHS-compliant International Warranty Service ¹⁷ 24 hour x 7 day ¹⁸ toll-free support during the warranty period ¹² via 800-426-7378							
Security Security chip Fingerprint reader	Power-on password, hard disk password, supervisor password, security keyhole None None										ThinkPlus™.22 1-year LOR ²⁴ 9x5 NBD 41C9166 ThinkPlus 2-year LOR 9x5 NBD 41C9167 ThinkPlus 3-year LOR 9x5 NBD 41C9168							
Limited warranty ¹²	1-year - EasyServ™.19 depot repair service / service upgrades ²² available										ThinkPlus 4-year LOR 9x5 NBD 41C9171 ThinkPlus 2-year P&L P/U Depot 41C9169 ThinkPlus 3-year P&L P/U Depot 41C9170 ThinkPlus 4-year P&L P/U Depot 41C9172							
	1GB PC2-5300 DDR2 SODIMM (TopSeller) 43R1999 2GB PC2-5300 DDR2 SODIMM (TopSeller) 43R2000 SL 320GB Disk SATA 1.5Gb/s (5400 rpm) 43N3405 USB 2.0 Ultra Secure Memory Key 8GB 45J5918 USB 2.0 Lenovo Webcam 40Y8519 USB 2.0 Portable Secure 320GB Hard Disk 43R2019 USB 2.0 Lenovo Enhanced Port Replicator 43R8770 ThinkPad Convertible Monitor Stand 40Y7620 Laser Tilt Wheel Travel Mouse (Bluetooth) 41U5008 Other accessories on O-SL500 sheet										T/R/W/SL Series Li-Ion Battery 6-cell 40Y6799 T/R/W/SL Series Li-Ion Battery 9-cell 40Y6797 ThinkPad 90W AC Adapter 40Y7659 90W Slim AC/DC Combo Adapter 41N8460 ThinkPad Business Topload Case 43R2476 ThinkPad Business Backpack 43R2482 ThinkVision® L1940p Wide 19" Monitor 4424HB6 ThinkVision L2240p Wide 22" Monitor 4422HB6 ThinkVision L2440x Wide 24" Monitor 4421HB2 Other accessories at lenovo.com/accessories				Post-warranty agreements at lenovo.com/thinkplus/warranty			

See footnotes for important warranty information

US model announced December 16, 2008; previous models on August 20 or September 30, 2008

© Lenovo
(TAR1-3) January 2009

ThinkPad® SL500 2746 (GMA) - TopSeller

Personal Systems Reference (PSREF)

Type-model	Proc- essor GHz	Memory	Wide- screen display	Screen type	Cam- era	Inte- grated graphics	Disk SATA GB ⁸ rpm	SATA optical	Mini PCIe 802.11 wireless	Mini PCIe WWAN	Mini PCIe UWB or Turbo	Finger print Blue- tooth	Bat- tery cells Preload	Avail date
2746-3UU	T5670	1.80	2GB	15.4"	WXGA		GMA 250G 5400 DVD±RW	* Intel 5100 ²⁸	AT&T ²³			Fing	6 Bus 32	July 08
2746-3VU	T5670	1.80	2GB	15.4"	WXGA	Glossy Cam	GMA 250G 5400 DVD±RW	* Intel 5100	AT&T			Fing Blue	6 Home P	July 08
2746-3WU	T5670	1.80	2GB	15.4"	WXGA	Cam	GMA 160G 5400 DVD±RW	* Intel 5100	AT&T			Fing Blue	6 Bus 32	July 08
2746-3XU	T5670	1.80	2GB	15.4"	WXGA		GMA 250G 5400 DVD±RW	* Intel 5100	WWAN upg			Fing	6 Bus 32	July 08
2746-3YU	T5670	1.80	2GB	15.4"	WXGA	Glossy Cam	GMA 250G 5400 DVD±RW	* Intel 5100	WWAN upg			Fing Blue	6 Home P	July 08
2746-3ZU	T5670	1.80	2GB	15.4"	WXGA	Cam	GMA 160G 5400 DVD±RW	* Intel 5100	WWAN upg			Fing Blue	6 Bus 32	July 08
2746-3NU	P8400	2.26	1GB	15.4"	WXGA		GMA 160G 5400 Combo	Intel 5100	AT&T			Fing	6 Bus 32	July 08
2746-3PU	P8400	2.26	2GB	15.4"	WXGA		GMA 160G 5400 DVD±RW	Intel 5100	AT&T			Fing	6 Bus 32	July 08
2746-3RU	P8400	2.26	1GB	15.4"	WXGA		GMA 160G 5400 Combo	Intel 5100	WWAN upg			Fing	6 Bus 32	July 08
2746-3SU	P8400	2.26	2GB	15.4"	WXGA		GMA 160G 5400 DVD±RW	Intel 5100	WWAN upg			Fing	6 Bus 32	July 08
2746-23U	P8600	2.40	2GB	15.4"	WXGA	Cam	GMA 250G 5400 DVD±RW	Intel 5100	AT&T			Fing Blue	6 Bus 32	July 08
2746-26U	P8600	2.40	2GB	15.4"	WXGA	Cam	GMA 160G 5400 DVD±RW	Intel 5100	WWAN upg	2GB Turbo		Fing Blue	6 Bus 32	July 08
2746-6VU	P8400	2.26	2GB	15.4"	WXGA		GMA 160G 5400 DVD±RW	Intel 5100	AT&T			Fing	6 XP Pro	Aug 08
2746-6XU	P8400	2.26	2GB	15.4"	WXGA		GMA 160G 5400 DVD±RW	Intel 5100	WWAN upg			Fing	6 XP Pro	Aug 08
2746-6ZU	T5670	1.80	2GB	15.4"	WXGA		GMA 250G 5400 DVD±RW	* Intel 5100	WWAN upg			Fing	6 XP Pro	Aug 08
2746-72U	T5670	1.80	2GB	15.4"	WXGA	Cam	GMA 160G 5400 DVD±RW	* Intel 5100	WWAN upg			Fing Blue	6 XP Pro	Aug 08
2746-73U	T5670	1.80	1GB	15.4"	WXGA		GMA 160G 5400 DVD±RW	* Intel 5100	WWAN upg			Fing	6 XP Pro	Aug 08
2746-7DU	P8600	2.40	2GB	15.4"	WXGA	Cam	GMA 160G 5400 DVD±RW	Intel 5100	WWAN upg			Fing Blue	6 XP Pro	Aug 08

• These small and medium business (SMB) models are part of the US TopSeller™ Program

Processor	Intel® Core™ 2 Duo processor T5670 with dual-core, 800MHz system bus, and 2MB L2 cache or Intel Core 2 Duo processor P8400 or P8600 with dual-core, Intel HD boost, 1066MHz system bus, and 3MB L2 cache	Preloaded operating system ²⁰ - Some: Microsoft® Windows® XP Professional with Vista® COA - Some: Microsoft® Windows® Vista® Home Premium Ed (32-bit) - Some: Microsoft Windows Vista Business Edition (32-bit) ◇ 1GB Vista/XP Pro models: Vista Basic logo ◇ 2GB models: Vista Premium logo
Memory	1GB or 2GB std / 4GB max ⁷ / PC2-5300 667MHz DDR2, non-parity, dual-channel capable, two 200-pin SO-DIMM sockets; <i>Italics:</i> standard memory in both sockets; no sockets available; <i>Non-italics:</i> standard memory in one socket; one socket available	Preloaded applications ¹⁴ (all OSes) • Lenovo Care™ Tools • Rescue and Recovery™ • Access Connections™ • Password Manager • System Update • McAfee VirusScan® Plus with SiteAdvisor™ (30 days of virus definitions) • PC-Doctor™ (diagnostics) • ThinkPad Utilities (Power Manager and Presentation Director) • Adobe® Reader • Windows Live™ Toolbar • Windows Live Search • FingerPrint Software • Microsoft Office 2007 Trial (60-day) • Roxio® Creator® Small Business Edition • Roxio MyDVD® (DVD±RW)
SATA Combo SATA DVD±RW SATA disk	Some: DVD-ROM/CD-RW, SATA 1.5Gb/s, 12.7mm high, fixed, not removable, tray-in Some: DVD burner, SATA 1.5Gb/s, 12.7mm high, fixed, not removable, tray-in 160GB ⁸ (5400 rpm) or 250GB (5400 rpm) / SATA 1.5Gb/s, 9.5mm high, removable, upgradable, ThinkPad Shock Mounted Hard Drive, Active Protection System™	
Widescreen display	Some: 15.4" (391.2mm) WXGA (1280x800) color, anti-glare, CCFL backlight, 200 nits, 16:10 aspect ratio, 300:1 contrast ratio Some: 15.4" (391.2mm) WXGA (1280x800) color, VibrantView (glossy), CCFL backlight, 200 nits, 16:10 aspect ratio, 300:1 contrast ratio	
Camera	Some: camera on top of screen, 2.0-megapixel, fixed focus	
Integrated graphics	Intel Graphics Media Accelerator 4500MHD (GMA 4500MHD), in GM45, HDMI port supporting HDCP to output protected content Max external resolution: 2048x1536@75Hz (DB-15 port); 1920x1080 (HDMI port)	
Keyboard TrackPoint® Touch pad Lighting FX	6-row, Lenovo Care button, spill-resistant, multimedia Fn keys TrackPoint® pointing device, Internet Scroll Bar ¹³ , magnifying glass UltraNav™, wide touch pad below keyboard, Tap Zones, scrolling regions label Illuminated power button, Lenovo Care button, and red dot on ThinkPad logo	
Dimensions ³ Weight ² Case Battery - type Battery - life ¹⁰	6-cell 15.4W" (WxDxH): 14.1" x 10.2" x 1.46–1.53"; 358 x 260mm x 37–39mm 6-cell: starting at 6.3 lb (2.9kg) Color: black; Material: scratch-resistant ABS plastic, high-gloss top cover Lithium Ion 6-cell 6-cell: up to 3.6 hr; 9-cell: up to 5.5 hr	
Chipset	Mobile Intel GM45 Express Chipset (Graphics Memory Controller Hub), ICH9M I/O Controller Hub (SATA 3.0Gb/s, USB 2.0, PCI Express® 1.1, PCI 2.3, security chip, ethernet MAC), LPC bus (IT8752 Super I/O)	
ExpressCard slot Multicard Reader PC Card Std slot Smart Card Read Ports	One ExpressCard/34 or ExpressCard/54 7-in-1 reader (MMC, Memory Stick, Mem Stick Pro, SD, SDHC, XD, XD Type H) None None Four USB 2.0, external monitor (VGA DB-15, HDMI), modem (RJ-11), ethernet (RJ-45), IEEE 1394 FireWire 400 (4-pin connector; 1394a-2000 standard)	65-watt (GMA graphics) AC adapter EPEAT™ Silver rating ENERGY STAR® 4.0-compliant RoHS-compliant International Warranty Service ¹⁷ 24 hour x 7 day ¹⁸ toll-free support during the warranty period ¹² via 800-426-7378
Mini PCI Express Intel 5100 ²⁸ WWAN upg AT&T ²³ 2G Turbo UWB Modem Bluetooth™ Ethernet Intel AMT Audio support	Three Mini PCI Express slots 11a/b/g/n wireless ⁴ , Mini PCIe adapter, Intel WiFi Link 5100, 1x2 (Shirley Peak) Some: Wireless WAN upgradable, optional AT&T® (43R9152) Some: Wireless WAN, Ericsson chipset, Mini PCIe adapter and SIM, GPRS/WCDMA/HSPA, GPS, service contract required with AT&T® Some: Intel Turbo Memory, Half-Mini PCIe adapter, 2GB flash, disk-cache accelerator None 56K V.92 ⁶ modem Some: Bluetooth 2.0 wireless, LED indicator Realtek RTL8111C Gigabit Network Connection, PHY, PCIe x1 None High Definition (HD) Audio, CX20561-15Z codec / stereo speakers, 2 watt / volume up, down, mute buttons / dual array microphone, mic input jack, headphone jack	ThinkPlus™.22 1-year LOR ²⁴ 9x5 NBD 41C9166 ThinkPlus 2-year LOR 9x5 NBD 41C9167 ThinkPlus 3-year LOR 9x5 NBD 41C9168 ThinkPlus 4-year LOR 9x5 NBD 41C9171 ThinkPlus 2-year P&L P/U Depot 41C9169 ThinkPlus 3-year P&L P/U Depot 41C9170 ThinkPlus 4-year P&L P/U Depot 41C9172
Security Security chip Fingerprint reader	Power-on password, hard disk password, supervisor password, security keyhole None Some: Fingerprint reader on palm rest, swipe sensor, supports the security chip	Post-warranty agreements at lenovo.com/thinkplus/warranty
Limited warranty ¹²	1-year - EasyServ™.19 depot repair service / service upgrades ²² available	

See footnotes for important warranty information
US models announced July 15 or 29, 2008

* Intel Centrino® processor technology
✦ Intel Centrino® 2 processor technology

© Lenovo
(TAR1-1) August 2008

✦ US models withdrawn effective September 2008 or January 2009

ThinkPad® SL500 2746 (GMA) - TopSeller (September 2008)

Personal Systems Reference (PSREF)

Type-model	Proc- essor	GHz	Memory	Wide- screen display	Screen type	Cam- era	Inte- grated graphics	Disk SATA GB ⁸ rpm	SATA optical	Mini PCIe 802.11 wireless	Mini PCIe WWAN	Mini PCIe UWB or Turbo	Finger print reader	Blue- tooth	Bat- tery cells	Pre- load	Avail date
2746-6DU	T5670	1.80	1GB	15.4"	WXGA		GMA	80GB 5400	DVD±RW	* Intel 5100 ²⁸	WWAN upg	None	None	Fing	6	XP Pro	Sep08
2746-6EU	P7370	2.00	2GB	15.4"	WXGA		GMA	250G 5400	DVD±RW	† Intel 5100	WWAN upg	None	Fing	Blue	6	XP Pro	Sep08
2746-6JU	T5870	2.00	2GB	15.4"	WXGA	Cam	GMA	250G 5400	DVD±RW	* Intel 5100	WWAN upg	None	Fing	Blue	6	XP Pro	Oct 08
2746-9LU	P7370	2.00	3GB	15.4"	WXGA	Cam	GMA	250G 5400	DVD±RW	† Intel 5100	WWAN upg	None	Fing	Blue	6	XP Pro	Nov08
2746-9MU	T5870	2.00	1GB	15.4"	WXGA		GMA	160G 5400	DVD±RW	* Intel 5100	WWAN upg	None	None	None	6	XP Pro	Dec08
2746-9NU	T5870	2.00	2GB	15.4"	WXGA		GMA	250G 5400	DVD±RW	* Intel 5100	WWAN upg	None	Fing	None	6	XP Pro	Dec08
2746-9PU	T5870	2.00	2GB	15.4"	WXGA		GMA	250G 5400	DVD±RW	* Intel 5100	WWAN upg	None	Fing	None	6	Bus 32	Dec08
2746-9QU	T5870	2.00	3GB	15.4"	WXGA	Glossy Cam	GMA	250G 5400	DVD±RW	* Intel 5100	WWAN upg	None	None	Blue	6	Home P	Dec08
2746-ASU	P8600	2.40	2GB	15.4"	WXGA	Cam	GMA	250G 5400	DVD±RW	† Intel 5100	WWAN upg	None	Fing	None	6	Bus 32	Dec08
2746-H2U	P8600	2.40	2GB	15.4"	WXGA		GMA	160G 5400	DVD±RW	† WiMAX	WWAN upg	None	Fing	None	6	Bus 32	Jan 09
2746-H3U	P8600	2.40	3GB	15.4"	WXGA	Cam	GMA	160G 5400	DVD±RW	† Intel 5100	WWAN upg	None	Fing	Blue	6	XP Pro	Jan 09

- These small and medium business (SMB) models are part of the US TopSeller™ Program
- A comprehensive computing solution for small and medium business

Processor	Intel® Core™ 2 Duo processor T5670 or T5870 with dual-core, 800MHz system bus, and 2MB L2 cache or Intel Core 2 Duo processor P7370 or P8600 with dual-core, Intel HD boost, 1066MHz system bus, and 3MB L2 cache											Preloaded operating system ²⁰ - Some: Microsoft® Windows® XP Professional with Vista® COA					
Memory	1GB, 2GB, or 3GB std / 4GB max ⁷ / PC2-5300 667MHz DDR2, non-parity, dual-channel capable, two 200-pin SO-DIMM sockets; <i>Italics:</i> standard memory in both sockets; no sockets available; <i>Non-italics:</i> standard memory in one socket; one socket available											- Some: Microsoft Windows Vista Home Premium Edition (32-bit) - Some: Microsoft Windows Vista Business Edition (32-bit) ◇ ASU model: Vista Premium logo ◇ Other models: Vista Basic logo					
SATA DVD±RW SATA disk	DVD burner, SATA 1.5Gb/s, 12.7mm high, fixed, not removable, tray-in 80GB ⁸ (5400 rpm), 160GB (5400 rpm), or 250GB (5400 rpm) / SATA 1.5Gb/s, 9.5mm high, removable, upgradable, ThinkPad Shock Mounted Hard Drive, Active Protection System™											Preloaded applications ¹⁴ (all OSes) • Lenovo Care™ Tools • Rescue and Recovery™ • Access Connections™ • Password Manager • System Update • McAfee VirusScan® Plus with SiteAdvisor™ (30 days of virus definitions) • PC-Doctor™ (diagnostics) • ThinkPad Utilities (Power Manager and Presentation Director) • Adobe® Reader • Windows Live™ Toolbar • Windows Live Search • Windows Live Mail (model ASU) • Windows Live Messenger (model ASU) • Windows Live Photo Gallery (model ASU) • FingerPrint Software • Microsoft Office 2007 Trial (60-day) • Roxio® Creator® Small Business Edition • Roxio MyDVD® (DVD±RW)					
Widescreen display	Some: 15.4" (391.2mm) WXGA (1280x800) color, VibrantView (glossy), CCFL backlight, 200 nits, 16:10 aspect ratio, 300:1 contrast ratio Some: 15.4" (391.2mm) WXGA (1280x800) color, anti-glare, CCFL backlight, 200 nits, 16:10 aspect ratio, 300:1 contrast ratio											65-watt (GMA graphics) AC adapter EPEAT™ Silver rating ENERGY STAR® 4.0-compliant RoHS-compliant International Warranty Service ¹⁷ 24 hour x 7 day ¹⁸ toll-free support during the warranty period ¹² via 800-426-7378					
Camera	Some: camera on top of screen, 2.0-megapixel, fixed focus																
Integrated graphics	Intel Graphics Media Accelerator 4500MHD (GMA 4500MHD), in GM45, HDMI port supporting HDCP to output protected content Max external resolution: 2048x1536@75Hz (VGA DB-15); 1920x1080 (HDMI)											ThinkPlus™.22 1-year LOR ²⁴ 9x5 NBD 41C9166 ThinkPlus 2-year LOR 9x5 NBD 41C9167 ThinkPlus 3-year LOR 9x5 NBD 41C9168 ThinkPlus 4-year LOR 9x5 NBD 41C9171 ThinkPlus 2-year P&L P/U Depot 41C9169 ThinkPlus 3-year P&L P/U Depot 41C9170 ThinkPlus 4-year P&L P/U Depot 41C9172 Post-warranty agreements at lenovo.com/thinkplus/warranty					
Keyboard TrackPoint® Touch pad Lighting FX	6-row, Lenovo Care button, spill-resistant, multimedia Fn keys TrackPoint® pointing device, Internet Scroll Bar ¹³ , magnifying glass UltraNav™, wide touch pad below keyboard, Tap Zones, scrolling regions label Illuminated power button, Lenovo Care button, and red dot on ThinkPad logo																
Dimensions ³ Weight ² Case color Case material Battery - type Battery - life ¹⁰	6-cell 15.4W" (WxDxH): 14.1" x 10.2" x 1.46–1.53"; 358 x 260mm x 37–39mm 6-cell: starting at 6.3 lb (2.9kg) Black Scratch-resistant ABS plastic, high-gloss top cover Lithium Ion 6-cell 6-cell: up to 3.6 hr; 9-cell: up to 5.5 hr											ThinkPlus 4-year LOR 9x5 NBD 41C9171 ThinkPlus 2-year P&L P/U Depot 41C9169 ThinkPlus 3-year P&L P/U Depot 41C9170 ThinkPlus 4-year P&L P/U Depot 41C9172 Post-warranty agreements at lenovo.com/thinkplus/warranty					
Chipset	Mobile Intel GM45 Express Chipset (Graphics Memory Controller Hub), ICH9M I/O Controller Hub (SATA 3.0Gb/s, USB 2.0, PCI Express® 1.1, PCI 2.3, security chip, ethernet MAC), LPC bus (IT8752 Super I/O)																
ExpressCard/54 Multicard reader PC Card Smart Card read Ports	One slot (ExpressCard/34, ExpressCard/54) 7-in-1 reader (MMC, Memory Stick, Mem Stick PRO™, SD, SDHC, XD, XD Type H) None None Four USB 2.0, external monitor (VGA DB-15, HDMI), modem (RJ-11), ethernet (RJ-45), IEEE 1394 FireWire 400 (4-pin connector; 1394a-2000 standard)											ThinkPlus 3-year P&L P/U Depot 41C9169 ThinkPlus 4-year P&L P/U Depot 41C9170 ThinkPlus 4-year P&L P/U Depot 41C9172 Post-warranty agreements at lenovo.com/thinkplus/warranty					
Mini PCI Express Intel 5100 ²⁸ WiMAX	Three Mini PCI Express slots Some: 11a/b/g/n wireless ⁴ , Mini PCIe adapter, Intel WiFi Link 5100, 1x2 (Shirley Peak) Some: 11a/b/g/n and WiMAX wireless ⁴ , Mini PCIe adap, Intel WiMAX/WiFi Link 5150, 1x2 (300Mbps) WiFi + 1x2 WiMAX (Echo Peak)																
WWAN upg 2G Turbo UWB	Wireless WAN upgradable, optional AT&T® (43R9152) None None											ThinkPlus 4-year LOR 9x5 NBD 41C9171 ThinkPlus 2-year P&L P/U Depot 41C9169 ThinkPlus 3-year P&L P/U Depot 41C9170 ThinkPlus 4-year P&L P/U Depot 41C9172 Post-warranty agreements at lenovo.com/thinkplus/warranty					
Modem Bluetooth™ Ethernet Intel AMT	56K V.92 ⁶ modem Some: Bluetooth 2.0 wireless, LED indicator Realtek® RTL8111C Gigabit Network Connection, PHY, PCIe x1 None																
Audio support	High Definition (HD) Audio, CX20561-15Z codec / stereo speakers, 2 watt / volume up, down, mute buttons / dual array microphone, mic input jack, headphone jack											ThinkPlus 4-year LOR 9x5 NBD 41C9171 ThinkPlus 2-year P&L P/U Depot 41C9169 ThinkPlus 3-year P&L P/U Depot 41C9170 ThinkPlus 4-year P&L P/U Depot 41C9172 Post-warranty agreements at lenovo.com/thinkplus/warranty					
Security Security chip Fingerprint reader	Power-on password, hard disk password, supervisor password, security keyhole None Some: Fingerprint reader on palm rest, swipe sensor, supports the security chip																
Limited warranty ¹²	1-year - EasyServ™.19 depot repair service / service upgrades ²² available											ThinkPlus 4-year LOR 9x5 NBD 41C9172 Post-warranty agreements at lenovo.com/thinkplus/warranty					
	1GB PC2-5300 DDR2 SODIMM (TopSeller) 43R1999 2GB PC2-5300 DDR2 SODIMM (TopSeller) 43R2000 SL 320GB Disk SATA 1.5Gb/s (5400 rpm) 43N3405 USB 2.0 Portable Secure 320GB Hard Disk 43R2019 Other accessories on O-SL500 sheet																
	T/R/W/SL Series Li-Ion Battery 9-cell 40Y6797 90W Slim AC/DC Combo Adapter 41N8460 ThinkPad Business Topload Case 43R2476 ThinkVision® L2440x Wide 24" Monitor 4421HB2 Other accessories at lenovo.com/accessories																

See footnotes for important warranty information

- † US models announced Dec 16, 2008 or Jan 6, 2009; previous models on Sep 30, Oct 7, or November 25, 2008
- ‡ US models withdrawn effective January 2009

- * Intel Centrino® processor technology
- † Intel Centrino 2 processor technology

© Lenovo (TAR1-4) January 2009

ThinkPad® SL500 2746 (NVIDIA®) - TopSeller

Personal Systems Reference (PSREF)

Type-model	Processor	GHz	Memory	Wide-screen display	Screen type	Cam-DISCRETE era graphics	Disk SATA GB ⁸ rpm	SATA optical	Mini PCIe 802.11 wireless	Mini PCIe WWAN	Mini PCIe UWB or Turbo	Battery cells	Vista preload	Avail date
< 2746-3QU P8400	2.26	2GB	15.4" WSXGA+	Cam 9300M	160G 5400	DVD±RW	Intel 5100 ²⁸	AT&T ²³	6	Bus 32	July 08			
2746-3TU P8400	2.26	2GB	15.4" WSXGA+	Cam 9300M	160G 5400	DVD±RW	Intel 5100	WWAN upg	6	Bus 32	July 08			
< 2746-22U P8400	2.26	2GB	15.4" WXGA	Glossy Cam 9300M	160G 5400	DVD±RW	Intel 5100	AT&T	6	Bus 32	July 08			
2746-24U P8600	2.40	2GB	15.4" WSXGA+	Cam 9300M	320G 5400	DVD±RW	Intel 5100	AT&T	2GB Turbo	9	Bus 32	July 08		
< 2746-25U T9400	2.53	4GB	15.4" WSXGA+	Cam 9300M	320G 5400	Blu-ray™	Intel 5100	AT&T	2GB Turbo	9	Ult 32	July 08		
2746-6WU P8400	2.26	2GB	15.4" WSXGA+	Cam 9300M	160G 5400	DVD±RW	Intel 5100	AT&T	6	XP Pro	Aug 08			
2746-6YU P8400	2.26	2GB	15.4" WSXGA+	Cam 9300M	160G 5400	DVD±RW	Intel 5100	WWAN upg	6	XP Pro	Aug 08			

• These small and medium business (SMB) models are part of the US TopSeller™ Program
 • A comprehensive computing solution for small and medium business

Processor	Intel® Core™ 2 Duo processor P8400, P8600, or T9400 with dual-core, Intel HD boost, 1066MHz system bus; P8400/P8600: 3MB L2 cache; T9400: 6MB L2 cache	Preloaded operating system²⁰ - Some: Microsoft® Windows® XP Professional with Vista® COA - Some: Microsoft® Windows® Vista® Business Edition (32-bit) - Some: Microsoft Windows Vista Ultimate Edition (32-bit) ♦ XP Pro models: Vista Basic logo ♦ Vista models: Vista Premium logo Preloaded applications¹⁴ • Lenovo Care™ Tools • Rescue and Recovery™ • Access Connections™ • Password Manager • System Update • McAfee VirusScan® Plus with SiteAdvisor™ (30 days of virus definitions) • PC-Doctor™ (diagnostics) • ThinkPad Utilities (Power Manager and Presentation Director) • Adobe® Reader • Windows Live™ Toolbar • Windows Live Search • Fingerprint Software • Microsoft Office 2007 Trial (60-day) • Roxio® Creator Small Business Edition • Roxio MyDVD® (DVD±RW, Blu-ray)			
Memory	2GB or 4GB std / 4GB max ⁷ / PC2-5300 667MHz DDR2, non-parity, dual-channel capable, two 200-pin SO-DIMM sockets; <i>Italics:</i> standard memory in both sockets; no sockets available; <i>Non-italics:</i> standard memory in one socket; one socket available				
SATA DVD±RW SATA Blu-ray SATA disk	Some: DVD burner, SATA 1.5Gb/s, 12.7mm high, fixed, not removable, tray-in Some: Blu-ray burner, SATA 1.5Gb/s, 12.7mm high, fixed, not removable, tray-in 160GB⁸ (5400 rpm) or 320GB (5400 rpm) / SATA 1.5Gb/s, 9.5mm high, removable, upgradable, ThinkPad Shock Mounted Hard Drive, Active Protection System™				
Widescreen display	Some: 15.4" (391.2mm) WXGA (1280x800) color, VibrantView (glossy), CCFL backlight, 200 nits, 16:10 aspect ratio, 300:1 contrast ratio Some: 15.4" (391.2mm) WSXGA+ (1680x1050) color , anti-glare, CCFL backlight, 200 nits, 16:10 aspect ratio, 300:1 contrast ratio				
Camera	Camera on top of screen, 2.0-megapixel, fixed focus				
Discrete graphics	NVIDIA® GeForce 9300M , PCI Express® x16, 256MB memory, HDMI port supporting HDCP to output protected content; <i>Max external resolution:</i> 2048x1536@85Hz (DB-15 port); 1920x1080 (HDMI port)				
Keyboard TrackPoint® Touch pad Lighting FX	6-row, Lenovo Care button, spill-resistant, multimedia Fn keys TrackPoint® pointing device, Internet Scroll Bar ¹³ , magnifying glass UltraNav™, wide touch pad below keyboard, Tap Zones, scrolling regions label Illuminated power button, Lenovo Care button, ThinkPad logo				
Dimensions ³ Weight ² Case Battery - type Battery - life ¹⁰	<i>6-cell 15.4W"</i> (WxDxH): 14.1" x 10.2" x 1.46-1.53"; 358 x 260mm x 37-39mm <i>6-cell:</i> starting at 6.3 lb (2.9kg); <i>9-cell:</i> starting at 6.7 lb (3.0kg) <i>Color:</i> black; <i>Material:</i> scratch-resistant ABS plastic, high-gloss top cover Lithium Ion 6-cell or 9-cell <i>6-cell:</i> up to 3 hr; <i>9-cell:</i> up to 4.9 hr				
Chipset	Mobile Intel PM45 Express Chipset (Memory Controller Hub), ICH9M I/O Controller Hub (SATA 3.0Gb/s, USB 2.0, PCI Express® 1.1, PCI 2.3, security chip, ethernet MAC), LPC bus (IT8752 Super I/O)				
ExpressCard Multicard Reader PC Card Std Smart Card Read Ports	One slot (ExpressCard/34, ExpressCard/54) 7-in-1 reader (MMC, Memory Stick, Mem Stick Pro, SD, SDHC, XD, XD Type H) None None Four USB 2.0, external monitor (VGA DB-15, HDMI), modem (RJ-11), ethernet (RJ-45), IEEE 1394 FireWire 400 (4-pin connector; 1394a-2000 standard)				
Mini PCI Express Intel 5100 ²⁸ WWAN upg AT&T ²³ 2G Turbo UWB Modem Bluetooth™ Ethernet Intel AMT Audio support	Three Mini PCI Express slots 11a/b/g/n wireless ⁴ , Mini PCIe adapter, Intel WiFi Link 5100, 1x2 (Shirley Peak) Some: Wireless WAN upgradable, optional AT&T® (43R9152) Some: Wireless WAN, Ericsson chipset, Mini PCIe adapter and SIM, GPRS/WCDMA/HSPA, GPS, service contract required with AT&T® Some: Intel Turbo Memory, Half-Mini PCIe adapter, 2GB flash, disk-cache accelerator None 56K V.92 ⁶ modem Bluetooth 2.0 wireless, LED indicator Realtek RTL8111C Gigabit Network Connection, PHY, PCIe x1 None High Definition (HD) Audio, CX20561-15Z codec / stereo speakers, 2 watt / volume up, down, mute buttons / dual array microphone, mic input jack, headphone jack				
Security Security chip Fingerprint reader	Power-on password, hard disk password, supervisor password, security keyhole None Fingerprint reader on palm rest, swipe sensor, supports the security chip				
Limited warranty ¹²	1-year - EasyServ™ ¹⁹ depot repair service / service upgrades ²² available				
1GB PC2-5300 DDR2 SODIMM (TopSeller)	43R1999		T/R/W/SL Series Li-Ion Battery 6-cell	40Y6799	ThinkPlus 2-year P&L P/U Depot
2GB PC2-5300 DDR2 SODIMM (TopSeller)	43R2000		T/R/W/SL Series Li-Ion Battery 9-cell	40Y6797	41C9169
SL 320GB Disk SATA 1.5Gb/s (5400 rpm)	43N3405	ThinkPad 90W AC Adapter	40Y7659	ThinkPlus 3-year P&L P/U Depot	
USB 2.0 Essential Memory Key 32GB	45K1258	90W Slim AC/DC Combo Adapter	41N8460	41C9170	
USB 2.0 Portable Secure 320GB Hard Disk	43R2019	ThinkPad Business Topload Case	43R2476	ThinkPlus 4-year P&L P/U Depot	
USB 2.0 Lenovo Enhanced Port Replicator	43R8770	ThinkPad Business Backpack	43R2482	41C9172	
ThinkPad Convertible Monitor Stand	40Y7620	ThinkVision® L2240p Wide 22" Monitor	4422HB6	Post-warranty annual maintenance agreements at	
Laser Tilt Wheel Travel Mouse (Bluetooth)	41U5008	ThinkVision L2440p Wide 24" Monitor	4420HB2	lenovo.com/thinkplus/warranty	
Other accessories on O-SL500 sheet		Other accessories at lenovo.com/accessories			

See footnotes for important warranty information

♦ Intel Centrino® 2 processor technology

☞ US models announced July 29, 2008; previous models on July 15, 2008

< US models withdrawn effective September 2008

© Lenovo
(TAR1-2) August 2008

Partial list of accessories supported on:

- ThinkPad SL500 originally announced on July 15, 2008

Memory

512MB PC2-5300 DDR2 SODIMM	40Y7733	ann 01/05/06
1GB PC2-5300 DDR2 SODIMM (TopSeller)	43R1999	ann 03/25/08
1GB PC2-5300 DDR2 SODIMM	40Y7734	ann 01/05/06
2GB PC2-5300 DDR2 SODIMM (TopSeller)	43R2000	ann 03/25/08
2GB PC2-5300 DDR2 SODIMM	40Y7735	ann 11/28/06

Storage and removable storage

SL 320GB Disk SATA 1.5Gb/s (5400 rpm)	43N3405	ann 07/15/08
USB 2.0 Essential Memory Key 2GB	41U4944	ann 01/23/07
USB 2.0 Essential Memory Key 4GB	45J7904	ann 06/24/08
USB 2.0 Essential Memory Key 8GB	45J7905	ann 07/15/08
USB 2.0 Essential Memory Key 32GB	45K1258	ann 10/28/08
USB 2.0 Security Memory Key 2GB	41U5119	ann 07/17/07
USB 2.0 Security Memory Key 4GB	41U5120	ann 07/17/07
USB 2.0 Ultra Secure Memory Key 1GB	45J5915	ann 08/26/08
USB 2.0 Ultra Secure Memory Key 2GB	45J5916	ann 08/26/08
USB 2.0 Ultra Secure Memory Key 4GB	45J5917	ann 08/26/08
USB 2.0 Ultra Secure Memory Key 8GB	45J5918	ann 08/26/08
USB Portable Diskette Drive	05K9276	ann 06/05/00
USB 2.0 CD-RW/DVD-ROM Combo II Drive	40Y8637	ann 01/05/06
USB 2.0 Portable 160GB Hard Disk	43R1784	ann 09/23/08
USB 2.0 Portable Secure 160GB Hard Disk	43R2018	ann 11/18/08
USB 2.0 Portable Secure 320GB Hard Disk	43R2019	ann 11/18/08
USB 2.0 Super Multi-Burner Drive	41N5565	ann 01/23/07

Wireless WAN (Mini PCI Express)

Only WWAN upgradable models:

AT&T WWAN HSPA Broadband Mini PCIe	43R9152	ann 08/26/08
------------------------------------	---------	--------------

ThinkPad Expansion

USB 2.0 Lenovo Enhanced Port Replicator	43R8770	ann 02/26/08
ThinkPad Adjustable Notebook Stand	40Y7676	ann 09/20/05

Keyboard

TrackPoint Cap Collection	73P2698	ann 12/16/03
USB Numeric Keypad	33L3225	ann 05/01/00
Preferred Pro USB Keyboard	73P5220	ann 06/21/05
Enhanced Performance USB Keyboard	73P2620	ann 03/23/04
Wireless Kybd & Opt Wheel Mouse (via USB)	73P4067	ann 12/07/04
USB Keyboard with UltraNav	31P8950	ann 01/28/03
USB Travel Keyboard with UltraNav	31P9490	ann 04/27/04
Preferred Pro USB Fingerprint Keyboard	73P4730	ann 02/22/05

Mouse

Optical Wheel Mouse (USB)	06P4069	ann 05/21/03
Optical ScrollPoint® Mouse (USB, PS/2)	31P7405	ann 08/27/02
Optical Wheel Travel Mouse (USB, PS/2)	31P7410	ann 06/04/02
Laser Tilt Wheel Mouse (USB, PS/2)	41U3074	ann 01/23/07
Lenovo Wireless Laser Mouse (blk, via USB)	45K1696	ann 11/25/08
Lenovo Wireless Laser Mouse (red, via USB)	51J0198	ann 11/25/08
Laser Tilt Wheel Travel Mouse (Bluetooth)	41U5008	ann 01/22/08

Security

Kensington® Cable Lock from Lenovo	73P2582	ann 12/29/03
Kensington Twin Head Cable Lock	45K1620	ann 09/30/08
USB Gemplus GemPC Smart Card Reader	41N3040	ann 02/21/06
ExpressCard Gemplus Smart Card Reader ⁴⁷	41N3043	ann 06/27/06

⁴⁷ Requires ExpressCard slot

Multimedia

USB 2.0 Lenovo Multimedia Headset	40Y8518	ann 06/27/06
USB 2.0 Lenovo Webcam	40Y8519	ann 08/29/06

Batteries

T/R/W/SL Series Li-Ion Battery 6-cell	40Y6799	ann 01/05/06
T/R/W/SL Series Li-Ion Battery 9-cell	40Y6797	ann 09/20/05
ThinkPad External Battery Charger ⁴⁴	40Y7625	ann 09/20/05

⁴⁴ Requires the *ThinkPad 90W AC Adapter*

40Y7659 (adapter provided with some systems).

More information at www.lenovo.com/alldaycomputing

ThinkPad 65W AC Adapter ⁴⁵	40Y7696	ann 01/05/06
⁴⁵ Only compatible with the GM45 chipset models.		
ThinkPad 90W AC Adapter	40Y7659	ann 09/20/05
ThinkPad 90W Slim AC/DC Combo Adapter	41N8460	ann 11/27/07

More info at www.lenovo.com/support/poweradapters

Charging tips for 90W Slim AC/DC Combo Adapter 41N8460

•Dual (ThinkPad+Phone) Charging Y-Cable	41R4345	ann 12/18/07
•Palm device charge tip (L7)	41R4315	ann 12/18/07
•BlackBerry charge tip (L8a)	41R4478	ann 12/18/07
•iPod and iPhone charge tip (L10a)	41R4481	ann 12/18/07

More information at www.lenovo.com/support/slimadaptertips

Carrying Cases

Up to 15.4" widescreen models:

Lenovo Carrying Case - Messenger Max	41U5253	ann 05/01/07
Lenovo Carr Case - Performance Backpack	41U5254	ann 05/01/07
Lenovo Standard Case	45K1697	ann 11/25/08
Lenovo Standard Backpack	45K1698	ann 11/25/08
ThinkPad Business Topload Case	43R2476	ann 05/13/08
ThinkPad Business Backpack	43R2482	ann 05/13/08
ThinkPad Deluxe Expander Case	43R2478	ann 05/13/08
ThinkPad Executive Leather Case	43R2480	ann 05/13/08

Up to 17.0" widescreen models:

ThinkPad 17W Business Topload Case	43R9117	ann 08/12/08
------------------------------------	---------	--------------

Lenovo luxury cases at www.lenovoluxurycases.com

Monitors

ThinkVision® L174 17" Monitor	9227AE1	ann 04/15/08
ThinkVision L1700p 17" Monitor	9417HE2	ann 09/17/08
ThinkVision L1900p 19" Monitor	4431HE1	ann 11/11/08
ThinkVision L1940p Wide 19" Monitor	4424HB6	ann 09/17/08
ThinkVision L200p Wide 20.1" Monitor	4438HB6	ann 04/15/08
ThinkVision L2240p Wide 22" Monitor	4422HB6	ann 09/17/08
ThinkVision L2440p Wide 24" Monitor	4420HB2	ann 09/17/08
ThinkVision L2440x Wide 24" Monitor	4421HB2	ann 09/17/08

Monitor Accessories⁴⁶

ThinkVision USB Soundbar	40Y7616	ann 08/23/05
ThinkVision Soundbar	45K1263	ann 09/16/08
Kensington Cable Lock from Lenovo	73P2582	ann 12/29/03
Kensington Twin Head Cable Lock	45K1620	ann 09/30/08
ThinkPad Convertible Monitor Stand	40Y7620	ann 01/05/06
Radial Arm	19K4464	ann 05/05/00

⁴⁶ Compatible on selected Lenovo and ThinkVision monitors.

More information at www.lenovo.com/support/monitoraccessories

Other accessories at www.lenovo.com/accessories

Accessories Guide pdf at www.lenovo.com/accessoriesguide

Availability: All offers subject to availability. Lenovo reserves the right to alter product offerings and specifications at any time, without notice. Lenovo is not responsible for photographic or typographic errors.

Warranty: For a copy of applicable product warranties, write to: Warranty Information, P.O. Box 12195, RTP, NC, 27709, Attn: Dept ZPYA/B676. Lenovo makes no representation or warranty regarding third party products or services.

Footnotes:

- ¹ Power management, including Intel® SpeedStep® Technology, reduces processor speed when in battery mode.
- ² **Weight** includes battery and standard optical drive; weight may vary due to vendor components, manufacturing process and options.
- ³ **Thinness** may vary at certain points on the system.
- ⁴ **Wireless capability:** Requires compatible wireless-enabled options sold separately.
- ⁶ **Public network download modem speeds** are limited to 53Kbps. Upload speeds are limited to 48Kbps for V.92 modems. Actual speeds depend on many factors and are often less than the maximum possible. V.92 functions and speeds require compatible phone line and server equipment. Check with your telephone and ISP service providers for availability.
- ⁷ **Maximum memory capacity** may require the replacement of standard component with largest supported component available. On ThinkPad systems, even though it is possible to physically install 4GB of memory, the actual amount of memory addressable by a 32-bit operating system will be limited to 3GB. This limitation does not exist with 64-bit operating systems Windows XP Professional 64-bit and Windows Vista 64-bit Editions.
- ⁸ **Hard drive:** GB = billion bytes, TB = trillion bytes. Accessible capacity is less; up to 4GB is service partition.

¹⁰ **Battery:** These model numbers achieved the battery life based on MobileMark® 2007 during testing. Battery life (and recharge times) will vary based on many factors including screen brightness, applications, features, power management, battery conditioning, and other customer preferences.

¹² **Limited warranty:** Support unrelated to a warranty issue may be subject to additional charges.

¹³ **Internet access not included.**

¹⁴ **Included software** may differ from its retail version (if available), and may not include user manuals or all program functionality. Software license agreements may apply.

¹⁶ **Activating Verizon Wireless Service:** Lenovo customers will be contacted after purchase to activate service; requires separate agreement with Verizon Wireless and is subject to the Customer Agreement, Calling Plan, and credit approval. Service, airtime, and early termination charges may apply. Verizon Wireless, not Lenovo, is solely responsible for service. Service not available in all areas; purchaser is responsible for verifying that service is available for the intended location before purchasing a computer equipped with WAN card. Network details, coverage limitations, and maps at www.verizonwireless.com.

¹⁷ **International Warranty Service** is available in any country in which this product is sold and serviced. Service delivery methods and parts availability vary by country, may be different from that in the country of purchase, and are subject to change without notice. Fees and restrictions may apply in some countries.

¹⁸ **Telephone support** may be subject to additional charges, even during the limited warranty period. Response times may vary. May exclude some holidays. If a machine is listed as having "On-site service for select repairs", this means that onsite service is available only for the replacement of select parts. For all other warranty repairs, Lenovo will provide the customer a replacement part for customer installation. The parts for which onsite service is available varies by machine, but may include the processor, power supply, heat sink, system board, or base cover. For ThinkPad notebooks with EasyServ or Courier service, Lenovo will attempt to diagnose and resolve the problem remotely before sending a courier.

¹⁹ **EasyServ depot repair service:** In the United States call 1-800-426-7378. The customer may be asked certain diagnostic questions before a courier is sent. Your ThinkPad purchase includes this depot repair service, available in the U.S. during the limited warranty period.

²⁰ **Operating System:** Level of support varies by operating system. Operating systems not preloaded on the system may not provide full feature functionality. Refer to lenovo.com/pc/support and enter your machine type and model number for more information.

²² **ThinkPlus Services:** These services are available for machines normally used for business, professional, or trade purposes, rather than personal, family, or household purposes. Not all machine types and models are covered. Service period begins with the equipment date of purchase. Service must be purchased during the original limited product warranty period. Service levels are response time objectives and are not guarantees. If the machine problem turns out to be a Customer Replaceable Unit (CRU), a part will be express shipped to you for quick replacement. Onsite 24x7x2-hour service is not available in all locations. For ThinkPad notebooks requiring LCD or other component replacement, Lenovo may choose to perform service at the depot repair center. Calls must be received by 5 pm local time in order to qualify for Next Business Day service. P&L means parts and labor. P/U means pick-up. See ThinkPlus terms and conditions for complete details and restrictions.

²³ **Activating AT&T Wireless Service:** Requires separate agreement with AT&T, subject to service agreement, rate plan and coverage maps. AT&T, not Lenovo, is solely responsible for service. Coverage not available in all areas; AT&T BroadbandConnect available in select metropolitan markets. Special credit and tenure restrictions and additional charges may apply to international roaming. A network connection, third-party software, additional hardware, and/or subscription to a third-party service may be required for certain solutions/applications. Additional restrictions apply, including early termination fee; see www.wireless.att.com for details. To activate call Lenovo Wireless Activation Hot Line at 1-877-299-4710.

²⁴ **Limited onsite service systems** are designed to be repaired during the applicable warranty period primarily with customer-replaceable parts provided by Lenovo. Lenovo will only send a technician onsite to perform a repair if (a) remote telephone diagnosis and/or customer part replacement are unable to resolve the problem, or (b) the part is one of the few designated by Lenovo for onsite replacement. For a list of onsite replaceable parts, contact Lenovo. In the United States call 1-800-426-7378. Support unrelated to a warranty issue may be subject to additional charges. Lenovo onsite repair (LOR), 8 am to 5 pm, Monday through Friday coverage excluding holidays, next business day (NBD) response time.

²⁷ **Based on IEEE 802.11a and 802.11b.** A customer can not upgrade to a different wireless Mini PCI adapter due to FCC regulations. Security screws prevent removal of this adapter. This wireless LAN product has been designed to permit legal operation world-wide in regions which it is approved. This product has been tested and certified to be interoperable by the Wireless Ethernet Compatibility Alliance and is authorized to carry the Wi-Fi logo.

²⁸ **The IEEE 802.11n specification (MIMO)** has not been finalized and is currently in draft release. The ThinkPad 11a/b/g/n (11n) Wireless LAN Mini PCI Express Adapters are based on the Draft Release, Version 1.02, of the IEEE 802.11n specification. The Intel Mini PCI Express Adapters are based on the Draft Release, Version 2.0 of the IEEE 802.11n specification. The maximum speed depends on the access point device and the number of integrated antenna used for connection. An adapter with 11a/b, 11a/b/g, or 11a/b/g/n can communicate on any of its supported formats.

³⁰ **Measures only maximum** data transfer rate, not application performance. Many factors affect application performance.

³² **Wireless:** Based on IEEE 802.11a, 802.11b, and 802.11g respectively. An adapter with 11a/b, 11b/g, or 11a/b/g can communicate on either/any of these listed formats respectively, the actual connection will be based on the access point to which it connects.

³⁵ **Operating system:** Level of support varies by operating system. Operating systems not preloaded on the system may not provide full feature functionality. Refer to lenovo.com/think/support and enter your machine type and model number for more information.

This publication was developed for products and services offered in the United States. Lenovo may not offer the products, services or features discussed in this document in other countries. Lenovo may withdraw an offering at any time. Information is subject to change without notice. Consult your local representative for information on offerings available in your area.

Lenovo reserves the right to change specifications or other product information without notice. Lenovo is not responsible for photographic or typographical errors. LENOVO PROVIDES THIS PUBLICATION "AS IS," WITHOUT WARRANTY OF ANY KIND, EITHER EXPRESS OR IMPLIED, INCLUDING THE IMPLIED WARRANTIES OF MERCHANTABILITY OR FITNESS FOR A PARTICULAR PURPOSE. Some jurisdictions do not allow disclaimer of express or implied warranties in certain transactions, therefore this disclaimer may not apply to you.

The ThinkPad logo consists of the word "ThinkPad" in a bold, black, sans-serif font. A small red dot is positioned above the letter "i". A registered trademark symbol (®) is located to the upper right of the word.

Trademarks: Lenovo, the Lenovo logo, New World. New Thinking., Access Connections, Active Protection System, Rescue and Recovery, ThinkPad, ThinkVantage, ThinkVision, ThinkPlus, ThinkCentre, TrackPoint, UltraConnect, UltraNav, and Ultrabay are trademarks or registered trademarks of Lenovo. The Bluetooth word mark and logos are owned by the Bluetooth SIG, Inc. Any use of such marks by Lenovo is under license. Microsoft, Windows, and Vista are registered trademarks of Microsoft Corporation. Intel, the Intel logo, Intel Inside logo, Intel Core and Core Inside, Intel Centrino logo, Pentium, Celeron and Intel SpeedStep are trademarks or registered trademarks of Intel Corporation or its subsidiaries in the United States and other countries. Cisco and Aironet are registered trademarks of Cisco Corporation. Linux is a trademark of Linus Torvalds in the United States, other countries, or both. Other company, product and service names may be trademarks or service marks of others.

Visit www.lenovo.com/safecomputing periodically for the latest information on safe and effective computing.

Visit www.lenovo.com/psref for the latest version of Personal Systems Reference.

© Lenovo, 2009.
All rights reserved.

Lenovo
1009 Think Place
Morrisville, NC 27560
U.S.A.

January 2009
slbook.pdf

ThinkCentre®

Personal Systems Reference Lenovo ThinkCentre Desktops

January 2009 - Version 350



Lenovo ThinkCentre M58p Eco Ultra Small
with ThinkVision 2440x Wide monitor

lenovo.com

Customers and employees can receive notification of each release via a distribution list by sending their e-mail address to rdodson@lenovo.com



Lenovo ThinkCentre M57e Small



Lenovo ThinkCentre M57e Small



Lenovo ThinkCentre M57e Desktop



Lenovo ThinkCentre M57e Desktop with Lenovo ThinkVision monitor



Lenovo ThinkCentre M57e Tower



Lenovo ThinkCentre M57e Tower with dual Lenovo ThinkVision monitors

ThinkCentre® M57e Small (6305) - TopSeller

Personal Systems Reference (PSREF)

Name	Type-model	Slot x bay	Processor	GHz	L2 cache	Core	Memory ⁸	SATA disk	SATA optical	Graphics	Preload	Vista logo	Global Educ	Avail date
M57e	6305-B1U	2x3	Pentium E2200	2.20	1MB	Dual	1GB	160GB ²	DVD	GMA	XP Pro		None	Jun 08
M57e	6305-B2U	2x3	Pentium E2200	2.20	1MB	Dual	2GB	160GB	DVD±RW	GMA	XP Pro		None	Jun 08
M57e	6305-B4U	2x3	Core 2 Duo E7200	2.53	3MB	Dual	1GB	160GB	DVD	GMA	XP Pro		None	Jun 08
M57e	6305-B3U	2x3	Core 2 Duo E7200	2.53	3MB	Dual	2GB	160GB	DVD±RW	GMA	XP Pro		None	Jun 08
M57e	6305-B5U	2x3	Core 2 Duo E8400	3.00	6MB	Dual	2GB	160GB	DVD±RW	GMA	XP Pro		None	Jun 08
M57e	6305-B6U	2x3	Core 2 Quad Q6600	2.40	8MB	Quad	2GB	160GB	DVD±RW	GMA	XP Pro		None	Jun 08
ES	M57e	6305-B7U	Pentium E2200	2.20	1MB	Dual	1GB	160GB	DVD	GMA	Business32	Premium	None	Sep 08
ES	M57e	6305-B8U	Pentium E2200	2.20	1MB	Dual	2GB	160GB	DVD±RW	GMA	Business32	Premium	None	Sep 08
ES	M57e	6305-B9U	Core 2 Quad Q6600	2.40	8MB	Quad	2GB	160GB	DVD±RW	GMA	Business32	Premium	None	Sep 08

- These small and medium business (SMB) models are part of the US TopSeller™ Program
- These models have a 3-year limited warranty¹

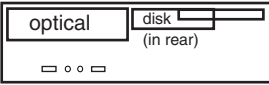
Positioning Processor	<p><i>Stability and manageability for small and medium businesses</i></p> <p>Intel® Pentium® Dual-Core Processor E2200 with dual-core, Intel 64 Technology, Execute Disable Bit, EIST, 800MHz system bus, and 1MB L2 cache or Intel Core™ 2 Duo Processor E7200 with dual-core, Intel 64 Technology, Execute Disable Bit, EIST, 1066MHz system bus, and 3MB L2 cache or Intel Core 2 Duo Processor E8400 with dual-core, Intel 64 Technology, Virtualization Technology, Execute Disable Bit, EIST, TXT, 1333MHz system bus, and 6MB L2 cache or Intel Core 2 Quad Processor Q6600 with quad-core (dual-core on dual-die), Intel 64 Technology, Virtualization Technology, Execute Disable Bit, EIST, and 1066MHz system bus with 8MB L2 cache</p> <p>Processor in FC-LGA6 or FC-LGA8 package in LGA775 socket</p>	<p>Small</p>  <p>Bay ① 5.25", 1.6" high, access, std optical Bay ② 3.5", 1" high, no access, std disk Bay ③ 3.5", .5" high, access, open (reader/diskette)</p> <p>Slot 1: Low Profile, PCI Express x16 (35w max) Slot 2: Low Profile, 32-bit PCI 2.3</p> <ul style="list-style-type: none"> • Business black color; metal case • 12.5" W X 14.0" D X 3.9" H • 317mm W X 355mm D X 99mm H • 16.1 lb (7.3 kg) in maximum configuration • Bays 1, 2, 3 flip up (latched and pivoting) • Toolless cover flips up and tilts backward on rear hinges • Toolless disk, diskette drive, optical drive removal • Toolless adapter retention • Toolless systemboard retention • Steel chassis supports 100 lb (45kg) monitor on top • System floor stand for vertical orientation 																								
Implementation	Processor in FC-LGA6 or FC-LGA8 package in LGA775 socket																									
Memory	<p>1GB or 2GB std., 4GB max⁸, PC2-5300 667MHz DDR2, non-parity, dual-channel capable, two 240-pin DIMM sockets; <i>Italics:</i> standard memory in both sockets; no sockets avail; <i>Non-italics:</i> standard memory in one socket; one socket available</p>																									
Graphics	<p>Intel Graphics Media Accelerator 3100 (GMA 3100), integrated graphics in G31, uses main memory (up to 256MB), one analog VGA DB-15 connector, supports dual independent display with optional ADD2 adapter</p>																									
SATA disk	<p>160GB, SATA 3.0Gb/s 7200 rpm, vibration dampening mounts</p>																									
SATA controller	Serial ATA, SATA 3.0Gb/s, integrated in ICH7																									
SATA DVD	<i>Some:</i> DVD-ROM DL SATA 1.5Gb/s 16-48X Max ⁴ Drive (41N5618)																									
SATA DVD±RW	<i>Some:</i> Super Multi-Burner DL DVD±RW SATA 1.5Gb/s Drive (41N5620)																									
SATA cables	Two SATA cables (each 1-drop to device), two SATA connectors on planar																									
eSATA port	None																									
EIDE controller	Enhanced IDE, ATA-100, integrated in ICH7, one EIDE connector on planar																									
Diskette drive	None																									
Media reader	None																									
Chipset	<p>Intel G31 Express Chipset; I/O Controller Hub 7 (ICH7) for SATA 3.0Gb/s, ATA-100 EIDE, PCI Express[®] x1, PCI 2.3, USB, LPC bus / ITE Tech[®] IT8718 Super I/O for serial, parallel, keyboard, mouse functions</p>																									
Front ports	Two USB 2.0, microphone (stereo, 3.5mm), headphone (stereo, 3.5mm)																									
Rear ports	Four USB 2.0, serial (9-pin), parallel (25-pin), keyboard (PS/2), mouse (PS/2), ethernet (RJ-45), monitor (VGA DB-15)																									
Internal connector	Two USB 2.0 planar connectors (one used; one open for media reader)																									
Rear audio ports	Line-in (stereo, 3.5mm), line-out (stereo, 3.5mm), microphone (stereo, 3.5mm)																									
Audio	High Definition (HD) Audio, Realtek [®] ALC662 codec																									
Speaker	One internal speaker for business audio																									
Ethernet	Gigabit ethernet on planar, Marvell [®] 88E8056, PCIe x1, Wake on LAN [®]																									
Intel AMT	None																									
Modem	None																									
Security chip	None																									
Keyboard	Preferred Pro USB Keyboard (USB connector), 104-key, black, Lenovo logo																									
Mouse	Optical Wheel Mouse (USB connector), 400 dpi, black, Lenovo logo																									
Power supply	280 watts with variable speed fan, autosensing																									
Preloaded operating system²⁰	<p>- <i>Some:</i> Microsoft[®] Windows[®] XP Professional with Vista[®] COA</p> <p>- <i>Some:</i> Microsoft Windows Vista Business Edition (32-bit)</p>	<p>Accessories</p> <table border="0"> <tr> <td>1GB PC2-5300 CL5 NP DDR2 UDIMM</td> <td>73P4984</td> </tr> <tr> <td>2GB PC2-5300 CL5 NP DDR2 UDIMM</td> <td>73P4985</td> </tr> <tr> <td>1GB PC2-6400 NP DDR2 UDIMM</td> <td>41U2977</td> </tr> <tr> <td>2GB PC2-6400 NP DDR2 UDIMM</td> <td>41U2978</td> </tr> <tr> <td>USB 2.0 Lenovo Multimedia Headset</td> <td>40Y8518</td> </tr> <tr> <td>ThinkVision[®] L2440p Wide 24" Monitor</td> <td>4420HB2</td> </tr> <tr> <td>Wireless Kbd & Opt Wheel Mouse (via USB)</td> <td>73P4067</td> </tr> <tr> <td>Kensington Cable Lock from Lenovo</td> <td>73P2582</td> </tr> <tr> <td>ADD2 DVI-I PCIe Connection Adapter</td> <td>73P2516</td> </tr> <tr> <td>ADD2 DVI-D Monitor Connection (HDCP)</td> <td>43R1985</td> </tr> <tr> <td>ATI[™] Radeon[™] HD 2400 Pro 128MB</td> <td>43R1961</td> </tr> <tr> <td>ATI Radeon HD 2400 XT 256MB</td> <td>43R1962</td> </tr> </table> <p>Acc Guide in pdf lenovo.com/accessoriesguide Other accessories at lenovo.com/accessories</p>	1GB PC2-5300 CL5 NP DDR2 UDIMM	73P4984	2GB PC2-5300 CL5 NP DDR2 UDIMM	73P4985	1GB PC2-6400 NP DDR2 UDIMM	41U2977	2GB PC2-6400 NP DDR2 UDIMM	41U2978	USB 2.0 Lenovo Multimedia Headset	40Y8518	ThinkVision [®] L2440p Wide 24" Monitor	4420HB2	Wireless Kbd & Opt Wheel Mouse (via USB)	73P4067	Kensington Cable Lock from Lenovo	73P2582	ADD2 DVI-I PCIe Connection Adapter	73P2516	ADD2 DVI-D Monitor Connection (HDCP)	43R1985	ATI [™] Radeon [™] HD 2400 Pro 128MB	43R1961	ATI Radeon HD 2400 XT 256MB	43R1962
1GB PC2-5300 CL5 NP DDR2 UDIMM	73P4984																									
2GB PC2-5300 CL5 NP DDR2 UDIMM	73P4985																									
1GB PC2-6400 NP DDR2 UDIMM	41U2977																									
2GB PC2-6400 NP DDR2 UDIMM	41U2978																									
USB 2.0 Lenovo Multimedia Headset	40Y8518																									
ThinkVision [®] L2440p Wide 24" Monitor	4420HB2																									
Wireless Kbd & Opt Wheel Mouse (via USB)	73P4067																									
Kensington Cable Lock from Lenovo	73P2582																									
ADD2 DVI-I PCIe Connection Adapter	73P2516																									
ADD2 DVI-D Monitor Connection (HDCP)	43R1985																									
ATI [™] Radeon [™] HD 2400 Pro 128MB	43R1961																									
ATI Radeon HD 2400 XT 256MB	43R1962																									
Preloaded applications⁵ (all OSes; only some listed)	<ul style="list-style-type: none"> • Rescue and Recovery[™] • Client Security Solution[™] • ThinkVantage Productivity Center • ThinkVantage System Update • Norton Internet Security[™] • Diskkeeper[®] Home • Microsoft Office 2007 Trial (60-day) • Corel[®] WinDVD[®] (DVD, DVD±RW) 	<p>Security</p> <ul style="list-style-type: none"> • Security slot (in rear for attachment of optional Kensington[®] Microsaver[®] cable) - optional cable also locks the cover by deactivating the cover release buttons • Power-on password • Administrator password • Hard disk password • Boot sequence control • Boot without keyboard, mouse, diskette • Serial port I/O control • Parallel port I/O control • USB port disablement <p>Supports ThinkVantage[®] technologies</p> <p>RoHS-compliant</p> <p>Limited Warranty¹</p> <ul style="list-style-type: none"> ↪ 3-year parts and labor ↪ International Warranty Service⁹ ↪ Customer Replaceable Unit (CRU) parts only (with limited onsite service for selected parts³, 8 am - 5 pm, Mon - Fri coverage excluding holidays, next business day response time) ↪ Onsite service upgrade options (in eligible locations):⁷ <ul style="list-style-type: none"> • 3-year LOR 9x5, 4 hour response (ThinkPlus[™] part number 41C9192) • 3-year LOR 24x7, 4 hour response (ThinkPlus part number 41C9193) • 4-year LOR 9x5, Next Business Day (ThinkPlus part number 41C9194) • 4-year LOR 9x5, 4 hour response (ThinkPlus part number 41C9195) • 4-year LOR 24x7, 4 hour response (ThinkPlus part number 41C9196) ↪ ThinkPlus services at lenovo.com/thinkplus/warranty ↪ Post warranty maintenance services available ↪ 24 hour x 7 day¹⁴ toll-free support during the warranty period¹ via 800-426-7378 																								

See footnotes for important warranty information

ES US models announced August 19, 2008; previous models on June 24, 2008

© Lenovo (MONA2-4) August 2008

Name	Type-model	Slot x bay	Processor	GHz	L2 cache	Cores	Memory ⁸	SATA disk	SATA optical	Graphics	Preload	Vista logo	Global Educ	Avail date
M57e	6305-BBU	2x3	Pentium E5200	2.50	2MB	2	1GB	160GB ²	DVD	GMA	XP Pro	Premium	None	Nov 08
M57e	6305-BCU	2x3	Pentium E5200	2.50	2MB	2	2GB	160GB	DVD±RW	GMA	XP Pro	Premium	None	Nov 08
M57e	6305-BEU	2x3	Core 2 Duo E7300	2.66	3MB	2	1GB	160GB	DVD	GMA	XP Pro	Premium	None	Nov 08
M57e	6305-BDU	2x3	Core 2 Duo E7300	2.66	3MB	2	2GB	160GB	DVD±RW	GMA	XP Pro	Premium	None	Nov 08

- These small and medium business (SMB) models are part of the US TopSeller™ Program
- These models have a 3-year limited warranty¹

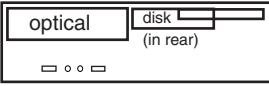
Positioning Processor	Stability and manageability for small and medium businesses Intel® Pentium® Dual-Core Processor E5200 with dual-core, 800MHz system bus, and 2MB L2 cache or Intel Core™ 2 Duo Processor E7300 with dual-core, 1066MHz system bus, and 3MB L2 cache Processor in FC-LGA6 or FC-LGA8 package in LGA775 socket		Small 																																														
Implementation	Bay ① 5.25", 1.6" high, access, std optical Bay ② 3.5", 1" high, no access, std disk Bay ③ 3.5", .5" high, access, open (reader/diskette)																																																
Memory	1GB or 2GB std , 4GB max ⁸ , PC2-5300 667MHz DDR2 , non-parity, dual-channel capable, two 240-pin DIMM sockets; <i>Non-italics:</i> standard memory in one socket; one socket available		Slot 1: Low Profile, PCI Express x16 (35w max) Slot 2: Low Profile, 32-bit PCI 2.3																																														
Graphics	Intel Graphics Media Accelerator 3100 (GMA 3100) , integrated graphics in G31, uses main memory (up to 256MB), one analog VGA DB-15 connector, supports dual independent display with optional ADD2 adapter		<ul style="list-style-type: none"> • Business black color; metal case • 12.5" W X 14.0" D X 3.9" H • 317mm W X 355mm D X 99mm H • 16.1 lb (7.3 kg) in maximum configuration • Bays 1, 2, 3 flip up (latched and pivoting) • Toolless cover flips up and tilts backward on rear hinges • Toolless disk, diskette drive, optical drive removal • Toolless adapter retention • Toolless systemboard retention • Steel chassis supports 100 lb (45kg) monitor on top • System floor stand for vertical orientation 																																														
SATA disk	160GB , SATA 3.0Gb/s 7200 rpm, vibration dampening mounts SATA controller Serial ATA, SATA 3.0Gb/s, integrated in ICH7 SATA DVD None SATA DVD±RW <i>Some:</i> DVD-ROM DL SATA 1.5Gb/s 16-48X Max ⁴ Drive (41N5618) SATA cables <i>Some:</i> Super Multi-Burner DL DVD±RW SATA Drive (41N5620) eSATA port Two SATA cables (each 1-drop to device), two SATA connectors EIDE controller None Diskette drive Enhanced IDE, ATA-100, integrated in ICH7, one EIDE connector Media reader None		Security <ul style="list-style-type: none"> • Security slot (in rear for attachment of optional Kensington® Microsaver® cable) - optional cable also locks the cover by deactivating the cover release buttons • Power-on password • Administrator password • Hard disk password • Boot sequence control • Boot without keyboard, mouse, diskette • Serial port I/O control • Parallel port I/O control • USB port disablement 																																														
Chipset	Intel G31 Express Chipset ; I/O Controller Hub 7 (ICH7) for SATA 3.0Gb/s, ATA-100 EIDE, PCI Express® x1, PCI 2.3, USB, LPC bus / ITE Tech® IT8718 Super I/O for serial, parallel, keyboard, mouse functions		Supports ThinkVantage® technologies																																														
Front ports	Two USB 2.0, microphone (stereo, 3.5mm), headphone (stereo, 3.5mm)		RoHS-compliant																																														
Rear ports	Four USB 2.0, serial (9-pin), parallel (25-pin), keyboard (PS/2), mouse (PS/2), ethernet (RJ-45), monitor (VGA DB-15)																																																
Internal connector	Two USB 2.0 planar connectors (one used; one open for media reader)																																																
Rear audio ports	Line-in (stereo, 3.5mm), line-out (stereo, 3.5mm), microphone (stereo, 3.5mm)																																																
Audio	High Definition (HD) Audio, Realtek® ALC662 codec																																																
Speaker	One internal speaker for business audio																																																
Ethernet	Gigabit ethernet on planar, Marvell® 88E8056, PCIe x1, Wake on LAN®																																																
Intel AMT	None																																																
Modem	None																																																
Security chip	None																																																
Keyboard	Preferred Pro USB Keyboard (USB connector), 104-key, black, Lenovo logo		Limited Warranty¹ <ul style="list-style-type: none"> ↔ 3-year parts and labor ↔ International Warranty Service⁹ ↔ Customer Replaceable Unit (CRU) parts only (with limited onsite service for selected parts³, 8 am - 5 pm, Mon - Fri coverage excluding holidays, next business day response time) ↔ Onsite service upgrade options (in eligible locations):⁷ <ul style="list-style-type: none"> • 3-year LOR 9x5, 4 hour response (ThinkPlus™ part number 41C9192) • 3-year LOR 24x7, 4 hour response (ThinkPlus part number 41C9193) • 4-year LOR 9x5, Next Business Day (ThinkPlus part number 41C9194) • 4-year LOR 9x5, 4 hour response (ThinkPlus part number 41C9195) • 4-year LOR 24x7, 4 hour response (ThinkPlus part number 41C9196) ↔ ThinkPlus services at lenovo.com/thinkplus/warranty ↔ Post warranty maintenance services available ↔ 24 hour x 7 day¹⁴ toll-free support during the warranty period¹ via 800-426-7378 																																														
Mouse	Optical Wheel Mouse (USB connector), 400 dpi, black, Lenovo logo																																																
Power supply	280 watts with variable speed fan, autosenesing																																																
Preloaded operating system²⁰	- Microsoft® Windows® XP Professional with Vista® COA ↕ Disk-to-Disk Recovery (in hidden protected area)		Accessories <table border="0"> <tr><td>1GB PC2-5300 CL5 NP DDR2 UDIMM</td><td>73P4984</td></tr> <tr><td>2GB PC2-5300 CL5 NP DDR2 UDIMM</td><td>73P4985</td></tr> <tr><td>1GB PC2-6400 NP DDR2 UDIMM</td><td>41U2977</td></tr> <tr><td>2GB PC2-6400 NP DDR2 UDIMM</td><td>41U2978</td></tr> <tr><td>250GB SATA 3.0Gb/s Disk (7200 rpm)</td><td>41N3015</td></tr> <tr><td>500GB SATA 3.0Gb/s Disk (7200 rpm)</td><td>43R1990</td></tr> <tr><td>USB Portable Diskette Drive</td><td>05K9276</td></tr> <tr><td>USB 2.0 Lenovo Multimedia Headset</td><td>40Y8518</td></tr> <tr><td>USB 2.0 Lenovo Webcam</td><td>40Y8519</td></tr> <tr><td>USB 2.0 Essential Memory Key 32GB</td><td>45K1258</td></tr> <tr><td>USB 2.0 Ultra Secure Memory Key 4GB</td><td>45J5917</td></tr> <tr><td>USB 2.0 Ultra Secure Memory Key 8GB</td><td>45J5918</td></tr> <tr><td>USB 2.0 Portable Secure 320GB Hard Disk</td><td>43R2019</td></tr> <tr><td>ThinkVision® L1940p Wide 19" Monitor</td><td>4424HB6</td></tr> <tr><td>ThinkVision L2240p Wide 22" Monitor</td><td>4422HB6</td></tr> <tr><td>ThinkVision L2440p Wide 24" Monitor</td><td>4420HB2</td></tr> <tr><td>Wireless Kbd & Opt Wheel Mouse (via USB)</td><td>73P4067</td></tr> <tr><td>Laser Tilt Wheel Mouse (USB, PS/2)</td><td>41U3074</td></tr> <tr><td>Kensington Cable Lock from Lenovo</td><td>73P2582</td></tr> <tr><td>ADD2 DVI-I PCIe Connection Adapter</td><td>73P2516</td></tr> <tr><td>ADD2 DVI-D Monitor Connection (HDPC)</td><td>43R1985</td></tr> <tr><td>ATI™ Radeon™ HD 2400 Pro 128MB</td><td>43R1961</td></tr> <tr><td>ATI Radeon HD 2400 XT 256MB</td><td>43R1962</td></tr> </table> Acc Guide in pdf lenovo.com/accessoriesguide Other accessories at lenovo.com/accessories	1GB PC2-5300 CL5 NP DDR2 UDIMM	73P4984	2GB PC2-5300 CL5 NP DDR2 UDIMM	73P4985	1GB PC2-6400 NP DDR2 UDIMM	41U2977	2GB PC2-6400 NP DDR2 UDIMM	41U2978	250GB SATA 3.0Gb/s Disk (7200 rpm)	41N3015	500GB SATA 3.0Gb/s Disk (7200 rpm)	43R1990	USB Portable Diskette Drive	05K9276	USB 2.0 Lenovo Multimedia Headset	40Y8518	USB 2.0 Lenovo Webcam	40Y8519	USB 2.0 Essential Memory Key 32GB	45K1258	USB 2.0 Ultra Secure Memory Key 4GB	45J5917	USB 2.0 Ultra Secure Memory Key 8GB	45J5918	USB 2.0 Portable Secure 320GB Hard Disk	43R2019	ThinkVision® L1940p Wide 19" Monitor	4424HB6	ThinkVision L2240p Wide 22" Monitor	4422HB6	ThinkVision L2440p Wide 24" Monitor	4420HB2	Wireless Kbd & Opt Wheel Mouse (via USB)	73P4067	Laser Tilt Wheel Mouse (USB, PS/2)	41U3074	Kensington Cable Lock from Lenovo	73P2582	ADD2 DVI-I PCIe Connection Adapter	73P2516	ADD2 DVI-D Monitor Connection (HDPC)	43R1985	ATI™ Radeon™ HD 2400 Pro 128MB	43R1961	ATI Radeon HD 2400 XT 256MB	43R1962
1GB PC2-5300 CL5 NP DDR2 UDIMM	73P4984																																																
2GB PC2-5300 CL5 NP DDR2 UDIMM	73P4985																																																
1GB PC2-6400 NP DDR2 UDIMM	41U2977																																																
2GB PC2-6400 NP DDR2 UDIMM	41U2978																																																
250GB SATA 3.0Gb/s Disk (7200 rpm)	41N3015																																																
500GB SATA 3.0Gb/s Disk (7200 rpm)	43R1990																																																
USB Portable Diskette Drive	05K9276																																																
USB 2.0 Lenovo Multimedia Headset	40Y8518																																																
USB 2.0 Lenovo Webcam	40Y8519																																																
USB 2.0 Essential Memory Key 32GB	45K1258																																																
USB 2.0 Ultra Secure Memory Key 4GB	45J5917																																																
USB 2.0 Ultra Secure Memory Key 8GB	45J5918																																																
USB 2.0 Portable Secure 320GB Hard Disk	43R2019																																																
ThinkVision® L1940p Wide 19" Monitor	4424HB6																																																
ThinkVision L2240p Wide 22" Monitor	4422HB6																																																
ThinkVision L2440p Wide 24" Monitor	4420HB2																																																
Wireless Kbd & Opt Wheel Mouse (via USB)	73P4067																																																
Laser Tilt Wheel Mouse (USB, PS/2)	41U3074																																																
Kensington Cable Lock from Lenovo	73P2582																																																
ADD2 DVI-I PCIe Connection Adapter	73P2516																																																
ADD2 DVI-D Monitor Connection (HDPC)	43R1985																																																
ATI™ Radeon™ HD 2400 Pro 128MB	43R1961																																																
ATI Radeon HD 2400 XT 256MB	43R1962																																																
Preloaded applications⁵	<ul style="list-style-type: none"> • Rescue and Recovery™ • Client Security Solution™ • ThinkVantage Productivity Center • ThinkVantage System Update • System Migration Assistant • Norton Internet Security™ (90 days of virus definitions) • Diskeeper® Home • PC-Doctor™ (diagnostics) • Adobe® Reader • Windows Live™ Toolbar • Windows Live Search • Picasa from Google • Microsoft Office 2007 Trial (60-day) • Multimedia Center for Think Offerings (DVD, DVD±RW) • Sonic RecordNow and Drive Letter Access (DVD±RW) • Corel® WinDVD® (DVD, DVD±RW) • Corel WinDVD Creator (DVD±RW) 																																																

See footnotes for important warranty information
 US models announced October 21, 2008

Name	Type-model	Slot x bay	Processor	GHz	L2 cache	Core	Memory ⁸	SATA disk	SATA optical	Graphics	Preload	Limited warranty ¹	Global Educ	Avail date
M57e	9482-BGU	2x3	Pentium E2160	1.80	1MB	Dual	1GB	160GB ²	DVD	GMA	XP Pro	3-yr		Mar 08
M57e	9482-BHU	2x3	Pentium E2160	1.80	1MB	Dual	1GB	160GB	Combo	GMA	XP Pro	3-yr		Mar 08
M57e	9482-BKU	2x3	Core 2 Duo E4500	2.20	2MB	Dual	1GB	160GB	DVD	GMA	XP Pro	3-yr		Mar 08
M57e	9482-BJU	2x3	Core 2 Duo E4500	2.20	2MB	Dual	1GB	160GB	Combo	GMA	XP Pro	3-yr		Mar 08
M57e	9482-BLU	2x3	Core 2 Duo E4500	2.20	2MB	Dual	1GB	160GB	Combo	GMA	XP Pro	3-yr	K12	Mar 08
M57e	9482-BMU	2x3	Core 2 Duo E4500	2.20	2MB	Dual	1GB	160GB	Combo	GMA	XP Pro	3-yr	HE	Mar 08
M57e	9482-BPU	2x3	Core 2 Duo E6550	2.33	4MB	Dual	1GB	160GB	DVD	GMA	XP Pro	3-yr		Mar 08
M57e	9482-BNU	2x3	Core 2 Duo E6550	2.33	4MB	Dual	1GB	160GB	Combo	GMA	XP Pro	3-yr		Mar 08
M57e	9482-DAU	2x3	Core 2 Duo E8200	2.66	6MB	Dual	1GB	160GB	Combo	GMA	XP Pro	3-yr		Mar 08

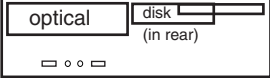
Positioning	Mainstream enterprise stability and manageability								Small					
Processor	Intel® Pentium® Dual-Core Processor E2160 with dual-core, Intel 64 Technology, Execute Disable Bit, EIST, 800MHz system bus, and 1MB shared L2 cache or Intel Core™ 2 Duo Processor E4500 with dual-core, Intel 64 Technology, Execute Disable Bit, EIST, 800MHz system bus, and 2MB shared L2 cache or Intel Core 2 Duo Processor E6550 with dual-core, Intel 64 Technology, Virtualization Technology, Execute Disable Bit, EIST, TXT, 1333MHz system bus, and 4MB shared L2 cache or Intel Core 2 Duo Processor E8200 with dual-core, Intel 64 Technology, Virtualization Technology, Execute Disable Bit, EIST, TXT, and 1333MHz system bus with 6MB shared L2 cache Processor in FC-LGA6 or FC-LGA8 package in LGA775 socket								 <p>Bay ① 5.25", 1.6" high, access, std optical Bay ② 3.5", 1" high, no access, std disk Bay ③ 3.5", .5" high, access, open (reader/diskette)</p> <p>Slot 1: Low Profile, PCI Express x16 (35w max) Slot 2: Low Profile, 32-bit PCI 2.3</p> <ul style="list-style-type: none"> • Business black color; metal case • 12.5" W X 14.0" D X 3.9" H • 317mm W X 355mm D X 99mm H • 16.1 lb (7.3 kg) in maximum configuration • Bays 1, 2, 3 flip up (latched and pivoting) • Toolless cover flips up and tilts backward on rear hinges • Toolless disk, diskette drive, optical drive removal • Toolless adapter retention • Toolless systemboard retention • Steel chassis supports 100 lb (45kg) monitor on top • System floor stand for vertical orientation 					
Implementation	Processor in FC-LGA6 or FC-LGA8 package in LGA775 socket													
Memory	1GB std, 4GB max⁸, PC2-5300 667MHz DDR2, non-parity, dual-channel capable, two 240-pin DIMM sockets; <i>Non-italics:</i> standard memory in one socket; one socket available													
Graphics	Intel Graphics Media Accelerator 3100 (GMA 3100), integrated graphics in G31, uses main memory (up to 256MB), one analog VGA DB-15 connector, supports dual independent display with optional ADD2 adapter													
SATA disk	160GB, SATA 3.0Gb/s 7200 rpm, vibration dampening mounts													
SATA controller	Serial ATA, SATA 3.0Gb/s, integrated in ICH7													
SATA DVD	<i>Some:</i> DVD-ROM DL SATA 1.5Gb/s 16-48X Max ⁴ Drive (41N5618)													
SATA Combo	<i>Some:</i> CD-RW/DVD-ROM Combo SATA 1.5Gb/s Drive													
SATA cables	Two SATA cables (each 1-drop to device), two SATA connectors on planar													
eSATA port	None													
EIDE controller	Enhanced IDE, ATA-100, integrated in ICH7, one EIDE connector on planar													
Diskette drive	None													
Media reader	None													
Chipset	Intel G31 Express Chipset; I/O Controller Hub 7 (ICH7) for SATA 3.0Gb/s, ATA-100 EIDE, PCI Express [®] x1, PCI 2.3, USB, LPC bus / ITE Tech [®] IT8718 Super I/O for serial, parallel, keyboard, mouse functions								Security <ul style="list-style-type: none"> • Security slot (in rear for attachment of optional Kensington[®] Microsaver[®] cable) - optional cable also locks the cover by deactivating the cover release buttons • Power-on password • Administrator password • Hard disk password • Boot sequence control • Boot without keyboard, mouse, diskette • Serial port I/O control • Parallel port I/O control • USB port disablement 					
Front ports	Two USB 2.0, microphone (stereo, 3.5mm), headphone (stereo, 3.5mm)													
Rear ports	Four USB 2.0, serial (9-pin), parallel (25-pin), keyboard (PS/2), mouse (PS/2), ethernet (RJ-45), monitor (VGA DB-15)													
Internal connector	Two USB 2.0 planar connectors (one used; one open for media reader)													
Rear audio ports	Line-in (stereo, 3.5mm), line-out (stereo, 3.5mm), microphone (stereo, 3.5mm)													
Audio	High Definition (HD) Audio, Realtek [®] ALC662 codec													
Speaker	One internal speaker for business audio													
Ethernet	Gigabit ethernet on planar, Marvell [®] 88E8056, PCIe x1, Wake on LAN [®]													
Intel AMT	None													
Modem	None													
Security chip	None													
Keyboard	Preferred Pro USB Keyboard (USB connector), 104-key, black, Lenovo logo													
Mouse	Optical Wheel Mouse (USB connector), 400 dpi, black, Lenovo logo													
Power supply	280 watts with variable speed fan, autosenesing													

Preloaded operating system²⁰ - Microsoft [®] Windows [®] XP Professional with Vista [®] COA ✦ Disk-to-Disk Recovery (in hidden protected area)	Accessories 1GB PC2-5300 CL5 NP DDR2 UDIMM 73P4984 2GB PC2-5300 CL5 NP DDR2 UDIMM 73P4985 1GB PC2-6400 NP DDR2 UDIMM 41U2977 2GB PC2-6400 NP DDR2 UDIMM 41U2978 500GB SATA 3.0Gb/s Disk (7200 rpm) 43R1990 USB 2.0 Lenovo Multimedia Headset 40Y8518 USB 2.0 Essential Memory Key 32GB 45K1258 USB 2.0 Ultra Secure Memory Key 8GB 45J5918 USB 2.0 Portable Secure 320GB Hard Disk 43R2019 Super Multi-Burner DL DVD±RW SATA Drive 41N5620 ThinkVision [®] L2440p Wide 24" Monitor 4420HB2 Wireless Kbd & Opt Wheel Mouse (via USB) 73P4067 Kensington Cable Lock from Lenovo 73P2582 ADD2 DVI-I PCIe Connection Adapter 73P2516 ADD2 DVI-D Monitor Connection (HDCP) 43R1985 ATI [™] Radeon [™] HD 2400 Pro 128MB 43R1961 ATI Radeon HD 2400 XT 256MB 43R1962 Acc Guide in pdf lenovo.com/accessoriesguide Other accessories at lenovo.com/accessories	Limited Warranty¹ ⇨ 3-year parts and labor ⇨ International Warranty Service⁹ ⇨ Customer Replaceable Unit (CRU) parts only (with limited onsite service for selected parts³, 8 am - 5 pm, Mon - Fri coverage excluding holidays, next business day response time) ⇨ Onsite service upgrade options (in eligible locations):⁷ <ul style="list-style-type: none"> • 3-year LOR 9x5, 4 hour response (ThinkPlus[™] part number 41C9192) • 3-year LOR 24x7, 4 hour response (ThinkPlus part number 41C9193) • 4-year LOR 9x5, Next Business Day (ThinkPlus part number 41C9194) • 4-year LOR 9x5, 4 hour response (ThinkPlus part number 41C9195) • 4-year LOR 24x7, 4 hour response (ThinkPlus part number 41C9196) ⇨ ThinkPlus services at lenovo.com/thinkplus/warranty ⇨ Post warranty maintenance services available ⇨ 24 hour x 7 day¹⁴ toll-free support during the warranty period¹ via 800-426-7378
---	---	---

See footnotes for important warranty information

Ⓜ US models announced March 18, 2008; previous models on February 26, 2008

Ⓜ US models withdrawn effective September 2008

Name	Type-model	Slot x bay	Processor	GHz	L2 cache	Core	Memory ⁶	SATA disk	SATA optical	Graphics	Preload	Limited warranty ¹	Global Educ	Avail date
M57e	9482-HJU	2x3	Pentium E2180	2.00	1MB	Dual	1GB	160GB ²	DVD	GMA	XP Pro	3-yr	None	Sep 08
M57e	9482-HKU	2x3	Pentium E2200	2.20	1MB	Dual	1GB	160GB	DVD	GMA	XP Pro	3-yr	None	Sep 08
M57e	9482-HLU	2x3	Pentium E2200	2.20	1MB	Dual	2GB	160GB	DVD±RW	GMA	XP Pro	3-yr	None	Sep 08
M57e	9482-HHU	2x3	Core 2 Duo E7200	2.53	3MB	Dual	2GB	160GB	DVD	GMA	XP Pro	3-yr	None	Sep 08
M57e	9482-HFU	2x3	Core 2 Duo E7300	2.66	3MB	Dual	1GB	160GB	DVD±RW	GMA+ADD2	XP Pro	3-yr	None	Sep 08
M57e	9482-HGU	2x3	Core 2 Duo E7300	2.66	3MB	Dual	2GB	160GB	DVD	GMA	XP Pro	3-yr	None	Sep 08

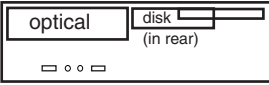
Positioning Processor	<i>Mainstream enterprise stability and manageability</i> Intel® Pentium® Dual-Core Processor E2180 or E2200 with dual-core, Intel 64 Technology, Execute Disable Bit, EIST, 800MHz system bus, and 1MB L2 cache or Intel Core™ 2 Duo Processor E7200 or E7300 with dual-core, Intel 64 Technology, Execute Disable Bit, EIST, and 1066MHz system bus with 3MB L2 cache	Small  Bay ① 5.25", 1.6" high, access, std optical Bay ② 3.5", 1" high, no access, std disk Bay ③ 3.5", .5" high, access, open (reader/diskette)
Implementation	Processor in FC-LGA6 or FC-LGA8 package in LGA775 socket	
Memory	1GB or 2GB std, 4GB max⁸, PC2-5300 667MHz DDR2 , non-parity, dual-channel capable, two 240-pin DIMM sockets; <i>Non-italics</i> : standard memory in one socket; one socket available	Slot 1: Low Profile, PCI Express x16 (35w max)* Slot 2: Low Profile, 32-bit PCI 2.3 * used in some models
Graphics	<i>All:</i> Intel Graphics Media Accelerator 3100 (GMA 3100) , integrated graphics in G31, uses main memory (up to 256MB), one analog VGA DB-15 connector <i>Some:</i> ADD2 DVI-D Monitor Connection (HDCP) , PCI Express® adapter in PCIe x16 slot, provides DVI-D connector to support second monitor, HDCP-compliant	<ul style="list-style-type: none"> • Business black color; metal case • 12.5" W X 14.0" D X 3.9" H • 317mm W X 355mm D X 99mm H • 16.1 lb (7.3 kg) in maximum configuration • Bays 1, 2, 3 flip up (latched and pivoting) • Toolless cover flips up and tilts backward on rear hinges • Toolless disk, diskette drive, optical drive removal • Toolless adapter retention • Toolless systemboard retention • Steel chassis supports 100 lb (45kg) monitor on top • System floor stand for vertical orientation
SATA disk	160GB , SATA 3.0Gb/s 7200 rpm, vibration dampening mounts	Security <ul style="list-style-type: none"> • Security slot (in rear for attachment of optional Kensington® Microsaver® cable) - optional cable also locks the cover by deactivating the cover release buttons • Power-on password • Administrator password • Hard disk password • Boot sequence control • Boot without keyboard, mouse, diskette • Serial port I/O control • Parallel port I/O control • USB port disablement Supports ThinkVantage® technologies RoHS-compliant
SATA controller	Serial ATA, SATA 3.0Gb/s, integrated in ICH7	
SATA DVD	<i>Some:</i> DVD-ROM DL SATA 1.5Gb/s 16-48X Max ⁴ Drive (41N5618)	
SATA DVD±RW	<i>Some:</i> Super Multi-Burner DL DVD±RW SATA Drive (41N5620)	
SATA cables	Two SATA cables (each 1-drop to device), two SATA connectors	
eSATA port	None	
EIDE controller	Enhanced IDE, ATA-100, integrated in ICH7, one EIDE connector on planar	
Diskette drive	None	
Media reader	None	
Chipset	Intel G31 Express Chipset ; I/O Controller Hub 7 (ICH7) for SATA 3.0Gb/s, ATA-100 EIDE, PCI Express x1, PCI 2.3, USB, LPC bus / ITE Tech® IT8718 Super I/O for serial, parallel, keyboard, mouse functions	
Front ports	Two USB 2.0, microphone (stereo, 3.5mm), headphone (stereo, 3.5mm)	
Rear ports	Four USB 2.0, serial (9-pin), parallel (25-pin), keyboard (PS/2), mouse (PS/2), ethernet (RJ-45), monitor (VGA DB-15, DVI-D in some models)	
Internal connector	Two USB 2.0 planar connectors (one used; one open for media reader)	
Rear audio ports	Line-in (stereo, 3.5mm), line-out (stereo, 3.5mm), microphone (stereo, 3.5mm)	
Audio	High Definition (HD) Audio, Realtek® ALC662 codec	
Speaker	One internal speaker for business audio	
Ethernet	Gigabit ethernet on planar, Marvell® 88E8056, PCIe x1, Wake on LAN®	
Intel AMT	None	
Modem	None	
Security chip	None	
Keyboard	Preferred Pro USB Keyboard (USB connector), 104-key, black, Lenovo logo	
Mouse	Optical Wheel Mouse (USB connector), 400 dpi, black, Lenovo logo	
Power supply	280 watts with variable speed fan, autosensing	

Preloaded operating system²⁰ - Microsoft® Windows® XP Professional with Vista® COA ⇨ Disk-to-Disk Recovery (in hidden protected area) Preloaded applications⁵ <ul style="list-style-type: none"> • Rescue and Recovery™ • Client Security Solution™ • ThinkVantage Productivity Center • ThinkVantage System Update • System Migration Assistant • Norton Internet Security™ (90 days of virus definitions) • Diskkeeper® Home • PC-Doctor™ (diagnostics) • Adobe® Reader • Windows Live™ Toolbar • Windows Live Search • Picasa from Google • Microsoft Office 2007 Trial (60-day) • Multimedia Center for Think Offerings (DVD, DVD±RW) • Sonic RecordNow and Drive Letter Access (DVD±RW) • Corel® WinDVD® (DVD, DVD±RW) • Corel WinDVD Creator (DVD±RW) 	Accessories <ul style="list-style-type: none"> 1GB PC2-5300 CL5 NP DDR2 UDIMM 73P4984 2GB PC2-5300 CL5 NP DDR2 UDIMM 73P4985 1GB PC2-6400 NP DDR2 UDIMM 41U2977 2GB PC2-6400 NP DDR2 UDIMM 41U2978 250GB SATA 3.0Gb/s Disk (7200 rpm) 41N3015 500GB SATA 3.0Gb/s Disk (7200 rpm) 43R1990 USB Portable Diskette Drive 05K9276 USB 2.0 Lenovo Multimedia Headset 40Y8518 USB 2.0 Lenovo Webcam 40Y8519 USB 2.0 Essential Memory Key 32GB 45K1258 USB 2.0 Ultra Secure Memory Key 2GB 45J5916 USB 2.0 Ultra Secure Memory Key 4GB 45J5917 USB 2.0 Ultra Secure Memory Key 8GB 45J5918 USB 2.0 Portable Secure 320GB Hard Disk 43R2019 ThinkVision® L2240p Wide 22" Monitor 4422HBB ThinkVision L2440p Wide 24" Monitor 4420HBB Wireless Kbd & Opt Wheel Mouse (via USB) 73P4067 Laser Tilt Wheel Mouse (USB, PS/2) 41U3074 Kensington Cable Lock from Lenovo 73P2582 ADD2 DVI-I PCIe Connection Adapter 73P2516 ADD2 DVI-D Monitor Connection (HDCP) 43R1985 ATI™ Radeon™ HD 2400 Pro 128MB 43R1961 ATI Radeon HD 2400 XT 256MB 43R1962 Acc Guide in pdf lenovo.com/accessoriesguide Other accessories at lenovo.com/accessories 	Limited Warranty¹ <ul style="list-style-type: none"> ⇨ 3-year parts and labor ⇨ International Warranty Service⁹ ⇨ Customer Replaceable Unit (CRU) parts only (with limited onsite service for selected parts³, 8 am - 5 pm, Mon - Fri coverage excluding holidays, next business day response time) ⇨ Onsite service upgrade options (in eligible locations):⁷ <ul style="list-style-type: none"> • 3-year LOR 9x5, 4 hour response (ThinkPlus™ part number 41C9192) • 3-year LOR 24x7, 4 hour response (ThinkPlus part number 41C9193) • 4-year LOR 9x5, Next Business Day (ThinkPlus part number 41C9194) • 4-year LOR 9x5, 4 hour response (ThinkPlus part number 41C9195) • 4-year LOR 24x7, 4 hour response (ThinkPlus part number 41C9196) ⇨ ThinkPlus services at lenovo.com/thinkplus/warranty ⇨ Post warranty maintenance services available ⇨ 24 hour x 7 day¹⁴ toll-free support during the warranty period¹ via 800-426-7378
---	--	---

See footnotes for important warranty information
 US models announced August 19, 2008

Name	Type-model	Slot x bay	Processor	GHz	L2 cache	Core	Memory ⁸	SATA disk	SATA optical	Graphics	Vista preload	Limited warranty ¹	Global Educ	Avail date
M57e	9482-AUU	2x3	Celeron 420	1.60	512KB	Single	1GB	160GB ²	DVD	GMA	Bus32	3-yr	None	Mar 08
M57e	9482-AAU	2x3	Celeron 430	1.80	512KB	Single	1GB	80GB	DVD	GMA	Bus32	3-yr	None	Mar 08
M57e	9482-ABU	2x3	Pentium E2160	1.80	1MB	Dual	1GB	80GB	DVD	GMA	Bus32	3-yr	None	Mar 08
M57e	9482-ACU	2x3	Pentium E2160	1.80	1MB	Dual	1GB	80GB	Combo	GMA	Bus32	3-yr	None	Mar 08
M57e	9482-AVU	2x3	Pentium E2160	1.80	1MB	Dual	1GB	160GB	DVD	GMA	Bus32	3-yr	None	Mar 08
M57e	9482-AWU	2x3	Pentium E2160	1.80	1MB	Dual	1GB	160GB	Combo	GMA	Bus32	3-yr	None	Mar 08
M57e	9482-ADU	2x3	Core 2 Duo E4500	2.20	2MB	Dual	1GB	80GB	DVD	GMA	Bus32	3-yr	None	Mar 08
M57e	9482-AEU	2x3	Core 2 Duo E4500	2.20	2MB	Dual	1GB	80GB	Combo	GMA	Bus32	3-yr	None	Mar 08
M57e	9482-B1U	2x3	Core 2 Duo E4500	2.20	2MB	Dual	1GB	160GB	DVD	GMA	Bus32	3-yr	None	Mar 08
M57e	9482-B2U	2x3	Core 2 Duo E4500	2.20	2MB	Dual	1GB	160GB	Combo	GMA	Bus32	3-yr	None	Mar 08
M57e	9482-AFU	2x3	Core 2 Duo E6550	2.33	4MB	Dual	1GB	80GB	Combo	GMA	Bus32	3-yr	None	Mar 08
M57e	9482-AGU	2x3	Core 2 Duo E6550	2.33	4MB	Dual	1GB	80GB	DVD±RW	GMA	Bus32	3-yr	None	Mar 08
M57e	9482-B6U	2x3	Core 2 Duo E6550	2.33	4MB	Dual	1GB	160GB	DVD	GMA	Bus32	3-yr	None	Mar 08
M57e	9482-B5U	2x3	Core 2 Duo E6550	2.33	4MB	Dual	1GB	160GB	Combo	GMA	Bus32	3-yr	None	Mar 08

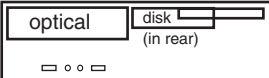
Positioning	<i>Mainstream enterprise stability and manageability</i>																											
Processor	<p>Intel® Celeron® Processor 420 or 430 with single-core, Intel 64 Technology, EDBit, 800MHz bus, and 512KB L2 cache or</p> <p>Intel Pentium® Dual-Core Processor E2160 with dual-core, Intel 64 Technology, Execute Disable Bit, EIST, 800MHz system bus, and 1MB shared L2 cache or</p> <p>Intel Core™ 2 Duo Processor E4500 with dual-core, Intel 64 Technology, Execute Disable Bit, EIST, 800MHz system bus, and 2MB shared L2 cache or</p> <p>Intel Core 2 Duo Processor E6550 with dual-core, Intel 64 Technology, Virtualization Technology, Execute Disable Bit, EIST, TXT, and 1333MHz system bus with 4MB shared L2 cache Processor in FC-LGA6 package in LGA775 socket</p>	<p>Small</p>  <p>Bay ① 5.25", 1.6" high, access, std optical Bay ② 3.5", 1" high, no access, std disk Bay ③ 3.5", .5" high, access, open (reader/diskette)</p> <p>Slot 1: Low Profile, PCI Express x16 (35w max) Slot 2: Low Profile, 32-bit PCI 2.3</p> <ul style="list-style-type: none"> • Business black color; metal case • 12.5" W X 14.0" D X 3.9" H • 317mm W X 355mm D X 99mm H • 16.1 lb (7.3 kg) in maximum configuration • Bays 1, 2, 3 flip up (latched and pivoting) • Toolless cover flips up and tilts backward on rear hinges • Toolless disk, diskette drive, optical drive removal • Toolless adapter retention • Toolless systemboard retention • Steel chassis supports 100 lb (45kg) monitor on top • System floor stand for vertical orientation 																										
Implementation																												
Memory	<p>1GB std, 4GB max⁸, PC2-5300 667MHz DDR2, non-parity, dual-channel capable, two 240-pin DIMM sockets; <i>Non-italics</i>: standard memory in one socket; one socket available</p>																											
Graphics	<p>Intel Graphics Media Accelerator 3100 (GMA 3100), integrated graphics in G31, uses main memory (up to 256MB), one analog VGA DB-15 connector, supports dual independent display with optional ADD2 adapter</p>																											
SATA disk	<p>80GB or 160GB, SATA 3.0Gb/s 7200 rpm, vibration dampening</p>																											
SATA controller	Serial ATA, SATA 3.0Gb/s, integrated in ICH7																											
SATA DVD	<p><i>Some</i>: DVD-ROM DL SATA 1.5Gb/s 16-48X Max⁴ Drive (41N5618)</p>																											
SATA Combo	<p><i>Some</i>: CD-RW/DVD-ROM Combo SATA 1.5Gb/s Drive</p>																											
SATA DVD±RW	<p><i>Some</i>: Super Multi-Burner DL DVD±RW SATA 1.5Gb/s Drive (41N5620)</p>																											
SATA cables	Two SATA cables (each 1-drop to device), two SATA connectors on planar																											
eSATA port	None																											
EIDE controller	Enhanced IDE, ATA-100, integrated in ICH7, one EIDE connector on planar																											
Diskette drive	None																											
Media reader	None																											
Chipset	<p>Intel G31 Express Chipset; I/O Controller Hub 7 (ICH7) for SATA 3.0Gb/s, ATA-100 EIDE, PCI Express[®] x1, PCI 2.3, USB, LPC bus /</p> <p>ITE Tech[®] IT8718 Super I/O for serial, parallel, keyboard, mouse functions</p>																											
Front ports	Two USB 2.0, microphone (stereo, 3.5mm), headphone (stereo, 3.5mm)																											
Rear ports	Four USB 2.0, serial (9-pin), parallel (25-pin), keyboard (PS/2), mouse (PS/2), ethernet (RJ-45), monitor (VGA DB-15)																											
Internal connector	Two USB 2.0 planar connectors (one used; one open for media reader)																											
Rear audio ports	Line-in (stereo, 3.5mm), line-out (stereo, 3.5mm), microphone (stereo, 3.5mm)																											
Audio	High Definition (HD) Audio, Realtek [®] ALC662 codec																											
Speaker	One internal speaker for business audio																											
Ethernet	Gigabit ethernet on planar, Marvell [®] 88E8056, PCIe x1, Wake on LAN [®]																											
Intel AMT	None																											
Modem	None																											
Security chip	None																											
Keyboard	Preferred Pro USB Keyboard (USB connector), 104-key, black, Lenovo logo																											
Mouse	Optical Wheel Mouse (USB connector), 400 dpi, black, Lenovo logo																											
Power supply	280 watts with variable speed fan, autosenesing																											
Preloaded operating system²⁰	<p>- Microsoft[®] Windows[®] Vista Business Edition (32-bit)</p> <p>◇ Vista Basic logo</p>																											
Preloaded applications⁵ (only some listed)	<ul style="list-style-type: none"> • Rescue and Recovery[™] • Client Security Solution[™] • ThinkVantage Productivity Center • ThinkVantage System Update • Norton Internet Security[™] • Diskeeper[®] Home • Microsoft Office 2007 Trial (60-day) • Sonic RecordNow and Drive Letter Access (combo, DVD±RW) • Corel[®] WinDVD[®] (combo, DVD, DVD±RW) 	<p>Accessories</p> <table border="0"> <tr> <td>1GB PC2-5300 CL5 NP DDR2 UDIMM</td> <td>73P4984</td> </tr> <tr> <td>2GB PC2-5300 CL5 NP DDR2 UDIMM</td> <td>73P4985</td> </tr> <tr> <td>1GB PC2-6400 NP DDR2 UDIMM</td> <td>41U2977</td> </tr> <tr> <td>2GB PC2-6400 NP DDR2 UDIMM</td> <td>41U2978</td> </tr> <tr> <td>500GB SATA 3.0Gb/s Disk (7200 rpm)</td> <td>43R1990</td> </tr> <tr> <td>USB 2.0 Lenovo Multimedia Headset</td> <td>40Y8518</td> </tr> <tr> <td>ThinkVision[®] L2440p Wide 24" Monitor</td> <td>4420HB2</td> </tr> <tr> <td>Wireless Kbd & Opt Wheel Mouse (via USB)</td> <td>73P4067</td> </tr> <tr> <td>Kensington Cable Lock from Lenovo</td> <td>73P2582</td> </tr> <tr> <td>ADD2 DVI-I PCIe Connection Adapter</td> <td>73P2516</td> </tr> <tr> <td>ADD2 DVI-D Monitor Connection (HDCP)</td> <td>43R1985</td> </tr> <tr> <td>ATI[™] Radeon[™] HD 2400 Pro 128MB</td> <td>43R1961</td> </tr> <tr> <td>ATI Radeon HD 2400 XT 256MB</td> <td>43R1962</td> </tr> </table> <p>Other accessories at lenovo.com/accessories</p>	1GB PC2-5300 CL5 NP DDR2 UDIMM	73P4984	2GB PC2-5300 CL5 NP DDR2 UDIMM	73P4985	1GB PC2-6400 NP DDR2 UDIMM	41U2977	2GB PC2-6400 NP DDR2 UDIMM	41U2978	500GB SATA 3.0Gb/s Disk (7200 rpm)	43R1990	USB 2.0 Lenovo Multimedia Headset	40Y8518	ThinkVision [®] L2440p Wide 24" Monitor	4420HB2	Wireless Kbd & Opt Wheel Mouse (via USB)	73P4067	Kensington Cable Lock from Lenovo	73P2582	ADD2 DVI-I PCIe Connection Adapter	73P2516	ADD2 DVI-D Monitor Connection (HDCP)	43R1985	ATI [™] Radeon [™] HD 2400 Pro 128MB	43R1961	ATI Radeon HD 2400 XT 256MB	43R1962
1GB PC2-5300 CL5 NP DDR2 UDIMM	73P4984																											
2GB PC2-5300 CL5 NP DDR2 UDIMM	73P4985																											
1GB PC2-6400 NP DDR2 UDIMM	41U2977																											
2GB PC2-6400 NP DDR2 UDIMM	41U2978																											
500GB SATA 3.0Gb/s Disk (7200 rpm)	43R1990																											
USB 2.0 Lenovo Multimedia Headset	40Y8518																											
ThinkVision [®] L2440p Wide 24" Monitor	4420HB2																											
Wireless Kbd & Opt Wheel Mouse (via USB)	73P4067																											
Kensington Cable Lock from Lenovo	73P2582																											
ADD2 DVI-I PCIe Connection Adapter	73P2516																											
ADD2 DVI-D Monitor Connection (HDCP)	43R1985																											
ATI [™] Radeon [™] HD 2400 Pro 128MB	43R1961																											
ATI Radeon HD 2400 XT 256MB	43R1962																											
		<p>Security</p> <ul style="list-style-type: none"> • Security slot (in rear for attachment of optional Kensington[®] Microsaver[®] cable) - optional cable also locks the cover by deactivating the cover release buttons • Power-on password • Administrator password • Hard disk password • Boot sequence control • Boot without keyboard, mouse, diskette • Serial port I/O control • Parallel port I/O control • USB port disablement <p>Supports ThinkVantage[®] technologies</p> <p>RoHS-compliant</p> <p>Limited Warranty¹</p> <ul style="list-style-type: none"> ⇒ 3-year parts and labor ⇒ Customer Replaceable Unit (CRU) parts only (with limited onsite service for selected parts³, 8 am - 5 pm, Mon - Fri coverage excluding holidays, next business day response time) ⇒ Onsite service upgrade options (in eligible locations):⁷ <ul style="list-style-type: none"> • 3-year LOR 9x5, 4 hour response (ThinkPlus[™] part number 41C9192) • 3-year LOR 24x7, 4 hour response (ThinkPlus part number 41C9193) • 4-year LOR 9x5, Next Business Day (ThinkPlus part number 41C9194) • 4-year LOR 9x5, 4 hour response (ThinkPlus part number 41C9195) • 4-year LOR 24x7, 4 hour response (ThinkPlus part number 41C9196) ⇒ ThinkPlus services at lenovo.com/thinkplus/warranty ⇒ Post warranty maintenance services available ⇒ 24 hour x 7 day¹⁴ toll-free support during the warranty period¹ 																										

See footnotes for important warranty information
 US models announced February 19, 2008
 ⚡ US models withdrawn effective September 2008

ThinkCentre® M57e Small (9482) - Vista® (March 2008)

Personal Systems Reference (PSREF)

Name	Type-model	Slot x bay	Processor	GHz	L2 cache	Core	Memory ⁶	SATA disk	SATA optical	Graphics	Floor stand	Vista preload	Vista logo	Global Educ	Avail date
Ⓜ	M57e 9482-B8U	2x3	Pentium E2180	2.00	1MB	Dual	1GB	160GB ²	DVD±RW	GMA	Stand	Bus32	Basic	Gbl	Sep 08
	M57e 9482-E9U	2x3	Pentium E2200	2.20	1MB	Dual	1GB	160GB	Combo	GMA	Stand	Bus32	Basic	Gbl	Mar 08
ⓧ	M57e 9482-FLU	2x3	Core 2 Duo E4500	2.20	2MB	Dual	1GB	160GB	Combo	GMA	Stand	Bus32	Basic	Gbl	Apr 08
	M57e 9482-FAU	2x3	Core 2 Duo E4600	2.40	2MB	Dual	1GB	160GB	Combo	GMA+ADD2		Bus32	Basic	Gbl	Mar 08
	M57e 9482-DBU	2x3	Core 2 Duo E8200	2.66	6MB	Dual	1GB	160GB	Combo	GMA	Stand	Bus32	Basic	Gbl	Mar 08
	M57e 9482-FBU	2x3	Core 2 Duo E8400	3.00	6MB	Dual	2GB	250GB	DVD±RW	GMA+ADD2		Bus32	Prem	Gbl	Mar 08

• **These models have a 3-year limited warranty¹**

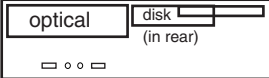
Positioning Processor	Mainstream enterprise stability and manageability Intel® Pentium® Dual-Core Processor E2180 or E2200 with dual-core, Intel 64 Technology, Execute Disable Bit, EIST, 800MHz system bus, and 1MB shared L2 cache or Intel Core™ 2 Duo Processor E4500 or E4600 with dual-core, Intel 64 Technology, Execute Disable Bit, EIST, 800MHz system bus, and 2MB shared L2 cache or Intel Core 2 Duo Processor E8200 or E8400 with dual-core, Intel 64 Technology, Virtualization Technology, Execute Disable Bit, EIST, TXT, and 1333MHz system bus with 6MB shared L2 cache Processor in FC-LGA6 or FC-LGA8 package in LGA775 socket		Small  Bay ① 5.25", 1.6" high, access, std optical Bay ② 3.5", 1" high, no access, std disk Bay ③ 3.5", .5" high, access, open (reader/diskette)
Implementation	Processor in FC-LGA6 or FC-LGA8 package in LGA775 socket		Slot 1: Low Profile, PCI Express x16 (35w max)* Slot 2: Low Profile, 32-bit PCI 2.3 * used in some models
Memory	1GB or 2GB std , 4GB max ⁸ , PC2-5300 667MHz DDR2 , non-parity, dual-channel capable, two 240-pin DIMM sockets; <i>Italics:</i> standard memory in both sockets; no sockets avail; <i>Non-italics:</i> standard memory in one socket; one socket available		<ul style="list-style-type: none"> • Business black color; metal case • 12.5" W X 14.0" D X 3.9" H • 317mm W X 355mm D X 99mm H • 16.1 lb (7.3 kg) in maximum configuration • Bays 1, 2, 3 flip up (latched and pivoting) • Toolless cover flips up and tilts backward on rear hinges • Toolless disk, diskette drive, optical drive removal • Toolless adapter retention • Toolless systemboard retention • Steel chassis supports 100 lb (45kg) monitor on top • <i>Some:</i> system floor stand for vertical orientation
Graphics	<i>All:</i> Intel Graphics Media Accelerator 3100 (GMA 3100) , integrated graphics in G31, uses main memory (up to 256MB), one analog VGA DB-15 connector <i>Some:</i> ADD2 DVI-I PCIe Connection Adapter , PCI Express [®] adapter in PCIe x16 slot, provides DVI-I connector to support second monitor, no DVI-to-VGA dongle		Security <ul style="list-style-type: none"> • Security slot (in rear for attachment of optional Kensington® Microsaver® cable) - optional cable also locks the cover by deactivating the cover release buttons • Power-on password • Administrator password • Hard disk password • Boot sequence control • Boot without keyboard, mouse, diskette • Serial port I/O control • Parallel port I/O control • USB port disablement
SATA disk	160GB or 250GB , SATA 3.0Gb/s 7200 rpm, vibration dampening		Supports ThinkVantage® technologies RoHS-compliant Limited Warranty¹ ⇨ 3-year parts and labor ⇨ Customer Replaceable Unit (CRU) parts only (with limited onsite service for selected parts³, 8 am - 5 pm, Mon - Fri coverage excluding holidays, next business day response time) ⇨ Onsite service upgrade options (in eligible locations):⁷ <ul style="list-style-type: none"> • 3-year LOR 9x5, 4 hour response (ThinkPlus™ part number 41C9192) • 3-year LOR 24x7, 4 hour response (ThinkPlus part number 41C9193) • 4-year LOR 9x5, Next Business Day (ThinkPlus part number 41C9194) • 4-year LOR 9x5, 4 hour response (ThinkPlus part number 41C9195) • 4-year LOR 24x7, 4 hour response (ThinkPlus part number 41C9196) ⇨ ThinkPlus services at lenovo.com/thinkplus/warranty ⇨ Post warranty maintenance services available ⇨ 24 hour x 7 day¹⁴ toll-free support during the warranty period¹ via 800-426-7378
SATA controller	Serial ATA, SATA 3.0Gb/s, integrated in ICH7		
SATA Combo	<i>Some:</i> CD-RW/DVD-ROM Combo SATA 1.5Gb/s Drive		
SATA DVD±RW	<i>Some:</i> Super Multi-Burner DL DVD±RW SATA 1.5Gb/s Drive (41N5620)		
SATA cables	Two SATA cables (each 1-drop to device), two SATA connectors on planar		
eSATA port	None		
EIDE controller	Enhanced IDE, ATA-100, integrated in ICH7, one EIDE connector on planar		
Diskette drive	None		
Media reader	None		
Chipset	Intel G31 Express Chipset ; I/O Controller Hub 7 (ICH7) for SATA 3.0Gb/s, ATA-100 EIDE, PCI Express x1, PCI 2.3, USB, LPC bus / ITE Tech® IT8718 Super I/O for serial, parallel, keyboard, mouse functions		
Front ports	Two USB 2.0, microphone (stereo, 3.5mm), headphone (stereo, 3.5mm)		
Rear ports	Four USB 2.0, serial (9-pin), parallel (25-pin), keyboard (PS/2), mouse (PS/2), ethernet (RJ-45), monitor (VGA DB-15, DVI-I in some models)		
Internal connector	Two USB 2.0 planar connectors (one used; one open for media reader)		
Rear audio ports	Line-in (stereo, 3.5mm), line-out (stereo, 3.5mm), microphone (stereo, 3.5mm)		
Audio	High Definition (HD) Audio, Realtek® ALC662 codec		
Speaker	One internal speaker for business audio		
Ethernet	Gigabit ethernet on planar, Marvell® 88E8056, PCIe x1, Wake on LAN®		
Intel AMT	None		
Modem	None		
Security chip	None		
Keyboard	Preferred Pro USB Keyboard (USB connector), 104-key, black, Lenovo logo		
Mouse	Optical Wheel Mouse (USB connector), 400 dpi, black, Lenovo logo		
Power supply	280 watts with variable speed fan, autosensing		
Preloaded operating system²⁰	Accessories 1GB PC2-5300 CL5 NP DDR2 UDIMM 73P4984 2GB PC2-5300 CL5 NP DDR2 UDIMM 73P4985 1GB PC2-6400 NP DDR2 UDIMM 41U2977 2GB PC2-6400 NP DDR2 UDIMM 41U2978 500GB SATA 3.0Gb/s Disk (7200 rpm) 43R1990 USB 2.0 Lenovo Multimedia Headset 40Y8518 USB 2.0 Lenovo Webcam 40Y8519 USB 2.0 Essential Memory Key 32GB 45K1258 USB 2.0 Ultra Secure Memory Key 8GB 45J5918 USB 2.0 Portable Secure 320GB Hard Disk 43R2019 ThinkVision® L1940p Wide 19" Monitor 4424HB6 ThinkVision L2240p Wide 22" Monitor 4422HB6 ThinkVision L2440p Wide 24" Monitor 4420HB2 Wireless Kbd & Opt Wheel Mouse (via USB) 73P4067 Kensington Cable Lock from Lenovo 73P2582 ADD2 DVI-I PCIe Connection Adapter 73P2516 ADD2 DVI-D Monitor Connection (HDCP) 43R1985 ATI™ Radeon™ HD 2400 Pro 128MB 43R1961 ATI Radeon HD 2400 XT 256MB 43R1962 Acc Guide in pdf lenovo.com/accessoriesguide Other accessories at lenovo.com/accessories		
<ul style="list-style-type: none"> • Microsoft® Windows® Vista Business Edition (32-bit) Preloaded applications⁵ (only some listed) <ul style="list-style-type: none"> • <i>Some:</i> Education software <ul style="list-style-type: none"> - VitalSource Library College Edition - Adobe® Instructor Resource Center - Adobe Digital School Collection <ul style="list-style-type: none"> - Photoshop Elements 6 (and CD) - Premier Elements 4 (and DVD) - Acrobat 8 Professional (and CD) - Contribute 4 (and CD) • Rescue and Recovery™ • Client Security Solution™ • ThinkVantage Productivity Center • ThinkVantage System Update • Norton Internet Security™ • Diskeeper® Home • Microsoft Office 2007 Trial (60-day) • Sonic RecordNow and Drive Letter Access (combo, DVD±RW) • Corel® WinDVD® (combo, DVD±RW) 			

See footnotes for important warranty information

Ⓜ US model announced August 19, 2008; previous models on March 18 or March 25, 2008

ⓧ US model withdrawn effective September 2008

© Lenovo (MONA1-8) August 2008

Name	Type-model	Slot x bay	Processor	GHz	L2 cache	Core	Memory ⁸	SATA disk	SATA optical	Graphics	Vista preload	Vista logo	Global Educ	Avail date
M57e	9482-H1U	2x3	Core 2 Duo E7200	2.53	3MB	Dual	1GB	160GB ²	DVD±RW	GMA	Business32	Basic		Jul 08
M57e	9482-F9U	2x3	Core 2 Duo E7200	2.53	3MB	Dual	1GB	160GB	DVD±RW	GMA	Business32	Basic	Educ	Jul 08
M57e	9482-HCU	2x3	Core 2 Duo E7300	2.66	3MB	Dual	1GB	160GB	DVD±RW	GMA	Business32	Premium	Educ	Sep 08

• **These models have a 3-year limited warranty¹**

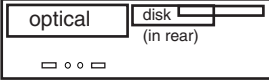
Positioning Processor	<i>Mainstream enterprise stability and manageability</i> Intel® Core™ 2 Duo Processor E7200 or E7300 with dual-core, Intel 64 Technology, Execute Disable Bit, EIST, and 1066MHz system bus with 3MB L2 cache		Small	
Implementation	Processor in FC-LGA8 package in LGA775 socket			
Memory	1GB std , 4GB max ⁸ , PC2-5300 667MHz DDR2 , non-parity, dual-channel capable, two 240-pin DIMM sockets; <i>Non-italics</i> : standard memory in one socket; one socket available		Bay ① 5.25", 1.6" high, access, std optical Bay ② 3.5", 1" high, no access, std disk Bay ③ 3.5", .5" high, access, open (reader/diskette)	
Graphics	Intel Graphics Media Accelerator 3100 (GMA 3100) , integrated graphics in G31, uses main memory (up to 256MB), one analog VGA DB-15 connector, supports dual independent display with optional ADD2 adapter		Slot 1: Low Profile, PCI Express x16 (35w max) Slot 2: Low Profile, 32-bit PCI 2.3	
SATA disk	160GB , SATA 3.0Gb/s 7200 rpm, vibration dampening mounts		Security <ul style="list-style-type: none"> • Security slot (in rear for attachment of optional Kensington® Microsaver® cable) - optional cable also locks the cover by deactivating the cover release buttons • Power-on password • Administrator password • Hard disk password • Boot sequence control • Boot without keyboard, mouse, diskette • Serial port I/O control • Parallel port I/O control • USB port disablement 	
SATA controller	Serial ATA, SATA 3.0Gb/s, integrated in ICH7			
SATA DVD±RW	Super Multi-Burner DL DVD±RW SATA 1.5Gb/s Drive (41N5620)			
SATA cables	Two SATA cables (each 1-drop to device), two SATA connectors			
eSATA port	None			
EIDE controller	Enhanced IDE, ATA-100, integrated in ICH7, one EIDE connector			
Diskette drive	None			
Media reader	None			
Chipset	Intel G31 Express Chipset ; I/O Controller Hub 7 (ICH7) for SATA 3.0Gb/s, ATA-100 EIDE, PCI Express® x1, PCI 2.3, USB, LPC bus / ITE Tech® IT8718 Super I/O for serial, parallel, keyboard, mouse functions			
Front ports	Two USB 2.0, microphone (stereo, 3.5mm), headphone (stereo, 3.5mm)			
Rear ports	Four USB 2.0, serial (9-pin), parallel (25-pin), keyboard (PS/2), mouse (PS/2), ethernet (RJ-45), monitor (VGA DB-15)			
Internal connector	Two USB 2.0 planar connectors (one used; one open for media reader)			
Rear audio ports	Line-in (stereo, 3.5mm), line-out (stereo, 3.5mm), microphone (stereo, 3.5mm)			
Audio	High Definition (HD) Audio, Realtek® ALC662 codec			
Speaker	One internal speaker for business audio			
Ethernet	Gigabit ethernet on planar, Marvell® 88E8056, PCIe x1, Wake on LAN®			
Intel AMT	None			
Modem	None			
Security chip	None			
Keyboard	Preferred Pro USB Keyboard (USB connector), 104-key, black, Lenovo logo			
Mouse	Optical Wheel Mouse (USB connector), 400 dpi, black, Lenovo logo			
Power supply	280 watts with variable speed fan, autosenesing			
Preloaded operating system²⁰	Accessories 1GB PC2-5300 CL5 NP DDR2 UDIMM 73P4984 2GB PC2-5300 CL5 NP DDR2 UDIMM 73P4985 1GB PC2-6400 NP DDR2 UDIMM 41U2977 2GB PC2-6400 NP DDR2 UDIMM 41U2978 250GB SATA 3.0Gb/s Disk (7200 rpm) 41N3015 500GB SATA 3.0Gb/s Disk (7200 rpm) 43R1990 USB Portable Diskette Drive 05K9276 USB 2.0 Lenovo Multimedia Headset 40Y8518 USB 2.0 Lenovo Webcam 40Y8519 USB 2.0 Essential Memory Key 32GB 45K1258 USB 2.0 Ultra Secure Memory Key 2GB 45J5916 USB 2.0 Ultra Secure Memory Key 4GB 45J5917 USB 2.0 Ultra Secure Memory Key 8GB 45J5918 USB 2.0 Portable 160GB Hard Disk 43R1784 USB 2.0 Portable Secure 320GB Hard Disk 43R2019 ThinkVision® L1700p 17" Monitor 9417HE2 ThinkVision L1940p Wide 19" Monitor 4424HB6 ThinkVision L2240p Wide 22" Monitor 4422HB6 ThinkVision L2440p Wide 24" Monitor 4420HB2 Wireless Kbd & Opt Wheel Mouse (via USB) 73P4067 Laser Tilt Wheel Mouse (USB, PS/2) 41U3074 Kensington Cable Lock from Lenovo 73P2582 ADD2 DVI-I PCIe Connection Adapter 73P2516 ADD2 DVI-D Monitor Connection (HDCP) 43R1985 ATI™ Radeon™ HD 2400 Pro 128MB 43R1961 ATI Radeon HD 2400 XT 256MB 43R1962 Acc Guide in pdf lenovo.com/accessoriesguide Other accessories at lenovo.com/accessories			
	Supports ThinkVantage® technologies			
	RoHS-compliant			
Preloaded applications⁵	Limited Warranty¹ ⇒ 3-year parts and labor ⇒ Customer Replaceable Unit (CRU) parts only (with limited onsite service for selected parts³, 8 am - 5 pm, Mon - Fri coverage excluding holidays, next business day response time) ⇒ Onsite service upgrade options (in eligible locations):⁷ <ul style="list-style-type: none"> • 3-year LOR 9x5, 4 hour response (ThinkPlus™ part number 41C9192) • 3-year LOR 24x7, 4 hour response (ThinkPlus part number 41C9193) • 4-year LOR 9x5, Next Business Day (ThinkPlus part number 41C9194) • 4-year LOR 9x5, 4 hour response (ThinkPlus part number 41C9195) • 4-year LOR 24x7, 4 hour response (ThinkPlus part number 41C9196) ⇒ ThinkPlus services at lenovo.com/thinkplus/warranty ⇒ Post warranty maintenance services available ⇒ 24 hour x 7 day¹⁴ toll-free support during the warranty period¹ via 800-426-7378			

See footnotes for important warranty information

¹⁸ US model announced August 19, 2008; previous models on June 24, 2008

Name	Type-model	Slot x bay	Processor	GHz	L2 cache	Cores	Memory ⁶	SATA disk	SATA optical	Graphics	Vista preload	Vista logo	Global Educ	Avail date
M57e	9482-H8U	2x3	Pentium E5200	2.50	2MB	2	1GB	160GB ²	DVD	GMA	Business32	Premium	None	Nov 08
M57e	9482-H9U	2x3	Pentium E5200	2.50	2MB	2	1GB	160GB	DVD±RW	GMA	Business32	Premium	None	Nov 08
M57e	9482-J1U	2x3	Pentium E5200	2.50	2MB	2	2GB	160GB	DVD±RW	GMA	Business32	Premium	None	Nov 08

• **These models have a 3-year limited warranty¹**

Positioning	<i>Mainstream enterprise stability and manageability</i>		Small	
Processor	Intel® Pentium® Dual-Core Processor E5200 with dual-core, 800MHz system bus, and 2MB L2 cache Processor in FC-LGA6 package in LGA775 socket			
Implementation	Processor in FC-LGA6 package in LGA775 socket		Bay ① 5.25", 1.6" high, access, std optical Bay ② 3.5", 1" high, no access, std disk Bay ③ 3.5", .5" high, access, open (reader/diskette)	
Memory	1GB or 2GB std, 4GB max⁸, PC2-5300 667MHz DDR2 , non-parity, dual-channel capable, two 240-pin DIMM sockets; <i>Non-italics:</i> standard memory in one socket; one socket available			
Graphics	Intel Graphics Media Accelerator 3100 (GMA 3100) , integrated graphics in G31, uses main memory (up to 256MB), one analog VGA DB-15 connector, supports dual independent display with optional ADD2 adapter		Slot 1: Low Profile, PCI Express x16 (35w max) Slot 2: Low Profile, 32-bit PCI 2.3 <ul style="list-style-type: none"> • Business black color; metal case • 12.5" W X 14.0" D X 3.9" H • 317mm W X 355mm D X 99mm H • 16.1 lb (7.3 kg) in maximum configuration • Bays 1, 2, 3 flip up (latched and pivoting) • Toolless cover flips up and tilts backward on rear hinges • Toolless disk, diskette drive, optical drive removal • Toolless adapter retention • Toolless systemboard retention • Steel chassis supports 100 lb (45kg) monitor on top • System floor stand for vertical orientation 	
SATA disk	160GB , SATA 3.0Gb/s 7200 rpm, vibration dampening mounts Serial ATA, SATA 3.0Gb/s, integrated in ICH7 <i>Some:</i> DVD-ROM DL SATA 1.5Gb/s 16-48X Max ⁴ Drive (41N5618) SATA DVD±RW <i>Some:</i> Super Multi-Burner DL DVD±RW SATA Drive (41N5620) SATA cables Two SATA cables (each 1-drop to device), two SATA connectors eSATA port None EIDE controller Enhanced IDE, ATA-100, integrated in ICH7, one EIDE connector Diskette drive None Media reader None			
Chipset	Intel G31 Express Chipset ; I/O Controller Hub 7 (ICH7) for SATA 3.0Gb/s, ATA-100 EIDE, PCI Express [®] x1, PCI 2.3, USB, LPC bus / ITE Tech [®] IT8718 Super I/O for serial, parallel, keyboard, mouse functions		Security <ul style="list-style-type: none"> • Security slot (in rear for attachment of optional Kensington[®] Microsaver[®] cable) - optional cable also locks the cover by deactivating the cover release buttons • Power-on password • Administrator password • Hard disk password • Boot sequence control • Boot without keyboard, mouse, diskette • Serial port I/O control • Parallel port I/O control • USB port disablement 	
Front ports	Two USB 2.0, microphone (stereo, 3.5mm), headphone (stereo, 3.5mm)			
Rear ports	Four USB 2.0, serial (9-pin), parallel (25-pin), keyboard (PS/2), mouse (PS/2), ethernet (RJ-45), monitor (VGA DB-15)			
Internal connector	Two USB 2.0 planar connectors (one used; one open for media reader)			
Rear audio ports	Line-in (stereo, 3.5mm), line-out (stereo, 3.5mm), microphone (stereo, 3.5mm)			
Audio	High Definition (HD) Audio, Realtek [®] ALC662 codec			
Speaker	One internal speaker for business audio			
Ethernet	Gigabit ethernet on planar, Marvell [®] 88E8056, PCIe x1, Wake on LAN [®]			
Intel AMT	None			
Modem	None			
Security chip	None			
Keyboard	Preferred Pro USB Keyboard (USB connector), 104-key, black, Lenovo logo			
Mouse	Optical Wheel Mouse (USB connector), 400 dpi, black, Lenovo logo			
Power supply	280 watts with variable speed fan, autosenesing			
Preloaded operating system²⁰	- Microsoft [®] Windows [®] Vista Business Edition (32-bit)		Supports ThinkVantage [®] technologies	
Preloaded applications⁵	<ul style="list-style-type: none"> • Rescue and Recovery[™] • Client Security Solution[™] • ThinkVantage Productivity Center • ThinkVantage System Update • System Migration Assistant • Norton Internet Security[™] (90 days of virus definitions) • Diskeeper[®] Home • PC-Doctor[™] (diagnostics) • Adobe[®] Reader • Windows Live[™] Toolbar • Windows Live Search • Picasa from Google • Microsoft Office 2007 Trial (60-day) • Sonic RecordNow and Drive Letter Access (DVD±RW) • Corel[®] WinDVD[®] (DVD, DVD±RW) 		RoHS-compliant	
Accessories	1GB PC2-5300 CL5 NP DDR2 UDIMM 73P4984 2GB PC2-5300 CL5 NP DDR2 UDIMM 73P4985 1GB PC2-6400 NP DDR2 UDIMM 41U2977 2GB PC2-6400 NP DDR2 UDIMM 41U2978 250GB SATA 3.0Gb/s Disk (7200 rpm) 41N3015 500GB SATA 3.0Gb/s Disk (7200 rpm) 43R1990 USB Portable Diskette Drive 05K9276 USB 2.0 Lenovo Multimedia Headset 40Y8518 USB 2.0 Lenovo Webcam 40Y8519 USB 2.0 Essential Memory Key 32GB 45K1258 USB 2.0 Security Memory Key 2GB 41U5119 USB 2.0 Security Memory Key 4GB 41U5120 USB 2.0 Ultra Secure Memory Key 2GB 45J5916 USB 2.0 Ultra Secure Memory Key 4GB 45J5917 USB 2.0 Ultra Secure Memory Key 8GB 45J5918 USB 2.0 Portable Secure 320GB Hard Disk 43R2019 ThinkVision [®] L1700p 17" Monitor 9417HE2 ThinkVision L1940p Wide 19" Monitor 4424HB6 ThinkVision L2240p Wide 22" Monitor 4422HB6 ThinkVision L2440p Wide 24" Monitor 4420HB2 Wireless Kbd & Opt Wheel Mouse (via USB) 73P4067 Laser Tilt Wheel Mouse (USB, PS/2) 41U3074 Kensington Cable Lock from Lenovo 73P2582 ADD2 DVI-I PCIe Connection Adapter 73P2516 ADD2 DVI-D Monitor Connection (HDCP) 43R1985 ATI [™] Radeon [™] HD 2400 Pro 128MB 43R1961 ATI Radeon HD 2400 XT 256MB 43R1962 Acc Guide in pdf lenovo.com/accessoriesguide Other accessories at lenovo.com/accessories		Limited Warranty¹ <ul style="list-style-type: none"> ⇒ 3-year parts and labor ⇒ Customer Replaceable Unit (CRU) parts only (with limited onsite service for selected parts³, 8 am - 5 pm, Mon - Fri coverage excluding holidays, next business day response time) ⇒ Onsite service upgrade options (in eligible locations):⁷ <ul style="list-style-type: none"> • 3-year LOR 9x5, 4 hour response (ThinkPlus[™] part number 41C9192) • 3-year LOR 24x7, 4 hour response (ThinkPlus part number 41C9193) • 4-year LOR 9x5, Next Business Day (ThinkPlus part number 41C9194) • 4-year LOR 9x5, 4 hour response (ThinkPlus part number 41C9195) • 4-year LOR 24x7, 4 hour response (ThinkPlus part number 41C9196) ⇒ ThinkPlus services at lenovo.com/thinkplus/warranty ⇒ Post warranty maintenance services available ⇒ 24 hour x 7 day¹⁴ toll-free support during the warranty period¹ via 800-426-7378 	

See footnotes for important warranty information
 US models announced October 21, 2008

Name	Type-model	Slot x bay	Processor	GHz	L2 cache	Core Memory ^a	SATA disk	SATA optical	Graphics	ENERGY STAR 4.0	Floor stand	Vista preload	Vista logo	Global Educ	Avail date
M57e	9487-ADU	2x3	Core 2 Duo E4600	2.40	2MB	Dual 1GB	160GB ²	Combo	GMA	ES40	Stand	Bus32	Basic	Gbl	Mar 08
M57e	9487-AFU	2x3	Core 2 Duo E4600	2.40	2MB	Dual 1GB	160GB	Combo	GMA+ADD2	ES40		Bus32	Basic	Gbl	Mar 08
M57e	9487-AEU	2x3	Core 2 Duo E8200	2.66	6MB	Dual 1GB	160GB	Combo	GMA	ES40	Stand	Bus32	Basic	Gbl	Mar 08
M57e	9487-AGU	2x3	Core 2 Duo E8400	3.00	6MB	Dual 2GB	250GB	DVD±RW	GMA+ADD2	ES40		Bus32	Prem	Gbl	Mar 08

• **These models have a 3-year limited warranty¹**

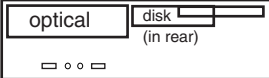
Positioning Processor	<i>Mainstream enterprise stability and manageability</i> Intel® Core™ 2 Duo Processor E4600 with dual-core , Intel 64 Technology, Execute Disable Bit, EIST, 800MHz system bus, and 2MB shared L2 cache or Intel Core 2 Duo Processor E8200 or E8400 with dual-core , Intel 64 Technology, Virtualization Technology, Execute Disable Bit, EIST, TXT, and 1333MHz system bus with 6MB shared L2 cache Processor in FC-LGA6 or FC-LGA8 package in LGA775 socket		Small 
Implementation	Bay ① 5.25", 1.6" high, access, std optical Bay ② 3.5", 1" high, no access, std disk Bay ③ 3.5", .5" high, access, open (reader/diskette)		
Memory	1GB or 2GB std , 4GB max ⁸ , PC2-5300 667MHz DDR2 , non-parity, dual-channel capable, two 240-pin DIMM sockets; <i>Italics:</i> standard memory in both sockets; no sockets avail; <i>Non-italics:</i> standard memory in one socket; one socket available		Slot 1: Low Profile, PCI Express x16 (35w max) [*] Slot 2: Low Profile, 32-bit PCI 2.3 [*] used in some models
Graphics	<i>All:</i> Intel Graphics Media Accelerator 3100 (GMA 3100) , integrated graphics in G31, uses main memory (up to 256MB), one analog VGA DB-15 connector <i>Some:</i> ADD2 DVI-I PCIe Connection Adapter , PCI Express [®] adapter in PCIe x16 slot, provides DVI-I connector to support second monitor, no DVI-to-VGA dongle		<ul style="list-style-type: none"> • Business black color; metal case • 12.5" W X 14.0" D X 3.9" H • 317mm W X 355mm D X 99mm H • 16.1 lb (7.3 kg) in maximum configuration • Bays 1, 2, 3 flip up (latched and pivoting) • Toolless cover flips up and tilts backward on rear hinges • Toolless disk, diskette drive, optical drive removal • Toolless adapter retention • Toolless systemboard retention • Steel chassis supports 100 lb (45kg) monitor on top • <i>Some:</i> system floor stand for vertical orientation
SATA disk	160GB or 250GB , SATA 3.0Gb/s 7200 rpm, vibration dampening		<p align="center">Security</p> <ul style="list-style-type: none"> • Security slot (in rear for attachment of optional Kensington® Microsaver® cable) - optional cable also locks the cover by deactivating the cover release buttons • Power-on password • Administrator password • Hard disk password • Boot sequence control • Boot without keyboard, mouse, diskette • Serial port I/O control • Parallel port I/O control • USB port disablement <p align="center">Supports ThinkVantage® technologies</p> <p align="center">EPEAT™ Gold rating ENERGY STAR 4.0-compliant RoHS-compliant</p> <p align="center">Limited Warranty¹</p> <ul style="list-style-type: none"> ↪ 3-year parts and labor ↪ Customer Replaceable Unit (CRU) parts only (with limited onsite service for selected parts³, 8 am - 5 pm, Mon - Fri coverage excluding holidays, next business day response time) ↪ Onsite service upgrade options (in eligible locations):⁷ <ul style="list-style-type: none"> • 3-year LOR 9x5, 4 hour response (ThinkPlus™ part number 41C9192) • 3-year LOR 24x7, 4 hour response (ThinkPlus part number 41C9193) • 4-year LOR 9x5, Next Business Day (ThinkPlus part number 41C9194) • 4-year LOR 9x5, 4 hour response (ThinkPlus part number 41C9195) • 4-year LOR 24x7, 4 hour response (ThinkPlus part number 41C9196) ↪ ThinkPlus services at lenovo.com/thinkplus/warranty ↪ Post warranty maintenance services available ↪ 24 hour x 7 day¹⁴ toll-free support during the warranty period¹ via 800-426-7378
SATA controller	Serial ATA, SATA 3.0Gb/s, integrated in ICH7		
SATA Combo	<i>Some:</i> CD-RW/DVD-ROM Combo SATA 1.5Gb/s Drive		
SATA DVD±RW	<i>Some:</i> Super Multi-Burner DL DVD±RW SATA Drive (41N5620)		
SATA cables	Two SATA cables (each 1-drop to device), two SATA connectors on planar		
eSATA port	None		
EIDE controller	Enhanced IDE, ATA-100, integrated in ICH7, one EIDE connector on planar		
Diskette drive	None		
Media reader	None		
Chipset	Intel G31 Express Chipset ; I/O Controller Hub 7 (ICH7) for SATA 3.0Gb/s, ATA-100 EIDE, PCI Express x1, PCI 2.3, USB, LPC bus / ITE Tech® IT8718 Super I/O for serial, parallel, keyboard, mouse functions		
Front ports	Two USB 2.0, microphone (stereo, 3.5mm), headphone (stereo, 3.5mm)		
Rear ports	Four USB 2.0, serial (9-pin), parallel (25-pin), keyboard (PS/2), mouse (PS/2), ethernet (RJ-45), monitor (VGA DB-15, DVI-I in some models)		
Internal connector	Two USB 2.0 planar connectors (one used; one open for media reader)		
Rear audio ports	Line-in (stereo, 3.5mm), line-out (stereo, 3.5mm), microphone (stereo, 3.5mm)		
Audio	High Definition (HD) Audio, Realtek® ALC662 codec		
Speaker	One internal speaker for business audio		
Ethernet	Gigabit ethernet on planar, Marvel® 88E8056, PCIe x1, Wake on LAN®		
Intel AMT	None		
Modem	None		
Security chip	None		
Keyboard	Preferred Pro USB Keyboard (USB connector), 104-key, black, Lenovo logo		
Mouse	Optical Wheel Mouse (USB connector), 400 dpi, black, Lenovo logo		
Power supply	280 watts with variable speed fan, autosensing, 80% PSU		
Preloaded operating system²⁰	Accessories		
- Microsoft® Windows® Vista® Business Edition (32-bit)	1GB PC2-5300 CL5 NP DDR2 UDIMM	73P4984	
	2GB PC2-5300 CL5 NP DDR2 UDIMM	73P4985	
	1GB PC2-6400 NP DDR2 UDIMM	41U2977	
	2GB PC2-6400 NP DDR2 UDIMM	41U2978	
	250GB SATA 3.0Gb/s Disk (7200 rpm)	41N3015	
	500GB SATA 3.0Gb/s Disk (7200 rpm)	43R1990	
	USB 2.0 Lenovo Multimedia Headset	40Y8518	
	USB 2.0 Lenovo Webcam	40Y8519	
	USB 2.0 Essential Memory Key 32GB	45K1258	
	USB 2.0 Ultra Secure Memory Key 2GB	45J5916	
	USB 2.0 Ultra Secure Memory Key 4GB	45J5917	
	USB 2.0 Ultra Secure Memory Key 8GB	45J5918	
	USB 2.0 Portable Secure 320GB Hard Disk	43R2019	
	ThinkVision® L1940p Wide 19" Monitor	4424HB6	
	ThinkVision L2240p Wide 22" Monitor	4422HB6	
	ThinkVision L2440p Wide 24" Monitor	4420HB2	
	Wireless Kbd & Opt Wheel Mouse (via USB)	73P4067	
	Kensington Cable Lock from Lenovo	73P2582	
	ADD2 DVI-I PCIe Connection Adapter	73P2516	
	ADD2 DVI-D Monitor Connection (HDCP)	43R1985	
	ATI™ Radeon™ HD 2400 Pro 128MB	43R1961	
	ATI Radeon HD 2400 XT 256MB	43R1962	
	Acc Guide in pdf lenovo.com/accessoriesguide		
	Other accessories at lenovo.com/accessories		

See footnotes for important warranty information
US models announced March 18, 2008

Name	Type-model	Slot x bay	Processor	GHz	L2 cache	Core	Memory ⁸	SATA disk	SATA optical	Graphics	ENERGY STAR 4.0	Preload	Vista logo	Global Educ	Avail date	
ES	M57e	9487-B3U	2x3	Pentium E2180	2.00	1MB	Dual	1GB	160GB ²	DVD±RW	GMA	ES40	XP Pro	None	Sep 08	
ES	M57e	9487-B4U	2x3	Pentium E2200	2.20	1MB	Dual	2GB	160GB	DVD±RW	GMA	ES40	XP Pro	None	Sep 08	
ES	M57e	9487-B5U	2x3	Core 2 Duo E7200	2.53	3MB	Dual	1GB	160GB	DVD±RW	GMA	ES40	XP Pro	None	Sep 08	
ES	M57e	9487-B6U	2x3	Core 2 Duo E7200	2.53	3MB	Dual	2GB	160GB	DVD	GMA	ES40	XP Pro	None	Sep 08	
ES	M57e	9487-B1U	2x3	Core 2 Duo E7200	2.53	3MB	Dual	1GB	160GB	DVD±RW	GMA	ES40	Bus32	Basic	None	Jul 08
ES	M57e	9487-B7U	2x3	Core 2 Duo E7300	2.66	3MB	Dual	1GB	160GB	DVD±RW	GMA	ES40	Bus32	Prem	None	Sep 08

• These models have a 3-year limited warranty¹

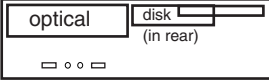
Positioning Processor	Mainstream enterprise stability and manageability Intel® Pentium® Dual-Core Processor E2180 or E2200 with dual-core , Intel 64 Technology, Execute Disable Bit, EIST, 800MHz system bus, and 1MB L2 cache or Intel Core™ 2 Duo Processor E7200 or E7300 with dual-core , Intel 64 Technology, Execute Disable Bit, EIST, and 1066MHz system bus with 3MB L2 cache	Small 
Implementation	Processor in FC-LGA6 or FC-LGA8 package in LGA775 socket	
Memory	1GB or 2GB std , 4GB max ⁸ , PC2-5300 667MHz DDR2 , non-parity, dual-channel capable, two 240-pin DIMM sockets; <i>Non-italics:</i> standard memory in one socket; one socket available	Bay ① 5.25", 1.6" high, access, std optical Bay ② 3.5", 1" high, no access, std disk Bay ③ 3.5", .5" high, access, open (reader/diskette) Slot 1: Low Profile, PCI Express x16 (35w max) Slot 2: Low Profile, 32-bit PCI 2.3
Graphics	Intel Graphics Media Accelerator 3100 (GMA 3100) , integrated graphics in G31, uses main memory (up to 256MB), one analog VGA DB-15 connector, supports dual independent display with optional ADD2 adapter	<ul style="list-style-type: none"> • Business black color; metal case • 12.5" W X 14.0" D X 3.9" H • 317mm W X 355mm D X 99mm H • 16.1 lb (7.3 kg) in maximum configuration • Bays 1, 2, 3 flip up (latched and pivoting) • Toolless cover flips up and tilts backward on rear hinges • Toolless disk, diskette drive, optical drive removal • Toolless adapter retention • Toolless systemboard retention • Steel chassis supports 100 lb (45kg) monitor on top • System floor stand for vertical orientation
SATA disk	160GB , SATA 3.0Gb/s 7200 rpm, vibration dampening mounts	Security <ul style="list-style-type: none"> • Security slot (in rear for attachment of optional Kensington® Microsaver® cable) - optional cable also locks the cover by deactivating the cover release buttons • Power-on password • Administrator password • Hard disk password • Boot sequence control • Boot without keyboard, mouse, diskette • Serial port I/O control • Parallel port I/O control • USB port disablement Supports ThinkVantage® technologies
SATA controller	Serial ATA, SATA 3.0Gb/s, integrated in ICH7	
SATA DVD	<i>Some:</i> DVD-ROM DL SATA 1.5Gb/s 16-48X Max ⁴ Drive (41N5618)	
SATA DVD±RW	<i>Some:</i> Super Multi-Burner DL DVD±RW SATA Drive (41N5620)	
SATA cables	Two SATA cables (each 1-drop to device), two SATA connectors	
eSATA port	None	
EIDE controller	Enhanced IDE, ATA-100, integrated in ICH7, one EIDE connector on planar	
Diskette drive	None	
Media reader	None	
Chipset	Intel G31 Express Chipset ; I/O Controller Hub 7 (ICH7) for SATA 3.0Gb/s, ATA-100 EIDE, PCI Express® x1, PCI 2.3, USB, LPC bus / ITE Tech® IT8718 Super I/O for serial, parallel, keyboard, mouse functions	
Front ports	Two USB 2.0, microphone (stereo, 3.5mm), headphone (stereo, 3.5mm)	
Rear ports	Four USB 2.0, serial (9-pin), parallel (25-pin), keyboard (PS/2), mouse (PS/2), ethernet (RJ-45), monitor (VGA DB-15)	
Internal connector	Two USB 2.0 planar connectors (one used; one open for media reader)	
Rear audio ports	Line-in (stereo, 3.5mm), line-out (stereo, 3.5mm), microphone (stereo, 3.5mm)	
Audio	High Definition (HD) Audio, Realtek® ALC662 codec	
Speaker	One internal speaker for business audio	
Ethernet	Gigabit ethernet on planar, Marvell® 88E8056, PCIe x1, Wake on LAN®	
Intel AMT	None	
Modem	None	
Security chip	None	
Keyboard	Preferred Pro USB Keyboard (USB connector), 104-key, black, Lenovo logo	
Mouse	Optical Wheel Mouse (USB connector), 400 dpi, black, Lenovo logo	
Power supply	280 watts with variable speed fan, autosensing, 80% PSU	
Preloaded operating system²⁰	Accessories	Limited Warranty¹ <ul style="list-style-type: none"> ↔ 3-year parts and labor ↔ Customer Replaceable Unit (CRU) parts only (with limited onsite service for selected parts³, 8 am - 5 pm, Mon - Fri coverage excluding holidays, next business day response time) ↔ Onsite service upgrade options (in eligible locations):⁷ <ul style="list-style-type: none"> • 3-year LOR 9x5, 4 hour response (ThinkPlus™ part number 41C9192) • 3-year LOR 24x7, 4 hour response (ThinkPlus part number 41C9193) • 4-year LOR 9x5, Next Business Day (ThinkPlus part number 41C9194) • 4-year LOR 9x5, 4 hour response (ThinkPlus part number 41C9195) • 4-year LOR 24x7, 4 hour response (ThinkPlus part number 41C9196) ↔ ThinkPlus services at lenovo.com/thinkplus/warranty ↔ Post warranty maintenance services available ↔ 24 hour x 7 day¹⁴ toll-free support during the warranty period¹ via 800-426-7378
- <i>Some:</i> Microsoft® Windows® XP Professional with Vista® COA	1GB PC2-5300 CL5 NP DDR2 UDIMM 73P4984	
- <i>Some:</i> Microsoft Windows Vista Business Edition (32-bit)	2GB PC2-5300 CL5 NP DDR2 UDIMM 73P4985	
Preloaded applications⁵ (all OSes)	1GB PC2-6400 NP DDR2 UDIMM 41U2977	
• Rescue and Recovery™	2GB PC2-6400 NP DDR2 UDIMM 41U2978	
• Client Security Solution™	250GB SATA 3.0Gb/s Disk (7200 rpm) 41N3015	
• ThinkVantage Productivity Center	500GB SATA 3.0Gb/s Disk (7200 rpm) 43R1990	
• ThinkVantage System Update	USB Portable Diskette Drive 05K9276	
• System Migration Assistant	USB 2.0 Lenovo Multimedia Headset 40Y8518	
• Norton Internet Security™ (90 days of virus definitions)	USB 2.0 Lenovo Webcam 40Y8519	
• Diskeeper® Home	USB 2.0 Essential Memory Key 32GB 45K1258	
• PC-Doctor™ (diagnostics)	USB 2.0 Ultra Secure Memory Key 4GB 45J5917	
• Adobe® Reader	USB 2.0 Ultra Secure Memory Key 8GB 45J5918	
• Windows Live™ Toolbar	USB 2.0 Portable Secure 320GB Hard Disk 43R2019	
• Windows Live Search	ThinkVision® L1940p Wide 19" Monitor 4424HB6	
• Picasa from Google	ThinkVision L2240p Wide 22" Monitor 4422HB6	
• Microsoft Office 2007 Trial (60-day)	ThinkVision L2440p Wide 24" Monitor 4420HB2	
• Multimedia Center for Think Offerings (DVD, DVD±RW) (XP)	Wireless Kbd & Opt Wheel Mouse (via USB) 73P4067	
• Sonic RecordNow and Drive Letter Access (DVD±RW)	Laser Tilt Wheel Mouse (USB, PS/2) 41U3074	
• Corel® WinDVD® (DVD, DVD±RW)	Kensington Cable Lock from Lenovo 73P2582	
• Corel WinDVD Creator (DVD±RW) (XP)	ADD2 DVI-I PCIe Connection Adapter 73P2516	
	ADD2 DVI-D Monitor Connection (HDCP) 43R1985	
	ATI™ Radeon™ HD 2400 Pro 128MB 43R1961	
	ATI Radeon HD 2400 XT 256MB 43R1962	
	Acc Guide in pdf lenovo.com/accessoriesguide	
	Other accessories at lenovo.com/accessories	

See footnotes for important warranty information

ES US models announced August 19, 2008; previous model on June 24, 2008

ThinkCentre® M57e Small (6178) - ENERGY STAR® 4.0 (GMP)

Personal Systems Reference (PSREF)

Name	Type-model	Slot x bay	Processor	GHz	L2 cache	Core	Memory ^a	SATA disk	SATA optical	Graphics	ENERGY STAR 4.0	Vista preload	Limited warranty ¹	Global (G) GMP (P)	Avail date
M57e	6178-B1U	2x3	Core 2 Duo E8400	3.00	6MB	Dual	1GB	160GB ²	DVD±RW	GMA	ES40	Business32	3-yr	G P	Jul 08

- This model is part of the Global Models Plus (GMP) program with limited onsite service³ 3-year limited warranty

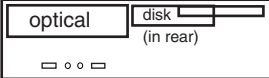
Positioning Processor	Mainstream enterprise stability and manageability Intel® Core™ 2 Duo Processor E8400 with dual-core, Intel 64 Technology, Virtualization Technology, Execute Disable Bit, EIST, TXT, and 1333MHz system bus with 6MB L2 cache										Small							
Implementation	Processor in FC-LGA8 package in LGA775 socket										Bay ① 5.25", 1.6" high, access, std optical Bay ② 3.5", 1" high, no access, std disk Bay ③ 3.5", .5" high, access, open (reader/diskette)							
Memory	1GB std , 4GB max ⁸ , PC2-5300 667MHz DDR2 , non-parity, dual-channel capable, two 240-pin DIMM sockets; <i>Non-italics</i> : standard memory in one socket; one socket available										Slot 1: Low Profile, PCI Express x16 (35w max) Slot 2: Low Profile, 32-bit PCI 2.3							
Graphics	Intel Graphics Media Accelerator 3100 (GMA 3100) , integrated graphics in G31, uses main memory (up to 256MB), one analog VGA DB-15 connector, supports dual independent display with optional ADD2 adapter										<ul style="list-style-type: none"> • Business black color; metal case • 12.5" W X 14.0" D X 3.9" H • 317mm W X 355mm D X 99mm H • 16.1 lb (7.3 kg) in maximum configuration • Bays 1, 2, 3 flip up (latched and pivoting) • Toolless cover flips up and tilts backward on rear hinges • Toolless disk, diskette drive, optical drive removal • Toolless adapter retention • Toolless systemboard retention • Steel chassis supports 100 lb (45kg) monitor on top • System floor stand for vertical orientation 							
SATA disk	160GB , SATA 3.0Gb/s 7200 rpm, vibration dampening mounts										Security <ul style="list-style-type: none"> • Security slot (in rear for attachment of optional Kensington® Microsaver® cable) - optional cable also locks the cover by deactivating the cover release buttons • Power-on password • Administrator password • Hard disk password • Boot sequence control • Boot without keyboard, mouse, diskette • Serial port I/O control • Parallel port I/O control • USB port disablement 							
SATA controller	Serial ATA, SATA 3.0Gb/s, integrated in ICH7																	
SATA DVD±RW	Super Multi-Burner DL DVD±RW SATA 1.5Gb/s Drive (41N5620)																	
SATA cables	Two SATA cables (each 1-drop to device), two SATA connectors																	
eSATA port	None																	
EIDE controller	Enhanced IDE, ATA-100, integrated in ICH7, one EIDE connector																	
Diskette drive	None																	
Media reader	None																	
Chipset	Intel G31 Express Chipset ; I/O Controller Hub 7 (ICH7) for SATA 3.0Gb/s, ATA-100 EIDE, PCI Express® x1, PCI 2.3, USB, LPC bus / ITE Tech® IT8718 Super I/O for serial, parallel, keyboard, mouse functions										Supports ThinkVantage® technologies EPEAT™ Gold rating ENERGY STAR 4.0-compliant RoHS-compliant Limited Warranty¹ <ul style="list-style-type: none"> ↔ 3-year parts and labor ↔ International Warranty Service⁹ ↔ Customer Replaceable Unit (CRU) parts only (with limited onsite service for selected parts³, 8 am - 5 pm, Mon - Fri coverage excluding holidays, next business day response time) ↔ Onsite service upgrade options (in eligible locations):⁷ <ul style="list-style-type: none"> • 4-year LOR 9x5, Next Business Day (ThinkPlus part number 41C9194) • 4-year LOR 9x5, 4 hour response (ThinkPlus part number 41C9195) • 4-year LOR 24x7, 4 hour response (ThinkPlus part number 41C9196) ↔ ThinkPlus services at lenovo.com/thinkplus/warranty ↔ Post warranty maintenance services available ↔ 24 hour x 7 day¹⁴ toll-free support during the warranty period¹ via 800-426-7378 							
Front ports	Two USB 2.0, microphone (stereo, 3.5mm), headphone (stereo, 3.5mm)																	
Rear ports	Four USB 2.0, serial (9-pin), parallel (25-pin), keyboard (PS/2), mouse (PS/2), ethernet (RJ-45), monitor (VGA DB-15)																	
Internal connector	Two USB 2.0 planar connectors (one used; one open for media reader)																	
Rear audio ports	Line-in (stereo, 3.5mm), line-out (stereo, 3.5mm), microphone (stereo, 3.5mm)																	
Audio	High Definition (HD) Audio, Realtek® ALC662 codec																	
Speaker	One internal speaker for business audio																	
Ethernet	Gigabit ethernet on planar, Marvel® 88E8056, PCIe x1, Wake on LAN®																	
Intel AMT	None																	
Modem	None																	
Security chip	None																	
Keyboard	Preferred Pro USB Keyboard (USB connector), 104-key, black, Lenovo logo																	
Mouse	Optical Wheel Mouse (USB connector), 400 dpi, black, Lenovo logo																	
Power supply	280 watts with variable speed fan, autosenesing, 80% PSU																	
Preloaded operating system²⁰	- Microsoft® Windows® Vista® Business Edition (32-bit) ↕ Vista Basic logo										Accessories							
Preloaded applications⁵	<ul style="list-style-type: none"> • Rescue and Recovery™ • Client Security Solution™ • ThinkVantage Productivity Center • ThinkVantage System Update • System Migration Assistant • Norton Internet Security™ (90 days of virus definitions) • Diskeeper® Home • PC-Doctor™ (diagnostics) • Adobe® Reader • Windows Live™ Toolbar • Windows Live Search • Picasa from Google • Microsoft Office 2007 Trial (60-day) • Sonic RecordNow and Drive Letter Access (DVD±RW) • Corel® WinDVD® (DVD±RW) 																	
	1GB PC2-5300 CL5 NP DDR2 UDIMM														73P4984			
	2GB PC2-5300 CL5 NP DDR2 UDIMM														73P4985			
	1GB PC2-6400 NP DDR2 UDIMM														41U2977			
	2GB PC2-6400 NP DDR2 UDIMM														41U2978			
	250GB SATA 3.0Gb/s Disk (7200 rpm)														41N3015			
	500GB SATA 3.0Gb/s Disk (7200 rpm)														43R1990			
	USB Portable Diskette Drive														05K9276			
	USB 2.0 Lenovo Multimedia Headset														40Y8518			
	USB 2.0 Lenovo Webcam										40Y8519							
	USB 2.0 Essential Memory Key 32GB										45K1258							
	USB 2.0 Security Memory Key 2GB										41U5119							
	USB 2.0 Security Memory Key 4GB										41U5120							
	USB 2.0 Ultra Secure Memory Key 2GB										45J5916							
	USB 2.0 Ultra Secure Memory Key 4GB										45J5917							
	USB 2.0 Ultra Secure Memory Key 8GB										45J5918							
	USB 2.0 Portable 160GB Hard Disk										43R1784							
	USB 2.0 Portable Secure 320GB Hard Disk										43R2019							
	ThinkVision® L1700p 17" Monitor										9417HE2							
	ThinkVision L1940p Wide 19" Monitor										4424HB6							
	ThinkVision L2240p Wide 22" Monitor										4422HB6							
	ThinkVision L2440p Wide 24" Monitor										4420HB2							
	Wireless Kbd & Opt Wheel Mouse (via USB)										73P4067							
	Laser Tilt Wheel Mouse (USB, PS/2)										41U3074							
	Kensington Cable Lock from Lenovo										73P2582							
	ADD2 DVI-I PCIe Connection Adapter										73P2516							
	ADD2 DVI-D Monitor Connection (HDCP)										43R1985							
	ATI™ Radeon™ HD 2400 Pro 128MB										43R1961							
	ATI Radeon HD 2400 XT 256MB										43R1962							
	Acc Guide in pdf lenovo.com/accessoriesguide																	
	Other accessories at lenovo.com/accessories																	

See footnotes for important warranty information
US model announced June 24, 2008

Name	Type-model	Slot x bay	Processor	GHz	L2 cache	Core	Memory ^a	SATA disk	SATA optical	Graphics	Vista preload	Vista logo	Limited warranty ¹	Global (G) GMP (P)	Avail date
M57e	7066-AAU	2x3	Pentium E2200	2.20	1MB	Dual	1GB	160GB ²	Combo	GMA	Business32	Basic	3-yr	G P	Apr 08

• This model is part of the Global Models Plus (GMP) program with limited onsite service³ 3-year limited warranty

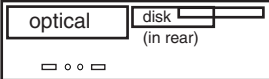
Positioning Processor	<i>Mainstream enterprise stability and manageability</i> Intel® Pentium® Dual-Core Processor E2200 with dual-core, Intel 64 Technology, Execute Disable Bit, EIST, and 800MHz system bus with 1MB shared L2 cache Processor in FC-LGA6 package in LGA775 socket		Small	
Implementation	Processor in FC-LGA6 package in LGA775 socket			
Memory	1GB std, 4GB max⁸, PC2-5300 667MHz DDR2 , non-parity, dual-channel capable, two 240-pin DIMM sockets; <i>Non-italics:</i> standard memory in one socket; one socket available		Bay ① 5.25", 1.6" high, access, std optical Bay ② 3.5", 1" high, no access, std disk Bay ③ 3.5", .5" high, access, open (reader/diskette)	
Graphics	Intel Graphics Media Accelerator 3100 (GMA 3100) , integrated graphics in G31, uses main memory (up to 256MB), one analog VGA DB-15 connector, supports dual independent display with optional ADD2 adapter		Slot 1: Low Profile, PCI Express x16 (35w max) Slot 2: Low Profile, 32-bit PCI 2.3	
SATA disk	160GB , SATA 3.0Gb/s 7200 rpm, vibration dampening mounts		<ul style="list-style-type: none"> • Business black color; metal case • 12.5" W X 14.0" D X 3.9" H • 317mm W X 355mm D X 99mm H • 16.1 lb (7.3 kg) in maximum configuration • Bays 1, 2, 3 flip up (latched and pivoting) • Toolless cover flips up and tilts backward on rear hinges • Toolless disk, diskette drive, optical drive removal • Toolless adapter retention • Toolless systemboard retention • Steel chassis supports 100 lb (45kg) monitor on top • System floor stand for vertical orientation 	
SATA controller	Serial ATA, SATA 3.0Gb/s, integrated in ICH7			
SATA Combo	CD-RW/DVD-ROM Combo SATA 1.5Gb/s Drive			
SATA cables	Two SATA cables (each 1-drop to device), two SATA connectors			
eSATA port	None			
EIDE controller	Enhanced IDE, ATA-100, integrated in ICH7, one EIDE connector			
Diskette drive	None			
Media reader	None			
Chipset	Intel G31 Express Chipset ; I/O Controller Hub 7 (ICH7) for SATA 3.0Gb/s, ATA-100 EIDE, PCI Express [®] x1, PCI 2.3, USB, LPC bus / ITE Tech [®] IT8718 Super I/O for serial, parallel, keyboard, mouse functions			
Front ports	Two USB 2.0, microphone (stereo, 3.5mm), headphone (stereo, 3.5mm)			
Rear ports	Four USB 2.0, serial (9-pin), parallel (25-pin), keyboard (PS/2), mouse (PS/2), ethernet (RJ-45), monitor (VGA DB-15)			
Internal connector	Two USB 2.0 planar connectors (one used; one open for media reader)			
Rear audio ports	Line-in (stereo, 3.5mm), line-out (stereo, 3.5mm), microphone (stereo, 3.5mm)			
Audio	High Definition (HD) Audio, Realtek [®] ALC662 codec			
Speaker	One internal speaker for business audio			
Ethernet	Gigabit ethernet on planar, Marvell [®] 88E8056, PCIe x1, Wake on LAN [®]			
Intel AMT	None			
Modem	None			
Security chip	None			
Keyboard	Preferred Pro USB Keyboard (USB connector), 104-key, black, Lenovo logo			
Mouse	Optical Wheel Mouse (USB connector), 400 dpi, black, Lenovo logo			
Power supply	280 watts with variable speed fan, autosensing			
Preloaded operating system²⁰	Accessories			
- Microsoft® Windows® Vista® Business Edition (32-bit)	1GB PC2-5300 CL5 NP DDR2 UDIMM	73P4984		
	2GB PC2-5300 CL5 NP DDR2 UDIMM	73P4985		
	1GB PC2-6400 NP DDR2 UDIMM	41U2977		
	2GB PC2-6400 NP DDR2 UDIMM	41U2978		
	250GB SATA 3.0Gb/s Disk (7200 rpm)	41N3015		
	500GB SATA 3.0Gb/s Disk (7200 rpm)	43R1990		
	USB 2.0 Lenovo Multimedia Headset	40Y8518		
	USB 2.0 Lenovo Webcam	40Y8519		
	USB 2.0 Essential Memory Key 32GB	45K1258		
	USB 2.0 Ultra Secure Memory Key 2GB	45J5916		
	USB 2.0 Ultra Secure Memory Key 4GB	45J5917		
	USB 2.0 Ultra Secure Memory Key 8GB	45J5918		
	USB 2.0 Portable 160GB Hard Disk	43R1784		
	USB 2.0 Portable Secure 320GB Hard Disk	43R2019		
	Super Multi-Burner DL DVD±RW SATA Drive	41N5620		
	ThinkVision® L1700p 17" Monitor	9417HE2		
	ThinkVision L1940p Wide 19" Monitor	4424HB6		
	ThinkVision L2240p Wide 22" Monitor	4422HB6		
	ThinkVision L2440p Wide 24" Monitor	4420HB2		
	Wireless Kbd & Opt Wheel Mouse (via USB)	73P4067		
	Laser Tilt Wheel Mouse (USB, PS/2)	41U3074		
	Kensington Cable Lock from Lenovo	73P2582		
	ADD2 DVI-I PCIe Connection Adapter	73P2516		
	ADD2 DVI-D Monitor Connection (HDCP)	43R1985		
	ATI™ Radeon™ HD 2400 Pro 128MB	43R1961		
	ATI Radeon HD 2400 XT 256MB	43R1962		
	Acc Guide in pdf lenovo.com/accessoriesguide			
	Other accessories at lenovo.com/accessories			
	Supports ThinkVantage [®] technologies			
	RoHS-compliant			
	Limited Warranty¹			
	<ul style="list-style-type: none"> ↪ 3-year parts and labor ↪ International Warranty Service⁹ ↪ Customer Replaceable Unit (CRU) parts only (with limited onsite service for selected parts³, 8 am - 5 pm, Mon - Fri coverage excluding holidays, next business day response time) ↪ Onsite service upgrade options (in eligible locations)⁷ • 4-year LOR 9x5, Next Business Day (ThinkPlus part number 41C9194) • 4-year LOR 9x5, 4 hour response (ThinkPlus part number 41C9195) • 4-year LOR 24x7, 4 hour response (ThinkPlus part number 41C9196) ↪ ThinkPlus services at lenovo.com/thinkplus/warranty ↪ Post warranty maintenance services available ↪ 24 hour x 7 day¹⁴ toll-free support during the warranty period¹ via 800-426-7378 			

See footnotes for important warranty information
US model announced March 18, 2008

ThinkCentre® M57e Desktop (9481)

Personal Systems Reference (PSREF)

Name	Type-model	Slot x bay	Processor	GHz	L2 cache	Core	Memory ^a	SATA disk	SATA optical	Graphics	Preload	Limited warranty ¹	Global Educ	Avail date
M57e	9481-A1U	4x3	Celeron 420	1.60	512KB	Single	1GB	160GB ²	DVD	GMA	XP Pro	3-yr	None	Mar 08
M57e	9481-A6U	4x3	Pentium E2160	1.80	1MB	Dual	1GB	160GB	Combo	GMA	XP Pro	3-yr	None	Mar 08
M57e	9481-A2U	4x3	Core 2 Duo E4500	2.20	2MB	Dual	1GB	160GB	Combo	GMA	XP Pro	3-yr	None	Mar 08
M57e	9481-A7U	4x3	Core 2 Duo E6550	2.33	4MB	Dual	1GB	160GB	DVD±RW	GMA	XP Pro	3-yr	None	Mar 08
M57e	9481-BAU	4x3	Core 2 Duo E8200	2.66	6MB	Dual	1GB	160GB	Combo	GMA	XP Pro	3-yr	None	Mar 08

Positioning Processor	<p><i>Mainstream enterprise stability and manageability</i></p> <p>Intel® Celeron® Processor 420 with single-core, Intel 64 Tech, Execute Disable Bit, 800MHz system bus, and 512KB L2 cache or Intel Pentium® Dual-Core Processor E2160 with dual-core, Intel 64 Technology, Execute Disable Bit, EIST, 800MHz system bus, and 1MB shared L2 cache or Intel Core™ 2 Duo Processor E4500 with dual-core, Intel 64 Technology, Execute Disable Bit, EIST, 800MHz system bus, and 2MB shared L2 cache or Intel Core 2 Duo Processor E6550 with dual-core, Intel 64 Technology, Virtualization Technology, Execute Disable Bit, EIST, TXT, 1333MHz system bus, and 4MB shared L2 cache or Intel Core 2 Duo Processor E8200 with dual-core, Intel 64 Technology, Virtualization Technology, Execute Disable Bit, EIST, TXT, and 1333MHz system bus with 6MB shared L2 cache Processor in FC-LGA6 or FC-LGA8 package in LGA775 socket</p>	<p>Desktop</p> <ul style="list-style-type: none"> • Business black color • 13.0" W X 16.2" D X 4.1" H • 331mm W X 412mm D X 104mm H • 19.4 lb (8.8 kg) in max configuration • Toolless cover removal • Toolless disk, diskette drive, optical drive removal • Toolless adapter retention <p>Bay ① 5.25", 1.6" high, access, std optical Bay ② 3.5", 1" high, access, open (reader/diskette) Bay ③ 3.5", 1" high, no access, std disk</p> <p>Slot 1: Low Profile, PCI Express x16 (35w max) Slot 2: Low Profile, PCI Express x1 Slot 3: Low Profile, 32-bit PCI 2.3 Slot 4: Low Profile, 32-bit PCI 2.3</p>																																				
Implementation	Processor in FC-LGA6 or FC-LGA8 package in LGA775 socket																																					
Memory	<p>1GB std, 4GB max^a, PC2-5300 667MHz DDR2, non-parity, dual-channel capable, two 240-pin DIMM sockets; <i>Non-italics</i>: standard memory in one socket; one socket available</p>																																					
Graphics	<p>Intel Graphics Media Accelerator 3100 (GMA 3100), integrated graphics in G31, uses main memory (up to 256MB), one analog VGA DB-15 connector, supports dual independent display with optional ADD2 adapter</p>	<p>Security</p> <ul style="list-style-type: none"> • One lock to secure both cover and entire system to fixed object: <ul style="list-style-type: none"> - Padlock loop (in rear for opt padlock) - Security slot (in rear for optional Kensington® Microsaver® cable) • Power-on password • Administrator password • Hard disk password • Boot sequence control • Boot without keyboard, mouse, diskette • Serial port I/O control • Parallel port I/O control • USB port disablement 																																				
SATA disk	<p>160GB, SATA 3.0Gb/s 7200 rpm, vibration dampening mounts</p>																																					
SATA controller	Serial ATA, SATA 3.0Gb/s, integrated in ICH7																																					
SATA DVD	<i>Some</i> : DVD-ROM DL SATA 1.5Gb/s 16X-48X Max ⁴ Drive (41N5618)																																					
SATA Combo	<i>Some</i> : CD-RW/DVD-ROM Combo SATA 1.5Gb/s Drive																																					
SATA DVD±RW	<i>Some</i> : Super Multi-Burner DL DVD±RW SATA 1.5Gb/s Drive (41N5620)																																					
SATA cables	Two SATA cables (each 1-drop to device), four SATA connectors on planar																																					
eSATA port	None																																					
EIDE controller	Enhanced IDE, ATA-100, integrated in ICH7, one EIDE connector on planar																																					
Diskette drive	None																																					
Media reader	None																																					
Chipset	<p>Intel G31 Express Chipset; I/O Controller Hub 7 (ICH7) for SATA 3.0Gb/s, ATA-100 EIDE, PCI Express® x1, PCI 2.3, USB, LPC bus / ITE Tech® IT8718 Super I/O for serial, parallel, keyboard, mouse functions</p>																																					
Front ports	Two USB 2.0, microphone (stereo, 3.5mm), headphone (stereo, 3.5mm)																																					
Rear ports	Four USB 2.0, serial (9-pin), parallel (25-pin), keyboard (PS/2), mouse (PS/2), ethernet (RJ-45), monitor (VGA DB-15)																																					
Internal connector	Two USB 2.0 planar connectors (one used; one open for media reader)																																					
Rear audio ports	Line-in (stereo, 3.5mm), line-out (stereo, 3.5mm), microphone (stereo, 3.5mm)																																					
Audio	High Definition (HD) Audio, Realtek® ALC662 codec																																					
Speaker	One internal speaker for business audio																																					
Ethernet	Gigabit ethernet on planar, Marvell® 88E8056, PCIe x1, Wake on LAN®																																					
Intel AMT	None																																					
Modem	None																																					
Security chip	None																																					
Keyboard	Preferred Pro USB Keyboard (USB connector), 104-key, black, Lenovo logo																																					
Mouse	Optical Wheel Mouse (USB connector), 400 dpi, black, Lenovo logo																																					
Power supply	220 watts with variable speed fan, manual switch																																					
Preloaded operating system²⁰	<p>- Microsoft® Windows® XP Professional with Vista® COA</p> <p>◆ Disk-to-Disk Recovery (in hidden protected area)</p>	<p>Accessories</p> <table border="0"> <tr><td>1GB PC2-5300 CL5 NP DDR2 UDIMM</td><td>73P4984</td></tr> <tr><td>2GB PC2-5300 CL5 NP DDR2 UDIMM</td><td>73P4985</td></tr> <tr><td>1GB PC2-6400 NP DDR2 UDIMM</td><td>41U2977</td></tr> <tr><td>2GB PC2-6400 NP DDR2 UDIMM</td><td>41U2978</td></tr> <tr><td>500GB SATA 3.0Gb/s Disk (7200 rpm)</td><td>43R1990</td></tr> <tr><td>USB 2.0 Lenovo Multimedia Headset</td><td>40Y8518</td></tr> <tr><td>USB 2.0 Lenovo Webcam</td><td>40Y8519</td></tr> <tr><td>USB 2.0 Essential Memory Key 32GB</td><td>45K1258</td></tr> <tr><td>USB 2.0 Ultra Secure Memory Key 8GB</td><td>45J5918</td></tr> <tr><td>USB 2.0 Portable Secure 320GB Hard Disk</td><td>43R2019</td></tr> <tr><td>ThinkVision® L2440p Wide 24" Monitor</td><td>4420HB2</td></tr> <tr><td>Wireless Kbd & Opt Wheel Mouse (via USB)</td><td>73P4067</td></tr> <tr><td>Kensington Cable Lock from Lenovo</td><td>73P2582</td></tr> <tr><td>ADD2 DVI-I PCIe Connection Adapter</td><td>73P2516</td></tr> <tr><td>ADD2 DVI-D Monitor Connection (HDCP)</td><td>43R1985</td></tr> <tr><td>ATI™ Radeon™ HD 2400 Pro 128MB</td><td>43R1961</td></tr> <tr><td>ATI Radeon HD 2400 XT 256MB</td><td>43R1962</td></tr> <tr><td>NVIDIA® Quadro® 256MB NVS 290</td><td>43R1765</td></tr> </table> <p>Acc Guide in pdf lenovo.com/accessoriesguide Other accessories at lenovo.com/accessories</p>	1GB PC2-5300 CL5 NP DDR2 UDIMM	73P4984	2GB PC2-5300 CL5 NP DDR2 UDIMM	73P4985	1GB PC2-6400 NP DDR2 UDIMM	41U2977	2GB PC2-6400 NP DDR2 UDIMM	41U2978	500GB SATA 3.0Gb/s Disk (7200 rpm)	43R1990	USB 2.0 Lenovo Multimedia Headset	40Y8518	USB 2.0 Lenovo Webcam	40Y8519	USB 2.0 Essential Memory Key 32GB	45K1258	USB 2.0 Ultra Secure Memory Key 8GB	45J5918	USB 2.0 Portable Secure 320GB Hard Disk	43R2019	ThinkVision® L2440p Wide 24" Monitor	4420HB2	Wireless Kbd & Opt Wheel Mouse (via USB)	73P4067	Kensington Cable Lock from Lenovo	73P2582	ADD2 DVI-I PCIe Connection Adapter	73P2516	ADD2 DVI-D Monitor Connection (HDCP)	43R1985	ATI™ Radeon™ HD 2400 Pro 128MB	43R1961	ATI Radeon HD 2400 XT 256MB	43R1962	NVIDIA® Quadro® 256MB NVS 290	43R1765
1GB PC2-5300 CL5 NP DDR2 UDIMM	73P4984																																					
2GB PC2-5300 CL5 NP DDR2 UDIMM	73P4985																																					
1GB PC2-6400 NP DDR2 UDIMM	41U2977																																					
2GB PC2-6400 NP DDR2 UDIMM	41U2978																																					
500GB SATA 3.0Gb/s Disk (7200 rpm)	43R1990																																					
USB 2.0 Lenovo Multimedia Headset	40Y8518																																					
USB 2.0 Lenovo Webcam	40Y8519																																					
USB 2.0 Essential Memory Key 32GB	45K1258																																					
USB 2.0 Ultra Secure Memory Key 8GB	45J5918																																					
USB 2.0 Portable Secure 320GB Hard Disk	43R2019																																					
ThinkVision® L2440p Wide 24" Monitor	4420HB2																																					
Wireless Kbd & Opt Wheel Mouse (via USB)	73P4067																																					
Kensington Cable Lock from Lenovo	73P2582																																					
ADD2 DVI-I PCIe Connection Adapter	73P2516																																					
ADD2 DVI-D Monitor Connection (HDCP)	43R1985																																					
ATI™ Radeon™ HD 2400 Pro 128MB	43R1961																																					
ATI Radeon HD 2400 XT 256MB	43R1962																																					
NVIDIA® Quadro® 256MB NVS 290	43R1765																																					
		<p>Supports ThinkVantage® technologies</p> <p>RoHS-compliant</p> <p>Limited Warranty¹</p> <ul style="list-style-type: none"> ⇒ 3-year parts and labor ⇒ International Warranty Service⁹ ⇒ Customer Replaceable Unit (CRU) parts only (with limited onsite service for selected parts³, 8 am - 5 pm, Mon - Fri coverage excluding holidays, next business day response time) ⇒ Onsite service upgrade options (in eligible locations):⁷ <ul style="list-style-type: none"> • 3-year LOR 9x5, 4 hour response (ThinkPlus™ part number 41C9192) • 3-year LOR 24x7, 4 hour response (ThinkPlus part number 41C9193) • 4-year LOR 9x5, Next Business Day (ThinkPlus part number 41C9194) • 4-year LOR 9x5, 4 hour response (ThinkPlus part number 41C9195) • 4-year LOR 24x7, 4 hour response (ThinkPlus part number 41C9196) ⇒ ThinkPlus services at lenovo.com/thinkplus/warranty ⇒ Post warranty maintenance services available ⇒ 24 hour x 7 day¹⁴ toll-free support during the warranty period¹ via 800-426-7378 																																				

See footnotes for important warranty information

Ⓜ US model announced March 18, 2008; previous models on February 26, 2008

Ⓜ US model withdrawn effective September 2008

© Lenovo

(MONA1-5) March 2008

Name	Type-model	Slot x bay	Processor	GHz	L2 cache	Core	Memory ^a	SATA disk	SATA optical	Graphics	Preload	Limited warranty ¹	Global Educ	Avail date
M57e	9481-J1U	4x3	Pentium E2180	2.00	1MB	Dual	1GB	160GB ^b	DVD	GMA	XP Pro	3-yr	None	Aug 08
M57e	9481-J2U	4x3	Pentium E2180	2.00	1MB	Dual	1GB	160GB	DVD±RW	GMA+ADD2	XP Pro	3-yr	None	Aug 08
M57e	9481-J3U	4x3	Pentium E2200	2.20	1MB	Dual	1GB	160GB	DVD	GMA	XP Pro	3-yr	None	Aug 08
M57e	9481-J4U	4x3	Pentium E2200	2.20	1MB	Dual	2GB	160GB	DVD±RW	GMA	XP Pro	3-yr	None	Aug 08
M57e	9481-J6U	4x3	Core 2 Duo E7200	2.53	3MB	Dual	2GB	160GB	DVD	GMA	XP Pro	3-yr	None	Aug 08
M57e	9481-J5U	4x3	Core 2 Duo E7200	2.53	3MB	Dual	2GB	160GB	DVD±RW	GMA+ADD2	XP Pro	3-yr	None	Aug 08
M57e	9481-J7U	4x3	Core 2 Duo E7300	2.66	3MB	Dual	1GB	160GB	DVD±RW	GMA	XP Pro	3-yr	None	Aug 08

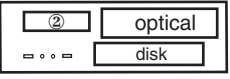
Positioning Processor	<p><i>Mainstream enterprise stability and manageability</i> Intel® Pentium® Dual-Core Processor E2180 or E2200 with dual-core, Intel 64 Technology, Execute Disable Bit, EIST, 800MHz system bus, and 1MB L2 cache or Intel Core™ 2 Duo Processor E7200 or E7300 with dual-core, Intel 64 Technology, Execute Disable Bit, EIST, and 1066MHz system bus with 3MB L2 cache Processor in FC-LGA6 or FC-LGA8 package in LGA775 socket</p>							<p>Desktop</p>  <ul style="list-style-type: none"> • Business black color • 13.0" W X 16.2" D X 4.1" H • 331mm W X 412mm D X 104mm H • 19.4 lb (8.8 kg) in max configuration • Toolless cover removal • Toolless disk, diskette drive, optical drive removal • Toolless adapter retention <p>Bay ① 5.25", 1.6" high, access, std optical Bay ② 3.5", 1" high, access, open (reader/diskette) Bay ③ 3.5", 1" high, no access, std disk</p> <p>Slot 1: Low Profile, PCI Express x16 (35w max)* Slot 2: Low Profile, PCI Express x1 Slot 3: Low Profile, 32-bit PCI 2.3 Slot 4: Low Profile, 32-bit PCI 2.3</p> <p>* used in some models</p>																																																		
Implementation	Processor in FC-LGA6 or FC-LGA8 package in LGA775 socket																																																									
Memory	<p>1GB or 2GB std, 4GB max^a, PC2-5300 667MHz DDR2, non-parity, dual-channel capable, two 240-pin DIMM sockets; <i>Non-italics:</i> standard memory in one socket; one socket available</p>																																																									
Graphics	<p><i>All:</i> Intel Graphics Media Accelerator 3100 (GMA 3100), integrated graphics in G31, uses main memory (up to 256MB), one analog VGA DB-15 connector <i>Some:</i> ADD2 DVI-D Monitor Connection (HDCP), PCI Express[®] adapter in PCIe x16 slot, provides DVI-D connector to support second monitor, HDCP-compliant</p>																																																									
SATA disk	<p>160GB, SATA 3.0Gb/s 7200 rpm, vibration dampening mounts</p>																																																									
SATA controller	Serial ATA, SATA 3.0Gb/s, integrated in ICH7																																																									
SATA DVD	<i>Some:</i> DVD-ROM DL SATA 1.5Gb/s 16X-48X Max ⁴ Drive (41N5618)																																																									
SATA DVD±RW	<i>Some:</i> Super Multi-Burner DL DVD±RW SATA 1.5Gb/s Drive (41N5620)																																																									
SATA cables	Two SATA cables (each 1-drop to device), four SATA connectors on planar																																																									
eSATA port	None																																																									
EIDE controller	Enhanced IDE, ATA-100, integrated in ICH7, one EIDE connector on planar																																																									
Diskette drive	None																																																									
Media reader	None																																																									
Chipset	<p>Intel G31 Express Chipset; I/O Controller Hub 7 (ICH7) for SATA 3.0Gb/s, ATA-100 EIDE, PCI Express x1, PCI 2.3, USB, LPC bus / ITE Tech[®] IT8718 Super I/O for serial, parallel, keyboard, mouse functions</p>							<p>Security</p> <ul style="list-style-type: none"> • One lock to secure both cover and entire system to fixed object: <ul style="list-style-type: none"> - Padlock loop (in rear for opt padlock) - Security slot (in rear for optional Kensington[®] Microsaver[®] cable) • Power-on password • Administrator password • Hard disk password • Boot sequence control • Boot without keyboard, mouse, diskette • Serial port I/O control • Parallel port I/O control • USB port disablement 																																																		
Front ports	Two USB 2.0, microphone (stereo, 3.5mm), headphone (stereo, 3.5mm)																																																									
Rear ports	Four USB 2.0, serial (9-pin), parallel (25-pin), keyboard (PS/2), mouse (PS/2), ethernet (RJ-45), monitor (VGA DB-15, DVI-D in some models)																																																									
Internal connector	Two USB 2.0 planar connectors (one used; one open for media reader)																																																									
Rear audio ports	Line-in (stereo, 3.5mm), line-out (stereo, 3.5mm), microphone (stereo, 3.5mm)																																																									
Audio	High Definition (HD) Audio, Realtek [®] ALC662 codec																																																									
Speaker	One internal speaker for business audio																																																									
Ethernet	Gigabit ethernet on planar, Marvell [®] 88E8056, PCIe x1, Wake on LAN [®]																																																									
Intel AMT	None																																																									
Modem	None																																																									
Security chip	None																																																									
Keyboard	Preferred Pro USB Keyboard (USB connector), 104-key, black, Lenovo logo																																																									
Mouse	Optical Wheel Mouse (USB connector), 400 dpi, black, Lenovo logo																																																									
Power supply	220 watts with variable speed fan, manual switch																																																									
Preloaded operating system²⁰	<p>- Microsoft[®] Windows[®] XP Professional with Vista[®] COA ♦ Disk-to-Disk Recovery (in hidden protected area)</p>							<p>Accessories</p> <table border="0"> <tr><td>1GB PC2-5300 CL5 NP DDR2 UDIMM</td><td>73P4984</td></tr> <tr><td>2GB PC2-5300 CL5 NP DDR2 UDIMM</td><td>73P4985</td></tr> <tr><td>1GB PC2-6400 NP DDR2 UDIMM</td><td>41U2977</td></tr> <tr><td>2GB PC2-6400 NP DDR2 UDIMM</td><td>41U2978</td></tr> <tr><td>250GB SATA 3.0Gb/s Disk (7200 rpm)</td><td>41N3015</td></tr> <tr><td>500GB SATA 3.0Gb/s Disk (7200 rpm)</td><td>43R1990</td></tr> <tr><td>USB 2.0 Lenovo Multimedia Headset</td><td>40Y8518</td></tr> <tr><td>USB 2.0 Lenovo Webcam</td><td>40Y8519</td></tr> <tr><td>USB 2.0 Essential Memory Key 32GB</td><td>45K1258</td></tr> <tr><td>USB 2.0 Ultra Secure Memory Key 8GB</td><td>45J5918</td></tr> <tr><td>USB 2.0 Portable 160GB Hard Disk</td><td>43R1784</td></tr> <tr><td>USB 2.0 Portable Secure 320GB Hard Disk</td><td>43R2019</td></tr> <tr><td>ThinkVision[®] L2240p Wide 22" Monitor</td><td>4422HB6</td></tr> <tr><td>ThinkVision L2440p Wide 24" Monitor</td><td>4420HB2</td></tr> <tr><td>Wireless Kbd & Opt Wheel Mouse (via USB)</td><td>73P4067</td></tr> <tr><td>Laser Tilt Wheel Mouse (USB, PS/2)</td><td>41U3074</td></tr> <tr><td>Kensington Cable Lock from Lenovo</td><td>73P2582</td></tr> <tr><td>ADD2 DVI-I PCIe Connection Adapter</td><td>73P2516</td></tr> <tr><td>ADD2 DVI-D Monitor Connection (HDCP)</td><td>43R1985</td></tr> <tr><td>ATI[™] Radeon[™] HD 2400 Pro 128MB</td><td>43R1961</td></tr> <tr><td>ATI Radeon HD 2400 XT 256MB</td><td>43R1962</td></tr> <tr><td>NVIDIA[®] Quadro[®] 256MB NVS 290</td><td>43R1765</td></tr> </table> <p>Acc Guide in pdf lenovo.com/accessoriesguide Other accessories at lenovo.com/accessories</p>							1GB PC2-5300 CL5 NP DDR2 UDIMM	73P4984	2GB PC2-5300 CL5 NP DDR2 UDIMM	73P4985	1GB PC2-6400 NP DDR2 UDIMM	41U2977	2GB PC2-6400 NP DDR2 UDIMM	41U2978	250GB SATA 3.0Gb/s Disk (7200 rpm)	41N3015	500GB SATA 3.0Gb/s Disk (7200 rpm)	43R1990	USB 2.0 Lenovo Multimedia Headset	40Y8518	USB 2.0 Lenovo Webcam	40Y8519	USB 2.0 Essential Memory Key 32GB	45K1258	USB 2.0 Ultra Secure Memory Key 8GB	45J5918	USB 2.0 Portable 160GB Hard Disk	43R1784	USB 2.0 Portable Secure 320GB Hard Disk	43R2019	ThinkVision [®] L2240p Wide 22" Monitor	4422HB6	ThinkVision L2440p Wide 24" Monitor	4420HB2	Wireless Kbd & Opt Wheel Mouse (via USB)	73P4067	Laser Tilt Wheel Mouse (USB, PS/2)	41U3074	Kensington Cable Lock from Lenovo	73P2582	ADD2 DVI-I PCIe Connection Adapter	73P2516	ADD2 DVI-D Monitor Connection (HDCP)	43R1985	ATI [™] Radeon [™] HD 2400 Pro 128MB	43R1961	ATI Radeon HD 2400 XT 256MB	43R1962	NVIDIA [®] Quadro [®] 256MB NVS 290	43R1765
1GB PC2-5300 CL5 NP DDR2 UDIMM	73P4984																																																									
2GB PC2-5300 CL5 NP DDR2 UDIMM	73P4985																																																									
1GB PC2-6400 NP DDR2 UDIMM	41U2977																																																									
2GB PC2-6400 NP DDR2 UDIMM	41U2978																																																									
250GB SATA 3.0Gb/s Disk (7200 rpm)	41N3015																																																									
500GB SATA 3.0Gb/s Disk (7200 rpm)	43R1990																																																									
USB 2.0 Lenovo Multimedia Headset	40Y8518																																																									
USB 2.0 Lenovo Webcam	40Y8519																																																									
USB 2.0 Essential Memory Key 32GB	45K1258																																																									
USB 2.0 Ultra Secure Memory Key 8GB	45J5918																																																									
USB 2.0 Portable 160GB Hard Disk	43R1784																																																									
USB 2.0 Portable Secure 320GB Hard Disk	43R2019																																																									
ThinkVision [®] L2240p Wide 22" Monitor	4422HB6																																																									
ThinkVision L2440p Wide 24" Monitor	4420HB2																																																									
Wireless Kbd & Opt Wheel Mouse (via USB)	73P4067																																																									
Laser Tilt Wheel Mouse (USB, PS/2)	41U3074																																																									
Kensington Cable Lock from Lenovo	73P2582																																																									
ADD2 DVI-I PCIe Connection Adapter	73P2516																																																									
ADD2 DVI-D Monitor Connection (HDCP)	43R1985																																																									
ATI [™] Radeon [™] HD 2400 Pro 128MB	43R1961																																																									
ATI Radeon HD 2400 XT 256MB	43R1962																																																									
NVIDIA [®] Quadro [®] 256MB NVS 290	43R1765																																																									
Preloaded applications⁵	<ul style="list-style-type: none"> • Rescue and Recovery[™] • Client Security Solution[™] • ThinkVantage Productivity Center • ThinkVantage System Update • System Migration Assistant • Norton Internet Security[™] • Diskkeeper[®] Home • PC-Doctor[™] (diagnostics) • Adobe[®] Reader • Windows Live[™] Toolbar • Windows Live Search • Picasa from Google • Microsoft Office 2007 Trial (60-day) • Multimedia Center for Think Offerings (DVD, DVD±RW) • Sonic RecordNow and Drive Letter Access (DVD±RW) • Corel[®] WinDVD[®] (DVD, DVD±RW) • Corel WinDVD Creator (DVD±RW) 							<p>⇒ 3-year parts and labor</p> <p>⇒ International Warranty Service⁹</p> <p>⇒ Customer Replaceable Unit (CRU) parts only (with limited onsite service for selected parts³, 8 am - 5 pm, Mon - Fri coverage excluding holidays, next business day response time)</p> <p>⇒ Onsite service upgrade options (in eligible locations):⁷</p> <ul style="list-style-type: none"> • 3-year LOR 9x5, 4 hour response (ThinkPlus[™] part number 41C9192) • 3-year LOR 24x7, 4 hour response (ThinkPlus part number 41C9193) • 4-year LOR 9x5, Next Business Day (ThinkPlus part number 41C9194) • 4-year LOR 9x5, 4 hour response (ThinkPlus part number 41C9195) • 4-year LOR 24x7, 4 hour response (ThinkPlus part number 41C9196) <p>⇒ ThinkPlus services at lenovo.com/thinkplus/warranty</p> <p>⇒ Post warranty maintenance services available</p> <p>⇒ 24 hour x 7 day¹⁴ toll-free support during the warranty period¹ via 800-426-7378</p>																																																		

See footnotes for important warranty information
 US models announced August 19, 2008

Name	Type-model	Slot x bay	Processor	GHz	L2 cache	Core	Memory ^a	SATA disk	SATA optical	Graphics	Vista preload	Limited warranty ¹	Global Educ	Avail date
M57e	9481-A5U	4x3	Celeron 420	1.60	512KB	Single	1GB	160GB ²	DVD	GMA	Business32	3-yr		Mar 08
M57e	9481-A4U	4x3	Pentium E2160	1.80	1MB	Dual	1GB	160GB	Combo	GMA	Business32	3-yr		Mar 08
M57e	9481-D5U	4x3	Pentium E2200	2.20	1MB	Dual	1GB	160GB	Combo	GMA	Business32	3-yr	Gbl	Mar 08
M57e	9481-A3U	4x3	Core 2 Duo E4500	2.20	2MB	Dual	1GB	160GB	Combo	GMA	Business32	3-yr		Mar 08
M57e	9481-D6U	4x3	Core 2 Duo E4600	2.40	2MB	Dual	1GB	160GB	Combo	GMA	Business32	3-yr	Gbl	Mar 08
M57e	9481-A8U	4x3	Core 2 Duo E6550	2.33	4MB	Dual	1GB	160GB	DVD±RW	GMA	Business32	3-yr		Mar 08
M57e	9481-A9U	4x3	Core 2 Duo E8200	2.66	6MB	Dual	1GB	160GB	Combo	GMA	Business32	3-yr	Gbl	Mar 08

Positioning Processor *Mainstream enterprise stability and manageability*
Intel® Celeron® Processor 420 with single-core, Intel 64 Tech, Execute Disable Bit, 800MHz system bus, and 512KB L2 cache or **Intel Pentium® Dual-Core Processor E2160 or E2200 with dual-core**, Intel 64 Technology, Execute Disable Bit, EIST, 800MHz system bus, and 1MB shared L2 cache or **Intel Core™ 2 Duo Processor E4500 or E4600 with dual-core**, Intel 64 Technology, Execute Disable Bit, EIST, 800MHz system bus, and 2MB shared L2 cache or **Intel Core 2 Duo Processor E6550 with dual-core**, Intel 64 Technology, Virtualization Technology, Execute Disable Bit, EIST, TXT, 1333MHz system bus, and 4MB shared L2 cache or **Intel Core 2 Duo Processor E8200 with dual-core**, Intel 64 Technology, Virtualization Technology, Execute Disable Bit, EIST, TXT, and 1333MHz system bus with 6MB shared L2 cache Processor in FC-LGA6 or FC-LGA8 package in LGA775 socket

Implementation Memory **1GB std, 4GB max⁸, PC2-5300 667MHz DDR2**, non-parity, dual-channel capable, two 240-pin DIMM sockets; *Non-italics*: standard memory in one socket; one socket available

Graphics **Intel Graphics Media Accelerator 3100 (GMA 3100)**, integrated graphics in G31, uses main memory (up to 256MB), one analog VGA DB-15 connector, supports dual independent display with optional ADD2 adapter

SATA disk **160GB**, SATA 3.0Gb/s 7200 rpm, vibration dampening mounts
SATA controller Serial ATA, SATA 3.0Gb/s, integrated in ICH7
SATA DVD *Some:* DVD-ROM DL SATA 1.5Gb/s 16X-48X Max⁴ Drive (41N5618)
SATA Combo *Some:* CD-RW/DVD-ROM Combo SATA 1.5Gb/s Drive
SATA DVD±RW *Some:* Super Multi-Burner DL DVD±RW SATA 1.5Gb/s Drive (41N5620)
SATA cables Two SATA cables (each 1-drop to device), four SATA connectors on planar
eSATA port None
EIDE controller Enhanced IDE, ATA-100, integrated in ICH7, one EIDE connector on planar
Diskette drive None
Media reader None

Chipset **Intel G31 Express Chipset**; I/O Controller Hub 7 (ICH7) for SATA 3.0Gb/s, ATA-100 EIDE, PCI Express[®] x1, PCI 2.3, USB, LPC bus / ITE Tech[®] IT8718 Super I/O for serial, parallel, keyboard, mouse functions

Front ports Two USB 2.0, microphone (stereo, 3.5mm), headphone (stereo, 3.5mm)
Rear ports Four USB 2.0, serial (9-pin), parallel (25-pin), keyboard (PS/2), mouse (PS/2), ethernet (RJ-45), monitor (VGA DB-15)
Internal connector Two USB 2.0 planar connectors (one used; one open for media reader)
Rear audio ports Line-in (stereo, 3.5mm), line-out (stereo, 3.5mm), microphone (stereo, 3.5mm)
Audio High Definition (HD) Audio, Realtek[®] ALC662 codec
Speaker One internal speaker for business audio
Ethernet Gigabit ethernet on planar, Marvell[®] 88E8056, PCIe x1, Wake on LAN[®]
Intel AMT None
Modem None
Security chip None

Keyboard Preferred Pro USB Keyboard (USB connector), 104-key, black, Lenovo logo
Mouse Optical Wheel Mouse (USB connector), 400 dpi, black, Lenovo logo
Power supply 220 watts with variable speed fan, manual switch

Preloaded operating system ²⁰	Accessories	
- Microsoft® Windows® Vista Business Edition (32-bit)	1GB PC2-5300 CL5 NP DDR2 UDIMM	73P4984
↕ Vista Basic logo	2GB PC2-5300 CL5 NP DDR2 UDIMM	73P4985
Preloaded applications⁵ (only some listed)	1GB PC2-6400 NP DDR2 UDIMM	41U2977
• Rescue and Recovery™	2GB PC2-6400 NP DDR2 UDIMM	41U2978
• Client Security Solution™	500GB SATA 3.0Gb/s Disk (7200 rpm)	43R1990
• ThinkVantage Productivity Center	USB 2.0 Lenovo Multimedia Headset	40Y8518
• ThinkVantage System Update	USB 2.0 Essential Memory Key 32GB	45K1258
• Norton Internet Security™	USB 2.0 Ultra Secure Memory Key 8GB	45J5918
• Diskeeper® Home	USB 2.0 Portable Secure 320GB Hard Disk	43R2019
• PC-Doctor™ (diagnostics)	ThinkVision® L2440p Wide 24" Monitor	4420HB2
• Picasa from Google	Wireless Kbd & Opt Wheel Mouse (via USB)	73P4067
• Microsoft Office 2007 Trial (60-day)	Kensington Cable Lock from Lenovo	73P2582
• Sonic RecordNow and Drive Letter Access (combo, DVD±RW)	ADD2 DVI-I PCIe Connection Adapter	73P2516
• Corel® WinDVD® (combo, DVD, DVD±RW)	ADD2 DVI-D Monitor Connection (HDCP)	43R1985
	ATI™ Radeon™ HD 2400 Pro 128MB	43R1961
	ATI Radeon HD 2400 XT 256MB	43R1962
	NVIDIA® Quadro® 256MB NVS 290	43R1765
	Other accessories at lenovo.com/accessories	

Desktop

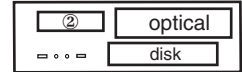

- Business black color
 - 13.0" W X 16.2" D X 4.1" H
 - 331mm W X 412mm D X 104mm H
 - 19.4 lb (8.8 kg) in max configuration
 - Toolless cover removal
 - Toolless disk, diskette drive, optical drive removal
 - Toolless adapter retention
- Bay ① 5.25", 1.6" high, access, std optical
 Bay ② 3.5", 1" high, access, open (reader/diskette)
 Bay ③ 3.5", 1" high, no access, std disk
- Slot 1: Low Profile, PCI Express x16 (35w max)
 Slot 2: Low Profile, PCI Express x1
 Slot 3: Low Profile, 32-bit PCI 2.3
 Slot 4: Low Profile, 32-bit PCI 2.3

Security

- One lock to secure both cover and entire system to fixed object:
 - Padlock loop (in rear for opt padlock)
 - Security slot (in rear for optional Kensington® Microsaver® cable)
- Power-on password
- Administrator password
- Hard disk password
- Boot sequence control
- Boot without keyboard, mouse, diskette
- Serial port I/O control
- Parallel port I/O control
- USB port disablement

Supports ThinkVantage® technologies

RoHS-compliant

Limited Warranty¹

- ↔ **3-year parts and labor**
- ↔ **International Warranty Service⁹**
- ↔ **Customer Replaceable Unit (CRU) parts only (with limited onsite service for selected parts³, 8 am - 5 pm, Mon - Fri coverage excluding holidays, next business day response time)**
- ↔ **Onsite service upgrade options (in eligible locations):⁷**
 - **3-year LOR 9x5, 4 hour response** (ThinkPlus™ part number 41C9192)
 - **3-year LOR 24x7, 4 hour response** (ThinkPlus part number 41C9193)
 - **4-year LOR 9x5, Next Business Day** (ThinkPlus part number 41C9194)
 - **4-year LOR 9x5, 4 hour response** (ThinkPlus part number 41C9195)
 - **4-year LOR 24x7, 4 hour response** (ThinkPlus part number 41C9196)
- ↔ **ThinkPlus services at lenovo.com/thinkplus/warranty**
- ↔ **Post warranty maintenance services available**
- ↔ **24 hour x 7 day¹⁴ toll-free support during the warranty period¹ via 800-426-7378**

See footnotes for important warranty information

☞ US models announced March 18, 2008; previous models on February 19, 2008

⊗ US model withdrawn effective September 2008

Name	Type-model	Slot x bay	Processor	GHz	L2 cache	Core	Memory ⁸	SATA disk	SATA optical	Graphics	Vista preload	Limited warranty ¹	Global Educ	Avail date
M57e	9481-F2U	4x3	Core 2 Duo E7200	2.53	3MB	Dual	1GB	160GB ²	DVD±RW	GMA	Business32	3-yr	None	Jun 08

• *This model has a 3-year limited warranty¹*

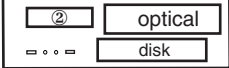
Positioning Processor	Mainstream enterprise stability and manageability Intel® Core™ 2 Duo Processor E7200 with dual-core, Intel 64 Technology, Execute Disable Bit, EIST, and 1066MHz system bus with 3MB L2 cache		Desktop	
Implementation	Processor in FC-LGA8 package in LGA775 socket		<ul style="list-style-type: none"> Business black color 13.0" W X 16.2" D X 4.1" H 331mm W X 412mm D X 104mm H 19.4 lb (8.8 kg) in max configuration Toolless cover removal Toolless disk, diskette drive, optical drive removal Toolless adapter retention 	
Memory	1GB std , 4GB max ⁹ , PC2-5300 667MHz DDR2 , non-parity, dual-channel capable, two 240-pin DIMM sockets; <i>Non-italics</i> : standard memory in one socket; one socket available		<ul style="list-style-type: none"> Bay ① 5.25", 1.6" high, access, std optical Bay ② 3.5", 1" high, access, open (reader/diskette) Bay ③ 3.5", 1" high, no access, std disk 	
Graphics	Intel Graphics Media Accelerator 3100 (GMA 3100) , integrated graphics in G31, uses main memory (up to 256MB), one analog VGA DB-15 connector, supports dual independent display with optional ADD2 adapter		<ul style="list-style-type: none"> Slot 1: Low Profile, PCI Express x16 (35w max) Slot 2: Low Profile, PCI Express x1 Slot 3: Low Profile, 32-bit PCI 2.3 Slot 4: Low Profile, 32-bit PCI 2.3 	
SATA disk	160GB , SATA 3.0Gb/s 7200 rpm, vibration dampening mounts			
SATA controller	Serial ATA, SATA 3.0Gb/s, integrated in ICH7			
SATA DVD±RW	Super Multi-Burner DL DVD±RW SATA 1.5Gb/s Drive (41N5620)			
SATA cables	Two SATA cables (each 1-drop to device), four SATA connectors			
eSATA port	None			
EIDE controller	Enhanced IDE, ATA-100, integrated in ICH7, one EIDE connector on planar			
Diskette drive	None			
Media reader	None			
Chipset	Intel G31 Express Chipset ; I/O Controller Hub 7 (ICH7) for SATA 3.0Gb/s, ATA-100 EIDE, PCI Express [®] x1, PCI 2.3, USB, LPC bus / ITE Tech [®] IT8718 Super I/O for serial, parallel, keyboard, mouse functions			
Front ports	Two USB 2.0, microphone (stereo, 3.5mm), headphone (stereo, 3.5mm)			
Rear ports	Four USB 2.0, serial (9-pin), parallel (25-pin), keyboard (PS/2), mouse (PS/2), ethernet (RJ-45), monitor (VGA DB-15)			
Internal connector	Two USB 2.0 planar connectors (one used; one open for media reader)			
Rear audio ports	Line-in (stereo, 3.5mm), line-out (stereo, 3.5mm), microphone (stereo, 3.5mm)			
Audio	High Definition (HD) Audio, Realtek [®] ALC662 codec			
Speaker	One internal speaker for business audio			
Ethernet	Gigabit ethernet on planar, Marvell [®] 88E8056, PCIe x1, Wake on LAN [®]			
Intel AMT	None			
Modem	None			
Security chip	None			
Keyboard	Preferred Pro USB Keyboard (USB connector), 104-key, black, Lenovo logo			
Mouse	Optical Wheel Mouse (USB connector), 400 dpi, black, Lenovo logo			
Power supply	220 watts with variable speed fan, manual switch			
Preloaded operating system²⁰	<ul style="list-style-type: none"> Microsoft[®] Windows[®] Vista Business Edition (32-bit) Vista Basic logo 			
Preloaded applications⁵	<ul style="list-style-type: none"> Rescue and Recovery[™] Client Security Solution[™] ThinkVantage Productivity Center ThinkVantage System Update System Migration Assistant Norton Internet Security[™] (90 days of virus definitions) Diskeeper[®] Home PC-Doctor[™] (diagnostics) Adobe[®] Reader Windows Live[™] Toolbar Windows Live Search Picasa from Google Microsoft Office 2007 Trial (60-day) Sonic RecordNow and Drive Letter Access (DVD±RW) Corel[®] WinDVD[®] (DVD±RW) 			
Accessories	<ul style="list-style-type: none"> 1GB PC2-5300 CL5 NP DDR2 UDIMM 73P4984 2GB PC2-5300 CL5 NP DDR2 UDIMM 73P4985 1GB PC2-6400 NP DDR2 UDIMM 41U2977 2GB PC2-6400 NP DDR2 UDIMM 41U2978 250GB SATA 3.0Gb/s Disk (7200 rpm) 41N3015 500GB SATA 3.0Gb/s Disk (7200 rpm) 43R1990 USB Portable Diskette Drive 05K9276 USB 2.0 Lenovo Multimedia Headset 40Y8518 USB 2.0 Lenovo Webcam 40Y8519 USB 2.0 Essential Memory Key 32GB 45K1258 USB 2.0 Security Memory Key 2GB 41U5119 USB 2.0 Security Memory Key 4GB 41U5120 USB 2.0 Ultra Secure Memory Key 2GB 45J5916 USB 2.0 Ultra Secure Memory Key 4GB 45J5917 USB 2.0 Ultra Secure Memory Key 8GB 45J5918 USB 2.0 Portable 160GB Hard Disk 43R1784 USB 2.0 Portable Secure 320GB Hard Disk 43R2019 ThinkVision[®] L1700p 17" Monitor 9417HE2 ThinkVision L1940p Wide 19" Monitor 4424HB6 ThinkVision L2240p Wide 22" Monitor 4422HB6 ThinkVision L2440p Wide 24" Monitor 4420HB2 Wireless Kbd & Opt Wheel Mouse (via USB) 73P4067 Laser Tilt Wheel Mouse (USB, PS/2) 41U3074 Kensington Cable Lock from Lenovo 73P2582 ADD2 DVI-I PCIe Connection Adapter 73P2516 ADD2 DVI-D Monitor Connection (HDCP) 43R1985 ATI[™] Radeon[™] HD 2400 Pro 128MB 43R1961 ATI Radeon HD 2400 XT 256MB 43R1962 NVIDIA[®] Quadro[®] 256MB NVS 290 43R1765 Acc Guide in pdf lenovo.com/accessoriesguide Other accessories at lenovo.com/accessories 			
				Supports ThinkVantage [®] technologies
				RoHS-compliant
				<p>Limited Warranty¹</p> <ul style="list-style-type: none"> 3-year parts and labor International Warranty Service⁹ Customer Replaceable Unit (CRU) parts only (with limited onsite service for selected parts³, 8 am - 5 pm, Mon - Fri coverage excluding holidays, next business day response time) Onsite service upgrade options (in eligible locations):⁷ <ul style="list-style-type: none"> 3-year LOR 9x5, 4 hour response (ThinkPlus[™] part number 41C9192) 3-year LOR 24x7, 4 hour response (ThinkPlus part number 41C9193) 4-year LOR 9x5, Next Business Day (ThinkPlus part number 41C9194) 4-year LOR 9x5, 4 hour response (ThinkPlus part number 41C9195) 4-year LOR 24x7, 4 hour response (ThinkPlus part number 41C9196) ThinkPlus services at lenovo.com/thinkplus/warranty Post warranty maintenance services available 24 hour x 7 day¹⁴ toll-free support during the warranty period¹ via 800-426-7378

See footnotes for important warranty information
US model announced June 24, 2008

Name	Type-model	Slot x bay	Processor	GHz	L2 cache	Cores	Memory ⁸	SATA disk	SATA optical	Graphics	Vista preload	Vista logo	Global Educ	Avail date
M57e	9481-JCU	4x3	Pentium E5200	2.50	2MB	2	1GB	160GB ²	DVD	GMA	Business32	Premium	None	Nov 08
M57e	9481-JDU	4x3	Pentium E5200	2.50	2MB	2	1GB	250GB	DVD±RW	GMA	Business32	Premium	None	Nov 08

• These models have a 3-year limited warranty¹

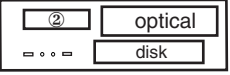
Positioning Processor	Mainstream enterprise stability and manageability Intel® Pentium® Dual-Core Processor E5200 with dual-core, 800MHz system bus, and 2MB L2 cache		Desktop 
Implementation	Processor in FC-LGA6 package in LGA775 socket		
Memory	1GB std , 4GB max ⁸ , PC2-5300 667MHz DDR2 , non-parity, dual-channel capable, two 240-pin DIMM sockets; <i>Non-italics</i> : standard memory in one socket; one socket available		<ul style="list-style-type: none"> • Business black color • 13.0" W X 16.2" D X 4.1" H • 331mm W X 412mm D X 104mm H • 19.4 lb (8.8 kg) in max configuration • Toolless cover removal • Toolless disk, diskette drive, optical drive removal • Toolless adapter retention
Graphics	Intel Graphics Media Accelerator 3100 (GMA 3100) , integrated graphics in G31, uses main memory (up to 256MB), one analog VGA DB-15 connector, supports dual independent display with optional ADD2 adapter		<ul style="list-style-type: none"> • Bay ① 5.25", 1.6" high, access, std optical • Bay ② 3.5", 1" high, access, open (reader/diskette) • Bay ③ 3.5", 1" high, no access, std disk
SATA disk	160GB or 250GB , SATA 3.0Gb/s 7200 rpm, vibration dampening		Slot 1: Low Profile, PCI Express x16 (35w max) Slot 2: Low Profile, PCI Express x1 Slot 3: Low Profile, 32-bit PCI 2.3 Slot 4: Low Profile, 32-bit PCI 2.3
SATA controller	Serial ATA, SATA 3.0Gb/s, integrated in ICH7		
SATA DVD	<i>Some</i> : DVD-ROM DL SATA 1.5Gb/s 16-48X Max ⁴ Drive (41N5618)		Security <ul style="list-style-type: none"> • One lock to secure both cover and entire system to fixed object: <ul style="list-style-type: none"> - Padlock loop (in rear for opt padlock) - Security slot (in rear for optional Kensington® Microsaver® cable) • Power-on password • Administrator password • Hard disk password • Boot sequence control • Boot without keyboard, mouse, diskette • Serial port I/O control • Parallel port I/O control • USB port disablement
SATA DVD±RW	<i>Some</i> : Super Multi-Burner DL DVD±RW SATA Drive (41N5620)		
SATA cables	Two SATA cables (each 1-drop to device), four SATA connectors		
eSATA port	None		
EIDE controller	Enhanced IDE, ATA-100, integrated in ICH7, one EIDE connector on planar		
Diskette drive	None		
Media reader	None		
Chipset	Intel G31 Express Chipset ; I/O Controller Hub 7 (ICH7) for SATA 3.0Gb/s, ATA-100 EIDE, PCI Express [®] x1, PCI 2.3, USB, LPC bus / ITE Tech [®] IT8718 Super I/O for serial, parallel, keyboard, mouse functions		
Front ports	Two USB 2.0, microphone (stereo, 3.5mm), headphone (stereo, 3.5mm)		
Rear ports	Four USB 2.0, serial (9-pin), parallel (25-pin), keyboard (PS/2), mouse (PS/2), ethernet (RJ-45), monitor (VGA DB-15)		
Internal connector	Two USB 2.0 planar connectors (one used; one open for media reader)		
Rear audio ports	Line-in (stereo, 3.5mm), line-out (stereo, 3.5mm), microphone (stereo, 3.5mm)		
Audio	High Definition (HD) Audio, Realtek [®] ALC662 codec		
Speaker	One internal speaker for business audio		
Ethernet	Gigabit ethernet on planar, Marvell [®] 88E8056, PCIe x1, Wake on LAN [®]		
Intel AMT	None		
Modem	None		
Security chip	None		
Keyboard	Preferred Pro USB Keyboard (USB connector), 104-key, black, Lenovo logo		
Mouse	Optical Wheel Mouse (USB connector), 400 dpi, black, Lenovo logo		
Power supply	220 watts with variable speed fan, manual switch		
Preloaded operating system²⁰	- Microsoft® Windows® Vista Business Edition (32-bit)		Supports ThinkVantage® technologies
Preloaded applications⁵	<ul style="list-style-type: none"> • Rescue and Recovery™ • Client Security Solution™ • ThinkVantage Productivity Center • ThinkVantage System Update • System Migration Assistant • Norton Internet Security™ (90 days of virus definitions) • Diskeeper® Home • PC-Doctor™ (diagnostics) • Adobe® Reader • Windows Live™ Toolbar • Windows Live Search • Picasa from Google • Microsoft Office 2007 Trial (60-day) • Sonic RecordNow and Drive Letter Access (DVD±RW) • Corel® WinDVD® (DVD, DVD±RW) 		RoHS-compliant
Accessories	1GB PC2-5300 CL5 NP DDR2 UDIMM 73P4984 2GB PC2-5300 CL5 NP DDR2 UDIMM 73P4985 1GB PC2-6400 NP DDR2 UDIMM 41U2977 2GB PC2-6400 NP DDR2 UDIMM 41U2978 250GB SATA 3.0Gb/s Disk (7200 rpm) 41N3015 500GB SATA 3.0Gb/s Disk (7200 rpm) 43R1990 USB Portable Diskette Drive 05K9276 USB 2.0 Lenovo Multimedia Headset 40Y8518 USB 2.0 Lenovo Webcam 40Y8519 USB 2.0 Essential Memory Key 32GB 45K1258 USB 2.0 Security Memory Key 2GB 41U5119 USB 2.0 Security Memory Key 4GB 41U5120 USB 2.0 Ultra Secure Memory Key 2GB 45J5916 USB 2.0 Ultra Secure Memory Key 4GB 45J5917 USB 2.0 Ultra Secure Memory Key 8GB 45J5918 USB 2.0 Portable 160GB Hard Disk 43R1784 USB 2.0 Portable Secure 320GB Hard Disk 43R2019 ThinkVision® L1700p 17" Monitor 9417HE2 ThinkVision L1940p Wide 19" Monitor 4424HB6 ThinkVision L2240p Wide 22" Monitor 4422HB6 ThinkVision L2440p Wide 24" Monitor 4420HB2 Wireless Kbd & Opt Wheel Mouse (via USB) 73P4067 Laser Tilt Wheel Mouse (USB, PS/2) 41U3074 Kensington Cable Lock from Lenovo 73P2582 ADD2 DVI-I PCIe Connection Adapter 73P2516 ADD2 DVI-D Monitor Connection (HDCP) 43R1985 ATI™ Radeon™ HD 2400 Pro 128MB 43R1961 ATI Radeon HD 2400 XT 256MB 43R1962 NVIDIA® Quadro® 256MB NVS 290 43R1765 Acc Guide in pdf lenovo.com/accessoriesguide Other accessories at lenovo.com/accessories		Limited Warranty¹ <ul style="list-style-type: none"> ⇒ 3-year parts and labor ⇒ International Warranty Service⁹ ⇒ Customer Replaceable Unit (CRU) parts only (with limited onsite service for selected parts³, 8 am - 5 pm, Mon - Fri coverage excluding holidays, next business day response time) ⇒ Onsite service upgrade options (in eligible locations):⁷ <ul style="list-style-type: none"> • 3-year LOR 9x5, 4 hour response (ThinkPlus™ part number 41C9192) • 3-year LOR 24x7, 4 hour response (ThinkPlus part number 41C9193) • 4-year LOR 9x5, Next Business Day (ThinkPlus part number 41C9194) • 4-year LOR 9x5, 4 hour response (ThinkPlus part number 41C9195) • 4-year LOR 24x7, 4 hour response (ThinkPlus part number 41C9196) ⇒ ThinkPlus services at lenovo.com/thinkplus/warranty ⇒ Post warranty maintenance services available ⇒ 24 hour x 7 day¹⁴ toll-free support during the warranty period¹ via 800-426-7378

See footnotes for important warranty information
US models announced October 21, 2008

Name	Type-model	Slot x bay	Processor	GHz	L2 cache	Core	Memory ⁸	SATA disk	SATA optical	Graphics	ENERGY STAR 4.0	Preload	Vista logo	Global Educ	Avail date
☞	M57e	9438-AJU	4x3 Pentium E2180	2.00	1MB	Dual	1GB	160GB ²	DVD±RW	GMA	ES40	XP Pro	No	Sep 08	
☞	M57e	9438-AKU	4x3 Pentium E2200	2.20	1MB	Dual	2GB	160GB	DVD±RW	GMA	ES40	XP Pro	No	Sep 08	
☞	M57e	9438-ALU	4x3 Core 2 Duo E7200	2.53	3MB	Dual	1GB	160GB	DVD±RW	GMA	ES40	XP Pro	No	Sep 08	
☞	M57e	9438-AMU	4x3 Core 2 Duo E7200	2.53	3MB	Dual	2GB	160GB	DVD	GMA+ADD2	ES40	XP Pro	No	Sep 08	
☞	M57e	9438-B1U	4x3 Core 2 Duo E7200	2.53	3MB	Dual	1GB	160GB	DVD±RW	GMA	ES40	Bus32	Basic	No	Jun 08
☞	M57e	9438-ANU	4x3 Core 2 Duo E7300	2.66	3MB	Dual	1GB	160GB	DVD±RW	GMA	ES40	Bus32	Prem	No	Sep 08

• These models have a 3-year limited warranty¹

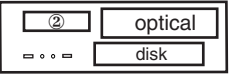
Positioning Processor	<p>Mainstream enterprise stability and manageability Intel® Pentium® Dual-Core Processor E2180 or E2200 with dual-core, Intel 64 Technology, Execute Disable Bit, EIST, 800MHz system bus, and 1MB L2 cache or Intel Core™ 2 Duo Processor E7200 or E7300 with dual-core, Intel 64 Technology, Execute Disable Bit, EIST, and 1066MHz system bus with 3MB L2 cache Processor in FC-LGA6 or FC-LGA8 package in LGA775 socket</p>		<p>Desktop</p>  <ul style="list-style-type: none"> • Business black color • 13.0" W X 16.2" D X 4.1" H • 331mm W X 412mm D X 104mm H • 19.4 lb (8.8 kg) in max configuration • Toolless cover removal • Toolless disk, diskette drive, optical drive removal • Toolless adapter retention <p>Bay ① 5.25", 1.6" high, access, std optical Bay ② 3.5", 1" high, access, open (reader/diskette) Bay ③ 3.5", 1" high, no access, std disk</p> <p>Slot 1: Low Profile, PCI Express x16 (35w max)[*] Slot 2: Low Profile, PCI Express x1 Slot 3: Low Profile, 32-bit PCI 2.3 Slot 4: Low Profile, 32-bit PCI 2.3</p> <p>[*] used in some models</p>
Implementation	Processor in FC-LGA6 or FC-LGA8 package in LGA775 socket		
Memory	<p>1GB or 2GB std, 4GB max⁸, PC2-5300 667MHz DDR2, non-parity, dual-channel capable, two 240-pin DIMM sockets; Non-italics: standard memory in one socket; one socket available</p>		
Graphics	<p>All: Intel Graphics Media Accelerator 3100 (GMA 3100), integrated graphics in G31, uses main memory (up to 256MB), one analog VGA DB-15 connector Some: ADD2 DVI-D Monitor Connection (HDCP), PCI Express[®] adapter in PCIe x16 slot, provides DVI-D connector to support second monitor, HDCP-compliant</p>		
SATA disk	160GB, SATA 3.0Gb/s 7200 rpm, vibration dampening mounts		
SATA controller	Serial ATA, SATA 3.0Gb/s, integrated in ICH7		
SATA DVD	Some: DVD-ROM DL SATA 1.5Gb/s 16X-48X Max ⁴ Drive (41N5618)		
SATA DVD±RW	Some: Super Multi-Burner DL DVD±RW SATA 1.5Gb/s Drive (41N5620)		
SATA cables	Two SATA cables (each 1-drop to device), four SATA connectors on planar		
eSATA port	None		
EIDE controller	Enhanced IDE, ATA-100, integrated in ICH7, one EIDE connector on planar		
Diskette drive	None		
Media reader	None		
Chipset	<p>Intel G31 Express Chipset; I/O Controller Hub 7 (ICH7) for SATA 3.0Gb/s, ATA-100 EIDE, PCI Express x1, PCI 2.3, USB, LPC bus / ITE Tech[®] IT8718 Super I/O for serial, parallel, keyboard, mouse functions</p>		
Front ports	Two USB 2.0, microphone (stereo, 3.5mm), headphone (stereo, 3.5mm)		
Rear ports	Four USB 2.0, serial (9-pin), parallel (25-pin), keyboard (PS/2), mouse (PS/2), ethernet (RJ-45), monitor (VGA DB-15, DVI-D in some models)		
Internal connector	Two USB 2.0 planar connectors (one used; one open for media reader)		
Rear audio ports	Line-in (stereo, 3.5mm), line-out (stereo, 3.5mm), microphone (stereo, 3.5mm)		
Audio	High Definition (HD) Audio, Realtek [®] ALC662 codec		
Speaker	One internal speaker for business audio		
Ethernet	Gigabit ethernet on planar, Marvell [®] 88E8056, PCIe x1, Wake on LAN [®]		
Intel AMT	None		
Modem	None		
Security chip	None		
Keyboard	Preferred Pro USB Keyboard (USB connector), 104-key, black, Lenovo logo		
Mouse	Optical Wheel Mouse (USB connector), 400 dpi, black, Lenovo logo		
Power supply	220 watts with variable speed fan, autosensing, 80% PSU		
Preloaded operating system²⁰	<p>- Some: Microsoft[®] Windows[®] XP Professional with Vista[®] COA - Some: Microsoft Windows Vista Business Edition (32-bit)</p>		
Preloaded applications⁵ (all OSes)	<ul style="list-style-type: none"> • Rescue and Recovery[™] • Client Security Solution[™] • ThinkVantage Productivity Center • ThinkVantage System Update • System Migration Assistant • Norton Internet Security[™] • Diskeeper[®] Home • PC-Doctor[™] (diagnostics) • Adobe[®] Reader • Windows Live[™] Toolbar • Windows Live Search • Picasa from Google • Microsoft Office 2007 Trial (60-day) • Multimedia Center for Think Offerings (DVD, DVD±RW) (XP) • Sonic RecordNow and Drive Letter Access (DVD±RW) • Corel[®] WinDVD[®] (DVD, DVD±RW) • Corel WinDVD Creator (DVD±RW) (XP) 		
Accessories	<ul style="list-style-type: none"> 1GB PC2-5300 CL5 NP DDR2 UDIMM 73P4984 2GB PC2-5300 CL5 NP DDR2 UDIMM 73P4985 1GB PC2-6400 NP DDR2 UDIMM 41U2977 2GB PC2-6400 NP DDR2 UDIMM 41U2978 250GB SATA 3.0Gb/s Disk (7200 rpm) 41N3015 500GB SATA 3.0Gb/s Disk (7200 rpm) 43R1990 USB Portable Diskette Drive 05K9276 USB 2.0 Lenovo Multimedia Headset 40Y8518 USB 2.0 Lenovo Webcam 40Y8519 USB 2.0 Essential Memory Key 32GB 45K1258 USB 2.0 Ultra Secure Memory Key 8GB 45J5918 USB 2.0 Portable Secure 320GB Hard Disk 43R2019 ThinkVision[®] L2240p Wide 22" Monitor 4422HB6 ThinkVision L2440p Wide 24" Monitor 4420HB2 Wireless Kbd & Opt Wheel Mouse (via USB) 73P4067 Laser Tilt Wheel Mouse (USB, PS/2) 41U3074 Kensington Cable Lock from Lenovo 73P2582 ADD2 DVI-I PCIe Connection Adapter 73P2516 ADD2 DVI-D Monitor Connection (HDCP) 43R1985 ATI[™] Radeon[™] HD 2400 Pro 128MB 43R1961 ATI Radeon HD 2400 XT 256MB 43R1962 NVIDIA[®] Quadro[®] 256MB NVS 290 43R1765 Acc Guide in pdf lenovo.com/accessoriesguide Other accessories at lenovo.com/accessories 		
	<p>☞ 3-year parts and labor</p> <p>☞ International Warranty Service⁹</p> <p>☞ Customer Replaceable Unit (CRU) parts only (with limited onsite service for selected parts³, 8 am - 5 pm, Mon - Fri coverage excluding holidays, next business day response time)</p> <p>☞ Onsite service upgrade options (in eligible locations):⁷</p> <ul style="list-style-type: none"> • 3-year LOR 9x5, 4 hour response (ThinkPlus[™] part number 41C9192) • 3-year LOR 24x7, 4 hour response (ThinkPlus part number 41C9193) • 4-year LOR 9x5, Next Business Day (ThinkPlus part number 41C9194) • 4-year LOR 9x5, 4 hour response (ThinkPlus part number 41C9195) • 4-year LOR 24x7, 4 hour response (ThinkPlus part number 41C9196) <p>☞ ThinkPlus services at lenovo.com/thinkplus/warranty</p> <p>☞ Post warranty maintenance services available</p> <p>☞ 24 hour x 7 day¹⁴ toll-free support during the warranty period¹ via 800-426-7378</p>		
	<p>Supports ThinkVantage[®] technologies</p> <p>EPEAT[™] Gold rating ENERGY STAR 4.0-compliant RoHS-compliant</p>		

See footnotes for important warranty information

☞ US models announced August 19, 2008; previous model on June 24, 2008

ThinkCentre® M57e Desktop (6177) - ENERGY STAR® 4.0 (GMP)

Personal Systems Reference (PSREF)

Name	Type-model	Slot x bay	Processor	GHz	L2 cache	Core	Memory ⁶	SATA disk	SATA optical	Graphics	ENERGY STAR 4.0	Vista preload	Limited warranty ¹	Global (G) GMP (P)	Avail date
M57e	6177-B1U	4x3	Core 2 Duo E8400	3.00	6MB	Dual	1GB	160GB ²	DVD±RW	GMA	ES40	Business32	3-yr	G P	Jul 08

• **This model is part of the Global Models Plus (GMP) program with limited onsite service³ 3-year limited warranty**

Positioning Processor	<i>Mainstream enterprise stability and manageability</i> Intel® Core™ 2 Duo Processor E8400 with dual-core, Intel 64 Technology, Virtualization Technology, Execute Disable Bit, EIST, TXT, and 1333MHz system bus with 6MB L2 cache Processor in FC-LGA8 package in LGA775 socket										Desktop				
Implementation															
Memory	1GB std, 4GB max⁸, PC2-5300 667MHz DDR2 , non-parity, dual-channel capable, two 240-pin DIMM sockets; <i>Non-italics</i> : standard memory in one socket; one socket available										<ul style="list-style-type: none"> • Business black color • 13.0" W X 16.2" D X 4.1" H • 331mm W X 412mm D X 104mm H • 19.4 lb (8.8 kg) in max configuration • Toolless cover removal • Toolless disk, diskette drive, optical drive removal • Toolless adapter retention 				
Graphics	Intel Graphics Media Accelerator 3100 (GMA 3100) , integrated graphics in G31, uses main memory (up to 256MB), one analog VGA DB-15 connector, supports dual independent display with optional ADD2 adapter										Bay ① 5.25", 1.6" high, access, std optical Bay ② 3.5", 1" high, access, open (reader/diskette) Bay ③ 3.5", 1" high, no access, std disk				
SATA disk	160GB , SATA 3.0Gb/s 7200 rpm, vibration dampening mounts										Slot 1: Low Profile, PCI Express x16 (35w max)				
SATA controller	Serial ATA, SATA 3.0Gb/s, integrated in ICH7										Slot 2: Low Profile, PCI Express x1				
SATA DVD±RW	Super Multi-Burner DL DVD±RW SATA 1.5Gb/s Drive (41N5620)										Slot 3: Low Profile, 32-bit PCI 2.3				
SATA cables	Two SATA cables (each 1-drop to device), four SATA connectors										Slot 4: Low Profile, 32-bit PCI 2.3				
eSATA port	None														
EIDE controller	Enhanced IDE, ATA-100, integrated in ICH7, one EIDE connector on planar														
Diskette drive	None														
Media reader	None														
Chipset	Intel G31 Express Chipset ; I/O Controller Hub 7 (ICH7) for SATA 3.0Gb/s, ATA-100 EIDE, PCI Express [®] x1, PCI 2.3, USB, LPC bus / ITE Tech [®] IT8718 Super I/O for serial, parallel, keyboard, mouse functions										Security <ul style="list-style-type: none"> • One lock to secure both cover and entire system to fixed object: <ul style="list-style-type: none"> - Padlock loop (in rear for opt padlock) - Security slot (in rear for optional Kensington[®] Microsaver[®] cable) • Power-on password • Administrator password • Hard disk password • Boot sequence control • Boot without keyboard, mouse, diskette • Serial port I/O control • Parallel port I/O control • USB port disablement 				
Front ports	Two USB 2.0, microphone (stereo, 3.5mm), headphone (stereo, 3.5mm)														
Rear ports	Four USB 2.0, serial (9-pin), parallel (25-pin), keyboard (PS/2), mouse (PS/2), ethernet (RJ-45), monitor (VGA DB-15)														
Internal connector	Two USB 2.0 planar connectors (one used; one open for media reader)														
Rear audio ports	Line-in (stereo, 3.5mm), line-out (stereo, 3.5mm), microphone (stereo, 3.5mm)														
Audio	High Definition (HD) Audio, Realtek [®] ALC662 codec														
Speaker	One internal speaker for business audio														
Ethernet	Gigabit ethernet on planar, Marvell [®] 88E8056, PCIe x1, Wake on LAN [®]														
Intel AMT	None														
Modem	None														
Security chip	None														
Keyboard	Preferred Pro USB Keyboard (USB connector), 104-key, black, Lenovo logo														
Mouse	Optical Wheel Mouse (USB connector), 400 dpi, black, Lenovo logo														
Power supply	220 watts with variable speed fan, autosensing, 80% PSU														
Preloaded operating system²⁰	Accessories										Supports ThinkVantage [®] technologies				
- Microsoft [®] Windows [®] Vista [®] Business Edition (32-bit)	1GB PC2-5300 CL5 NP DDR2 UDIMM										73P4984				
↕ Vista Basic logo	2GB PC2-5300 CL5 NP DDR2 UDIMM										73P4985				
Preloaded applications⁵	1GB PC2-6400 NP DDR2 UDIMM										41U2977				
• Rescue and Recovery [™]	2GB PC2-6400 NP DDR2 UDIMM										41U2978				
• Client Security Solution [™]	250GB SATA 3.0Gb/s Disk (7200 rpm)										41N3015				
• ThinkVantage Productivity Center	500GB SATA 3.0Gb/s Disk (7200 rpm)										43R1990				
• ThinkVantage System Update	USB Portable Diskette Drive										05K9276				
• System Migration Assistant	USB 2.0 Lenovo Multimedia Headset										40Y8518				
• Norton Internet Security [™] (90 days of virus definitions)	USB 2.0 Lenovo Webcam										40Y8519				
• Diskeeper [®] Home	USB 2.0 Essential Memory Key 32GB										45K1258				
• PC-Doctor [™] (diagnostics)	USB 2.0 Ultra Secure Memory Key 2GB										45J5916				
• Adobe [®] Reader	USB 2.0 Ultra Secure Memory Key 4GB										45J5917				
• Windows Live [™] Toolbar	USB 2.0 Ultra Secure Memory Key 8GB										45J5918				
• Windows Live Search	USB 2.0 Portable 160GB Hard Disk										43R1784				
• Picasa from Google	USB 2.0 Portable Secure 320GB Hard Disk										43R2019				
• Microsoft Office 2007 Trial (60-day)	ThinkVision [®] L1700p 17" Monitor										9417HE2				
• Sonic RecordNow and Drive Letter Access (DVD±RW)	ThinkVision L1940p Wide 19" Monitor										4424HB6				
• Corel [®] WinDVD [®] (DVD±RW)	ThinkVision L2240p Wide 22" Monitor										4422HB6				
	ThinkVision L2440p Wide 24" Monitor										4420HB2				
	Wireless Kbd & Opt Wheel Mouse (via USB)										73P4067				
	Laser Tilt Wheel Mouse (USB, PS/2)										41U3074				
	Kensington Cable Lock from Lenovo										73P2582				
	ADD2 DVI-I PCIe Connection Adapter										73P2516				
	ADD2 DVI-D Monitor Connection (HDCP)										43R1985				
	ATI [™] Radeon [™] HD 2400 Pro 128MB										43R1961				
	ATI Radeon HD 2400 XT 256MB										43R1962				
	NVIDIA [®] Quadro [®] 256MB NVS 290										43R1765				
	Acc Guide in pdf lenovo.com/accessoriesguide														
	Other accessories at lenovo.com/accessories														
											EPEAT [™] Gold rating				
											ENERGY STAR 4.0-compliant				
											RoHS-compliant				
											Limited Warranty¹ <ul style="list-style-type: none"> ↔ 3-year parts and labor ↔ International Warranty Service⁹ ↔ Customer Replaceable Unit (CRU) parts only (with limited onsite service for selected parts³, 8 am - 5 pm, Mon - Fri coverage excluding holidays, next business day response time) ↔ Onsite service upgrade options (in eligible locations):⁷ <ul style="list-style-type: none"> • 4-year LOR 9x5, Next Business Day (ThinkPlus part number 41C9194) • 4-year LOR 9x5, 4 hour response (ThinkPlus part number 41C9195) • 4-year LOR 24x7, 4 hour response (ThinkPlus part number 41C9196) ↔ ThinkPlus services at lenovo.com/thinkplus/warranty ↔ Post warranty maintenance services available ↔ 24 hour x 7 day¹⁴ toll-free support during the warranty period¹ via 800-426-7378 				

See footnotes for important warranty information
US model announced June 24, 2008

© Lenovo
(MONA2-7) June 2008

ThinkCentre® M57e Desktop (7065) - GMP

Personal Systems Reference (PSREF)

Name	Type-model	Slot x bay	Processor	GHz	L2 cache	Core	Memory ^a	SATA disk	SATA optical	Graphics	Vista preload	Limited warranty ¹	Global (G) GMP (P)	Avail date
M57e	7065-AAU	4x3	Pentium E2200	2.20	1MB	Dual	1GB	160GB ²	Combo	GMA	Business32	3-yr	G P	Apr 08
M57e	7065-ABU	4x3	Core 2 Duo E4600	2.40	2MB	Dual	1GB	160GB	Combo	GMA	Business32	3-yr	G P	Apr 08
M57e	7065-ACU	4x3	Core 2 Duo E8200	2.66	6MB	Dual	1GB	160GB	Combo	GMA	Business32	3-yr	G P	Apr 08

- **These models are part of the Global Models Plus (GMP) program with limited onsite service³ 3-year limited warranty**

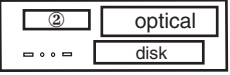
Positioning Processor	Mainstream enterprise stability and manageability Intel® Pentium® Dual-Core Processor E2200 with dual-core, Intel 64 Technology, Execute Disable Bit, EIST, 800MHz system bus, and 1MB shared L2 cache or Intel Core™ 2 Duo Processor E4600 with dual-core, Intel 64 Technology, Execute Disable Bit, EIST, 800MHz system bus, and 2MB shared L2 cache or Intel Core 2 Duo Processor E8200 with dual-core, Intel 64 Technology, Virtualization Technology, Execute Disable Bit, EIST, TXT, and 1333MHz system bus with 6MB shared L2 cache Processor in FC-LGA6 or FC-LGA8 package in LGA775 socket		Desktop  <ul style="list-style-type: none"> • Business black color • 13.0" W X 16.2" D X 4.1" H • 331mm W X 412mm D X 104mm H • 19.4 lb (8.8 kg) in max configuration • Toolless cover removal • Toolless disk, diskette drive, optical drive removal • Toolless adapter retention 																																																																								
Implementation	1GB std, 4GB max⁸, PC2-5300 667MHz DDR2 , non-parity, dual-channel capable, two 240-pin DIMM sockets; <i>Non-italics</i> : standard memory in one socket; one socket available		Bay ① 5.25", 1.6" high, access, std optical Bay ② 3.5", 1" high, access, open (reader/diskette) Bay ③ 3.5", 1" high, no access, std disk Slot 1: Low Profile, PCI Express x16 (35w max) Slot 2: Low Profile, PCI Express x1 Slot 3: Low Profile, 32-bit PCI 2.3 Slot 4: Low Profile, 32-bit PCI 2.3																																																																								
Memory																																																																											
Graphics	Intel Graphics Media Accelerator 3100 (GMA 3100) , integrated graphics in G31, uses main memory (up to 256MB), one analog VGA DB-15 connector, supports dual independent display with optional ADD2 adapter																																																																										
SATA disk	160GB , SATA 3.0Gb/s 7200 rpm, vibration dampening mounts SATA controller Serial ATA, SATA 3.0Gb/s, integrated in ICH7 SATA Combo CD-RW/DVD-ROM Combo SATA 1.5Gb/s Drive SATA cables Two SATA cables (each 1-drop to device), four SATA connectors on planar eSATA port None EIDE controller Enhanced IDE, ATA-100, integrated in ICH7, one EIDE connector on planar Diskette drive None Media reader None		Security <ul style="list-style-type: none"> • One lock to secure both cover and entire system to fixed object: <ul style="list-style-type: none"> - Padlock loop (in rear for opt padlock) - Security slot (in rear for optional Kensington® Microsaver® cable) • Power-on password • Administrator password • Hard disk password • Boot sequence control • Boot without keyboard, mouse, diskette • Serial port I/O control • Parallel port I/O control • USB port disablement 																																																																								
Chipset	Intel G31 Express Chipset ; I/O Controller Hub 7 (ICH7) for SATA 3.0Gb/s, ATA-100 EIDE, PCI Express® x1, PCI 2.3, USB, LPC bus / ITE Tech® IT8718 Super I/O for serial, parallel, keyboard, mouse functions																																																																										
Front ports	Two USB 2.0, microphone (stereo, 3.5mm), headphone (stereo, 3.5mm)																																																																										
Rear ports	Four USB 2.0, serial (9-pin), parallel (25-pin), keyboard (PS/2), mouse (PS/2), ethernet (RJ-45), monitor (VGA DB-15)																																																																										
Internal connector	Two USB 2.0 planar connectors (one used; one open for media reader)																																																																										
Rear audio ports	Line-in (stereo, 3.5mm), line-out (stereo, 3.5mm), microphone (stereo, 3.5mm)																																																																										
Audio	High Definition (HD) Audio, Realtek® ALC662 codec																																																																										
Speaker	One internal speaker for business audio																																																																										
Ethernet	Gigabit ethernet on planar, Marvell® 88E8056, PCIe x1, Wake on LAN®																																																																										
Intel AMT	None																																																																										
Modem	None																																																																										
Security chip	None																																																																										
Keyboard	Preferred Pro USB Keyboard (USB connector), 104-key, black, Lenovo logo																																																																										
Mouse	Optical Wheel Mouse (USB connector), 400 dpi, black, Lenovo logo																																																																										
Power supply	220 watts with variable speed fan, manual switch		Supports ThinkVantage® technologies																																																																								
Preloaded operating system²⁰	Accessories <table border="0"> <tr> <td>- Microsoft® Windows® Vista® Business Edition (32-bit)</td> <td>1GB PC2-5300 CL5 NP DDR2 UDIMM</td> <td>73P4984</td> </tr> <tr> <td>↕ Vista Basic logo</td> <td>2GB PC2-5300 CL5 NP DDR2 UDIMM</td> <td>73P4985</td> </tr> <tr> <td></td> <td>1GB PC2-6400 NP DDR2 UDIMM</td> <td>41U2977</td> </tr> <tr> <td></td> <td>2GB PC2-6400 NP DDR2 UDIMM</td> <td>41U2978</td> </tr> <tr> <td></td> <td>250GB SATA 3.0Gb/s Disk (7200 rpm)</td> <td>41N3015</td> </tr> <tr> <td></td> <td>500GB SATA 3.0Gb/s Disk (7200 rpm)</td> <td>43R1990</td> </tr> <tr> <td></td> <td>USB 2.0 Lenovo Multimedia Headset</td> <td>40Y8518</td> </tr> <tr> <td></td> <td>USB 2.0 Lenovo Webcam</td> <td>40Y8519</td> </tr> <tr> <td></td> <td>USB 2.0 Essential Memory Key 32GB</td> <td>45K1258</td> </tr> <tr> <td></td> <td>USB 2.0 Ultra Secure Memory Key 8GB</td> <td>45J5918</td> </tr> <tr> <td></td> <td>USB 2.0 Portable Secure 320GB Hard Disk</td> <td>43R2019</td> </tr> <tr> <td></td> <td>Super Multi-Burner DL DVD±RW SATA Drive</td> <td>41N5620</td> </tr> <tr> <td></td> <td>ThinkVision® L2240p Wide 22" Monitor</td> <td>4422HB6</td> </tr> <tr> <td></td> <td>ThinkVision L2440p Wide 24" Monitor</td> <td>4420HB2</td> </tr> <tr> <td></td> <td>Wireless Kbd & Opt Wheel Mouse (via USB)</td> <td>73P4067</td> </tr> <tr> <td></td> <td>Laser Tilt Wheel Mouse (USB, PS/2)</td> <td>41U3074</td> </tr> <tr> <td></td> <td>Kensington Cable Lock from Lenovo</td> <td>73P2582</td> </tr> <tr> <td></td> <td>ADD2 DVI-I PCIe Connection Adapter</td> <td>73P2516</td> </tr> <tr> <td></td> <td>ADD2 DVI-D Monitor Connection (HDCP)</td> <td>43R1985</td> </tr> <tr> <td></td> <td>ATI™ Radeon™ HD 2400 Pro 128MB</td> <td>43R1961</td> </tr> <tr> <td></td> <td>ATI Radeon HD 2400 XT 256MB</td> <td>43R1962</td> </tr> <tr> <td></td> <td>NVIDIA® Quadro® 256MB NVS 290</td> <td>43R1765</td> </tr> <tr> <td></td> <td>Acc Guide in pdf lenovo.com/accessoriesguide</td> <td></td> </tr> <tr> <td></td> <td>Other accessories at lenovo.com/accessories</td> <td></td> </tr> </table>		- Microsoft® Windows® Vista® Business Edition (32-bit)	1GB PC2-5300 CL5 NP DDR2 UDIMM	73P4984	↕ Vista Basic logo	2GB PC2-5300 CL5 NP DDR2 UDIMM	73P4985		1GB PC2-6400 NP DDR2 UDIMM	41U2977		2GB PC2-6400 NP DDR2 UDIMM	41U2978		250GB SATA 3.0Gb/s Disk (7200 rpm)	41N3015		500GB SATA 3.0Gb/s Disk (7200 rpm)	43R1990		USB 2.0 Lenovo Multimedia Headset	40Y8518		USB 2.0 Lenovo Webcam	40Y8519		USB 2.0 Essential Memory Key 32GB	45K1258		USB 2.0 Ultra Secure Memory Key 8GB	45J5918		USB 2.0 Portable Secure 320GB Hard Disk	43R2019		Super Multi-Burner DL DVD±RW SATA Drive	41N5620		ThinkVision® L2240p Wide 22" Monitor	4422HB6		ThinkVision L2440p Wide 24" Monitor	4420HB2		Wireless Kbd & Opt Wheel Mouse (via USB)	73P4067		Laser Tilt Wheel Mouse (USB, PS/2)	41U3074		Kensington Cable Lock from Lenovo	73P2582		ADD2 DVI-I PCIe Connection Adapter	73P2516		ADD2 DVI-D Monitor Connection (HDCP)	43R1985		ATI™ Radeon™ HD 2400 Pro 128MB	43R1961		ATI Radeon HD 2400 XT 256MB	43R1962		NVIDIA® Quadro® 256MB NVS 290	43R1765		Acc Guide in pdf lenovo.com/accessoriesguide			Other accessories at lenovo.com/accessories		RoHS-compliant
- Microsoft® Windows® Vista® Business Edition (32-bit)	1GB PC2-5300 CL5 NP DDR2 UDIMM	73P4984																																																																									
↕ Vista Basic logo	2GB PC2-5300 CL5 NP DDR2 UDIMM	73P4985																																																																									
	1GB PC2-6400 NP DDR2 UDIMM	41U2977																																																																									
	2GB PC2-6400 NP DDR2 UDIMM	41U2978																																																																									
	250GB SATA 3.0Gb/s Disk (7200 rpm)	41N3015																																																																									
	500GB SATA 3.0Gb/s Disk (7200 rpm)	43R1990																																																																									
	USB 2.0 Lenovo Multimedia Headset	40Y8518																																																																									
	USB 2.0 Lenovo Webcam	40Y8519																																																																									
	USB 2.0 Essential Memory Key 32GB	45K1258																																																																									
	USB 2.0 Ultra Secure Memory Key 8GB	45J5918																																																																									
	USB 2.0 Portable Secure 320GB Hard Disk	43R2019																																																																									
	Super Multi-Burner DL DVD±RW SATA Drive	41N5620																																																																									
	ThinkVision® L2240p Wide 22" Monitor	4422HB6																																																																									
	ThinkVision L2440p Wide 24" Monitor	4420HB2																																																																									
	Wireless Kbd & Opt Wheel Mouse (via USB)	73P4067																																																																									
	Laser Tilt Wheel Mouse (USB, PS/2)	41U3074																																																																									
	Kensington Cable Lock from Lenovo	73P2582																																																																									
	ADD2 DVI-I PCIe Connection Adapter	73P2516																																																																									
	ADD2 DVI-D Monitor Connection (HDCP)	43R1985																																																																									
	ATI™ Radeon™ HD 2400 Pro 128MB	43R1961																																																																									
	ATI Radeon HD 2400 XT 256MB	43R1962																																																																									
	NVIDIA® Quadro® 256MB NVS 290	43R1765																																																																									
	Acc Guide in pdf lenovo.com/accessoriesguide																																																																										
	Other accessories at lenovo.com/accessories																																																																										
Preloaded applications⁵	<ul style="list-style-type: none"> • Rescue and Recovery™ • Client Security Solution™ • ThinkVantage Productivity Center • ThinkVantage System Update • System Migration Assistant • Norton Internet Security™ (90 days of virus definitions) • Diskeeper® Home • PC-Doctor™ (diagnostics) • Adobe® Reader • Windows Live™ Toolbar • Windows Live Search • Picasa from Google • Microsoft Office 2007 Trial (60-day) • Sonic RecordNow and Drive Letter Access (combo) • Corel® WinDVD® (combo) 		Limited Warranty¹ <ul style="list-style-type: none"> ↔ 3-year parts and labor ↔ International Warranty Service⁹ ↔ Customer Replaceable Unit (CRU) parts only (with limited onsite service for selected parts³, 8 am - 5 pm, Mon - Fri coverage excluding holidays, next business day response time) ↔ Onsite service upgrade options (in eligible locations):⁷ <ul style="list-style-type: none"> • 4-year LOR 9x5, Next Business Day (ThinkPlus part number 41C9194) • 4-year LOR 9x5, 4 hour response (ThinkPlus part number 41C9195) • 4-year LOR 24x7, 4 hour response (ThinkPlus part number 41C9196) ↔ ThinkPlus services at lenovo.com/thinkplus/warranty ↔ Post warranty maintenance services available ↔ 24 hour x 7 day¹⁴ toll-free support during the warranty period¹ via 800-426-7378 																																																																								

See footnotes for important warranty information
 US models announced March 18, 2008

Name	Type-model	Slot x bay	Processor	GHz	L2 cache	Core	Memory ⁸	SATA disk	2nd Disk Bay	SATA optical	Graphics	Preload	Vista logo	Global Educ	Avail date
M57e	6179-B2U	4x4	Pentium E2200	2.20	1MB	Dual	1GB	160GB ²	None	DVD	GMA	XP Pro	None	None	Jun 08
M57e	6179-B1U	4x4	Pentium E2200	2.20	1MB	Dual	2GB	160GB	None	DVD±RW	GMA	XP Pro	None	None	Jun 08
M57e	6179-B3U	4x4	Core 2 Duo E7200	2.53	3MB	Dual	1GB	160GB	None	DVD	GMA	XP Pro	None	None	Jun 08
M57e	6179-B4U	4x4	Core 2 Duo E7200	2.53	3MB	Dual	2GB	160GB	None	DVD±RW	GMA	XP Pro	None	None	Jun 08
ES	M57e	6179-B5U	Pentium E2200	2.20	1MB	Dual	1GB	160GB	None	DVD	GMA	Business32	Prem	None	Aug 08
ES	M57e	6179-B6U	Pentium E2200	2.20	1MB	Dual	2GB	160GB	None	DVD±RW	GMA	Business32	Prem	None	Aug 08

• These small and medium business (SMB) models are part of the US TopSeller™ Program
• These models have a 3-year limited warranty¹

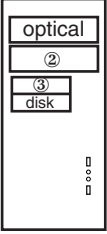
Positioning Processor	<p><i>Stability and manageability for small and medium businesses</i></p> <p>Intel® Pentium® Dual-Core Processor E2200 with dual-core, Intel 64 Technology, Execute Disable Bit, EIST, 800MHz system bus, and 1MB L2 cache or Intel Core™ 2 Duo Processor E7200 with dual-core, Intel 64 Technology, Execute Disable Bit, EIST, and 1066MHz system bus with 3MB L2 cache</p>	<p>Tower</p> <ul style="list-style-type: none"> • Business black color; metal case • 6.9" W X 17.3" D X 15.8" H • 175mm W X 440mm D X 402mm H • 24.2 lb (11.0 kg) in max configuration • Handle on top front • Toolless cover removal • Toolless disk, diskette drive, optical drive removal • Toolless adapter retention 	
Implementation	Processor in FC-LGA6 or FC-LGA8 package in LGA775 socket	<p>Bay ① 5.25", 1.6" high, access, std optical</p> <p>Bay ② 5.25", 1.6" high, access, open</p> <p>Bay ③ 3.5", 1" high, access, open (reader/diskette)</p> <p>Bay ④ 3.5", 1" high, no access, std disk</p>	
Memory	<p>1GB or 2GB std, 4GB max⁸, PC2-5300 667MHz DDR2, non-parity, dual-channel capable, two 240-pin DIMM sockets;</p> <p><i>Italics:</i> standard memory in both sockets; no sockets avail;</p> <p><i>Non-italics:</i> standard memory in one socket; one socket available</p>	<p>Slot 1: half-length, full-height, PCI Express x16 (75w max)</p> <p>Slot 2: half-length, full-height, PCI Express x1</p> <p>Slot 3: half-length, full-height, 32-bit PCI 2.3</p> <p>Slot 4: half-length, full-height, 32-bit PCI 2.3</p>	
Graphics	<p>Intel Graphics Media Accelerator 3100 (GMA 3100), integrated graphics in G31, uses main memory (up to 256MB), one analog VGA DB-15 connector, supports dual independent display with optional ADD2 adapter</p>	<p>Security</p> <ul style="list-style-type: none"> • One lock to secure both cover and entire system to fixed object: <ul style="list-style-type: none"> - Padlock loop (in rear for opt padlock) - Security slot (in rear for optional Kensington® Microsaver® cable) • Power-on password • Administrator password • Hard disk password • Boot sequence control • Boot without keyboard, mouse, diskette • Serial port I/O control • Parallel port I/O control • USB port disablement 	
SATA disk	<p>160GB, SATA 3.0Gb/s 7200 rpm, vibration dampening mounts</p>	<p>Supports ThinkVantage® technologies</p> <p>RoHS-compliant</p> <p>Limited Warranty¹</p> <ul style="list-style-type: none"> ↪ 3-year parts and labor ↪ International Warranty Service⁹ ↪ Customer Replaceable Unit (CRU) parts only (with limited onsite service for selected parts³, 8 am - 5 pm, Mon - Fri coverage excluding holidays, next business day response time) ↪ Onsite service upgrade options (in eligible locations):⁷ <ul style="list-style-type: none"> • 3-year LOR 9x5, 4 hour response (ThinkPlus™ part number 41C9192) • 3-year LOR 24x7, 4 hour response (ThinkPlus part number 41C9193) • 4-year LOR 9x5, Next Business Day (ThinkPlus part number 41C9194) • 4-year LOR 9x5, 4 hour response (ThinkPlus part number 41C9195) • 4-year LOR 24x7, 4 hour response (ThinkPlus part number 41C9196) ↪ ThinkPlus services at lenovo.com/thinkplus/warranty ↪ Post warranty maintenance services available ↪ 24 hour x 7 day¹⁴ toll-free support during the warranty period¹ via 800-426-7378 	
SATA controller	Serial ATA, SATA 3.0Gb/s, integrated in ICH7		
SATA DVD	<i>Some:</i> DVD-ROM DL SATA 1.5Gb/s 16-48X Max ⁴ Drive (41N5618)		
SATA DVD±RW	<i>Some:</i> Super Multi-Burner DL DVD±RW SATA 1.5Gb/s Drive (41N5620)		
SATA cables	Two SATA cables (each 1-drop to device), four SATA connectors on planar		
eSATA port	None		
EIDE controller	Enhanced IDE, ATA-100, integrated in ICH7, one EIDE connector on planar		
Diskette drive	None		
Media reader	None		
Chipset	<p>Intel G31 Express Chipset; I/O Controller Hub 7 (ICH7) for SATA 3.0Gb/s, ATA-100 EIDE, PCI Express[®] x1, PCI 2.3, USB, LPC bus /</p> <p>ITE Tech[®] IT8718 Super I/O for serial, parallel, keyboard, mouse functions</p>		
Front ports	Two USB 2.0, microphone (stereo, 3.5mm), headphone (stereo, 3.5mm)		
Rear ports	Four USB 2.0, serial (9-pin), parallel (25-pin), keyboard (PS/2), mouse (PS/2), ethernet (RJ-45), monitor (VGA DB-15)		
Internal connector	Two USB 2.0 planar connectors (one used; one open for media reader)		
Rear audio ports	Line-in (stereo, 3.5mm), line-out (stereo, 3.5mm), microphone (stereo, 3.5mm)		
Audio	High Definition (HD) Audio, Realtek [®] ALC662 codec		
Speaker	One internal speaker for business audio		
Ethernet	Gigabit ethernet on planar, Marvell [®] 88E8056, PCIe x1, Wake on LAN [®]		
Intel AMT	None		
Modem	None		
Security chip	None		
Keyboard	Preferred Pro USB Keyboard (USB connector), 104-key, black, Lenovo logo		
Mouse	Optical Wheel Mouse (USB connector), 400 dpi, black, Lenovo logo		
Power supply	280 watts with variable speed fan, manual switch		
Preloaded operating system²⁰	<p>- <i>Some:</i> Microsoft Windows[®] XP Professional with Vista[®] COA</p> <p>- <i>Some:</i> Microsoft Windows Vista Business Edition (32-bit)</p>		
Preloaded applications⁵ (all OSes)	<ul style="list-style-type: none"> • Rescue and Recovery™ • Client Security Solution™ • ThinkVantage Productivity Center • ThinkVantage System Update • System Migration Assistant • Norton Internet Security™ • Diskeeper[®] Home • PC-Doctor™ (diagnostics) • Adobe[®] Reader • Windows Live™ Toolbar • Windows Live Search • Picasa from Google • Microsoft Office 2007 Trial (60-day) • Multimedia Center for Think Offerings (DVD, DVD±RW) (XP) • Sonic RecordNow and Drive Letter Access (DVD±RW) • Corel[®] WinDVD[®] (DVD, DVD±RW) • Corel WinDVD Creator (DVD±RW) (XP) 		
Accessories	<ul style="list-style-type: none"> 1GB PC2-5300 CL5 NP DDR2 UDIMM 73P4984 2GB PC2-5300 CL5 NP DDR2 UDIMM 73P4985 1GB PC2-6400 NP DDR2 UDIMM 41U2977 2GB PC2-6400 NP DDR2 UDIMM 41U2978 250GB SATA 3.0Gb/s Disk (7200 rpm) 41N3015 500GB SATA 3.0Gb/s Disk (7200 rpm) 43R1990 USB 2.0 Lenovo Multimedia Headset 40Y8518 USB 2.0 Lenovo Webcam 40Y8519 USB 2.0 Essential Memory Key 32GB 45K1258 USB 2.0 Ultra Secure Memory Key 8GB 45J5918 USB 2.0 Portable Secure 320GB Hard Disk 43R2019 ThinkVision[®] L2440p Wide 24" Monitor 4420HB2 Wireless Kbd & Opt Wheel Mouse (via USB) 73P4067 Laser Tilt Wheel Mouse (USB, PS/2) 41U3074 Kensington Cable Lock from Lenovo 73P2582 ADD2 DVI-I PCIe Connection Adapter 73P2516 ADD2 DVI-D Monitor Connection (HDCP) 43R1985 ATI™ Radeon™ HD 2400 XP 128MB 43R1961 ATI Radeon HD 2400 XT 256MB 43R1962 ATI Radeon HD 2600 XT 512MB 43R1963 NVIDIA[®] Quadro[®] 256MB NVS 290 43R1765 NVIDIA Quadro 256MB FX 370 43R1766 NVIDIA Quadro 512MB FX 1700 43R1767 Acc Guide in pdf lenovo.com/accessoriesguide Other accessories at lenovo.com/accessories 		

See footnotes for important warranty information

ES US models announced August 19, 2008; previous models on June 24, 2008

Name	Type-model	Slot x bay	Processor	GHz	L2 cache	Cores	Memory ⁸	SATA disk	2nd Disk Bay	SATA optical	Graphics	Preload	Vista logo	Global Educ	Avail date
M57e	6179-BBU	4x4	Pentium E5200	2.50	2MB	2	1GB	160GB ²	None	DVD	GMA	XP Pro	Premium	None	Nov 08
M57e	6179-BCU	4x4	Pentium E5200	2.50	2MB	2	2GB	160GB	None	DVD±RW	GMA	XP Pro	Premium	None	Nov 08
M57e	6179-BFU	4x4	Core 2 Duo E7300	2.66	3MB	2	1GB	160GB	None	DVD	GMA	XP Pro	Premium	None	Nov 08
M57e	6179-BDU	4x4	Core 2 Duo E7300	2.66	3MB	2	2GB	160GB	None	DVD±RW	GMA	XP Pro	Premium	None	Nov 08

- These small and medium business (SMB) models are part of the US TopSeller™ Program
- These models have a 3-year limited warranty¹

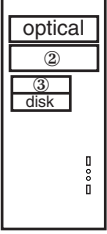
Positioning Processor	Stability and manageability for small and medium businesses Intel® Pentium® Dual-Core Processor E5200 with dual-core, 800MHz system bus, and 2MB L2 cache or Intel Core™ 2 Duo Processor E7300 with dual-core, 1066MHz system bus, and 3MB L2 cache Processor in FC-LGA6 or FC-LGA8 package in LGA775 socket	Tower <ul style="list-style-type: none"> • Business black color; metal case • 6.9" W X 17.3" D X 15.8" H • 175mm W X 440mm D X 402mm H • 24.2 lb (11.0 kg) in max configuration • Handle on top front • Toolless cover removal • Toolless disk, diskette drive, optical drive removal • Toolless adapter retention 
Implementation	Processor in FC-LGA6 or FC-LGA8 package in LGA775 socket	<ul style="list-style-type: none"> Bay ① 5.25", 1.6" high, access, std optical Bay ② 5.25", 1.6" high, access, open Bay ③ 3.5", 1" high, access, open (reader/diskette) Bay ④ 3.5", 1" high, no access, std disk
Memory	1GB or 2GB std , 4GB max ⁸ , PC2-5300 667MHz DDR2 , non-parity, dual-channel capable, two 240-pin DIMM sockets; <i>Non-italics:</i> standard memory in one socket; one socket available	
Graphics	Intel Graphics Media Accelerator 3100 (GMA 3100) , integrated graphics in G31, uses main memory (up to 256MB), one analog VGA DB-15 connector, supports dual independent display with optional ADD2 adapter	Slot 1: half-length, full-height, PCI Express x16 (75w max) Slot 2: half-length, full-height, PCI Express x1 Slot 3: half-length, full-height, 32-bit PCI 2.3 Slot 4: half-length, full-height, 32-bit PCI 2.3
SATA disk	160GB , SATA 3.0Gb/s 7200 rpm, vibration dampening mounts	<p>Security</p> <ul style="list-style-type: none"> • One lock to secure both cover and entire system to fixed object: <ul style="list-style-type: none"> - Padlock loop (in rear for opt padlock) - Security slot (in rear for optional Kensington® Microsaver® cable) • Power-on password • Administrator password • Hard disk password • Boot sequence control • Boot without keyboard, mouse, diskette • Serial port I/O control • Parallel port I/O control • USB port disablement
SATA controller	Serial ATA, SATA 3.0Gb/s, integrated in ICH7	
SATA DVD	<i>Some:</i> DVD-ROM DL SATA 1.5Gb/s 16-48X Max ⁴ Drive (41N5618)	
SATA DVD±RW	<i>Some:</i> Super Multi-Burner DL DVD±RW SATA Drive (41N5620)	
SATA cables	Two SATA cables (each 1-drop to device), four SATA connectors	
eSATA port	None	
EIDE controller	Enhanced IDE, ATA-100, integrated in ICH7, one EIDE connector on planar	
Diskette drive	None	
Media reader	None	
Chipset	Intel G31 Express Chipset ; I/O Controller Hub 7 (ICH7) for SATA 3.0Gb/s, ATA-100 EIDE, PCI Express [®] x1, PCI 2.3, USB, LPC bus / ITE Tech [®] IT8718 Super I/O for serial, parallel, keyboard, mouse functions	
Front ports	Two USB 2.0, microphone (stereo, 3.5mm), headphone (stereo, 3.5mm)	
Rear ports	Four USB 2.0, serial (9-pin), parallel (25-pin), keyboard (PS/2), mouse (PS/2), ethernet (RJ-45), monitor (VGA DB-15)	
Internal connector	Two USB 2.0 planar connectors (one used; one open for media reader)	
Rear audio ports	Line-in (stereo, 3.5mm), line-out (stereo, 3.5mm), microphone (stereo, 3.5mm)	
Audio	High Definition (HD) Audio, Realtek [®] ALC662 codec	
Speaker	One internal speaker for business audio	
Ethernet	Gigabit ethernet on planar, Marvel [®] 88E8056, PCIe x1, Wake on LAN [®]	
Intel AMT	None	
Modem	None	
Security chip	None	
Keyboard	Preferred Pro USB Keyboard (USB connector), 104-key, black, Lenovo logo	Supports ThinkVantage [®] technologies
Mouse	Optical Wheel Mouse (USB connector), 400 dpi, black, Lenovo logo	RoHS-compliant
Power supply	280 watts with variable speed fan, manual switch	
Preloaded operating system²⁰	Accessories	<p>Limited Warranty¹</p> <ul style="list-style-type: none"> ↔ 3-year parts and labor ↔ International Warranty Service⁹ ↔ Customer Replaceable Unit (CRU) parts only (with limited onsite service for selected parts³, 8 am - 5 pm, Mon - Fri coverage excluding holidays, next business day response time) ↔ Onsite service upgrade options (in eligible locations):⁷ <ul style="list-style-type: none"> • 3-year LOR 9x5, 4 hour response (ThinkPlus™ part number 41C9192) • 3-year LOR 24x7, 4 hour response (ThinkPlus part number 41C9193) • 4-year LOR 9x5, Next Business Day (ThinkPlus part number 41C9194) • 4-year LOR 9x5, 4 hour response (ThinkPlus part number 41C9195) • 4-year LOR 24x7, 4 hour response (ThinkPlus part number 41C9196) ↔ ThinkPlus services at lenovo.com/thinkplus/warranty ↔ Post warranty maintenance services available ↔ 24 hour x 7 day¹⁴ toll-free support during the warranty period¹ via 800-426-7378
- Microsoft [®] Windows [®] XP Professional with Vista [®] COA	1GB PC2-5300 CL5 NP DDR2 UDIMM 73P4984	
↔ Disk-to-Disk Recovery (in hidden protected area)	2GB PC2-5300 CL5 NP DDR2 UDIMM 73P4985	
Preloaded applications⁵	1GB PC2-6400 NP DDR2 UDIMM 41U2977	
• Rescue and Recovery™	2GB PC2-6400 NP DDR2 UDIMM 41U2978	
• Client Security Solution™	250GB SATA 3.0Gb/s Disk (7200 rpm) 41N3015	
• ThinkVantage Productivity Center	500GB SATA 3.0Gb/s Disk (7200 rpm) 43R1990	
• ThinkVantage System Update	USB 2.0 Lenovo Multimedia Headset 40Y8518	
• System Migration Assistant	USB 2.0 Lenovo Webcam 40Y8519	
• Norton Internet Security™ (90 days of virus definitions)	USB 2.0 Essential Memory Key 32GB 45K1258	
• Diskeeper [®] Home	USB 2.0 Ultra Secure Memory Key 8GB 45J5918	
• PC-Doctor™ (diagnostics)	USB 2.0 Portable Secure 320GB Hard Disk 43R2019	
• Adobe [®] Reader	ThinkVision™ L2240p Wide 22" Monitor 4422HB6	
• Windows Live™ Toolbar	ThinkVision L2440p Wide 24" Monitor 4420HB2	
• Windows Live Search	Wireless Kbd & Opt Wheel Mouse (via USB) 73P4067	
• Picasa from Google	Laser Tilt Wheel Mouse (USB, PS/2) 41U3074	
• Microsoft Office 2007 Trial (60-day)	Kensington Cable Lock from Lenovo 73P2582	
• Multimedia Center for Think Offerings (DVD, DVD±RW)	ADD2 DVI-I PCIe Connection Adapter 73P2516	
• Sonic RecordNow and Drive Letter Access (DVD±RW)	ADD2 DVI-D Monitor Connection (HDCP) 43R1985	
• Corel [®] WinDVD [®] (DVD, DVD±RW)	ATI™ Radeon™ HD 2400 Pro 128MB 43R1961	
• Corel WinDVD Creator (DVD±RW)	ATI Radeon HD 2400 XT 256MB 43R1962	
	ATI Radeon HD 2600 XT 512MB 43R1963	
	NVIDIA [®] Quadro [®] 256MB NVS 290 43R1765	
	NVIDIA Quadro 256MB FX 370 43R1766	
	NVIDIA Quadro 512MB FX 1700 43R1767	
	Acc Guide in pdf lenovo.com/accessoriesguide	
	Other accessories at lenovo.com/accessories	

See footnotes for important warranty information
US models announced October 21, 2008

Name	Type-model	Slot x bay	Processor	GHz	L2 cache	Core	Memory ⁶	SATA disk	2nd Disk Bay	SATA optical	Graphics	Preload	Limited warranty ¹	Global Educ	Avail date
M57e	9439-B8U	4x5	Pentium E2160	1.80	1MB	Dual	1GB	160GB ²	Bay	Combo	GMA	XP Pro	3-yr	None	Mar 08
M57e	9439-B9U	4x5	Core 2 Duo E4500	2.20	2MB	Dual	1GB	160GB	Bay	Combo	GMA	XP Pro	3-yr	None	Mar 08
M57e	9439-BAU	4x5	Core 2 Duo E6550	2.33	4MB	Dual	1GB	160GB	Bay	Combo	GMA	XP Pro	3-yr	None	Mar 08
M57e	9439-A2U	4x5	Core 2 Duo E8200	2.66	6MB	Dual	1GB	160GB	Bay	Combo	GMA	XP Pro	3-yr	None	Mar 08

Positioning Processor	<p><i>Mainstream enterprise stability and manageability</i></p> <p>Intel® Pentium® Dual-Core Processor E2160 with dual-core, Intel 64 Technology, Execute Disable Bit, EIST, 800MHz system bus, and 1MB shared L2 cache or Intel Core™ 2 Duo Processor E4500 with dual-core, Intel 64 Technology, Execute Disable Bit, EIST, 800MHz system bus, and 2MB shared L2 cache or Intel Core 2 Duo Processor E6550 with dual-core, Intel 64 Technology, Virtualization Technology, Execute Disable Bit, EIST, TXT, and 1333MHz system bus, and 4MB shared L2 cache or Intel Core 2 Duo Processor E8200 with dual-core, Intel 64 Technology, Virtualization Technology, Execute Disable Bit, EIST, TXT, and 1333MHz system bus with 6MB shared L2 cache Processor in FC-LGA6 or FC-LGA8 package in LGA775 socket</p>		<p>Tower</p> <ul style="list-style-type: none"> Business black color; metal case 6.9" W X 17.3" D X 15.8" H 175mm W X 440mm D X 402mm H 24.2 lb (11.0 kg) in max configuration Handle on top front Toolless cover removal Toolless disk, diskette drive, optical drive removal Toolless adapter retention 	
Implementation			<p>Bay ① 5.25", 1.6" high, access, std optical</p> <p>Bay ② 5.25", 1.6" high, access, open</p> <p>Bay ③ 3.5", 1" high, access, open (reader/diskette)</p> <p>Bay ④ 3.5", 1" high, no access, std disk</p> <p>Bay ⑤ 3.5", 1" high, no access, opt disk</p>	
Memory	<p>1GB std, 4GB max⁶, PC2-5300 667MHz DDR2, non-parity, dual-channel capable, two 240-pin DIMM sockets; <i>Non-italics</i>: standard memory in one socket; one socket available</p>		<p>Slot 1: half-length, full-height, PCI Express x16 (75w max)</p> <p>Slot 2: half-length, full-height, PCI Express x1</p> <p>Slot 3: half-length, full-height, 32-bit PCI 2.3</p> <p>Slot 4: half-length, full-height, 32-bit PCI 2.3</p>	
Graphics	<p>Intel Graphics Media Accelerator 3100 (GMA 3100), integrated graphics in G31, uses main memory (up to 256MB), one analog VGA DB-15 connector, supports dual independent display with optional ADD2 adapter</p>		<p>Security</p> <ul style="list-style-type: none"> One lock to secure both cover and entire system to fixed object: <ul style="list-style-type: none"> Padlock loop (in rear for opt padlock) Security slot (in rear for optional Kensington® Microsaver® cable) Power-on password Administrator password Hard disk password Boot sequence control Boot without keyboard, mouse, diskette Serial port I/O control Parallel port I/O control USB port disablement 	
SATA disk	<p>160GB, SATA 3.0Gb/s 7200 rpm, vibration dampening mounts</p>		<p>Supports ThinkVantage® technologies</p> <p>RoHS-compliant</p> <p>Limited Warranty¹</p> <ul style="list-style-type: none"> 3-year parts and labor International Warranty Service⁹ Customer Replaceable Unit (CRU) parts only (with limited onsite service for selected parts³, 8 am - 5 pm, Mon - Fri coverage excluding holidays, next business day response time) Onsite service upgrade options (in eligible locations):⁷ <ul style="list-style-type: none"> 3-year LOR 9x5, 4 hour response (ThinkPlus™ part number 41C9192) 3-year LOR 24x7, 4 hour response (ThinkPlus part number 41C9193) 4-year LOR 9x5, Next Business Day (ThinkPlus part number 41C9194) 4-year LOR 9x5, 4 hour response (ThinkPlus part number 41C9195) 4-year LOR 24x7, 4 hour response (ThinkPlus part number 41C9196) ThinkPlus services at lenovo.com/thinkplus/warranty Post warranty maintenance services available 24 hour x 7 day¹⁴ toll-free support during the warranty period¹ via 800-426-7378 	
SATA controller	<p>Serial ATA, SATA 3.0Gb/s, integrated in ICH7</p>			
SATA Combo	<p>CD-RW/DVD-ROM Combo SATA 1.5Gb/s Drive</p>			
SATA cables	<p>Two SATA cables (each 1-drop to device), four SATA connectors on planar</p>			
eSATA port	<p>None</p>			
EIDE controller	<p>Enhanced IDE, ATA-100, integrated in ICH7, one EIDE connector on planar</p>			
Diskette drive	<p>None</p>			
Media reader	<p>None</p>			
Chipset	<p>Intel G31 Express Chipset; I/O Controller Hub 7 (ICH7) for SATA 3.0Gb/s, ATA-100 EIDE, PCI Express® x1, PCI 2.3, USB, LPC bus / ITE Tech® IT8718 Super I/O for serial, parallel, keyboard, mouse functions</p>			
Front ports	<p>Two USB 2.0, microphone (stereo, 3.5mm), headphone (stereo, 3.5mm)</p>			
Rear ports	<p>Four USB 2.0, serial (9-pin), parallel (25-pin), keyboard (PS/2), mouse (PS/2), ethernet (RJ-45), monitor (VGA DB-15)</p>			
Internal connector	<p>Two USB 2.0 planar connectors (one used; one open for media reader)</p>			
Rear audio ports	<p>Line-in (stereo, 3.5mm), line-out (stereo, 3.5mm), microphone (stereo, 3.5mm)</p>			
Audio	<p>High Definition (HD) Audio, Realtek® ALC662 codec</p>			
Speaker	<p>One internal speaker for business audio</p>			
Ethernet	<p>Gigabit ethernet on planar, Marvell® 88E8056, PCIe x1, Wake on LAN®</p>			
Intel AMT	<p>None</p>			
Modem	<p>None</p>			
Security chip	<p>None</p>			
Keyboard	<p>Preferred Pro USB Keyboard (USB connector), 104-key, black, Lenovo logo</p>			
Mouse	<p>Optical Wheel Mouse (USB connector), 400 dpi, black, Lenovo logo</p>			
Power supply	<p>280 watts with variable speed fan, manual switch</p>			
Preloaded operating system ²⁰	<p>- Microsoft® Windows® XP Professional with Vista® COA</p> <p>↕ Disk-to-Disk Recovery (in hidden protected area)</p>			
Preloaded applications ⁵	<ul style="list-style-type: none"> Rescue and Recovery™ Client Security Solution™ ThinkVantage Productivity Center ThinkVantage System Update System Migration Assistant Norton Internet Security™ Diskeeper® Home PC-Doctor™ (diagnostics) Adobe® Reader Windows Live™ Toolbar Windows Live Search Picasa from Google Microsoft Office 2007 Trial (60-day) Multimedia Center for Think Offerings (combo) Sonic RecordNow and Drive Letter Access (combo) Corel® WinDVD® (combo) 			
Accessories	<ul style="list-style-type: none"> 1GB PC2-5300 CL5 NP DDR2 UDIMM 73P4984 2GB PC2-5300 CL5 NP DDR2 UDIMM 73P4985 1GB PC2-6400 NP DDR2 UDIMM 41U2977 2GB PC2-6400 NP DDR2 UDIMM 41U2978 500GB SATA 3.0Gb/s Disk (7200 rpm) 43R1990 USB 2.0 Lenovo Multimedia Headset 40Y8518 USB 2.0 Essential Memory Key 32GB 45K1258 USB 2.0 Ultra Secure Memory Key 8GB 45J5918 USB 2.0 Portable Secure 320GB Hard Disk 43R2019 Super Multi-Burner DL DVD±RW SATA Drive 41N5620 ThinkVision® L2240p Wide 22" Monitor 4422HB6 ThinkVision L2440p Wide 24" Monitor 4420HB2 Wireless Kbd & Opt Wheel Mouse (via USB) 73P4067 Kensington Cable Lock from Lenovo 73P2582 ADD2 DVI-I PCIe Connection Adapter 73P2516 ADD2 DVI-D Monitor Connection (HDCP) 43R1985 ATI™ Radeon™ HD 2400 Pro 128MB 43R1961 ATI Radeon HD 2400 XT 256MB 43R1962 ATI Radeon HD 2600 XT 512MB 43R1963 NVIDIA® Quadro® 256MB NVS 290 43R1765 NVIDIA Quadro 256MB FX 370 43R1766 NVIDIA Quadro 512MB FX 1700 43R1767 Acc Guide in pdf lenovo.com/accessoriesguide Other accessories at lenovo.com/accessories 			

See footnotes for important warranty information

US model announced March 18, 2008; previous models on February 26, 2008

US model withdrawn effective September 2008

Name	Type-model	Slot x bay	Processor	GHz	L2 cache	Core	Memory ⁸	SATA disk	2nd Disk Bay	SATA optical	Graphics	Preload	Global Educ	Avail date
M57e	9439-EBU	4x5	Pentium E2180	2.00	1MB	Dual	1GB	160GB ²	Bay	DVD	GMA+ADD2	XP Pro	None	Aug 08
M57e	9439-E5U	4x5	Pentium E2200	2.20	1MB	Dual	1GB	160GB	Bay	DVD	GMA	XP Pro	None	Aug 08
M57e	9439-E6U	4x5	Pentium E2200	2.20	1MB	Dual	2GB	160GB	Bay	DVD±RW	GMA	XP Pro	None	Aug 08
M57e	9439-E7U	4x5	Core 2 Duo E7200	2.53	3MB	Dual	1GB	160GB	Bay	DVD±RW	GMA	XP Pro	None	Aug 08
M57e	9439-E9U	4x5	Core 2 Duo E7200	2.53	3MB	Dual	2GB	160GB	Bay	DVD	GMA+ADD2	XP Pro	None	Aug 08
M57e	9439-E8U	4x5	Core 2 Duo E7300	2.66	3MB	Dual	2GB	160GB	Bay	DVD±RW	GMA	XP Pro	None	Aug 08

• **These models have a 3-year limited warranty¹**

Positioning Processor	<p><i>Mainstream enterprise stability and manageability</i> Intel® Pentium® Dual-Core Processor E2180 or E2200 with dual-core, Intel 64 Technology, Execute Disable Bit, EIST, 800MHz system bus, and 1MB L2 cache or Intel Core™ 2 Duo Processor E7200 or E7300 with dual-core, Intel 64 Technology, Execute Disable Bit, EIST, and 1066MHz system bus with 3MB L2 cache Processor in FC-LGA6 or FC-LGA8 package in LGA775 socket</p>		<p>Tower</p> <ul style="list-style-type: none"> • Business black color; metal case • 6.9" W X 17.3" D X 15.8" H • 175mm W X 440mm D X 402mm H • 24.2 lb (11.0 kg) in max configuration • Handle on top front • Toolless cover removal • Toolless disk, diskette drive, optical drive removal • Toolless adapter retention 																																													
Implementation	<p>Processor in FC-LGA6 or FC-LGA8 package in LGA775 socket</p>		<p>Bay ① 5.25", 1.6" high, access, std optical Bay ② 5.25", 1.6" high, access, open Bay ③ 3.5", 1" high, access, open (reader/diskette) Bay ④ 3.5", 1" high, no access, std disk Bay ⑤ 3.5", 1" high, no access, opt disk</p>	<p>Slot 1: half-length, full-height, PCI Express x16 (75w max)[*] Slot 2: half-length, full-height, PCI Express x1 Slot 3: half-length, full-height, 32-bit PCI 2.3 Slot 4: half-length, full-height, 32-bit PCI 2.3</p>																																												
Memory	<p>1GB or 2GB std, 4GB max⁸, PC2-5300 667MHz DDR2, non-parity, dual-channel capable, two 240-pin DIMM sockets; <i>Non-italics</i>: standard memory in one socket; one socket available</p>		<p>* used in some models</p>																																													
Graphics	<p><i>All</i>: Intel Graphics Media Accelerator 3100 (GMA 3100), integrated graphics in G31, uses main memory (up to 256MB), one analog VGA DB-15 connector <i>Some</i>: ADD2 DVI-D Monitor Connection (HDCP), PCI Express[®] adapter in PCIe x16 slot, provides DVI-D connector to support second monitor, HDCP-compliant</p>		<p>Security</p> <ul style="list-style-type: none"> • One lock to secure both cover and entire system to fixed object: <ul style="list-style-type: none"> - Padlock loop (in rear for opt padlock) - Security slot (in rear for optional Kensington® Microsaver® cable) • Power-on password • Administrator password • Hard disk password • Boot sequence control • Boot without keyboard, mouse, diskette • Serial port I/O control • Parallel port I/O control • USB port disablement 																																													
SATA disk	<p>160GB, SATA 3.0Gb/s 7200 rpm, vibration dampening mounts</p>		<p>Security</p> <ul style="list-style-type: none"> • Supports ThinkVantage® technologies 																																													
SATA controller	<p>Serial ATA, SATA 3.0Gb/s, integrated in ICH7</p>		<p>RoHS-compliant</p>																																													
SATA DVD	<p><i>Some</i>: DVD-ROM DL SATA 1.5Gb/s 16X-48X Max⁴ (41N5618)</p>		<p>Limited Warranty¹</p> <ul style="list-style-type: none"> ↪ 3-year parts and labor ↪ International Warranty Service⁹ ↪ Customer Replaceable Unit (CRU) parts only (with limited onsite service for selected parts³, 8 am - 5 pm, Mon - Fri coverage excluding holidays, next business day response time) ↪ Onsite service upgrade options (in eligible locations):⁷ <ul style="list-style-type: none"> • 3-year LOR 9x5, 4 hour response (ThinkPlus™ part number 41C9192) • 3-year LOR 24x7, 4 hour response (ThinkPlus part number 41C9193) • 4-year LOR 9x5, Next Business Day (ThinkPlus part number 41C9194) • 4-year LOR 9x5, 4 hour response (ThinkPlus part number 41C9195) • 4-year LOR 24x7, 4 hour response (ThinkPlus part number 41C9196) ↪ ThinkPlus services at lenovo.com/thinkplus/warranty ↪ Post warranty maintenance services available ↪ 24 hour x 7 day¹⁴ toll-free support during the warranty period¹ via 800-426-7378 																																													
SATA DVD±RW	<p><i>Some</i>: Super Multi-Burner DL DVD±RW SATA 1.5Gb/s (41N5620)</p>		<p>Keyboard Preferred Pro USB Keyboard (USB connector), 104-key, black, Lenovo logo</p>																																													
SATA cables	<p>Two SATA cables (each 1-drop to device), four SATA connectors</p>		<p>Mouse Optical Wheel Mouse (USB connector), 400 dpi, black, Lenovo logo</p>																																													
eSATA port	<p>None</p>		<p>Power supply 280 watts with variable speed fan, manual switch</p>																																													
EIDE controller	<p>Enhanced IDE, ATA-100, integrated in ICH7, one EIDE connector on planar</p>		<p>Preloaded operating system²⁰</p> <ul style="list-style-type: none"> - Microsoft® Windows® XP Professional with Vista® COA ↪ Disk-to-Disk Recovery (in hidden protected area) 																																													
Diskette drive	<p>None</p>		<p>Accessories</p> <table border="0"> <tr><td>1GB PC2-5300 CL5 NP DDR2 UDIMM</td><td>73P4984</td></tr> <tr><td>2GB PC2-5300 CL5 NP DDR2 UDIMM</td><td>73P4985</td></tr> <tr><td>1GB PC2-6400 NP DDR2 UDIMM</td><td>41U2977</td></tr> <tr><td>2GB PC2-6400 NP DDR2 UDIMM</td><td>41U2978</td></tr> <tr><td>500GB SATA 3.0Gb/s Disk (7200 rpm)</td><td>43R1990</td></tr> <tr><td>USB 2.0 Lenovo Multimedia Headset</td><td>40Y8518</td></tr> <tr><td>USB 2.0 Essential Memory Key 32GB</td><td>45K1258</td></tr> <tr><td>USB 2.0 Ultra Secure Memory Key 8GB</td><td>45J5918</td></tr> <tr><td>USB 2.0 Portable Secure 320GB Hard Disk</td><td>43R2019</td></tr> <tr><td>ThinkVision® L2240p Wide 22" Monitor</td><td>4422HB6</td></tr> <tr><td>ThinkVision L2440p Wide 24" Monitor</td><td>4420HB2</td></tr> <tr><td>Wireless Kbd & Opt Wheel Mouse (via USB)</td><td>73P4067</td></tr> <tr><td>Laser Tilt Wheel Mouse (USB, PS/2)</td><td>41U3074</td></tr> <tr><td>Kensington Cable Lock from Lenovo</td><td>73P2582</td></tr> <tr><td>ADD2 DVI-I PCIe Connection Adapter</td><td>73P2516</td></tr> <tr><td>ADD2 DVI-D Monitor Connection (HDCP)</td><td>43R1985</td></tr> <tr><td>ATI™ Radeon™ HD 2400 Pro 128MB</td><td>43R1961</td></tr> <tr><td>ATI Radeon HD 2400 XT 256MB</td><td>43R1962</td></tr> <tr><td>ATI Radeon HD 2600 XT 512MB</td><td>43R1963</td></tr> <tr><td>NVIDIA® Quadro® 256MB NVS 290</td><td>43R1765</td></tr> <tr><td>NVIDIA Quadro 256MB FX 370</td><td>43R1766</td></tr> <tr><td>NVIDIA Quadro 512MB FX 1700</td><td>43R1767</td></tr> </table>		1GB PC2-5300 CL5 NP DDR2 UDIMM	73P4984	2GB PC2-5300 CL5 NP DDR2 UDIMM	73P4985	1GB PC2-6400 NP DDR2 UDIMM	41U2977	2GB PC2-6400 NP DDR2 UDIMM	41U2978	500GB SATA 3.0Gb/s Disk (7200 rpm)	43R1990	USB 2.0 Lenovo Multimedia Headset	40Y8518	USB 2.0 Essential Memory Key 32GB	45K1258	USB 2.0 Ultra Secure Memory Key 8GB	45J5918	USB 2.0 Portable Secure 320GB Hard Disk	43R2019	ThinkVision® L2240p Wide 22" Monitor	4422HB6	ThinkVision L2440p Wide 24" Monitor	4420HB2	Wireless Kbd & Opt Wheel Mouse (via USB)	73P4067	Laser Tilt Wheel Mouse (USB, PS/2)	41U3074	Kensington Cable Lock from Lenovo	73P2582	ADD2 DVI-I PCIe Connection Adapter	73P2516	ADD2 DVI-D Monitor Connection (HDCP)	43R1985	ATI™ Radeon™ HD 2400 Pro 128MB	43R1961	ATI Radeon HD 2400 XT 256MB	43R1962	ATI Radeon HD 2600 XT 512MB	43R1963	NVIDIA® Quadro® 256MB NVS 290	43R1765	NVIDIA Quadro 256MB FX 370	43R1766	NVIDIA Quadro 512MB FX 1700	43R1767
1GB PC2-5300 CL5 NP DDR2 UDIMM	73P4984																																															
2GB PC2-5300 CL5 NP DDR2 UDIMM	73P4985																																															
1GB PC2-6400 NP DDR2 UDIMM	41U2977																																															
2GB PC2-6400 NP DDR2 UDIMM	41U2978																																															
500GB SATA 3.0Gb/s Disk (7200 rpm)	43R1990																																															
USB 2.0 Lenovo Multimedia Headset	40Y8518																																															
USB 2.0 Essential Memory Key 32GB	45K1258																																															
USB 2.0 Ultra Secure Memory Key 8GB	45J5918																																															
USB 2.0 Portable Secure 320GB Hard Disk	43R2019																																															
ThinkVision® L2240p Wide 22" Monitor	4422HB6																																															
ThinkVision L2440p Wide 24" Monitor	4420HB2																																															
Wireless Kbd & Opt Wheel Mouse (via USB)	73P4067																																															
Laser Tilt Wheel Mouse (USB, PS/2)	41U3074																																															
Kensington Cable Lock from Lenovo	73P2582																																															
ADD2 DVI-I PCIe Connection Adapter	73P2516																																															
ADD2 DVI-D Monitor Connection (HDCP)	43R1985																																															
ATI™ Radeon™ HD 2400 Pro 128MB	43R1961																																															
ATI Radeon HD 2400 XT 256MB	43R1962																																															
ATI Radeon HD 2600 XT 512MB	43R1963																																															
NVIDIA® Quadro® 256MB NVS 290	43R1765																																															
NVIDIA Quadro 256MB FX 370	43R1766																																															
NVIDIA Quadro 512MB FX 1700	43R1767																																															
Media reader	<p>None</p>		<p>Acc Guide in pdf lenovo.com/accessoriesguide Other accessories at lenovo.com/accessories</p>																																													
Chipset	<p>Intel G31 Express Chipset; I/O Controller Hub 7 (ICH7) for SATA 3.0Gb/s, ATA-100 EIDE, PCI Express x1, PCI 2.3, USB, LPC bus / ITE Tech® IT8718 Super I/O for serial, parallel, keyboard, mouse functions</p>		<p>Front ports Two USB 2.0, microphone (stereo, 3.5mm), headphone (stereo, 3.5mm)</p>																																													
Front ports	<p>Two USB 2.0, microphone (stereo, 3.5mm), headphone (stereo, 3.5mm)</p>		<p>Rear ports Four USB 2.0, serial (9-pin), parallel (25-pin), keyboard (PS/2), mouse (PS/2), ethernet (RJ-45), monitor (VGA DB-15, DVI-D in some models)</p>																																													
Rear ports	<p>Four USB 2.0, serial (9-pin), parallel (25-pin), keyboard (PS/2), mouse (PS/2), ethernet (RJ-45), monitor (VGA DB-15, DVI-D in some models)</p>		<p>Internal connector Two USB 2.0 planar connectors (one used; one open for media reader)</p>																																													
Internal connector	<p>Two USB 2.0 planar connectors (one used; one open for media reader)</p>		<p>Rear audio ports Line-in (stereo, 3.5mm), line-out (stereo, 3.5mm), microphone (stereo, 3.5mm)</p>																																													
Rear audio ports	<p>Line-in (stereo, 3.5mm), line-out (stereo, 3.5mm), microphone (stereo, 3.5mm)</p>		<p>Audio High Definition (HD) Audio, Realtek® ALC662 codec</p>																																													
Audio	<p>High Definition (HD) Audio, Realtek® ALC662 codec</p>		<p>Speaker One internal speaker for business audio</p>																																													
Speaker	<p>One internal speaker for business audio</p>		<p>Ethernet Gigabit ethernet on planar, Marvell® 88E8056, PCIe x1, Wake on LAN®</p>																																													
Ethernet	<p>Gigabit ethernet on planar, Marvell® 88E8056, PCIe x1, Wake on LAN®</p>		<p>Intel AMT None</p>																																													
Intel AMT	<p>None</p>		<p>Modem None</p>																																													
Modem	<p>None</p>		<p>Security chip None</p>																																													
Security chip	<p>None</p>		<p>Keyboard Preferred Pro USB Keyboard (USB connector), 104-key, black, Lenovo logo</p>																																													

See footnotes for important warranty information
 US models announced August 19, 2008

Name	Type-model	Slot x bay	Processor	GHz	L2 cache	Core	Memory ⁸	SATA disk	2nd Disk Bay	SATA optical	Graphics	Vista preload	Limited warranty ¹	Global Educ	Avail date
M57e	9439-B1U	4x5	Celeron 420	1.60	512KB	Single	1GB	160GB ²	Bay	Combo	GMA	Bus32	3-yr	None	Mar 08
M57e	9439-AAU	4x4	Celeron 430	1.80	512KB	Single	1GB	80GB		DVD	GMA	Bus32	3-yr	None	Mar 08
M57e	9439-ABU	4x4	Pentium E2160	1.80	1MB	Dual	1GB	80GB		DVD	GMA	Bus32	3-yr	None	Mar 08
M57e	9439-AQU	4x5	Pentium E2160	1.80	1MB	Dual	1GB	160GB	Bay	DVD	GMA	Bus32	3-yr	None	Mar 08
M57e	9439-APU	4x5	Pentium E2160	1.80	1MB	Dual	1GB	160GB	Bay	Combo	GMA	Bus32	3-yr	None	Mar 08
M57e	9439-ACU	4x4	Core 2 Duo E4500	2.20	2MB	Dual	1GB	80GB		DVD	GMA	Bus32	3-yr	None	Mar 08
M57e	9439-ARU	4x5	Core 2 Duo E4500	2.20	2MB	Dual	1GB	160GB	Bay	DVD	GMA	Bus32	3-yr	None	Mar 08
M57e	9439-ASU	4x5	Core 2 Duo E4500	2.20	2MB	Dual	1GB	160GB	Bay	Combo	GMA	Bus32	3-yr	None	Mar 08
M57e	9439-AUU	4x5	Core 2 Duo E6550	2.33	4MB	Dual	1GB	160GB	Bay	DVD	GMA	Bus32	3-yr	None	Mar 08
M57e	9439-ADU	4x4	Core 2 Duo E6550	2.33	4MB	Dual	1GB	160GB		Combo	GMA	Bus32	3-yr	None	Mar 08
M57e	9439-ATU	4x5	Core 2 Duo E6550	2.33	4MB	Dual	1GB	160GB	Bay	Combo	GMA	Bus32	3-yr	None	Mar 08

Positioning	<i>Mainstream enterprise stability and manageability</i>	
Processor	Intel® Celeron® Processor 420 or 430 with single-core, Intel 64 Technology, EDBit, 800MHz bus, and 512KB L2 cache or Intel Pentium® Dual-Core Processor E2160 with dual-core, Intel 64 Technology, Execute Disable Bit, EIST, 800MHz system bus, and 1MB shared L2 cache or Intel Core™ 2 Duo Processor E4500 with dual-core, Intel 64 Technology, Execute Disable Bit, EIST, 800MHz system bus, and 2MB shared L2 cache or Intel Core 2 Duo Processor E6550 with dual-core, Intel 64 Technology, Virtualization Technology, Execute Disable Bit, EIST, TXT, and 1333MHz system bus with 4MB shared L2 cache Processor in FC-LGA6 package in LGA775 socket	
Implementation	Processor in FC-LGA6 package in LGA775 socket	
Memory	1GB std, 4GB max⁸, PC2-5300 667MHz DDR2 , non-parity, dual-channel capable, two 240-pin DIMM sockets; <i>Non-italics:</i> standard memory in one socket; one socket available	
Graphics	Intel Graphics Media Accelerator 3100 (GMA 3100) , integrated graphics in G31, uses main memory (up to 256MB), one analog VGA DB-15 connector, supports dual independent display with optional ADD2 adapter	
SATA disk	80GB or 160GB , SATA 3.0Gb/s 7200 rpm, vibration dampening	
SATA controller	Serial ATA, SATA 3.0Gb/s, integrated in ICH7	
SATA DVD	<i>Some:</i> DVD-ROM DL SATA 1.5Gb/s 16-48X Max ⁴ Drive (41N5618)	
SATA Combo	<i>Some:</i> CD-RW/DVD-ROM Combo SATA 1.5Gb/s Drive	
SATA cables	Two SATA cables (each 1-drop to device), four SATA connectors on planar	
eSATA port	None	
EIDE controller	Enhanced IDE, ATA-100, integrated in ICH7, one EIDE connector on planar	
Diskette drive	None	
Media reader	None	
Chipset	Intel G31 Express Chipset ; I/O Controller Hub 7 (ICH7) for SATA 3.0Gb/s, ATA-100 EIDE, PCI Express [®] x1, PCI 2.3, USB, LPC bus / ITE Tech [®] IT8718 Super I/O for serial, parallel, keyboard, mouse functions	
Front ports	Two USB 2.0, microphone (stereo, 3.5mm), headphone (stereo, 3.5mm)	
Rear ports	Four USB 2.0, serial (9-pin), parallel (25-pin), keyboard (PS/2), mouse (PS/2), ethernet (RJ-45), monitor (VGA DB-15)	
Internal connector	Two USB 2.0 planar connectors (one used; one open for media reader)	
Rear audio ports	Line-in (stereo, 3.5mm), line-out (stereo, 3.5mm), microphone (stereo, 3.5mm)	
Audio	High Definition (HD) Audio, Realtek [®] ALC662 codec	
Speaker	One internal speaker for business audio	
Ethernet	Gigabit ethernet on planar, Marvell [®] 88E8056, PCIe x1, Wake on LAN [®]	
Intel AMT	None	
Modem	None	
Security chip	None	
Keyboard	Preferred Pro USB Keyboard (USB connector), 104-key, black, Lenovo logo	
Mouse	Optical Wheel Mouse (USB connector), 400 dpi, black, Lenovo logo	
Power supply	280 watts with variable speed fan, manual switch	

Preloaded operating system²⁰ - Microsoft® Windows® Vista Business Edition (32-bit) ⇨ Vista Basic logo	Accessories 1GB PC2-5300 CL5 NP DDR2 UDIMM 73P4984 2GB PC2-5300 CL5 NP DDR2 UDIMM 73P4985 1GB PC2-6400 NP DDR2 UDIMM 41U2977 2GB PC2-6400 NP DDR2 UDIMM 41U2978 USB 2.0 Lenovo Multimedia Headset 40Y8518 USB 2.0 Ultra Secure Memory Key 8GB 45J5918 ThinkVision® L2440p Wide 24" Monitor 4420HB2 Wireless Kbd & Opt Wheel Mouse (via USB) 73P4067 Kensington Cable Lock from Lenovo 73P2582 ADD2 DVI-I PCIe Connection Adapter 73P2516 ADD2 DVI-D Monitor Connection (HDCP) 43R1985 ATI™ Radeon™ HD 2400 Pro 128MB 43R1961 ATI Radeon HD 2400 XT 256MB 43R1962 ATI Radeon HD 2600 XT 512MB 43R1963 NVIDIA® Quadro® 256MB NVS 290 43R1765 NVIDIA Quadro 256MB FX 370 43R1766 NVIDIA Quadro 512MB FX 1700 43R1767 Other accessories at lenovo.com/accessories
---	--

Tower <ul style="list-style-type: none"> Business black color; metal case 6.9" W X 17.3" D X 15.8" H 175mm W X 440mm D X 402mm H 24.2 lb (11.0 kg) in max configuration Handle on top front Toolless cover removal Toolless disk, diskette drive, optical drive removal Toolless adapter retention 	
Bay ① 5.25", 1.6" high, access, std optical Bay ② 5.25", 1.6" high, access, open Bay ③ 3.5", 1" high, access, open (reader/diskette) Bay ④ 3.5", 1" high, no access, std disk Bay ⑤ 3.5", 1" high, no access, opt disk*	
* 2nd Disk Bay is only available on some models Slot 1: half-length, full-height, PCI Express x16 (75w max) Slot 2: half-length, full-height, PCI Express x1 Slot 3: half-length, full-height, 32-bit PCI 2.3 Slot 4: half-length, full-height, 32-bit PCI 2.3	

Security <ul style="list-style-type: none"> One lock to secure both cover and entire system to fixed object: <ul style="list-style-type: none"> - Padlock loop (in rear for opt padlock) - Security slot (in rear for optional Kensington® Microsaver® cable) Power-on password Administrator password Hard disk password Boot sequence control Boot without keyboard, mouse, diskette Serial port I/O control Parallel port I/O control USB port disablement
Supports ThinkVantage® technologies
RoHS-compliant
Limited Warranty¹ ⇨ 3-year parts and labor ⇨ International Warranty Service⁹ ⇨ Customer Replaceable Unit (CRU) parts only (with limited onsite service for selected parts³, 8 am - 5 pm, Mon - Fri coverage excluding holidays, next business day response time) ⇨ Onsite service upgrade options (in eligible locations)⁷ <ul style="list-style-type: none"> 3-year LOR 9x5, 4 hour response (ThinkPlus™ part number 41C9192) 3-year LOR 24x7, 4 hour response (ThinkPlus part number 41C9193) 4-year LOR 9x5, Next Business Day (ThinkPlus part number 41C9194) 4-year LOR 9x5, 4 hour response (ThinkPlus part number 41C9195) 4-year LOR 24x7, 4 hour response (ThinkPlus part number 41C9196) ⇨ ThinkPlus services at lenovo.com/thinkplus/warranty ⇨ 24 hour x 7 day¹⁴ toll-free support during the warranty period¹ via 800-426-7378

See footnotes for important warranty information
 US models announced February 19, 2008
 ⇨ US models withdrawn effective September 2008

Name	Type-model	Slot x bay	Processor	GHz	L2 cache	Core	Memory ⁶	SATA disk	2nd Disk Bay	SATA optical	Graphics	Vista preload	Vista logo	Global Educ	Avail date
M57e	9439-AWU	4x5	Pentium E2180	2.00	1MB	Dual	1GB	160GB ²	Bay	DVD±RW	GMA	Bus32	Basic		Aug 08
M57e	9439-DGU	4x4	Pentium E2200	2.20	1MB	Dual	1GB	160GB		Combo	GMA	Bus32	Basic	Gbl	Mar 08
M57e	9439-DHU	4x4	Core 2 Duo E4600	2.40	2MB	Dual	1GB	160GB		Combo	GMA+ADD2	Bus32	Basic	Gbl	Mar 08
M57e	9439-A3U	4x5	Core 2 Duo E8200	2.66	6MB	Dual	1GB	160GB	Bay	Combo	GMA	Bus32	Basic		Mar 08
M57e	9439-DJU	4x4	Core 2 Duo E8400	3.00	6MB	Dual	2GB	250GB		DVD±RW	GMA+ADD2	Bus32	Premium	Gbl	Mar 08

• These models have a 3-year limited warranty¹

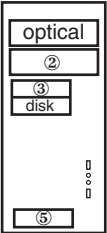
Positioning Processor	Mainstream enterprise stability and manageability Intel® Pentium® Dual-Core Processor E2180 or E2200 with dual-core, Intel 64 Technology, Execute Disable Bit, EIST, 800MHz system bus, and 1MB shared L2 cache or Intel Core™ 2 Duo Processor E4600 with dual-core, Intel 64 Technology, Execute Disable Bit, EIST, 800MHz system bus, and 2MB shared L2 cache or Intel Core 2 Duo Processor E8200 or E8400 with dual-core, Intel 64 Technology, Virtualization Technology, Execute Disable Bit, EIST, TXT, and 1333MHz system bus with 6MB shared L2 cache Processor in FC-LGA6 or FC-LGA8 package in LGA775 socket		Tower <ul style="list-style-type: none"> • Business black color; metal case • 6.9" W X 17.3" D X 15.8" H • 175mm W X 440mm D X 402mm H • 24.2 lb (11.0 kg) in max configuration • Handle on top front • Toolless cover removal • Toolless disk, diskette drive, optical drive removal • Toolless adapter retention 
Implementation			
Memory	1GB or 2GB , 4GB max ⁸ , PC2-5300 667MHz DDR2 , non-parity, dual-channel capable, two 240-pin DIMM sockets; <i>Italics:</i> standard memory in both sockets; no sockets avail; <i>Non-italics:</i> standard memory in one socket; one socket available		Bay ① 5.25", 1.6" high, access, std optical Bay ② 5.25", 1.6" high, access, open Bay ③ 3.5", 1" high, access, open (reader/diskette) Bay ④ 3.5", 1" high, no access, std disk Bay ⑤ 3.5", 1" high, no access, opt disk**
Graphics	<i>All:</i> Intel Graphics Media Accelerator 3100 (GMA 3100) , integrated graphics in G31, uses main memory (up to 256MB), one analog VGA DB-15 connector <i>Some:</i> ADD2 DVI-I PCIe Connection Adapter , PCI Express [®] adapter in PCIe x16 slot, provides DVI-I connector to support second monitor, no DVI-to-VGA dongle		** 2nd Disk Bay is only available on some models Slot 1: half-length, full-height, PCI Express x16 (75w max) [*] Slot 2: half-length, full-height, PCI Express x1 Slot 3: half-length, full-height, 32-bit PCI 2.3 Slot 4: half-length, full-height, 32-bit PCI 2.3
SATA disk	160GB or 250GB , SATA 3.0Gb/s 7200 rpm, vibration dampening		
SATA controller	Serial ATA, SATA 3.0Gb/s, integrated in ICH7		
SATA Combo	<i>Some:</i> CD-RW/DVD-ROM Combo SATA 1.5Gb/s Drive		
SATA DVD±RW	<i>Some:</i> Super Multi-Burner DL DVD±RW SATA 1.5Gb/s Drive (41N5620)		
SATA cables	Two SATA cables (each 1-drop to device), four SATA connectors on planar		
eSATA port	None		
EIDE controller	Enhanced IDE, ATA-100, integrated in ICH7, one EIDE connector on planar		
Diskette drive	None		
Media reader	None		
Chipset	Intel G31 Express Chipset ; I/O Controller Hub 7 (ICH7) for SATA 3.0Gb/s, ATA-100 EIDE, PCI Express x1, PCI 2.3, USB, LPC bus / ITE Tech® IT8718 Super I/O for serial, parallel, keyboard, mouse functions		
Front ports	Two USB 2.0, microphone (stereo, 3.5mm), headphone (stereo, 3.5mm)		
Rear ports	Four USB 2.0, serial (9-pin), parallel (25-pin), keyboard (PS/2), mouse (PS/2), ethernet (RJ-45), monitor (VGA DB-15, DVI-I in some models)		
Internal connector	Two USB 2.0 planar connectors (one used; one open for media reader)		
Rear audio ports	Line-in (stereo, 3.5mm), line-out (stereo, 3.5mm), microphone (stereo, 3.5mm)		
Audio	High Definition (HD) Audio, Realtek® ALC662 codec		
Speaker	One internal speaker for business audio		
Ethernet	Gigabit ethernet on planar, Marvell® 88E8056, PCIe x1, Wake on LAN [®]		
Intel AMT	None		
Modem	None		
Security chip	None		
Keyboard	Preferred Pro USB Keyboard (USB connector), 104-key, black, Lenovo logo		
Mouse	Optical Wheel Mouse (USB connector), 400 dpi, black, Lenovo logo		
Power supply	280 watts with variable speed fan, manual switch		
Preloaded operating system²⁰	Accessories		
- Microsoft® Windows® Vista Business Edition (32-bit)	1GB PC2-5300 CL5 NP DDR2 UDIMM	73P4984	
	2GB PC2-5300 CL5 NP DDR2 UDIMM	73P4985	
	1GB PC2-6400 NP DDR2 UDIMM	41U2977	
	2GB PC2-6400 NP DDR2 UDIMM	41U2978	
	500GB SATA 3.0Gb/s Disk (7200 rpm)	43R1990	
	USB 2.0 Lenovo Multimedia Headset	40Y8518	
	USB 2.0 Essential Memory Key 32GB	45K1258	
	USB 2.0 Ultra Secure Memory Key 8GB	45J5918	
	ThinkVision® L2440p Wide 24" Monitor	4420HB2	
	Wireless Kbd & Opt Wheel Mouse (via USB)	73P4067	
	Kensington Cable Lock from Lenovo	73P2582	
	ADD2 DVI-I PCIe Connection Adapter	73P2516	
	ADD2 DVI-D Monitor Connection (HDCP)	43R1985	
	ATI™ Radeon™ HD 2400 Pro 128MB	43R1961	
	ATI Radeon HD 2400 XT 256MB	43R1962	
	ATI Radeon HD 2600 XT 512MB	43R1963	
	NVIDIA® Quadro® 256MB NVS 290	43R1765	
	NVIDIA Quadro 256MB FX 370	43R1766	
	NVIDIA Quadro 512MB FX 1700	43R1767	
	Acc Guide in pdf lenovo.com/accessoriesguide		
	Other accessories at lenovo.com/accessories		
Preloaded applications⁵			
• Rescue and Recovery™			
• Client Security Solution™			
• ThinkVantage Productivity Center			
• ThinkVantage System Update			
• System Migration Assistant			
• Norton Internet Security™ (90 days of virus definitions)			
• Diskeeper® Home			
• PC-Doctor™ (diagnostics)			
• Adobe® Reader			
• Windows Live™ Toolbar			
• Windows Live Search			
• Picasa from Google			
• Microsoft Office 2007 Trial (60-day)			
• Sonic RecordNow and Drive Letter Access (combo, DVD±RW)			
• Corel® WinDVD® (combo, DVD±RW)			
			Security <ul style="list-style-type: none"> • One lock to secure both cover and entire system to fixed object: <ul style="list-style-type: none"> - Padlock loop (in rear for opt padlock) - Security slot (in rear for optional Kensington® Microsaver® cable) • Power-on password • Administrator password • Hard disk password • Boot sequence control • Boot without keyboard, mouse, diskette • Serial port I/O control • Parallel port I/O control • USB port disablement
			Supports ThinkVantage® technologies
			RoHS-compliant
			Limited Warranty¹ <ul style="list-style-type: none"> ↪ 3-year parts and labor ↪ International Warranty Service⁹ ↪ Customer Replaceable Unit (CRU) parts only (with limited onsite service for selected parts³, 8 am - 5 pm, Mon - Fri coverage excluding holidays, next business day response time) ↪ Onsite service upgrade options (in eligible locations):⁷ <ul style="list-style-type: none"> • 3-year LOR 9x5, 4 hour response (ThinkPlus™ part number 41C9192) • 3-year LOR 24x7, 4 hour response (ThinkPlus part number 41C9193) • 4-year LOR 9x5, Next Business Day (ThinkPlus part number 41C9194) • 4-year LOR 9x5, 4 hour response (ThinkPlus part number 41C9195) • 4-year LOR 24x7, 4 hour response (ThinkPlus part number 41C9196) ↪ ThinkPlus services at lenovo.com/thinkplus/warranty ↪ Post warranty maintenance services available ↪ 24 hour x 7 day¹⁴ toll-free support during the warranty period¹ via 800-426-7378

See footnotes for important warranty information

US model announced August 19, 2008; previous models on March 18, 2008

Name	Type-model	Slot x bay	Processor	GHz	L2 cache	Core	Memory ^a	SATA disk	2nd Disk Bay	SATA optical	Graphics	Vista preload	Limited warranty ¹	Global Educ	Avail date
M57e	9439-D6U	4x4	Core 2 Duo E7200	2.53	3MB	Dual	1GB	160GB ²	None	DVD±RW	GMA	Bus32	3-yr	None	Jun 08

• *This model has a 3-year limited warranty¹*

Positioning Processor	<i>Mainstream enterprise stability and manageability</i> Intel® Core™ 2 Duo Processor E7200 with dual-core, Intel 64 Technology, Execute Disable Bit, EIST, and 1066MHz system bus with 3MB L2 cache										Tower	
Implementation	Processor in FC-LGA8 package in LGA775 socket										<ul style="list-style-type: none"> • Business black color; metal case • 6.9" W X 17.3" D X 15.8" H • 175mm W X 440mm D X 402mm H • 24.2 lb (11.0 kg) in max configuration • Handle on top front • Toolless cover removal • Toolless disk, diskette drive, optical drive removal • Toolless adapter retention 	
Memory	1GB std , 4GB max ⁸ , PC2-5300 667MHz DDR2 , non-parity, dual-channel capable, two 240-pin DIMM sockets; <i>Non-italics</i> : standard memory in one socket; one socket available										Bay ① 5.25", 1.6" high, access, std optical Bay ② 5.25", 1.6" high, access, open Bay ③ 3.5", 1" high, access, open (reader/diskette) Bay ④ 3.5", 1" high, no access, std disk	
Graphics	Intel Graphics Media Accelerator 3100 (GMA 3100) , integrated graphics in G31, uses main memory (up to 256MB), one analog VGA DB-15 connector, supports dual independent display with optional ADD2 adapter										Slot 1: half-length, full-height, PCI Express x16 (75w max) Slot 2: half-length, full-height, PCI Express x1 Slot 3: half-length, full-height, 32-bit PCI 2.3 Slot 4: half-length, full-height, 32-bit PCI 2.3	
SATA disk	160GB , SATA 3.0Gb/s 7200 rpm, vibration dampening mounts											
SATA controller	Serial ATA, SATA 3.0Gb/s, integrated in ICH7											
SATA DVD±RW	Super Multi-Burner DL DVD±RW SATA 1.5Gb/s Drive (41N5620)											
SATA cables	Two SATA cables (each 1-drop to device), four SATA connectors											
eSATA port	None											
EIDE controller	Enhanced IDE, ATA-100, integrated in ICH7, one EIDE connector											
Diskette drive	None											
Media reader	None											
Chipset	Intel G31 Express Chipset ; I/O Controller Hub 7 (ICH7) for SATA 3.0Gb/s, ATA-100 EIDE, PCI Express [®] x1, PCI 2.3, USB, LPC bus / ITE Tech [®] IT8718 Super I/O for serial, parallel, keyboard, mouse functions											
Front ports	Two USB 2.0, microphone (stereo, 3.5mm), headphone (stereo, 3.5mm)											Security <ul style="list-style-type: none"> • One lock to secure both cover and entire system to fixed object: <ul style="list-style-type: none"> - Padlock loop (in rear for opt padlock) - Security slot (in rear for optional Kensington[®] Microsaver[®] cable) • Power-on password • Administrator password • Hard disk password • Boot sequence control • Boot without keyboard, mouse, diskette • Serial port I/O control • Parallel port I/O control • USB port disablement
Rear ports	Four USB 2.0, serial (9-pin), parallel (25-pin), keyboard (PS/2), mouse (PS/2), ethernet (RJ-45), monitor (VGA DB-15)											
Internal connector	Two USB 2.0 planar connectors (one used; one open for media reader)											
Rear audio ports	Line-in (stereo, 3.5mm), line-out (stereo, 3.5mm), microphone (stereo, 3.5mm)											
Audio	High Definition (HD) Audio, Realtek [®] ALC662 codec											
Speaker	One internal speaker for business audio											
Ethernet	Gigabit ethernet on planar, Marvell [®] 88E8056, PCIe x1, Wake on LAN [®]											
Intel AMT	None											
Modem	None											
Security chip	None											
Keyboard	Preferred Pro USB Keyboard (USB connector), 104-key, black, Lenovo logo											
Mouse	Optical Wheel Mouse (USB connector), 400 dpi, black, Lenovo logo											
Power supply	280 watts with variable speed fan, manual switch											
Preloaded operating system²⁰	- Microsoft [®] Windows [®] Vista Business Edition (32-bit) ◇ Vista Basic logo										Supports ThinkVantage [®] technologies	
Preloaded applications⁵	<ul style="list-style-type: none"> • Rescue and Recovery[™] • Client Security Solution[™] • ThinkVantage Productivity Center • ThinkVantage System Update • System Migration Assistant • Norton Internet Security[™] (90 days of virus definitions) • Diskeeper[®] Home • PC-Doctor[™] (diagnostics) • Adobe[®] Reader • Windows Live[™] Toolbar • Windows Live Search • Picasa from Google • Microsoft Office 2007 Trial (60-day) • Sonic RecordNow and Drive Letter Access (DVD±RW) • Corel[®] WinDVD[®] (DVD±RW) 										RoHS-compliant	
Accessories	1GB PC2-5300 CL5 NP DDR2 UDIMM 73P4984 2GB PC2-5300 CL5 NP DDR2 UDIMM 73P4985 1GB PC2-6400 NP DDR2 UDIMM 41U2977 2GB PC2-6400 NP DDR2 UDIMM 41U2978 250GB SATA 3.0Gb/s Disk (7200 rpm) 41N3015 500GB SATA 3.0Gb/s Disk (7200 rpm) 43R1990 USB Portable Diskette Drive 05K9276 USB 2.0 Lenovo Multimedia Headset 40Y8518 USB 2.0 Lenovo Webcam 40Y8519 USB 2.0 Essential Memory Key 32GB 45K1258 USB 2.0 Ultra Secure Memory Key 2GB 45J5916 USB 2.0 Ultra Secure Memory Key 4GB 45J5917 USB 2.0 Ultra Secure Memory Key 8GB 45J5918 USB 2.0 Portable 160GB Hard Disk 43R1784 USB 2.0 Portable Secure 320GB Hard Disk 43R2019 ThinkVision [®] L1940p Wide 19" Monitor 4424HB6 ThinkVision L2240p Wide 22" Monitor 4422HB6 ThinkVision L2440p Wide 24" Monitor 4420HB2 Wireless Kbd & Opt Wheel Mouse (via USB) 73P4067 Laser Tilt Wheel Mouse (USB, PS/2) 41U3074 Kensington Cable Lock from Lenovo 73P2582 ADD2 DVI-I PCIe Connection Adapter 73P2516 ADD2 DVI-D Monitor Connection (HDCP) 43R1985 ATI [™] Radeon [™] HD 2400 Pro 128MB 43R1961 ATI Radeon HD 2400 XT 256MB 43R1962 ATI Radeon HD 2600 XT 512MB 43R1963 NVIDIA [®] Quadro [®] 256MB NVS 290 43R1765 NVIDIA Quadro 256MB FX 370 43R1766 NVIDIA Quadro 512MB FX 1700 43R1767 Acc Guide in pdf lenovo.com/accessoriesguide Other accessories at lenovo.com/accessories										Limited Warranty ¹ <ul style="list-style-type: none"> ⇒ 3-year parts and labor ⇒ International Warranty Service⁹ ⇒ Customer Replaceable Unit (CRU) parts only (with limited onsite service for selected parts³, 8 am - 5 pm, Mon - Fri coverage excluding holidays, next business day response time) ⇒ Onsite service upgrade options (in eligible locations):⁷ <ul style="list-style-type: none"> • 3-year LOR 9x5, 4 hour response (ThinkPlus[™] part number 41C9192) • 3-year LOR 24x7, 4 hour response (ThinkPlus part number 41C9193) • 4-year LOR 9x5, Next Business Day (ThinkPlus part number 41C9194) • 4-year LOR 9x5, 4 hour response (ThinkPlus part number 41C9195) • 4-year LOR 24x7, 4 hour response (ThinkPlus part number 41C9196) ⇒ ThinkPlus services at lenovo.com/thinkplus/warranty ⇒ Post warranty maintenance services available ⇒ 24 hour x 7 day¹⁴ toll-free support during the warranty period¹ via 800-426-7378 	

See footnotes for important warranty information
US model announced June 24, 2008

Name	Type-model	Slot x bay	Processor	GHz	L2 cache	Cores	Memory ^a	SATA disk	2nd Disk Bay	SATA optical	Graphics	Vista preload	Vista logo	Global Educ	Avail date
M57e	9439-F1U	4x4	Pentium E5200	2.50	2MB	2	1GB	160GB ²	None	DVD	GMA	Bus32	Prem	None	Nov 08
M57e	9439-F2U	4x4	Pentium E5200	2.50	2MB	2	1GB	250GB	None	DVD±RW	GMA	Bus32	Prem	None	Nov 08

• *These models have a 3-year limited warranty¹*

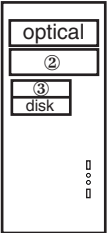
Positioning Processor	<i>Mainstream enterprise stability and manageability</i> Intel® Pentium® Dual-Core Processor E5200 with dual-core , 800MHz system bus, and 2MB L2 cache		Tower <ul style="list-style-type: none"> • Business black color; metal case • 6.9" W X 17.3" D X 15.8" H • 175mm W X 440mm D X 402mm H • 24.2 lb (11.0 kg) in max configuration • Handle on top front • Toolless cover removal • Toolless disk, diskette drive, optical drive removal • Toolless adapter retention 
Implementation	Processor in FC-LGA6 package in LGA775 socket		
Memory	1GB std , 4GB max ⁸ , PC2-5300 667MHz DDR2 , non-parity, dual-channel capable, two 240-pin DIMM sockets; <i>Non-italics</i> : standard memory in one socket; one socket available		
Graphics	Intel Graphics Media Accelerator 3100 (GMA 3100) , integrated graphics in G31, uses main memory (up to 256MB), one analog VGA DB-15 connector, supports dual independent display with optional ADD2 adapter		
SATA disk	160GB or 250GB , SATA 3.0Gb/s 7200 rpm, vibration dampening		
SATA controller	Serial ATA, SATA 3.0Gb/s, integrated in ICH7		
SATA DVD	<i>Some</i> : DVD-ROM DL SATA 1.5Gb/s 16-48X Max ⁴ Drive (41N5618)		
SATA DVD±RW	<i>Some</i> : Super Multi-Burner DL DVD±RW SATA Drive (41N5620)		
SATA cables	Two SATA cables (each 1-drop to device), four SATA connectors		
eSATA port	None		
EIDE controller	Enhanced IDE, ATA-100, integrated in ICH7, one EIDE connector		
Diskette drive	None		
Media reader	None		
Chipset	Intel G31 Express Chipset ; I/O Controller Hub 7 (ICH7) for SATA 3.0Gb/s, ATA-100 EIDE, PCI Express [®] x1, PCI 2.3, USB, LPC bus / ITE Tech [®] IT8718 Super I/O for serial, parallel, keyboard, mouse functions		
Front ports	Two USB 2.0, microphone (stereo, 3.5mm), headphone (stereo, 3.5mm)		
Rear ports	Four USB 2.0, serial (9-pin), parallel (25-pin), keyboard (PS/2), mouse (PS/2), ethernet (RJ-45), monitor (VGA DB-15)		
Internal connector	Two USB 2.0 planar connectors (one used; one open for media reader)		
Rear audio ports	Line-in (stereo, 3.5mm), line-out (stereo, 3.5mm), microphone (stereo, 3.5mm)		
Audio	High Definition (HD) Audio, Realtek [®] ALC662 codec		
Speaker	One internal speaker for business audio		
Ethernet	Gigabit ethernet on planar, Marvell [®] 88E8056, PCIe x1, Wake on LAN [®]		
Intel AMT	None		
Modem	None		
Security chip	None		
Keyboard	Preferred Pro USB Keyboard (USB connector), 104-key, black, Lenovo logo		
Mouse	Optical Wheel Mouse (USB connector), 400 dpi, black, Lenovo logo		
Power supply	280 watts with variable speed fan, manual switch		
Preloaded operating system²⁰	Accessories		
- Microsoft [®] Windows [®] Vista Business Edition (32-bit)	1GB PC2-5300 CL5 NP DDR2 UDIMM	73P4984	
	2GB PC2-5300 CL5 NP DDR2 UDIMM	73P4985	
Preloaded applications⁵	1GB PC2-6400 NP DDR2 UDIMM	41U2977	
• Rescue and Recovery [™]	2GB PC2-6400 NP DDR2 UDIMM	41U2978	
• Client Security Solution [™]	250GB SATA 3.0Gb/s Disk (7200 rpm)	41N3015	
• ThinkVantage Productivity Center	500GB SATA 3.0Gb/s Disk (7200 rpm)	43R1990	
• ThinkVantage System Update	USB Portable Diskette Drive	05K9276	
• System Migration Assistant	USB 2.0 Lenovo Multimedia Headset	40Y8518	
• Norton Internet Security [™] (90 days of virus definitions)	USB 2.0 Lenovo Webcam	40Y8519	
• Diskeeper [®] Home	USB 2.0 Essential Memory Key 32GB	45K1258	
• PC-Doctor [™] (diagnostics)	USB 2.0 Ultra Secure Memory Key 2GB	45J5916	
• Adobe [®] Reader	USB 2.0 Ultra Secure Memory Key 4GB	45J5917	
• Windows Live [™] Toolbar	USB 2.0 Ultra Secure Memory Key 8GB	45J5918	
• Windows Live Search	USB 2.0 Portable 160GB Hard Disk	43R1784	
• Picasa from Google	USB 2.0 Portable Secure 320GB Hard Disk	43R2019	
• Microsoft Office 2007 Trial (60-day)	ThinkVision [®] L1940p Wide 19" Monitor	4424HB6	
• Sonic RecordNow and Drive Letter Access (DVD±RW)	ThinkVision L2240p Wide 22" Monitor	4422HB6	
• Corel [®] WinDVD [®] (DVD, DVD±RW)	ThinkVision L2440p Wide 24" Monitor	4420HB2	
	Wireless Kbd & Opt Wheel Mouse (via USB)	73P4067	
	Laser Tilt Wheel Mouse (USB, PS/2)	41U3074	
	Kensington Cable Lock from Lenovo	73P2582	
	ADD2 DVI-I PCIe Connection Adapter	73P2516	
	ADD2 DVI-D Monitor Connection (HDCP)	43R1985	
	ATI [™] Radeon [™] HD 2400 Pro 128MB	43R1961	
	ATI Radeon HD 2400 XT 256MB	43R1962	
	ATI Radeon HD 2600 XT 512MB	43R1963	
	NVIDIA [®] Quadro [®] 256MB NVS 290	43R1765	
	NVIDIA Quadro 256MB FX 370	43R1766	
	NVIDIA Quadro 512MB FX 1700	43R1767	
	Acc Guide in pdf lenovo.com/accessoriesguide		
	Other accessories at lenovo.com/accessories		
		Supports ThinkVantage [®] technologies	
		RoHS-compliant	
		Limited Warranty¹	
		↪ 3-year parts and labor	
		↪ International Warranty Service⁹	
		↪ Customer Replaceable Unit (CRU) parts only (with limited onsite service for selected parts³, 8 am - 5 pm, Mon - Fri coverage excluding holidays, next business day response time)	
		↪ Onsite service upgrade options (in eligible locations):⁷	
		• 3-year LOR 9x5, 4 hour response (ThinkPlus [™] part number 41C9192)	
		• 3-year LOR 24x7, 4 hour response (ThinkPlus part number 41C9193)	
		• 4-year LOR 9x5, Next Business Day (ThinkPlus part number 41C9194)	
		• 4-year LOR 9x5, 4 hour response (ThinkPlus part number 41C9195)	
		• 4-year LOR 24x7, 4 hour response (ThinkPlus part number 41C9196)	
		↪ ThinkPlus services at lenovo.com/thinkplus/warranty	
		↪ Post warranty maintenance services available	
		↪ 24 hour x 7 day¹⁴ toll-free support during the warranty period¹ via 800-426-7378	

See footnotes for important warranty information
US models announced October 21, 2008

Name	Type-model	Slot x bay	Processor	GHz	L2 cache	Core	Memory ⁶	SATA disk	2nd Disk Bay	SATA optical	Graphics	ENERGY STAR 4.0	Vista preload	Vista logo	Global Educ	Avail date
M57e	9356-ADU	4x4	Core 2 Duo E4600	2.40	2MB	Dual	1GB	160GB ²	None	Combo	GMA	ES40	Bus32	Basic	Gbl	Mar 08
M57e	9356-AFU	4x4	Core 2 Duo E4600	2.40	2MB	Dual	1GB	160GB	None	Combo	GMA+ADD2	ES40	Bus32	Basic	Gbl	Mar 08
M57e	9356-AEU	4x4	Core 2 Duo E8200	2.66	6MB	Dual	1GB	160GB	None	Combo	GMA	ES40	Bus32	Basic	Gbl	Mar 08
M57e	9356-AGU	4x4	Core 2 Duo E8400	3.00	6MB	Dual	2GB	250GB	None	DVD±RW	GMA+ADD2	ES40	Bus32	Prem	Gbl	Mar 08

• **These models have a 3-year limited warranty¹**

Positioning Processor	Mainstream enterprise stability and manageability Intel® Core™ 2 Duo Processor E4600 with dual-core , Intel 64 Technology, Execute Disable Bit, EIST, 800MHz system bus, and 2MB shared L2 cache or Intel Core 2 Duo Processor E8200 or E8400 with dual-core , Intel 64 Technology, Virtualization Technology, Execute Disable Bit, EIST, TXT, and 1333MHz system bus with 6MB shared L2 cache Processor in FC-LGA6 or FC-LGA8 package in LGA775 socket										Tower																																																																				
Implementation	1GB or 2GB std, 4GB max ⁸ , PC2-5300 667MHz DDR2, non-parity, dual-channel capable, two 240-pin DIMM sockets; <i>Italics:</i> standard memory in both sockets; no sockets avail; <i>Non-italics:</i> standard memory in one socket; one socket available										<ul style="list-style-type: none"> Business black color; metal case 6.9" W X 17.3" D X 15.8" H 175mm W X 440mm D X 402mm H 24.2 lb (11.0 kg) in max configuration Handle on top front Toolless cover removal Toolless disk, diskette drive, optical drive removal Toolless adapter retention 																																																																				
Memory	All: Intel Graphics Media Accelerator 3100 (GMA 3100) , integrated graphics in G31, uses main memory (up to 256MB), one analog VGA DB-15 connector Some: ADD2 DVI-I PCIe Connection Adapter , PCI Express [®] adapter in PCIe x16 slot, provides DVI-I connector to support second monitor, no DVI-to-VGA dongle										Bay ① 5.25", 1.6" high, access, std optical Bay ② 5.25", 1.6" high, access, open Bay ③ 3.5", 1" high, access, open (reader/diskette) Bay ④ 3.5", 1" high, no access, std disk																																																																				
Graphics	SATA disk 160GB or 250GB , SATA 3.0Gb/s 7200 rpm, vibration dampening SATA controller Serial ATA, SATA 3.0Gb/s, integrated in ICH7 SATA Combo <i>Some:</i> CD-RW/DVD-ROM Combo SATA 1.5Gb/s Drive SATA DVD±RW <i>Some:</i> Super Multi-Burner DL DVD±RW SATA 1.5Gb/s Drive (41N5620) SATA cables Two SATA cables (each 1-drop to device), four SATA connectors on planar eSATA port None EIDE controller Enhanced IDE, ATA-100, integrated in ICH7, one EIDE connector on planar Diskette drive None Media reader None										Slot 1: half-length, full-height, PCI Express x16 (75w max) [*] Slot 2: half-length, full-height, PCI Express x1 Slot 3: half-length, full-height, 32-bit PCI 2.3 Slot 4: half-length, full-height, 32-bit PCI 2.3 * used in some models																																																																				
Chipset	Intel G31 Express Chipset ; I/O Controller Hub 7 (ICH7) for SATA 3.0Gb/s, ATA-100 EIDE, PCI Express x1, PCI 2.3, USB, LPC bus / ITE Tech [®] IT8718 Super I/O for serial, parallel, keyboard, mouse functions										Security <ul style="list-style-type: none"> One lock to secure both cover and entire system to fixed object: <ul style="list-style-type: none"> Padlock loop (in rear for opt padlock) Security slot (in rear for optional Kensington[®] Microsaver[®] cable) Power-on password Administrator password Hard disk password Boot sequence control Boot without keyboard, mouse, diskette Serial port I/O control Parallel port I/O control USB port disablement 																																																																				
Front ports	Two USB 2.0, microphone (stereo, 3.5mm), headphone (stereo, 3.5mm)										Supports ThinkVantage [®] technologies																																																																				
Rear ports	Four USB 2.0, serial (9-pin), parallel (25-pin), keyboard (PS/2), mouse (PS/2), ethernet (RJ-45), monitor (VGA DB-15, DVI-I in some models)										EPEAT [™] Gold rating ENERGY STAR 4.0-compliant RoHS-compliant																																																																				
Internal connector	Two USB 2.0 planar connectors (one used; one open for media reader)										Limited Warranty¹ <ul style="list-style-type: none"> 3-year parts and labor International Warranty Service⁹ Customer Replaceable Unit (CRU) parts only (with limited onsite service for selected parts³, 8 am - 5 pm, Mon - Fri coverage excluding holidays, next business day response time) Onsite service upgrade options (in eligible locations):⁷ <ul style="list-style-type: none"> 3-year LOR 9x5, 4 hour response (ThinkPlus[™] part number 41C9192) 3-year LOR 24x7, 4 hour response (ThinkPlus part number 41C9193) 4-year LOR 9x5, Next Business Day (ThinkPlus part number 41C9194) 4-year LOR 9x5, 4 hour response (ThinkPlus part number 41C9195) 4-year LOR 24x7, 4 hour response (ThinkPlus part number 41C9196) ThinkPlus services at lenovo.com/thinkplus/warranty Post warranty maintenance services available 24 hour x 7 day¹⁴ toll-free support during the warranty period¹ via 800-426-7378 																																																																				
Rear audio ports	Line-in (stereo, 3.5mm), line-out (stereo, 3.5mm), microphone (stereo, 3.5mm)																																																																														
Audio	High Definition (HD) Audio, Realtek [®] ALC662 codec																																																																														
Speaker	One internal speaker for business audio																																																																														
Ethernet	Gigabit ethernet on planar, Marvell [®] 88E8056, PCIe x1, Wake on LAN [®]																																																																														
Intel AMT	None																																																																														
Modem	None																																																																														
Security chip	None																																																																														
Keyboard	Preferred Pro USB Keyboard (USB connector), 104-key, black, Lenovo logo																																																																														
Mouse	Optical Wheel Mouse (USB connector), 400 dpi, black, Lenovo logo																																																																														
Power supply	280 watts with variable speed fan, autosensing, 80% PSU																																																																														
Preloaded operating system ²⁰	Accessories <table border="0"> <tr> <td>- Microsoft[®] Windows[®] Vista[®] Business Edition (32-bit)</td> <td>1GB PC2-5300 CL5 NP DDR2 UDIMM</td> <td>73P4984</td> </tr> <tr> <td></td> <td>2GB PC2-5300 CL5 NP DDR2 UDIMM</td> <td>73P4985</td> </tr> <tr> <td></td> <td>1GB PC2-6400 NP DDR2 UDIMM</td> <td>41U2977</td> </tr> <tr> <td></td> <td>2GB PC2-6400 NP DDR2 UDIMM</td> <td>41U2978</td> </tr> <tr> <td></td> <td>500GB SATA 3.0Gb/s Disk (7200 rpm)</td> <td>43R1990</td> </tr> <tr> <td></td> <td>USB 2.0 Lenovo Multimedia Headset</td> <td>40Y8518</td> </tr> <tr> <td></td> <td>USB 2.0 Lenovo Webcam</td> <td>40Y8519</td> </tr> <tr> <td></td> <td>USB 2.0 Essential Memory Key 32GB</td> <td>45K1258</td> </tr> <tr> <td></td> <td>USB 2.0 Ultra Secure Memory Key 8GB</td> <td>45J5918</td> </tr> <tr> <td></td> <td>USB 2.0 Portable Secure 320GB Hard Disk</td> <td>43R2019</td> </tr> <tr> <td></td> <td>ThinkVision[®] L2440p Wide 24" Monitor</td> <td>4420HB2</td> </tr> <tr> <td></td> <td>Wireless Kbd & Opt Wheel Mouse (via USB)</td> <td>73P4067</td> </tr> <tr> <td></td> <td>Kensington Cable Lock from Lenovo</td> <td>73P2582</td> </tr> <tr> <td></td> <td>ADD2 DVI-I PCIe Connection Adapter</td> <td>73P2516</td> </tr> <tr> <td></td> <td>ADD2 DVI-D Monitor Connection (HDCP)</td> <td>43R1985</td> </tr> <tr> <td></td> <td>ATI[™] Radeon[™] HD 2400 Pro 128MB</td> <td>43R1961</td> </tr> <tr> <td></td> <td>ATI Radeon HD 2400 XT 256MB</td> <td>43R1962</td> </tr> <tr> <td></td> <td>ATI Radeon HD 2600 XT 512MB</td> <td>43R1963</td> </tr> <tr> <td></td> <td>NVIDIA[®] Quadro[®] 256MB NVS 290</td> <td>43R1765</td> </tr> <tr> <td></td> <td>NVIDIA Quadro 256MB FX 370</td> <td>43R1766</td> </tr> <tr> <td></td> <td>NVIDIA Quadro 512MB FX 1700</td> <td>43R1767</td> </tr> <tr> <td></td> <td>Acc Guide in pdf lenovo.com/accessoriesguide</td> <td></td> </tr> <tr> <td></td> <td>Other accessories at lenovo.com/accessories</td> <td></td> </tr> </table>										- Microsoft [®] Windows [®] Vista [®] Business Edition (32-bit)	1GB PC2-5300 CL5 NP DDR2 UDIMM	73P4984		2GB PC2-5300 CL5 NP DDR2 UDIMM	73P4985		1GB PC2-6400 NP DDR2 UDIMM	41U2977		2GB PC2-6400 NP DDR2 UDIMM	41U2978		500GB SATA 3.0Gb/s Disk (7200 rpm)	43R1990		USB 2.0 Lenovo Multimedia Headset	40Y8518		USB 2.0 Lenovo Webcam	40Y8519		USB 2.0 Essential Memory Key 32GB	45K1258		USB 2.0 Ultra Secure Memory Key 8GB	45J5918		USB 2.0 Portable Secure 320GB Hard Disk	43R2019		ThinkVision [®] L2440p Wide 24" Monitor	4420HB2		Wireless Kbd & Opt Wheel Mouse (via USB)	73P4067		Kensington Cable Lock from Lenovo	73P2582		ADD2 DVI-I PCIe Connection Adapter	73P2516		ADD2 DVI-D Monitor Connection (HDCP)	43R1985		ATI [™] Radeon [™] HD 2400 Pro 128MB	43R1961		ATI Radeon HD 2400 XT 256MB	43R1962		ATI Radeon HD 2600 XT 512MB	43R1963		NVIDIA [®] Quadro [®] 256MB NVS 290	43R1765		NVIDIA Quadro 256MB FX 370	43R1766		NVIDIA Quadro 512MB FX 1700	43R1767		Acc Guide in pdf lenovo.com/accessoriesguide			Other accessories at lenovo.com/accessories	
- Microsoft [®] Windows [®] Vista [®] Business Edition (32-bit)	1GB PC2-5300 CL5 NP DDR2 UDIMM	73P4984																																																																													
	2GB PC2-5300 CL5 NP DDR2 UDIMM	73P4985																																																																													
	1GB PC2-6400 NP DDR2 UDIMM	41U2977																																																																													
	2GB PC2-6400 NP DDR2 UDIMM	41U2978																																																																													
	500GB SATA 3.0Gb/s Disk (7200 rpm)	43R1990																																																																													
	USB 2.0 Lenovo Multimedia Headset	40Y8518																																																																													
	USB 2.0 Lenovo Webcam	40Y8519																																																																													
	USB 2.0 Essential Memory Key 32GB	45K1258																																																																													
	USB 2.0 Ultra Secure Memory Key 8GB	45J5918																																																																													
	USB 2.0 Portable Secure 320GB Hard Disk	43R2019																																																																													
	ThinkVision [®] L2440p Wide 24" Monitor	4420HB2																																																																													
	Wireless Kbd & Opt Wheel Mouse (via USB)	73P4067																																																																													
	Kensington Cable Lock from Lenovo	73P2582																																																																													
	ADD2 DVI-I PCIe Connection Adapter	73P2516																																																																													
	ADD2 DVI-D Monitor Connection (HDCP)	43R1985																																																																													
	ATI [™] Radeon [™] HD 2400 Pro 128MB	43R1961																																																																													
	ATI Radeon HD 2400 XT 256MB	43R1962																																																																													
	ATI Radeon HD 2600 XT 512MB	43R1963																																																																													
	NVIDIA [®] Quadro [®] 256MB NVS 290	43R1765																																																																													
	NVIDIA Quadro 256MB FX 370	43R1766																																																																													
	NVIDIA Quadro 512MB FX 1700	43R1767																																																																													
	Acc Guide in pdf lenovo.com/accessoriesguide																																																																														
	Other accessories at lenovo.com/accessories																																																																														

See footnotes for important warranty information
US models announced March 18, 2008

Name	Type-model	Slot x bay	Processor	GHz	L2 cache	Core	Memory ^o	SATA disk	2nd Disk Bay	SATA optical	Graphics	ENERGY STAR 4.0	Preload	Vista logo	Global Educ	Avail date
ES	M57e 9356-B5U	4x5	Core 2 Duo E7200	2.53	3MB	Dual	1GB	160GB ²	Bay	DVD	GMA	ES40	XP Pro	No	No	Sep 08
	M57e 9356-B1U	4x4	Core 2 Duo E7200	2.53	3MB	Dual	1GB	160GB		DVD±RW	GMA	ES40	Bus32	Basic	No	Jun 08
ES	M57e 9356-B7U	4x5	Core 2 Duo E7300	2.66	3MB	Dual	1GB	160GB	Bay	DVD±RW	GMA	ES40	Bus32	Prem	No	Sep 08

• **These models have a 3-year limited warranty¹**

Positioning Processor	Mainstream enterprise stability and manageability Intel® Core™ 2 Duo Processor E7200 or E7300 with dual-core, Intel 64 Technology, Execute Disable Bit, EIST, and 1066MHz system bus with 3MB L2 cache										Tower																																																											
Implementation	Processor in FC-LGA8 package in LGA775 socket										<ul style="list-style-type: none"> • Business black color; metal case • 6.9" W X 17.3" D X 15.8" H • 175mm W X 440mm D X 402mm H • 24.2 lb (11.0 kg) in max configuration • Handle on top front • Toolless cover removal • Toolless disk, diskette drive, optical drive removal • Toolless adapter retention 																																																											
Memory	1GB std, 4GB max⁸, PC2-5300 667MHz DDR2 , non-parity, dual-channel capable, two 240-pin DIMM sockets; <i>Non-italics:</i> standard memory in one socket; one socket available										Bay ① 5.25", 1.6" high, access, std optical Bay ② 5.25", 1.6" high, access, open Bay ③ 3.5", 1" high, access, open (reader/diskette) Bay ④ 3.5", 1" high, no access, std disk Bay ⑤ 3.5", 1" high, no access, opt disk*																																																											
Graphics	Intel Graphics Media Accelerator 3100 (GMA 3100) , integrated graphics in G31, uses main memory (up to 256MB), one analog VGA DB-15 connector, supports dual independent display with optional ADD2 adapter										* 2nd Disk Bay is only available on some models Slot 1: half-length, full-height, PCI Express x16 (75w max) Slot 2: half-length, full-height, PCI Express x1 Slot 3: half-length, full-height, 32-bit PCI 2.3 Slot 4: half-length, full-height, 32-bit PCI 2.3																																																											
SATA disk	160GB , SATA 3.0Gb/s 7200 rpm, vibration dampening mounts										Security <ul style="list-style-type: none"> • One lock to secure both cover and entire system to fixed object: <ul style="list-style-type: none"> - Padlock loop (in rear for opt padlock) - Security slot (in rear for optional Kensington® Microsaver® cable) • Power-on password • Administrator password • Hard disk password • Boot sequence control • Boot without keyboard, mouse, diskette • Serial port I/O control • Parallel port I/O control • USB port disablement 																																																											
SATA controller	Serial ATA, SATA 3.0Gb/s, integrated in ICH7																																																																					
SATA DVD	<i>Some:</i> DVD-ROM DL SATA 1.5Gb/s 16X-48X Max ⁴ (41N5618)																																																																					
SATA DVD±RW	<i>Some:</i> Super Multi-Burner DL DVD±RW SATA Drive (41N5620)																																																																					
SATA cables	Two SATA cables (each 1-drop to device), four SATA connectors																																																																					
eSATA port	None																																																																					
EIDE controller	Enhanced IDE, ATA-100, integrated in ICH7, one EIDE connector																																																																					
Diskette drive	None																																																																					
Media reader	None																																																																					
Chipset	Intel G31 Express Chipset: I/O Controller Hub 7 (ICH7) for SATA 3.0Gb/s, ATA-100 EIDE, PCI Express® x1, PCI 2.3, USB, LPC bus / ITE Tech® IT8718 Super I/O for serial, parallel, keyboard, mouse functions												Supports ThinkVantage® technologies EPEAT™ Gold rating ENERGY STAR 4.0-compliant RoHS-compliant Limited Warranty¹ <ul style="list-style-type: none"> ↔ 3-year parts and labor ↔ International Warranty Service⁹ ↔ Customer Replaceable Unit (CRU) parts only (with limited onsite service for selected parts³, 8 am - 5 pm, Mon - Fri coverage excluding holidays, next business day response time) ↔ Onsite service upgrade options (in eligible locations):⁷ <ul style="list-style-type: none"> • 3-year LOR 9x5, 4 hour response (ThinkPlus™ part number 41C9192) • 3-year LOR 24x7, 4 hour response (ThinkPlus part number 41C9193) • 4-year LOR 9x5, Next Business Day (ThinkPlus part number 41C9194) • 4-year LOR 9x5, 4 hour response (ThinkPlus part number 41C9195) • 4-year LOR 24x7, 4 hour response (ThinkPlus part number 41C9196) ↔ ThinkPlus services at lenovo.com/thinkplus/warranty ↔ Post warranty maintenance services available ↔ 24 hour x 7 day¹⁴ toll-free support during the warranty period¹ via 800-426-7378 																																																									
Front ports	Two USB 2.0, microphone (stereo, 3.5mm), headphone (stereo, 3.5mm)																																																																					
Rear ports	Four USB 2.0, serial (9-pin), parallel (25-pin), keyboard (PS/2), mouse (PS/2), ethernet (RJ-45), monitor (VGA DB-15)																																																																					
Internal connector	Two USB 2.0 planar connectors (one used; one open for media reader)																																																																					
Rear audio ports	Line-in (stereo, 3.5mm), line-out (stereo, 3.5mm), microphone (stereo, 3.5mm)																																																																					
Audio	High Definition (HD) Audio, Realtek® ALC662 codec																																																																					
Speaker	One internal speaker for business audio																																																																					
Ethernet	Gigabit ethernet on planar, Marvell® 88E8056, PCIe x1, Wake on LAN®																																																																					
Intel AMT	None																																																																					
Modem	None																																																																					
Security chip	None																																																																					
Keyboard	Preferred Pro USB Keyboard (USB connector), 104-key, black, Lenovo logo																																																																					
Mouse	Optical Wheel Mouse (USB connector), 400 dpi, black, Lenovo logo																																																																					
Power supply	280 watts with variable speed fan, autosensing, 80% PSU																																																																					
Preloaded operating system²⁰	<ul style="list-style-type: none"> - <i>Some:</i> Microsoft® Windows® XP Professional with Vista® COA - <i>Some:</i> Microsoft Windows Vista Business Edition (32-bit) 										Accessories <table border="0"> <tr><td>1GB PC2-5300 CL5 NP DDR2 UDIMM</td><td>73P4984</td></tr> <tr><td>2GB PC2-5300 CL5 NP DDR2 UDIMM</td><td>73P4985</td></tr> <tr><td>1GB PC2-6400 NP DDR2 UDIMM</td><td>41U2977</td></tr> <tr><td>2GB PC2-6400 NP DDR2 UDIMM</td><td>41U2978</td></tr> <tr><td>250GB SATA 3.0Gb/s Disk (7200 rpm)</td><td>41N3015</td></tr> <tr><td>500GB SATA 3.0Gb/s Disk (7200 rpm)</td><td>43R1990</td></tr> <tr><td>USB Portable Diskette Drive</td><td>05K9276</td></tr> <tr><td>USB 2.0 Lenovo Multimedia Headset</td><td>40Y8518</td></tr> <tr><td>USB 2.0 Lenovo Webcam</td><td>40Y8519</td></tr> <tr><td>USB 2.0 Essential Memory Key 32GB</td><td>45K1258</td></tr> <tr><td>USB 2.0 Ultra Secure Memory Key 2GB</td><td>45J5916</td></tr> <tr><td>USB 2.0 Ultra Secure Memory Key 4GB</td><td>45J5917</td></tr> <tr><td>USB 2.0 Ultra Secure Memory Key 8GB</td><td>45J5918</td></tr> <tr><td>USB 2.0 Portable 160GB Hard Disk</td><td>43R1784</td></tr> <tr><td>USB 2.0 Portable Secure 320GB Hard Disk</td><td>43R2019</td></tr> <tr><td>ThinkVision® L1940p Wide 19" Monitor</td><td>4424HB6</td></tr> <tr><td>ThinkVision L2240p Wide 22" Monitor</td><td>4422HB6</td></tr> <tr><td>ThinkVision L2440p Wide 24" Monitor</td><td>4420HB2</td></tr> <tr><td>Wireless Kbd & Opt Wheel Mouse (via USB)</td><td>73P4067</td></tr> <tr><td>Laser Tilt Wheel Mouse (USB, PS/2)</td><td>41U3074</td></tr> <tr><td>Kensington Cable Lock from Lenovo</td><td>73P2582</td></tr> <tr><td>ADD2 DVI-I PCIe Connection Adapter</td><td>73P2516</td></tr> <tr><td>ADD2 DVI-D Monitor Connection (HDCP)</td><td>43R1985</td></tr> <tr><td>ATI Radeon™ HD 2400 Pro 128MB</td><td>43R1961</td></tr> <tr><td>ATI Radeon HD 2400 XT 256MB</td><td>43R1962</td></tr> <tr><td>ATI Radeon HD 2600 XT 512MB</td><td>43R1963</td></tr> <tr><td>NVIDIA® Quadro® 256MB NVS 290</td><td>43R1765</td></tr> <tr><td>NVIDIA Quadro 256MB FX 370</td><td>43R1766</td></tr> <tr><td>NVIDIA Quadro 512MB FX 1700</td><td>43R1767</td></tr> </table> Acc Guide in pdf lenovo.com/accessoriesguide Other accessories at lenovo.com/accessories		1GB PC2-5300 CL5 NP DDR2 UDIMM	73P4984	2GB PC2-5300 CL5 NP DDR2 UDIMM	73P4985	1GB PC2-6400 NP DDR2 UDIMM	41U2977	2GB PC2-6400 NP DDR2 UDIMM	41U2978	250GB SATA 3.0Gb/s Disk (7200 rpm)	41N3015	500GB SATA 3.0Gb/s Disk (7200 rpm)	43R1990	USB Portable Diskette Drive	05K9276	USB 2.0 Lenovo Multimedia Headset	40Y8518	USB 2.0 Lenovo Webcam	40Y8519	USB 2.0 Essential Memory Key 32GB	45K1258	USB 2.0 Ultra Secure Memory Key 2GB	45J5916	USB 2.0 Ultra Secure Memory Key 4GB	45J5917	USB 2.0 Ultra Secure Memory Key 8GB	45J5918	USB 2.0 Portable 160GB Hard Disk	43R1784	USB 2.0 Portable Secure 320GB Hard Disk	43R2019	ThinkVision® L1940p Wide 19" Monitor	4424HB6	ThinkVision L2240p Wide 22" Monitor	4422HB6	ThinkVision L2440p Wide 24" Monitor	4420HB2	Wireless Kbd & Opt Wheel Mouse (via USB)	73P4067	Laser Tilt Wheel Mouse (USB, PS/2)	41U3074	Kensington Cable Lock from Lenovo	73P2582	ADD2 DVI-I PCIe Connection Adapter	73P2516	ADD2 DVI-D Monitor Connection (HDCP)	43R1985	ATI Radeon™ HD 2400 Pro 128MB	43R1961	ATI Radeon HD 2400 XT 256MB	43R1962	ATI Radeon HD 2600 XT 512MB	43R1963	NVIDIA® Quadro® 256MB NVS 290	43R1765	NVIDIA Quadro 256MB FX 370	43R1766	NVIDIA Quadro 512MB FX 1700	43R1767
1GB PC2-5300 CL5 NP DDR2 UDIMM	73P4984																																																																					
2GB PC2-5300 CL5 NP DDR2 UDIMM	73P4985																																																																					
1GB PC2-6400 NP DDR2 UDIMM	41U2977																																																																					
2GB PC2-6400 NP DDR2 UDIMM	41U2978																																																																					
250GB SATA 3.0Gb/s Disk (7200 rpm)	41N3015																																																																					
500GB SATA 3.0Gb/s Disk (7200 rpm)	43R1990																																																																					
USB Portable Diskette Drive	05K9276																																																																					
USB 2.0 Lenovo Multimedia Headset	40Y8518																																																																					
USB 2.0 Lenovo Webcam	40Y8519																																																																					
USB 2.0 Essential Memory Key 32GB	45K1258																																																																					
USB 2.0 Ultra Secure Memory Key 2GB	45J5916																																																																					
USB 2.0 Ultra Secure Memory Key 4GB	45J5917																																																																					
USB 2.0 Ultra Secure Memory Key 8GB	45J5918																																																																					
USB 2.0 Portable 160GB Hard Disk	43R1784																																																																					
USB 2.0 Portable Secure 320GB Hard Disk	43R2019																																																																					
ThinkVision® L1940p Wide 19" Monitor	4424HB6																																																																					
ThinkVision L2240p Wide 22" Monitor	4422HB6																																																																					
ThinkVision L2440p Wide 24" Monitor	4420HB2																																																																					
Wireless Kbd & Opt Wheel Mouse (via USB)	73P4067																																																																					
Laser Tilt Wheel Mouse (USB, PS/2)	41U3074																																																																					
Kensington Cable Lock from Lenovo	73P2582																																																																					
ADD2 DVI-I PCIe Connection Adapter	73P2516																																																																					
ADD2 DVI-D Monitor Connection (HDCP)	43R1985																																																																					
ATI Radeon™ HD 2400 Pro 128MB	43R1961																																																																					
ATI Radeon HD 2400 XT 256MB	43R1962																																																																					
ATI Radeon HD 2600 XT 512MB	43R1963																																																																					
NVIDIA® Quadro® 256MB NVS 290	43R1765																																																																					
NVIDIA Quadro 256MB FX 370	43R1766																																																																					
NVIDIA Quadro 512MB FX 1700	43R1767																																																																					
Preloaded applications⁵ (all OSes) <ul style="list-style-type: none"> • Rescue and Recovery™ • Client Security Solution™ • ThinkVantage Productivity Center • ThinkVantage System Update • System Migration Assistant • Norton Internet Security™ (90 days of virus definitions) • Diskeeper® Home • PC-Doctor™ (diagnostics) • Adobe® Reader • Windows Live™ Toolbar • Windows Live Search • Picasa from Google • Microsoft Office 2007 Trial (60-day) • Multimedia Center for Think Offerings (DVD) (XP) • Sonic RecordNow and Drive Letter Access (DVD±RW) • Corel® WinDVD® (DVD, DVD±RW) 																																																																						

See footnotes for important warranty information

ES US models announced August 19, 2008; previous model on June 24, 2008

ThinkCentre® M57e Tower (6176) - ENERGY STAR® 4.0 (GMP)

Personal Systems Reference (PSREF)

Name	Type-model	Slot x bay	Processor	GHz	L2 cache	Core	Memory ⁸	SATA disk	2nd Disk Bay	SATA optical	Graphics	ENERGY STAR 4.0	Vista preload	Global (G) GMP (P)	Avail date
M57e	6176-B1U	4x4	Core 2 Duo E8400	3.00	6MB	Dual	1GB	160GB ²	None	DVD±RW	GMA	ES40	Business32	G P	Jul 08

• This model is part of the Global Models Plus (GMP) program with limited onsite service³ 3-year limited warranty

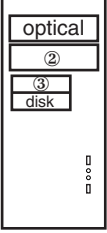
Positioning Processor	Mainstream enterprise stability and manageability Intel® Core™ 2 Duo Processor E8400 with dual-core, Intel 64 Technology, Virtualization Technology, Execute Disable Bit, EIST, TXT, and 1333MHz system bus with 6MB L2 cache Processor in FC-LGA8 package in LGA775 socket										Tower <ul style="list-style-type: none"> • Business black color; metal case • 6.9" W X 17.3" D X 15.8" H • 175mm W X 440mm D X 402mm H • 24.2 lb (11.0 kg) in max configuration • Handle on top front • Toolless cover removal • Toolless disk, diskette drive, optical drive removal • Toolless adapter retention 																																																											
Implementation	Processor in FC-LGA8 package in LGA775 socket										<ul style="list-style-type: none"> • 6.9" W X 17.3" D X 15.8" H • 175mm W X 440mm D X 402mm H • 24.2 lb (11.0 kg) in max configuration • Handle on top front • Toolless cover removal • Toolless disk, diskette drive, optical drive removal • Toolless adapter retention 																																																											
Memory	1GB std, 4GB max ⁹ , PC2-5300 667MHz DDR2, non-parity, dual-channel capable, two 240-pin DIMM sockets; <i>Non-italics</i> : standard memory in one socket; one socket available										<ul style="list-style-type: none"> Bay ① 5.25", 1.6" high, access, std optical Bay ② 5.25", 1.6" high, access, open Bay ③ 3.5", 1" high, access, open (reader/diskette) Bay ④ 3.5", 1" high, no access, std disk 																																																											
Graphics	Intel Graphics Media Accelerator 3100 (GMA 3100), integrated graphics in G31, uses main memory (up to 256MB), one analog VGA DB-15 connector, supports dual independent display with optional ADD2 adapter										<ul style="list-style-type: none"> Slot 1: half-length, full-height, PCI Express x16 (75w max) Slot 2: half-length, full-height, PCI Express x1 Slot 3: half-length, full-height, 32-bit PCI 2.3 Slot 4: half-length, full-height, 32-bit PCI 2.3 																																																											
SATA disk	160GB, SATA 3.0Gb/s 7200 rpm, vibration dampening mounts																																																																					
SATA controller	Serial ATA, SATA 3.0Gb/s, integrated in ICH7																																																																					
SATA DVD±RW	Super Multi-Burner DL DVD±RW SATA 1.5Gb/s Drive (41N5620)																																																																					
SATA cables	Two SATA cables (each 1-drop to device), four SATA connectors																																																																					
eSATA port	None																																																																					
EIDE controller	Enhanced IDE, ATA-100, integrated in ICH7, one EIDE connector																																																																					
Diskette drive	None																																																																					
Media reader	None																																																																					
Chipset	Intel G31 Express Chipset; I/O Controller Hub 7 (ICH7) for SATA 3.0Gb/s, ATA-100 EIDE, PCI Express [®] x1, PCI 2.3, USB, LPC bus / ITE Tech [®] IT8718 Super I/O for serial, parallel, keyboard, mouse functions										Security <ul style="list-style-type: none"> • One lock to secure both cover and entire system to fixed object: <ul style="list-style-type: none"> - Padlock loop (in rear for opt padlock) - Security slot (in rear for optional Kensington[®] Microsaver[®] cable) • Power-on password • Administrator password • Hard disk password • Boot sequence control • Boot without keyboard, mouse, diskette • Serial port I/O control • Parallel port I/O control • USB port disablement 																																																											
Front ports	Two USB 2.0, microphone (stereo, 3.5mm), headphone (stereo, 3.5mm)																																																																					
Rear ports	Four USB 2.0, serial (9-pin), parallel (25-pin), keyboard (PS/2), mouse (PS/2), ethernet (RJ-45), monitor (VGA DB-15)																																																																					
Internal connector	Two USB 2.0 planar connectors (one used; one open for media reader)																																																																					
Rear audio ports	Line-in (stereo, 3.5mm), line-out (stereo, 3.5mm), microphone (stereo, 3.5mm)																																																																					
Audio	High Definition (HD) Audio, Realtek [®] ALC662 codec																																																																					
Speaker	One internal speaker for business audio																																																																					
Ethernet	Gigabit ethernet on planar, Marvell [®] 88E8056, PCIe x1, Wake on LAN [®]																																																																					
Intel AMT	None																																																																					
Modem	None																																																																					
Security chip	None																																																																					
Keyboard	Preferred Pro USB Keyboard (USB connector), 104-key, black, Lenovo logo																																																																					
Mouse	Optical Wheel Mouse (USB connector), 400 dpi, black, Lenovo logo																																																																					
Power supply	280 watts with variable speed fan, autosensing, 80% PSU																																																																					
Preloaded operating system²⁰	<ul style="list-style-type: none"> - Microsoft[®] Windows[®] Vista[®] Business Edition (32-bit) ◇ Vista Basic logo 										Accessories <table border="0"> <tr><td>1GB PC2-5300 CL5 NP DDR2 UDIMM</td><td>73P4984</td></tr> <tr><td>2GB PC2-5300 CL5 NP DDR2 UDIMM</td><td>73P4985</td></tr> <tr><td>1GB PC2-6400 NP DDR2 UDIMM</td><td>41U2977</td></tr> <tr><td>2GB PC2-6400 NP DDR2 UDIMM</td><td>41U2978</td></tr> <tr><td>250GB SATA 3.0Gb/s Disk (7200 rpm)</td><td>41N3015</td></tr> <tr><td>500GB SATA 3.0Gb/s Disk (7200 rpm)</td><td>43R1990</td></tr> <tr><td>USB Portable Diskette Drive</td><td>05K9276</td></tr> <tr><td>USB 2.0 Lenovo Multimedia Headset</td><td>40Y8518</td></tr> <tr><td>USB 2.0 Lenovo Webcam</td><td>40Y8519</td></tr> <tr><td>USB 2.0 Essential Memory Key 32GB</td><td>45K1258</td></tr> <tr><td>USB 2.0 Ultra Secure Memory Key 2GB</td><td>45J5916</td></tr> <tr><td>USB 2.0 Ultra Secure Memory Key 4GB</td><td>45J5917</td></tr> <tr><td>USB 2.0 Ultra Secure Memory Key 8GB</td><td>45J5918</td></tr> <tr><td>USB 2.0 Portable 160GB Hard Disk</td><td>43R1784</td></tr> <tr><td>USB 2.0 Portable Secure 320GB Hard Disk</td><td>43R2019</td></tr> <tr><td>ThinkVision[®] L1940p Wide 19" Monitor</td><td>4424HB6</td></tr> <tr><td>ThinkVision L2240p Wide 22" Monitor</td><td>4422HB6</td></tr> <tr><td>ThinkVision L2440p Wide 24" Monitor</td><td>4420HB2</td></tr> <tr><td>Wireless Kbd & Opt Wheel Mouse (via USB)</td><td>73P4067</td></tr> <tr><td>Laser Tilt Wheel Mouse (USB, PS/2)</td><td>41U3074</td></tr> <tr><td>Kensington Cable Lock from Lenovo</td><td>73P2582</td></tr> <tr><td>ADD2 DVI-I PCIe Connection Adapter</td><td>73P2516</td></tr> <tr><td>ADD2 DVI-D Monitor Connection (HDCP)</td><td>43R1985</td></tr> <tr><td>ATI[™] Radeon[™] HD 2400 Pro 128MB</td><td>43R1961</td></tr> <tr><td>ATI Radeon HD 2400 XT 256MB</td><td>43R1962</td></tr> <tr><td>ATI Radeon HD 2600 XT 512MB</td><td>43R1963</td></tr> <tr><td>NVIDIA[®] Quadro[®] 256MB NVS 290</td><td>43R1765</td></tr> <tr><td>NVIDIA Quadro 256MB FX 370</td><td>43R1766</td></tr> <tr><td>NVIDIA Quadro 512MB FX 1700</td><td>43R1767</td></tr> </table>		1GB PC2-5300 CL5 NP DDR2 UDIMM	73P4984	2GB PC2-5300 CL5 NP DDR2 UDIMM	73P4985	1GB PC2-6400 NP DDR2 UDIMM	41U2977	2GB PC2-6400 NP DDR2 UDIMM	41U2978	250GB SATA 3.0Gb/s Disk (7200 rpm)	41N3015	500GB SATA 3.0Gb/s Disk (7200 rpm)	43R1990	USB Portable Diskette Drive	05K9276	USB 2.0 Lenovo Multimedia Headset	40Y8518	USB 2.0 Lenovo Webcam	40Y8519	USB 2.0 Essential Memory Key 32GB	45K1258	USB 2.0 Ultra Secure Memory Key 2GB	45J5916	USB 2.0 Ultra Secure Memory Key 4GB	45J5917	USB 2.0 Ultra Secure Memory Key 8GB	45J5918	USB 2.0 Portable 160GB Hard Disk	43R1784	USB 2.0 Portable Secure 320GB Hard Disk	43R2019	ThinkVision [®] L1940p Wide 19" Monitor	4424HB6	ThinkVision L2240p Wide 22" Monitor	4422HB6	ThinkVision L2440p Wide 24" Monitor	4420HB2	Wireless Kbd & Opt Wheel Mouse (via USB)	73P4067	Laser Tilt Wheel Mouse (USB, PS/2)	41U3074	Kensington Cable Lock from Lenovo	73P2582	ADD2 DVI-I PCIe Connection Adapter	73P2516	ADD2 DVI-D Monitor Connection (HDCP)	43R1985	ATI [™] Radeon [™] HD 2400 Pro 128MB	43R1961	ATI Radeon HD 2400 XT 256MB	43R1962	ATI Radeon HD 2600 XT 512MB	43R1963	NVIDIA [®] Quadro [®] 256MB NVS 290	43R1765	NVIDIA Quadro 256MB FX 370	43R1766	NVIDIA Quadro 512MB FX 1700	43R1767
1GB PC2-5300 CL5 NP DDR2 UDIMM	73P4984																																																																					
2GB PC2-5300 CL5 NP DDR2 UDIMM	73P4985																																																																					
1GB PC2-6400 NP DDR2 UDIMM	41U2977																																																																					
2GB PC2-6400 NP DDR2 UDIMM	41U2978																																																																					
250GB SATA 3.0Gb/s Disk (7200 rpm)	41N3015																																																																					
500GB SATA 3.0Gb/s Disk (7200 rpm)	43R1990																																																																					
USB Portable Diskette Drive	05K9276																																																																					
USB 2.0 Lenovo Multimedia Headset	40Y8518																																																																					
USB 2.0 Lenovo Webcam	40Y8519																																																																					
USB 2.0 Essential Memory Key 32GB	45K1258																																																																					
USB 2.0 Ultra Secure Memory Key 2GB	45J5916																																																																					
USB 2.0 Ultra Secure Memory Key 4GB	45J5917																																																																					
USB 2.0 Ultra Secure Memory Key 8GB	45J5918																																																																					
USB 2.0 Portable 160GB Hard Disk	43R1784																																																																					
USB 2.0 Portable Secure 320GB Hard Disk	43R2019																																																																					
ThinkVision [®] L1940p Wide 19" Monitor	4424HB6																																																																					
ThinkVision L2240p Wide 22" Monitor	4422HB6																																																																					
ThinkVision L2440p Wide 24" Monitor	4420HB2																																																																					
Wireless Kbd & Opt Wheel Mouse (via USB)	73P4067																																																																					
Laser Tilt Wheel Mouse (USB, PS/2)	41U3074																																																																					
Kensington Cable Lock from Lenovo	73P2582																																																																					
ADD2 DVI-I PCIe Connection Adapter	73P2516																																																																					
ADD2 DVI-D Monitor Connection (HDCP)	43R1985																																																																					
ATI [™] Radeon [™] HD 2400 Pro 128MB	43R1961																																																																					
ATI Radeon HD 2400 XT 256MB	43R1962																																																																					
ATI Radeon HD 2600 XT 512MB	43R1963																																																																					
NVIDIA [®] Quadro [®] 256MB NVS 290	43R1765																																																																					
NVIDIA Quadro 256MB FX 370	43R1766																																																																					
NVIDIA Quadro 512MB FX 1700	43R1767																																																																					
											Supports ThinkVantage [®] technologies																																																											
Preloaded applications⁵	<ul style="list-style-type: none"> • Rescue and Recovery[™] • Client Security Solution[™] • ThinkVantage Productivity Center • ThinkVantage System Update • System Migration Assistant • Norton Internet Security[™] (90 days of virus definitions) • Diskkeeper[®] Home • PC-Doctor[™] (diagnostics) • Adobe[®] Reader • Windows Live[™] Toolbar • Windows Live Search • Picasa from Google • Microsoft Office 2007 Trial (60-day) • Sonic RecordNow and Drive Letter Access (DVD±RW) • Corel[®] WinDVD[®] (DVD±RW) 										EPEAT [™] Gold rating ENERGY STAR 4.0-compliant RoHS-compliant																																																											
											Limited Warranty¹ <ul style="list-style-type: none"> ⇨ 3-year parts and labor ⇨ International Warranty Service⁹ ⇨ Customer Replaceable Unit (CRU) parts only (with limited onsite service for selected parts³, 8 am - 5 pm, Mon - Fri coverage excluding holidays, next business day response time) ⇨ Onsite service upgrade options (in eligible locations):⁷ <ul style="list-style-type: none"> • 4-year LOR 9x5, Next Business Day (ThinkPlus part number 41C9194) • 4-year LOR 9x5, 4 hour response (ThinkPlus part number 41C9195) • 4-year LOR 24x7, 4 hour response (ThinkPlus part number 41C9196) ⇨ ThinkPlus services at lenovo.com/thinkplus/warranty ⇨ Post warranty maintenance services available ⇨ 24 hour x 7 day¹⁴ toll-free support during the warranty period¹ via 800-426-7378 																																																											

See footnotes for important warranty information
US model announced June 24, 2008

© Lenovo
(MONA2-10) June 2008

Name	Type-model	Slot x bay	Processor	GHz	L2 cache	Core	Memory ^a	SATA disk	2nd Disk Bay	SATA optical	Graphics	Vista preload	Limited warranty ¹	Global (G) GMP (P)	Avail date
M57e	7064-AAU	4x4	Pentium E2200	2.20	1MB	Dual	1GB	160GB ²	None	Combo	GMA	Business32	3-yr	G P	Apr 08

- This model is part of the Global Models Plus (GMP) program with limited onsite service³ 3-year limited warranty

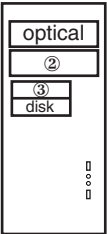
Positioning Processor	Mainstream enterprise stability and manageability Intel® Pentium® Dual-Core Processor E2200 with dual-core, Intel 64 Technology, Execute Disable Bit, EIST, and 800MHz system bus with 1MB shared L2 cache										Tower <ul style="list-style-type: none"> • Business black color; metal case • 6.9" W X 17.3" D X 15.8" H • 175mm W X 440mm D X 402mm H • 24.2 lb (11.0 kg) in max configuration • Handle on top front • Toolless cover removal • Toolless disk, diskette drive, optical drive removal • Toolless adapter retention 		
Implementation	Processor in FC-LGA6 package in LGA775 socket										<ul style="list-style-type: none"> • Bay ① 5.25", 1.6" high, access, std optical • Bay ② 5.25", 1.6" high, access, open • Bay ③ 3.5", 1" high, access, open (reader/diskette) • Bay ④ 3.5", 1" high, no access, std disk 		
Memory	1GB std , 4GB max ⁸ , PC2-5300 667MHz DDR2 , non-parity, dual-channel capable, two 240-pin DIMM sockets; <i>Non-italics</i> : standard memory in one socket; one socket available										<ul style="list-style-type: none"> • Slot 1: half-length, full-height, PCI Express x16 (75w max) • Slot 2: half-length, full-height, PCI Express x1 • Slot 3: half-length, full-height, 32-bit PCI 2.3 • Slot 4: half-length, full-height, 32-bit PCI 2.3 		
Graphics	Intel Graphics Media Accelerator 3100 (GMA 3100) , integrated graphics in G31, uses main memory (up to 256MB), one analog VGA DB-15 connector, supports dual independent display with optional ADD2 adapter												
SATA disk	160GB , SATA 3.0Gb/s 7200 rpm, vibration dampening mounts												
SATA controller	Serial ATA, SATA 3.0Gb/s, integrated in ICH7												
SATA Combo	CD-RW/DVD-ROM Combo SATA 1.5Gb/s Drive												
SATA cables	Two SATA cables (each 1-drop to device), four SATA connectors												
eSATA port	None												
EIDE controller	Enhanced IDE, ATA-100, integrated in ICH7, one EIDE connector												
Diskette drive	None												
Media reader	None												
Chipset	Intel G31 Express Chipset ; I/O Controller Hub 7 (ICH7) for SATA 3.0Gb/s, ATA-100 EIDE, PCI Express ⁹ x1, PCI 2.3, USB, LPC bus / ITE Tech [®] IT8718 Super I/O for serial, parallel, keyboard, mouse functions										Security <ul style="list-style-type: none"> • One lock to secure both cover and entire system to fixed object: <ul style="list-style-type: none"> - Padlock loop (in rear for opt padlock) - Security slot (in rear for optional Kensington[®] Microsaver[®] cable) • Power-on password • Administrator password • Hard disk password • Boot sequence control • Boot without keyboard, mouse, diskette • Serial port I/O control • Parallel port I/O control • USB port disablement 		
Front ports	Two USB 2.0, microphone (stereo, 3.5mm), headphone (stereo, 3.5mm)												
Rear ports	Four USB 2.0, serial (9-pin), parallel (25-pin), keyboard (PS/2), mouse (PS/2), ethernet (RJ-45), monitor (VGA DB-15)												
Internal connector	Two USB 2.0 planar connectors (one used; one open for media reader)												
Rear audio ports	Line-in (stereo, 3.5mm), line-out (stereo, 3.5mm), microphone (stereo, 3.5mm)												
Audio	High Definition (HD) Audio, Realtek [®] ALC662 codec												
Speaker	One internal speaker for business audio												
Ethernet	Gigabit ethernet on planar, Marvell [®] 88E8056, PCIe x1, Wake on LAN [®]												
Intel AMT	None												
Modem	None												
Security chip	None												
Keyboard	Preferred Pro USB Keyboard (USB connector), 104-key, black, Lenovo logo												
Mouse	Optical Wheel Mouse (USB connector), 400 dpi, black, Lenovo logo												
Power supply	280 watts with variable speed fan, manual switch												
Preloaded operating system²⁰	- Microsoft [®] Windows [®] Vista [®] Business Edition (32-bit) ♦ Vista Basic logo										Supports ThinkVantage [®] technologies		
Preloaded applications⁵	<ul style="list-style-type: none"> • Rescue and Recovery[™] • Client Security Solution[™] • ThinkVantage Productivity Center • ThinkVantage System Update • System Migration Assistant • Norton Internet Security[™] (90 days of virus definitions) • Diskeeper[®] Home • PC-Doctor[™] (diagnostics) • Adobe[®] Reader • Windows Live[™] Toolbar • Windows Live Search • Picasa from Google • Microsoft Office 2007 Trial (60-day) • Sonic RecordNow and Drive Letter Access (combo) • Corel[®] WinDVD[®] (combo) 										RoHS-compliant		
Accessories	<ul style="list-style-type: none"> 1GB PC2-5300 CL5 NP DDR2 UDIMM 73P4984 2GB PC2-5300 CL5 NP DDR2 UDIMM 73P4985 1GB PC2-6400 NP DDR2 UDIMM 41U2977 2GB PC2-6400 NP DDR2 UDIMM 41U2978 250GB SATA 3.0Gb/s Disk (7200 rpm) 41N3015 500GB SATA 3.0Gb/s Disk (7200 rpm) 43R1990 USB Portable Diskette Drive 05K9276 USB 2.0 Lenovo Multimedia Headset 40Y8518 USB 2.0 Lenovo Webcam 40Y8519 USB 2.0 Essential Memory Key 32GB 45K1258 USB 2.0 Ultra Secure Memory Key 8GB 45J5918 USB 2.0 Portable Secure 320GB Hard Disk 43R2019 Super Multi-Burner DL DVD±RW SATA Drive 41N5620 ThinkVision[™] L2240p Wide 22" Monitor 4422HB6 ThinkVision L2440p Wide 24" Monitor 4420HB2 Wireless Kbd & Opt Wheel Mouse (via USB) 73P4067 Laser Tilt Wheel Mouse (USB, PS/2) 41U3074 Kensington Cable Lock from Lenovo 73P2582 ADD2 DVI-I PCIe Connection Adapter 73P2516 ADD2 DVI-D Monitor Connection (HDCP) 43R1985 ATI[™] Radeon[™] HD 2400 Pro 128MB 43R1961 ATI Radeon HD 2400 XT 256MB 43R1962 ATI Radeon HD 2600 XT 512MB 43R1963 NVIDIA[®] Quadro[®] 256MB NVS 290 43R1765 NVIDIA Quadro 256MB FX 370 43R1766 NVIDIA Quadro 512MB FX 1700 43R1767 Acc Guide in pdf lenovo.com/accessoriesguide Other accessories at lenovo.com/accessories 										Limited Warranty¹ <ul style="list-style-type: none"> ↔ 3-year parts and labor ↔ International Warranty Service⁹ ↔ Customer Replaceable Unit (CRU) parts only (with limited onsite service for selected parts³, 8 am - 5 pm, Mon - Fri coverage excluding holidays, next business day response time) ↔ Onsite service upgrade options (in eligible locations):⁷ <ul style="list-style-type: none"> • 4-year LOR 9x5, Next Business Day (ThinkPlus part number 41C9194) • 4-year LOR 9x5, 4 hour response (ThinkPlus part number 41C9195) • 4-year LOR 24x7, 4 hour response (ThinkPlus part number 41C9196) ↔ ThinkPlus services at lenovo.com/thinkplus/warranty ↔ Post warranty maintenance services available ↔ 24 hour x 7 day¹⁴ toll-free support during the warranty period¹ via 800-426-7378 		

See footnotes for important warranty information
US model announced March 18, 2008

Partial list of accessories supported on ThinkCentre M57e

Memory

512MB PC2-5300 CL5 NP DDR2 UDIMM	73P4983	ann 06/28/05
1GB PC2-5300 CL5 NP DDR2 UDIMM	73P4984	ann 06/28/05
2GB PC2-5300 CL5 NP DDR2 UDIMM	73P4985	ann 09/26/06
512MB PC2-6400 NP DDR2 UDIMM ⁴⁸	41U2976	ann 09/26/06
1GB PC2-6400 NP DDR2 UDIMM ⁴⁸	41U2977	ann 09/26/06
2GB PC2-6400 NP DDR2 UDIMM ⁴⁸	41U2978	ann 01/08/08

⁴⁸ When PC2-6400 is installed with systems that have PC2-5300 memory, PC2-6400 will operate at the PC2-5300 memory speed.

Optical

DVD-ROM DL SATA 1.5Gb/s 16X-48X Max ⁴	41N5618	ann 09/26/06
Super Multi-Burner DL DVD±RW SATA Drive	41N5620	ann 09/26/06

Storage and removable storage

80GB SATA 3.0Gb/s Disk (7200 rpm)	09N4253	ann 05/19/03
160GB SATA 3.0Gb/s Disk (7200 rpm)	09N4254	ann 05/19/03
250GB SATA 3.0Gb/s Disk (7200 rpm)	41N3015	ann 01/24/06
500GB SATA 3.0Gb/s Disk (7200 rpm)	43R1990	ann 11/06/07

USB Portable Diskette Drive	05K9276	ann 06/05/00
USB 2.0 Essential Memory Key 1GB	41U4940	ann 01/23/07
USB 2.0 Essential Memory Key 2GB	41U4944	ann 01/23/07
USB 2.0 Essential Memory Key 4GB	45J7904	ann 06/24/08
USB 2.0 Essential Memory Key 8GB	45J7905	ann 07/15/08
USB 2.0 Essential Memory Key 32GB	45K1258	ann 10/28/08
USB 2.0 Security Memory Key 1GB	41U5118	ann 07/17/07
USB 2.0 Security Memory Key 2GB	41U5119	ann 07/17/07
USB 2.0 Security Memory Key 4GB	41U5120	ann 07/17/07
USB 2.0 Ultra Secure Memory Key 1GB	45J5915	ann 08/26/08
USB 2.0 Ultra Secure Memory Key 2GB	45J5916	ann 08/26/08
USB 2.0 Ultra Secure Memory Key 4GB	45J5917	ann 08/26/08
USB 2.0 Ultra Secure Memory Key 8GB	45J5918	ann 08/26/08
USB 2.0 Portable 160GB Hard Disk	43R1784	ann 09/23/08
USB 2.0 Portable Secure 160GB Hard Disk	43R2018	ann 11/18/08
USB 2.0 Portable Secure 320GB Hard Disk	43R2019	ann 11/18/08
USB 2.0 CD-RW/DVD-ROM Combo II Drive	40Y8637	ann 01/05/06
USB 2.0 Super Multi-Burner Drive	41N5565	ann 01/23/07

Graphics

Small 6305/9482/9487/6178/7066 support Low Profile 35 watts max:

ADD2 DVI-I PCIe Connection Adapter	73P2516	ann 06/28/05
ADD2 DVI-D Monitor Connection (HDCP)	43R1985	ann 11/06/07
ATI™ Radeon™ HD 2400 Pro 128MB	43R1961	ann 11/06/07
ATI Radeon HD 2400 XT 256MB	43R1962	ann 11/06/07

Desktop 9481/9438/6177/7065 support Low Profile 35 watts max:

ADD2 DVI-I PCIe Connection Adapter	73P2516	ann 06/28/05
ADD2 DVI-D Monitor Connection (HDCP)	43R1985	ann 11/06/07
ATI Radeon HD 2400 Pro 128MB	43R1961	ann 11/06/07
ATI Radeon HD 2400 XT 256MB	43R1962	ann 11/06/07
NVIDIA® Quadro® 256MB NVS 290	43R1765	ann 12/18/07

Tower 6179/9439/9356/6176/7064 support 75 watts max:

ADD2 DVI-I PCIe Connection Adapter	73P2516	ann 06/28/05
ADD2 DVI-D Monitor Connection (HDCP)	43R1985	ann 11/06/07
ATI Radeon HD 2400 Pro 128MB	43R1961	ann 11/06/07
ATI Radeon HD 2400 XT 256MB	43R1962	ann 11/06/07
ATI Radeon HD 2600 XT 512MB	43R1963	ann 11/06/07
NVIDIA Quadro 256MB NVS 290	43R1765	ann 12/18/07
NVIDIA Quadro 256MB FX 370	43R1766	ann 12/18/07
NVIDIA Quadro 512MB FX 1700	43R1767	ann 12/18/07

More information at www.lenovo.com/support/graphiccards

Keyboard

Preferred Pro USB Keyboard	73P5220	ann 06/21/05
Preferred Pro Full Size PS/2 Keyboard	31P7415	ann 06/04/02
Enhanced Performance USB Keyboard	73P2620	ann 03/23/04
Wireless Kbd & Opt Wheel Mouse (via USB)	73P4067	ann 12/07/04
Lenovo USB Fingerprint Keyboard	73P4730	ann 02/22/05

More information at www.lenovo.com/support/keyboards

Mouse

Optical Wheel Mouse (USB)	06P4069	ann 05/21/03
Optical ScrollPoint® Mouse (USB, PS/2)	31P7405	ann 08/27/02
Laser Tiit Wheel Mouse (USB, PS/2)	41U3074	ann 01/23/07
Lenovo Wireless Laser Mouse (blk, via USB)	45K1696	ann 11/25/08
Lenovo Wireless Laser Mouse (red, via USB)	51J0198	ann 11/25/08

More information at www.lenovo.com/support/mice

Multimedia

USB 2.0 Lenovo Multimedia Headset	40Y8518	ann 06/27/06
USB 2.0 Lenovo Webcam	40Y8519	ann 08/29/06

Security

Kensington® Cable Lock from Lenovo	73P2582	ann 12/29/03
Kensington Twin Head Cable Lock	45K1620	ann 09/30/08
USB Gemplus GemPC Smart Card Reader	41N3040	ann 02/21/06

Monitors

ThinkVision® L174 17" Monitor	9227AE1	ann 04/15/08
ThinkVision L1700p 17" Monitor	9417HE2	ann 09/17/08
ThinkVision L1900p 19" Monitor	4431HE1	ann 11/11/08
ThinkVision L1940p Wide 19" Monitor	4424HB6	ann 09/17/08
ThinkVision L200p Wide 20.1" Monitor	4438HB6	ann 04/15/08
ThinkVision L2240p Wide 22" Monitor	4422HB6	ann 09/17/08
ThinkVision L2440p Wide 24" Monitor	4420HB2	ann 09/17/08
ThinkVision L2440x Wide 24" Monitor	4421HB2	ann 09/17/08

More information at www.lenovo.com/thinkvision

Monitor Accessories⁴⁶

ThinkVision USB Soundbar	40Y7616	ann 08/23/05
ThinkVision Soundbar (L1900p, 24" Wide)	45K1263	ann 09/16/08
Kensington Cable Lock from Lenovo	73P2582	ann 12/29/03
Kensington Twin Head Cable Lock	45K1620	ann 09/30/08
Radial Arm	19K4464	ann 05/05/00

⁴⁶Compatible on selected Lenovo and ThinkVision monitors.

More information at www.lenovo.com/support/monitoraccessories

Medialess License Key (MLK)

Microsoft® Office 2007 Basic, English	43R1528	ann 01/31/07
Microsoft Office 2007 Small Business, Engl	43R1534	ann 01/31/07
Microsoft Office 2007 Professional, English	43R1531	ann 01/31/07

Other accessories at www.lenovo.com/accessories

Accessories Guide pdf at www.lenovo.com/accessoriesguide



Lenovo ThinkCentre M57
with Lenovo widescreen monitor



Lenovo ThinkCentre M57p
with ThinkVision L190x monitor



Lenovo ThinkCentre M57



Lenovo ThinkCentre M57p



Lenovo ThinkCentre M57
and ThinkVision monitor on
Lenovo Vertical PC and Monitor Stand (41R4359)



Lenovo ThinkCentre M57p
and ThinkVision monitor on
Lenovo Vertical PC and Monitor Stand (41R4359)

ThinkCentre® M57 Eco Ultra Small (6395)

Personal Systems Reference (PSREF)

Name	Type-model	Slot x bay	Processor	GHz	L2 cache	Memory ⁸	SATA disk	SATA optical	Graphics	DVI-D conn	Intel vPro	Serial port	Vista preload	Limited warranty ¹	Global Educ	Avail date
ES	M57	6395-61U	0x2 Celeron 440	2.00	512KB	1GB	160GB ²	DVD	GMA	DVI-D	None		Business32	3-yr		Jun 08
ES	M57	6395-62U	0x2 Pentium E2160	1.80	1MB	1GB	160GB	DVD	GMA	DVI-D	None		Business32	3-yr	Educ	Jun 08
	M57	6395-17U	0x2 Core 2 Duo E4500	2.20	2MB	1GB	160GB	DVD	GMA	DVI-D	None		Business32	3-yr		Feb 08
	M57	6395-23U	0x2 Core 2 Duo E8200	2.66	6MB	2GB	160GB	DVD±RW	GMA	DVI-D	None		Business32	3-yr	Gbl	Feb 08
	M57	6395-24U	0x2 Core 2 Duo E8200	2.66	6MB	2GB	160GB	DVD±RW	GMA	DVI-D	None	Serial	Business32	3-yr		Feb 08

- Only 4.5 liter volume (25% less than the 6.3 liter ThinkCentre M57 Ultra Small)
- Best acoustic and lowest power consumption of all Lenovo desktops

Positioning Processor	<p><i>Ultimate enterprise stability for large enterprise and mid-market</i></p> <p>Intel® Celeron® Processor 440 with single-core, Intel 64 Tech, Execute Disable Bit, 800MHz system bus, and 512KB L2 cache or Intel Pentium® Dual-Core Processor E2160 with dual-core, Intel 64 Technology, Execute Disable Bit, EIST, 800MHz system bus, and 1MB shared L2 cache or Intel Core™ 2 Duo Processor E4500 with dual-core, Intel 64 Technology, Execute Disable Bit, EIST, 800MHz system bus, and 2MB shared L2 cache or Intel Core 2 Duo Processor E8200 with dual-core, Intel 64 Technology, Virtualization Technology, Execute Disable Bit, EIST, TXT, and 1333MHz system bus with 6MB shared L2 cache Processor in FC-LGA6 or FC-LGA8 package in LGA775 socket</p>	<p>Eco Ultra Small</p>  <p>Bay ① 5.25", 1.6" high, access, std optical Bay ② 3.5", 1" high, no access, std disk Slots: None</p> <ul style="list-style-type: none"> • Business black color; metal case • 10.8" W X 9.5" D X 3.2" H • 275mm W X 242mm D X 81mm H • 7.2 to 8.2lb (3.3 to 3.7kg) • Toolless disk and optical drive removal • Hinged toolless cover for easy serviceability • Steel chassis supports 110 lb (50kg) monitor on top • Supports Vertical PC and Monitor Stand (41R4359) 																																								
Implementation																																										
Memory	<p>1GB or 2GB std, 4GB max⁸, PC2-5300 667MHz DDR2, non-parity, dual-channel capable, two 200-pin SODIMM sockets (notebook); <i>Non-italics</i>: standard memory in one socket; one socket available</p>																																									
Graphics	<p>Intel Graphics Media Accelerator 3100 (GMA 3100), integrated graphics in Q35, uses main memory (up to 256MB), one analog VGA DB-15 connector, one DVI-D connector, supports dual independent display</p>	<p>Security</p> <ul style="list-style-type: none"> • Security chip (see information on left) • Security slot (in rear for attachment of optional Kensington® Microsaver® cable) - optional cable also locks the cover by deactivating the cover release buttons • Power-on password • Administrator password • Hard disk password • Boot sequence control • Boot without keyboard, mouse • Individual USB port disablement • Chassis intrusion switch • <i>Some</i>: Serial port disablement 																																								
SATA disk	<p>160GB, SATA 3.0Gb/s 7200 rpm, vibration dampening mounts</p>																																									
SATA controller	<p>Serial ATA, SATA 3.0Gb/s, integrated in ICH9</p>																																									
SATA DVD	<p><i>Some</i>: DVD-ROM DL SATA 1.5Gb/s 16-48X Max⁴ Drive (41N5618)</p>																																									
SATA DVD±RW	<p><i>Some</i>: Super Multi-Burner DL DVD±RW SATA 1.5Gb/s Drive (41N5620)</p>																																									
SATA cables	<p>Two SATA cables (each 1-drop to device), two SATA connectors on planar</p>																																									
eSATA port	<p>None</p>																																									
EIDE controller	<p>None</p>																																									
Diskette drive	<p>None</p>																																									
Media reader	<p>None</p>																																									
Chipset	<p>Intel Q35 Express Chipset; I/O Controller Hub 9 (ICH9) for SATA 3.0Gb/s, PCI Express® x1, ethernet (MAC), PCI 2.3, USB, LPC bus / SMSC® SCH5617 Super I/O for [serial], hardware monitoring (temperature, voltage, fan speed)</p>																																									
Front ports	<p>Two USB 2.0, microphone (stereo, 3.5mm), headphone (stereo, 3.5mm)</p>																																									
Rear ports	<p>Four USB 2.0, ethernet (RJ-45), monitor (VGA DB-15, DVI-D), <i>Some</i>: serial (9-pin)</p>																																									
Rear audio ports	<p>Line-in (stereo, 3.5mm), line-out (stereo, 3.5mm), microphone (stereo, 3.5mm)</p>																																									
Audio	<p>High Definition (HD) Audio, Analog Devices AD1882 codec</p>																																									
Speaker	<p>One internal speaker for business audio</p>																																									
Ethernet	<p>Gigabit ethernet on planar, Intel 82566DM (PHY/MAC), PCIe x1, ASF 2.0</p>																																									
Intel AMT	<p>None</p>																																									
Modem	<p>None</p>																																									
Security chip	<p>Winbond® WPCT200 SafeKeeper™ Trusted Platform Module, TCG 1.2-compliant</p>																																									
Keyboard	<p>Preferred Pro USB Keyboard (USB connector), 104-key, black, Lenovo logo</p>																																									
Mouse	<p>Optical Wheel Mouse (USB connector), black, Lenovo logo</p>																																									
Power supply	<p>External AC/DC adapter, 120 watts, autosensing, 85% PSU</p>																																									
Preloaded operating system²⁰	<p>- Microsoft® Windows® Vista® Business Edition (32-bit) ◇ Vista Basic logo</p>																																									
Preloaded applications⁵ (only some listed)	<ul style="list-style-type: none"> • <i>Some</i>: Education software - VitalSource Library College Edition - Adobe® Instructor Resource Center - Adobe Digital School Collection - Photoshop Elements 6 (and CD) - Premier Elements 4 (and DVD) - Acrobat 8 Professional (and CD) - Contribute 4 (and CD) • Rescue and Recovery™ • Client Security Solution™ • ThinkVantage Productivity Center • System Migration Assistant • Norton Internet Security™ • Microsoft Office 2007 Trial (60-day) • Sonic RecordNow and Drive Letter Access (DVD±RW) • Corel® WinDVD® (DVD, DVD±RW) 	<p>Accessories</p> <table border="0"> <tr> <td>1GB PC2-5300 DDR2 SODIMM (notebook)</td> <td>43R1763</td> </tr> <tr> <td>2GB PC2-5300 DDR2 SODIMM (notebook)</td> <td>43R1756</td> </tr> <tr> <td>500GB SATA 3.0Gb/s Disk (7200 rpm)</td> <td>43R1990</td> </tr> <tr> <td>1TB SATA 3.0Gb/s Disk (7200 rpm)</td> <td>45J7918</td> </tr> <tr> <td>USB Portable Diskette Drive</td> <td>05K9276</td> </tr> <tr> <td>USB 2.0 Lenovo Multimedia Headset</td> <td>40Y8518</td> </tr> <tr> <td>USB 2.0 Lenovo Webcam</td> <td>40Y8519</td> </tr> <tr> <td>USB 2.0 Essential Memory Key 32GB</td> <td>45K1258</td> </tr> <tr> <td>USB 2.0 Ultra Secure Memory Key 8GB</td> <td>45J5918</td> </tr> <tr> <td>USB 2.0 Portable Secure 320GB Hard Disk</td> <td>43R2019</td> </tr> <tr> <td>USB 2.0 Super Multi-Burner Drive</td> <td>41N5565</td> </tr> <tr> <td>ThinkVision® L1940p Wide 19" Monitor</td> <td>4424HB6</td> </tr> <tr> <td>ThinkVision L2240p Wide 22" Monitor</td> <td>4422HB6</td> </tr> <tr> <td>ThinkVision L2440p Wide 24" Monitor</td> <td>4420HB2</td> </tr> <tr> <td>ThinkCentre Ultra Small Under Desk Mount</td> <td>40Y8625</td> </tr> <tr> <td>Lenovo Vertical PC and Monitor Stand</td> <td>41R4359</td> </tr> <tr> <td>Wireless Kbd & Opt Wheel Mouse (via USB)</td> <td>73P4067</td> </tr> <tr> <td>USB Travel Keyboard with UltraNav™</td> <td>31P9490</td> </tr> <tr> <td>Laser Tilt Wheel Mouse (USB, PS/2)</td> <td>41U3074</td> </tr> <tr> <td>Kensington Cable Lock from Lenovo</td> <td>73P2582</td> </tr> </table> <p>Other accessories at lenovo.com/accessories</p>	1GB PC2-5300 DDR2 SODIMM (notebook)	43R1763	2GB PC2-5300 DDR2 SODIMM (notebook)	43R1756	500GB SATA 3.0Gb/s Disk (7200 rpm)	43R1990	1TB SATA 3.0Gb/s Disk (7200 rpm)	45J7918	USB Portable Diskette Drive	05K9276	USB 2.0 Lenovo Multimedia Headset	40Y8518	USB 2.0 Lenovo Webcam	40Y8519	USB 2.0 Essential Memory Key 32GB	45K1258	USB 2.0 Ultra Secure Memory Key 8GB	45J5918	USB 2.0 Portable Secure 320GB Hard Disk	43R2019	USB 2.0 Super Multi-Burner Drive	41N5565	ThinkVision® L1940p Wide 19" Monitor	4424HB6	ThinkVision L2240p Wide 22" Monitor	4422HB6	ThinkVision L2440p Wide 24" Monitor	4420HB2	ThinkCentre Ultra Small Under Desk Mount	40Y8625	Lenovo Vertical PC and Monitor Stand	41R4359	Wireless Kbd & Opt Wheel Mouse (via USB)	73P4067	USB Travel Keyboard with UltraNav™	31P9490	Laser Tilt Wheel Mouse (USB, PS/2)	41U3074	Kensington Cable Lock from Lenovo	73P2582
1GB PC2-5300 DDR2 SODIMM (notebook)	43R1763																																									
2GB PC2-5300 DDR2 SODIMM (notebook)	43R1756																																									
500GB SATA 3.0Gb/s Disk (7200 rpm)	43R1990																																									
1TB SATA 3.0Gb/s Disk (7200 rpm)	45J7918																																									
USB Portable Diskette Drive	05K9276																																									
USB 2.0 Lenovo Multimedia Headset	40Y8518																																									
USB 2.0 Lenovo Webcam	40Y8519																																									
USB 2.0 Essential Memory Key 32GB	45K1258																																									
USB 2.0 Ultra Secure Memory Key 8GB	45J5918																																									
USB 2.0 Portable Secure 320GB Hard Disk	43R2019																																									
USB 2.0 Super Multi-Burner Drive	41N5565																																									
ThinkVision® L1940p Wide 19" Monitor	4424HB6																																									
ThinkVision L2240p Wide 22" Monitor	4422HB6																																									
ThinkVision L2440p Wide 24" Monitor	4420HB2																																									
ThinkCentre Ultra Small Under Desk Mount	40Y8625																																									
Lenovo Vertical PC and Monitor Stand	41R4359																																									
Wireless Kbd & Opt Wheel Mouse (via USB)	73P4067																																									
USB Travel Keyboard with UltraNav™	31P9490																																									
Laser Tilt Wheel Mouse (USB, PS/2)	41U3074																																									
Kensington Cable Lock from Lenovo	73P2582																																									
		<p>Supports ThinkVantage® technologies</p> <p>EPEAT™ Gold rating ENERGY STAR® 4.0-compliant GREENGUARD® certified RoHS-compliant</p> <p>Limited Warranty¹</p> <ul style="list-style-type: none"> ↪ 3-year parts and labor ↪ International Warranty Service⁹ ↪ Customer Replaceable Unit (CRU) parts only (with limited onsite service for selected parts³, 8 am - 5 pm, Mon - Fri coverage excluding holidays, next business day response time) ↪ Onsite service upgrade options (in eligible locations):⁷ <ul style="list-style-type: none"> • 3-year LOR 9x5, 4 hour response (ThinkPlus™ part number 41C9192) • 3-year LOR 24x7, 4 hour response (ThinkPlus part number 41C9193) • 4-year LOR 9x5, Next Business Day (ThinkPlus part number 41C9194) • 4-year LOR 9x5, 4 hour response (ThinkPlus part number 41C9195) • 4-year LOR 24x7, 4 hour response (ThinkPlus part number 41C9196) ↪ ThinkPlus services at lenovo.com/thinkplus/warranty ↪ Post warranty maintenance services available ↪ 24 hour x 7 day¹⁴ toll-free support during the warranty period¹ via 800-426-7378 																																								

See footnotes for important warranty information
ES US models announced May 20, 2008; previous models on February 12, 2008

ThinkCentre® M57 Eco Ultra Small (6395) - August 2008

Personal Systems Reference (PSREF)

Name	Type-model	Slot x bay	Processor	GHz	L2 cache	Memory ⁵	SATA disk	SATA optical	Graphics	DVI-D conn	Intel vPro	Card slot	Serial port	Preload	Global Educ	Avail date
M57	6395-84U	0x2	Pentium E2200	2.20	1MB	1GB	160GB ²	DVD	GMA	DVI-D	None		Serial	XP Pro	None	Sep 08
M57	6395-85U	0x2	Pentium E2200	2.20	1MB	2GB	250GB	DVD±RW	GMA	DVI-D	None	/54	Serial	XP Pro	None	Sep 08
M57	6395-82U	0x2	Core 2 Duo E7200	2.53	3MB	1GB	160GB	DVD	GMA	DVI-D	None		Serial	XP Pro	None	Sep 08
M57	6395-83U	0x2	Core 2 Duo E7200	2.53	3MB	2GB	250GB	DVD±RW	GMA	DVI-D	None	/54	Serial	XP Pro	None	Sep 08
M57	6395-88U	0x2	Core 2 Duo E8200	2.66	6MB	1GB	160GB	DVD	GMA	DVI-D	None		Serial	XP Pro	None	Sep 08
M57	6395-89U	0x2	Core 2 Duo E8200	2.66	6MB	2GB	160GB	DVD±RW	GMA	DVI-D	None	/54	Serial	XP Pro	None	Sep 08
M57	6395-86U	0x2	Core 2 Duo E8400	3.00	6MB	1GB	160GB	DVD	GMA	DVI-D	None		Serial	XP Pro	None	Sep 08
M57	6395-87U	0x2	Core 2 Duo E8400	3.00	6MB	2GB	160GB	DVD±RW	GMA	DVI-D	None	/54	Serial	XP Pro	None	Sep 08

- Only 4.5 liter volume (25% less than the 6.3 liter ThinkCentre M57 Ultra Small)
- Best acoustic and lowest power consumption of all Lenovo desktops
- These models have a 3-year limited warranty¹

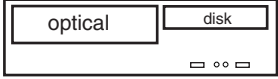
Positioning Processor	<p><i>Ultimate enterprise stability for large enterprise and mid-market</i></p> <p>Intel® Pentium® Dual-Core Processor E2200 with dual-core, Intel 64 Technology, Execute Disable Bit, EIST, 800MHz system bus, and 1MB shared L2 cache or Intel Core™ 2 Duo Processor E7200 with dual-core, Intel 64 Technology, Execute Disable Bit, EIST, 1066MHz system bus, and 3MB shared L2 cache or Intel Core 2 Duo Processor E8200 or E8400 with dual-core, Intel 64 Technology, Virtualization Technology, Execute Disable Bit, EIST, TXT, and 1333MHz system bus with 6MB shared L2 cache Processor in FC-LGA6 or FC-LGA8 package in LGA775 socket</p>	<p>Eco Ultra Small</p>  <p>Bay ① 5.25", 1.6" high, access, std optical Bay ② 3.5", 1" high, no access, std disk</p> <p>Slots: None</p> <ul style="list-style-type: none"> • Business black color; metal case • 10.8" W X 9.5" D X 3.2" H • 275mm W X 242mm D X 81mm H • 7.2 to 8.2lb (3.3 to 3.7kg) • Toolless disk and optical drive removal • Hinged toolless cover for easy serviceability • Steel chassis supports 110 lb (50kg) monitor on top • Supports Vertical PC and Monitor Stand (41R4359)
Implementation		
Memory	<p>1GB or 2GB std, 4GB max⁸, PC2-5300 667MHz DDR2, non-parity, dual-channel capable, two 200-pin SODIMM sockets (notebook); <i>Italics:</i> standard memory in both sockets; no sockets avail; <i>Non-italics:</i> standard memory in one socket; one socket available</p>	
Graphics	<p>Intel Graphics Media Accelerator 3100 (GMA 3100), integrated graphics in Q35, uses main memory (up to 256MB), one analog VGA DB-15 connector, one DVI-D connector, supports dual independent display</p>	<p>Security</p> <ul style="list-style-type: none"> • Security chip (see information on left) • Security slot (in rear for attachment of optional Kensington® Microsaver® cable) - optional cable also locks the cover by deactivating the cover release buttons • Power-on password • Administrator password • Hard disk password • Boot sequence control • Boot without keyboard, mouse • Individual USB port disablement • <i>Some:</i> Serial port disablement
SATA disk	<p>160GB or 250GB, SATA 3.0Gb/s 7200 rpm, vibration dampening mounts</p>	
SATA controller	<p>Serial ATA, SATA 3.0Gb/s, integrated in ICH9</p>	
SATA DVD	<p><i>Some:</i> DVD-ROM DL SATA 1.5Gb/s 16-48X Max⁴ Drive (41N5618)</p>	
SATA DVD±RW	<p><i>Some:</i> Super Multi-Burner DL DVD±RW SATA 1.5Gb/s Drive (41N5620)</p>	
SATA cables	<p>Two SATA cables (each 1-drop to device), two SATA connectors on planar</p>	
eSATA port	<p>None</p>	
EIDE controller	<p>None</p>	
Diskette drive	<p>None</p>	
Media reader	<p>None</p>	
Chipset	<p>Intel Q35 Express Chipset: I/O Controller Hub 9 (ICH9) for SATA 3.0Gb/s, PCI Express® x1, ethernet (MAC), PCI 2.3, USB, LPC bus / SMSC® SCH5617 Super I/O for [serial], hardware monitoring (temperature, voltage, fan speed)</p>	
Front ports	<p>Two USB 2.0, microphone (stereo, 3.5mm), headphone (stereo, 3.5mm)</p>	
Rear ports	<p>Four USB 2.0, ethernet (RJ-45), monitor (VGA DB-15, DVI-D), <i>Some:</i> serial (9-pin)</p>	<p>Supports ThinkVantage® technologies</p>
ExpressCard/54	<p><i>Some:</i> One slot (ExpressCard/34, ExpressCard/54)</p>	
Rear audio ports	<p>Line-in (stereo, 3.5mm), line-out (stereo, 3.5mm), microphone (stereo, 3.5mm)</p>	
Audio	<p>High Definition (HD) Audio, Analog Devices AD1882 codec</p>	
Speaker	<p>One internal speaker for business audio</p>	
Ethernet	<p>Gigabit ethernet on planar, Intel 82566DM (PHY/MAC), PCIe x1, ASF 2.0</p>	
Intel AMT	<p>None</p>	
Modem	<p>None</p>	
Security chip	<p>Winbond® WPCT200 SafeKeeper™ Trusted Platform Module, TCG 1.2-compliant</p>	<p>EPEAT™ Gold rating ENERGY STAR® 4.0-compliant GREENGUARD® certified RoHS-compliant</p>
Keyboard	<p>Preferred Pro USB Keyboard (USB connector), 104-key, black, Lenovo logo</p>	
Mouse	<p>Optical Wheel Mouse (USB connector), black, Lenovo logo</p>	
Power supply	<p>External AC/DC adapter, 120 watts, autosensing, 85% PSU</p>	
Preloaded operating system²⁰	<p>- Microsoft® Windows® XP Professional with Vista® COA ♦ Disk-to-Disk Recovery (in hidden protected area)</p>	
Preloaded applications⁵ (only some listed)	<ul style="list-style-type: none"> • Rescue and Recovery™ • Client Security Solution™ • ThinkVantage Productivity Center • ThinkVantage System Update • Norton Internet Security™ • Diskeeper® Home • Microsoft Office 2007 Trial (60-day) • Multimedia Center for Think Offerings (DVD, DVD±RW) • Sonic RecordNow and Drive Letter Access (DVD±RW) • Corel® WinDVD® (DVD, DVD±RW) • Corel WinDVD Creator (DVD±RW) 	<p>Accessories</p> <ul style="list-style-type: none"> 1GB PC2-5300 DDR2 SODIMM (notebook) 43R1763 2GB PC2-5300 DDR2 SODIMM (notebook) 43R1756 500GB SATA 3.0Gb/s Disk (7200 rpm) 43R1990 1TB SATA 3.0Gb/s Disk (7200 rpm) 45J7918 USB Portable Diskette Drive 05K9276 USB 2.0 Lenovo Multimedia Headset 40Y8518 USB 2.0 Lenovo Webcam 40Y8519 USB 2.0 Ultra Secure Memory Key 8GB 45J5918 USB 2.0 Portable Secure 320GB Hard Disk 43R2019 ThinkVision® L2240p Wide 22" Monitor 4422HB6 ThinkVision L2440p Wide 24" Monitor 4420HB2 ThinkCentre Ultra Small Under Desk Mount 40Y8625 Lenovo Vertical PC and Monitor Stand 41R4359 Wireless Kbd & Opt Wheel Mouse (via USB) 73P4067 USB Travel Keyboard with UltraNav™ 31P9490 Laser Tilt Wheel Mouse (USB, PS/2) 41U3074 Kensington Cable Lock from Lenovo 73P2582 Other accessories at lenovo.com/accessories
		<p>↪ 3-year parts and labor</p> <p>↪ International Warranty Service⁹</p> <p>↪ Customer Replaceable Unit (CRU) parts only (with limited onsite service for selected parts³, 8 am - 5 pm, Mon - Fri coverage excluding holidays, next business day response time)</p> <p>↪ Onsite service upgrade options (in eligible locations):⁷</p> <ul style="list-style-type: none"> • 3-year LOR 9x5, 4 hour response (ThinkPlus™ part number 41C9192) • 3-year LOR 24x7, 4 hour response (ThinkPlus part number 41C9193) • 4-year LOR 9x5, Next Business Day (ThinkPlus part number 41C9194) • 4-year LOR 9x5, 4 hour response (ThinkPlus part number 41C9195) • 4-year LOR 24x7, 4 hour response (ThinkPlus part number 41C9196) <p>↪ ThinkPlus services at lenovo.com/thinkplus/warranty</p> <p>↪ Post warranty maintenance services available</p> <p>↪ 24 hour x 7 day¹⁴ toll-free support during the warranty period¹ via 800-426-7378</p>

See footnotes for important warranty information
US models announced August 19, 2008

© Lenovo
(BLLF1-4) September 2008

ThinkCentre® M57p Eco Ultra Small (6395)

Personal Systems Reference (PSREF)

Name	Type-model	Slot x bay	Processor	GHz	L2 cache	Memory ⁸	SATA disk	SATA optical	Graphics	DVI-D conn	Intel vPro	Serial port	Vista preload	Limited warranty ¹	Global Educ	Avail date
M57p	6395-36U	0x2	Core 2 Duo E8200	2.66	6MB	2GB	160GB ²	DVD±RW	GMA	DVI-D	vPro		Business32	3-yr	Gbl	Feb 08
M57p	6395-37U	0x2	Core 2 Duo E8200	2.66	6MB	2GB	160GB	DVD±RW	GMA	DVI-D	vPro	Serial	Business32	3-yr		Feb 08
M57p	6395-26U	0x2	Core 2 Duo E8400	3.00	6MB	1GB	320GB	DVD±RW	GMA	DVI-D	vPro		Business32	3-yr		Feb 08
M57p	6395-27U	0x2	Core 2 Duo E8400	3.00	6MB	2GB	160GB	DVD	GMA	DVI-D	vPro		Business32	3-yr		Feb 08
M57p	6395-28U	0x2	Core 2 Duo E8400	3.00	6MB	2GB	160GB	DVD	GMA	DVI-D	vPro	Serial	Business32	3-yr		Feb 08
M57p	6395-29U	0x2	Core 2 Duo E8400	3.00	6MB	2GB	160GB	DVD±RW	GMA	DVI-D	vPro		Business32	3-yr	Gbl	Feb 08
M57p	6395-31U	0x2	Core 2 Duo E8400	3.00	6MB	2GB	160GB	DVD±RW	GMA	DVI-D	vPro		Business32	3-yr	HE	Feb 08

- **Intel Core 2 Processor with vPro™ Technology (includes Intel Active Management Technology)**
- **Only 4.5 liter volume (25% less than the 6.3 liter ThinkCentre M57 Ultra Small)**
- **Best acoustic and lowest power consumption of all Lenovo desktops**

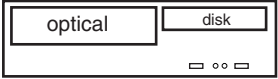
Positioning Processor	Ultimate enterprise stability and manageability for large enterprise Intel® Core™ 2 Duo Processor E8200 or E8400 with dual-core, dual-channel capable, two 200-pin SODIMM sockets (notebook); EIST, TXT, and 1333MHz system bus with 6MB shared L2 cache Processor in FC-LGA8 package in LGA775 socket	Eco Ultra Small	
Implementation	Processor in FC-LGA8 package in LGA775 socket		
Memory	1GB or 2GB std, 4GB max ⁸ , PC2-5300 667MHz DDR2, non-parity, dual-channel capable, two 200-pin SODIMM sockets (notebook); Non-italics: standard memory in one socket; one socket available	Bay ① 5.25", 1.6" high, access, std optical Bay ② 3.5", 1" high, no access, std disk Slots: None	
Graphics	Intel Graphics Media Accelerator 3100 (GMA 3100), integrated graphics in Q35, uses main memory (up to 256MB), one analog VGA DB-15 connector, one DVI-D connector, supports dual independent display	<ul style="list-style-type: none"> • Business black color; metal case • 10.8" W X 9.5" D X 3.2" H • 275mm W X 242mm D X 81mm H • 7.2 to 8.2lb (3.3 to 3.7kg) • Toolless disk and optical drive removal • Hinged toolless cover for easy serviceability • Steel chassis supports 110 lb (50kg) monitor on top • Supports Vertical PC and Monitor Stand (41R4359) 	
SATA disk	160GB or 320GB, SATA 3.0Gb/s 7200 rpm, vibration dampening	<p align="center">Security</p> <ul style="list-style-type: none"> • Security chip (see information on left) • Security slot (in rear for attachment of optional Kensington® Microsaver® cable) - optional cable also locks the cover by deactivating the cover release buttons • Power-on password • Administrator password • Hard disk password • Boot sequence control • Boot without keyboard, mouse • Individual USB port disablement • Chassis intrusion switch • Some: Serial port disablement 	
SATA controller	Serial ATA, SATA 3.0Gb/s, integrated in ICH9DO		
SATA DVD	Some: DVD-ROM DL SATA 1.5Gb/s 16-48X Max ⁴ Drive (41N5618)		
SATA DVD±RW	Some: Super Multi-Burner DL DVD±RW SATA Drive (41N5620)		
SATA cables	Two SATA cables (each 1-drop to device), two SATA connectors on planar		
eSATA port	None	Supports ThinkVantage® technologies	
EIDE controller	None		
Diskette drive	None		
Media reader	None		
Chipset	Intel Q35 Express Chipset; I/O Controller Hub 9 Digital Office (ICH9DO) for SATA 3.0Gb/s, PCI Express® x1, ethernet (MAC), PCI 2.3, USB, LPC bus / SMSC® SCH5617 Super I/O for [serial], hardware monitoring (temperature, voltage, fan speed)		
Front ports	Two USB 2.0, microphone (stereo, 3.5mm), headphone (stereo, 3.5mm)	<p align="center">Limited Warranty¹</p> <ul style="list-style-type: none"> ⇨ 3-year parts and labor ⇨ International Warranty Service⁹ ⇨ Customer Replaceable Unit (CRU) parts only (with limited onsite service for selected parts³, 8 am - 5 pm, Mon - Fri coverage excluding holidays, next business day response time) ⇨ Onsite service upgrade options (in eligible locations):⁷ <ul style="list-style-type: none"> • 3-year LOR 9x5, 4 hour response (ThinkPlus™ part number 41C9192) • 3-year LOR 24x7, 4 hour response (ThinkPlus part number 41C9193) • 4-year LOR 9x5, Next Business Day (ThinkPlus part number 41C9194) • 4-year LOR 9x5, 4 hour response (ThinkPlus part number 41C9195) • 4-year LOR 24x7, 4 hour response (ThinkPlus part number 41C9196) ⇨ ThinkPlus services at lenovo.com/thinkplus/warranty ⇨ Post warranty maintenance services available ⇨ 24 hour x 7 day¹⁴ toll-free support during the warranty period¹ via 800-426-7378 	
Rear ports	Four USB 2.0, ethernet (RJ-45), monitor (VGA DB-15, DVI-D), Some: serial (9-pin)		
Rear audio ports	Line-in (stereo, 3.5mm), line-out (stereo, 3.5mm), microphone (stereo, 3.5mm)		
Audio	High Definition (HD) Audio, Analog Devices AD1882 codec		
Speaker	One internal speaker for business audio		
Ethernet	Gigabit ethernet on planar, Intel 82566DM (PHY layer; MAC in ICH9DO), PCIe x1, Intel AMT 3.0, ASF 2.0, Wake on LAN [®]		
Intel AMT	Intel Active Management Technology (iAMT)		
Modem	None		
Security chip	Winbond® WPCT200 SafeKeeper™ Trusted Platform Module, TCG 1.2-compliant		
Keyboard	Preferred Pro USB Keyboard (USB connector), 104-key, black, Lenovo logo		
Mouse	Optical Wheel Mouse (USB connector), black, Lenovo logo		
Power supply	External AC/DC adapter, 120 watts, autosensing, 85% PSU		
Preloaded operating system²⁰			
- Microsoft® Windows® Vista® Business Edition (32-bit)			
⇨ Vista Basic logo			
Preloaded applications⁵			
• Some (HE): Higher education software			
- VitalSource Library College Edition			
- Adobe® Instructor Resource Center			
- Adobe Photoshop Elements 5 (and CD)			
- Adobe Premier Elements 3 (and DVD)			
• Rescue and Recovery™			
• Client Security Solution™			
• ThinkVantage Productivity Center			
• ThinkVantage System Update			
• System Migration Assistant			
• Norton Internet Security™			
• Diskeeper® Home			
• PC-Doctor™ (diagnostics)			
• Adobe Reader			
• Windows Live™ Toolbar			
• Windows Live Search			
• Picasa from Google			
• Microsoft Office 2007 Trial (60-day)			
• Sonic RecordNow and Drive Letter Access (DVD±RW)			
• Corel® WinDVD® (DVD, DVD±RW)			
Accessories			
1GB PC2-5300 DDR2 SODIMM (notebook)	43R1763		
2GB PC2-5300 DDR2 SODIMM (notebook)	43R1756		
500GB SATA 3.0Gb/s Disk (7200 rpm)	43R1990		
1TB SATA 3.0Gb/s Disk (7200 rpm)	45J7918		
USB 2.0 Lenovo Multimedia Headset	40Y8518		
USB 2.0 Lenovo Webcam	40Y8519		
USB 2.0 Essential Memory Key 32GB	45K1258		
USB 2.0 Security Memory Key 4GB	41U5120		
USB 2.0 Ultra Secure Memory Key 2GB	45J5916		
USB 2.0 Ultra Secure Memory Key 4GB	45J5917		
USB 2.0 Ultra Secure Memory Key 8GB	45J5918		
USB 2.0 Portable 160GB Hard Disk	43R1784		
USB 2.0 Portable Secure 320GB Hard Disk	43R2019		
ThinkVision® L1700p 17" Monitor	9417HE2		
ThinkVision L1940p Wide 19" Monitor	4424HB6		
ThinkVision L2240p Wide 22" Monitor	4422HB6		
ThinkVision L2440p Wide 24" Monitor	4420HB2		
ThinkCentre Ultra Small Under Desk Mount	40Y8625		
Lenovo Vertical PC and Monitor Stand	41R4359		
Wireless Kbd & Opt Wheel Mouse (via USB)	73P4067		
USB Travel Keyboard with UltraNav™	31P9490		
Laser Tilt Wheel Mouse (USB, PS/2)	41U3074		
Kensington Cable Lock from Lenovo	73P2582		
Acc Guide in pdf lenovo.com/accessoriesguide			
Other accessories at lenovo.com/accessories			

See footnotes for important warranty information
US models announced February 12, 2008

ThinkCentre® M57p Eco Ultra Small (6395) - August 2008

Personal Systems Reference (PSREF)

Name	Type-model	Slot x bay	Processor	GHz	L2 cache	Memory ⁶	SATA disk	SATA optical	Graphics	DVI-D conn	Intel vPro	Card slot	Serial port	Preload	Global Educ	Avail date
M57p	6395-57U	0x2	Core 2 Duo E8200	2.66	6MB	1GB	160GB ²	DVD	GMA	DVI-D	vPro		Serial	XP Pro	None	Sep 08
M57p	6395-56U	0x2	Core 2 Duo E8200	2.66	6MB	2GB	250GB	DVD±RW	GMA	DVI-D	vPro	/54	Serial	XP Pro	None	Sep 08
M57p	6395-54U	0x2	Core 2 Duo E8400	3.00	6MB	1GB	160GB	DVD	GMA	DVI-D	vPro		Serial	XP Pro	None	Sep 08
M57p	6395-55U	0x2	Core 2 Duo E8400	3.00	6MB	2GB	250GB	DVD±RW	GMA	DVI-D	vPro	/54	Serial	XP Pro	None	Sep 08

- **Intel Core 2 Processor with vPro™ Technology (includes Intel Active Management Technology)**
- **Only 4.5 liter volume (25% less than the 6.3 liter ThinkCentre M57 Ultra Small)**
- **Best acoustic and lowest power consumption of all Lenovo desktops**
- **These models have a 3-year limited warranty¹**

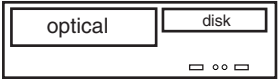
Positioning Processor	<i>Ultimate enterprise stability and manageability for large enterprise</i> Intel® Core™ 2 Duo Processor E8200 or E8400 with dual-core , Intel 64 Technology, Virtualization Technology, Execute Disable Bit, EIST, TXT, and 1333MHz system bus with 6MB shared L2 cache Processor in FC-LGA8 package in LGA775 socket		Eco Ultra Small	
Implementation	Processor in FC-LGA8 package in LGA775 socket			
Memory	1GB or 2GB std , 4GB max ⁸ , PC2-5300 667MHz DDR2 , non-parity, dual-channel capable, two 200-pin SODIMM sockets (notebook); <i>Italics:</i> standard memory in both sockets; no sockets avail; <i>Non-italics:</i> standard memory in one socket; one socket available		Bay ① 5.25", 1.6" high, access, std optical Bay ② 3.5", 1" high, no access, std disk Slots: None	
Graphics	Intel Graphics Media Accelerator 3100 (GMA 3100) , integrated graphics in Q35, uses main memory (up to 256MB), one analog VGA DB-15 connector, one DVI-D connector, supports dual independent display		<ul style="list-style-type: none"> • Business black color; metal case • 10.8" W X 9.5" D X 3.2" H • 275mm W X 242mm D X 81mm H • 7.2 to 8.2lb (3.3 to 3.7kg) • Toolless disk and optical drive removal • Hinged toolless cover for easy serviceability • Steel chassis supports 110 lb (50kg) monitor on top • Supports Vertical PC and Monitor Stand (41R4359) 	
SATA disk	160GB or 250GB , SATA 3.0Gb/s 7200 rpm, vibration dampening		<p align="center">Security</p> <ul style="list-style-type: none"> • Security chip (see information on left) • Security slot (in rear for attachment of optional Kensington® Microsaver® cable) - optional cable also locks the cover by deactivating the cover release buttons • Power-on password • Administrator password • Hard disk password • Boot sequence control • Boot without keyboard, mouse • Individual USB port disablement • <i>Some:</i> Serial port disablement <p align="center">Supports ThinkVantage® technologies</p> <p align="center">EPEAT™ Gold rating ENERGY STAR® 4.0-compliant GREENGUARD® certified RoHS-compliant</p> <p align="center">Limited Warranty¹</p> <ul style="list-style-type: none"> ↔ 3-year parts and labor ↔ International Warranty Service⁹ ↔ Customer Replaceable Unit (CRU) parts only (with limited onsite service for selected parts³, 8 am - 5 pm, Mon - Fri coverage excluding holidays, next business day response time) ↔ Onsite service upgrade options (in eligible locations):⁷ <ul style="list-style-type: none"> • 3-year LOR 9x5, 4 hour response (ThinkPlus™ part number 41C9192) • 3-year LOR 24x7, 4 hour response (ThinkPlus part number 41C9193) • 4-year LOR 9x5, Next Business Day (ThinkPlus part number 41C9194) • 4-year LOR 9x5, 4 hour response (ThinkPlus part number 41C9195) • 4-year LOR 24x7, 4 hour response (ThinkPlus part number 41C9196) ↔ ThinkPlus services at lenovo.com/thinkplus/warranty ↔ Post warranty maintenance services available ↔ 24 hour x 7 day¹⁴ toll-free support during the warranty period¹ via 800-426-7378 	
SATA controller	Serial ATA, SATA 3.0Gb/s, integrated in ICH9DO			
SATA DVD	<i>Some:</i> DVD-ROM DL SATA 1.5Gb/s 16-48X Max ⁴ Drive (41N5618)			
SATA DVD±RW	<i>Some:</i> Super Multi-Burner DL DVD±RW SATA 1.5Gb/s Drive (41N5620)			
SATA cables	Two SATA cables (each 1-drop to device), two SATA connectors on planar			
eSATA port	None			
EIDE controller	None			
Diskette drive	None			
Media reader	None			
Chipset	Intel Q35 Express Chipset: I/O Controller Hub 9 Digital Office (ICH9DO) for SATA 3.0Gb/s, PCI Express® x1, ethernet (MAC), PCI 2.3, USB, LPC bus / SMSC® SCH5617 Super I/O for [serial], hardware monitoring (temperature, voltage, fan speed)			
Front ports	Two USB 2.0, microphone (stereo, 3.5mm), headphone (stereo, 3.5mm)			
Rear ports	Four USB 2.0, ethernet (RJ-45), monitor (VGA DB-15, DVI-D), <i>Some:</i> serial (9-pin)			
ExpressCard/54	<i>Some:</i> One slot (ExpressCard/34, ExpressCard/54)			
Rear audio ports	Line-in (stereo, 3.5mm), line-out (stereo, 3.5mm), microphone (stereo, 3.5mm)			
Audio	High Definition (HD) Audio, Analog Devices AD1882 codec			
Speaker	One internal speaker for business audio			
Ethernet	Gigabit ethernet on planar, Intel 82566DM (PHY layer; MAC in ICH9DO), PCIe x1, Intel AMT 3.0, ASF 2.0, Wake on LAN®			
Intel AMT	Intel Active Management Technology (iAMT)			
Modem	None			
Security chip	Winbond® WPCT200 SafeKeeper™ Trusted Platform Module, TCG 1.2-compliant			
Keyboard	Preferred Pro USB Keyboard (USB connector), 104-key, black, Lenovo logo			
Mouse	Optical Wheel Mouse (USB connector), black, Lenovo logo			
Power supply	External AC/DC adapter, 120 watts, autosensing, 85% PSU			
Preloaded operating system²⁰	Accessories			
- Microsoft® Windows® XP Professional with Vista® COA	1GB PC2-5300 DDR2 SODIMM (notebook) 43R1763			
↕ Disk-to-Disk Recovery (in hidden protected area)	2GB PC2-5300 DDR2 SODIMM (notebook) 43R1756			
	500GB SATA 3.0Gb/s Disk (7200 rpm) 43R1990			
	1TB SATA 3.0Gb/s Disk (7200 rpm) 45J7918			
	USB 2.0 Lenovo Multimedia Headset 40Y8518			
	USB 2.0 Lenovo Webcam 40Y8519			
	USB 2.0 Essential Memory Key 32GB 45K1258			
	USB 2.0 Ultra Secure Memory Key 2GB 45J5916			
	USB 2.0 Ultra Secure Memory Key 4GB 45J5917			
	USB 2.0 Ultra Secure Memory Key 8GB 45J5918			
	USB 2.0 Portable 160GB Hard Disk 43R1784			
	USB 2.0 Portable Secure 320GB Hard Disk 43R2019			
	ThinkVision® L1700p 17" Monitor 9417HE2			
	ThinkVision L1940p Wide 19" Monitor 4424HB6			
	ThinkVision L2240p Wide 22" Monitor 4422HB6			
	ThinkVision L2440p Wide 24" Monitor 4420HB2			
	ThinkCentre Ultra Small Under Desk Mount 40Y8625			
	Lenovo Vertical PC and Monitor Stand 41R4359			
	Wireless Kbd & Opt Wheel Mouse (via USB) 73P4067			
	USB Travel Keyboard with UltraNav™ 31P9490			
	Laser Tilt Wheel Mouse (USB, PS/2) 41U3074			
	Kensington Cable Lock from Lenovo 73P2582			
	Acc Guide in pdf lenovo.com/accessoriesguide			
	Other accessories at lenovo.com/accessories			

See footnotes for important warranty information
US models announced August 19, 2008

© Lenovo
(BLLF1-5) September 2008

ThinkCentre® M57p Eco Ultra Small (6397) - GMP

Personal Systems Reference (PSREF)

Name	Type-model	Slot x bay	Processor	GHz	L2 cache	Memory ⁸	SATA disk	SATA optical	Graphics	DVI-D conn	Intel vPro	Serial port	Vista preload	Limited warranty ¹	Global (G) GMP (P)	Avail date
M57p	6397-11U	0x2	Core 2 Duo E8200	2.66	6MB	2GB	160GB ²	DVD	GMA	DVI-D	vPro	None	Business32	3-yr	G P	Feb 08

- **This model is part of the Global Models Plus (GMP) program with limited onsite service³ 3-year limited warranty**
- **Intel Core 2 Processor with vPro™ Technology (includes Intel Active Management Technology)**
- **Only 4.5 liter volume (25% less than the 6.3 liter ThinkCentre M57 Ultra Small)**
- **Best acoustic and lowest power consumption of all Lenovo desktops**

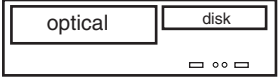
Positioning Processor	<i>Ultimate enterprise stability and manageability for large enterprise</i>		Eco Ultra Small			
Implementation	Intel® Core™ 2 Duo Processor E8200 with dual-core, Intel 64 Technology, Virtualization Technology, Execute Disable Bit, EIST, TXT, and 1333MHz system bus with 6MB shared L2 cache Processor in FC-LGA8 package in LGA775 socket		Bay ① 5.25", 1.6" high, access, std optical Bay ② 3.5", 1" high, no access, std disk Slots: None			
Memory	2GB std , 4GB max ⁹ , PC2-5300 667MHz DDR2 , non-parity, dual-channel capable, two 200-pin SODIMM sockets (notebook); <i>Non-italics</i> : standard memory in one socket; one socket available		<ul style="list-style-type: none"> • Business black color; metal case • 10.8" W X 9.5" D X 3.2" H • 275mm W X 242mm D X 81mm H • 7.2 to 8.2lb (3.3. to 3.7kg) • Toolless disk and optical drive removal • Hinged toolless cover for easy serviceability • Steel chassis supports 110 lb (50kg) monitor on top • Supports Vertical PC and Monitor Stand (41R4359) 			
Graphics	Intel Graphics Media Accelerator 3100 (GMA 3100) , integrated graphics in Q35, uses main memory (up to 256MB), one analog VGA DB-15 connector, one DVI-D connector, supports dual independent display		Security <ul style="list-style-type: none"> • Security chip (see information on left) • Security slot (in rear for attachment of optional Kensington® Microsaver® cable) <ul style="list-style-type: none"> - optional cable also locks the cover by deactivating the cover release buttons • Power-on password • Administrator password • Hard disk password • Boot sequence control • Boot without keyboard, mouse • Individual USB port disablement • Chassis intrusion switch 			
SATA disk	160GB , SATA 3.0Gb/s 7200 rpm, vibration dampening mounts					
SATA controller	Serial ATA, SATA 3.0Gb/s, integrated in ICH9DO					
SATA DVD	DVD-ROM DL SATA 1.5Gb/s 16-48X Max ⁴ Drive (41N5618)					
SATA cables	Two SATA cables (each 1-drop to device), two SATA connectors					
eSATA port	None					
EIDE controller	None					
Diskette drive	None					
Media reader	None					
Chipset	Intel Q35 Express Chipset ; I/O Controller Hub 9 Digital Office (ICH9DO) for SATA 3.0Gb/s, PCI Express [®] x1, ethernet (MAC), PCI 2.3, USB, LPC bus / SMSC [®] SCH5617 Super I/O for hardware monitoring (temperature, voltage, fan speed)					
Front ports	Two USB 2.0, microphone (stereo, 3.5mm), headphone (stereo, 3.5mm)					
Rear ports	Four USB 2.0, ethernet (RJ-45), monitor (VGA DB-15, DVI-D)					
Rear audio ports	Line-in (stereo, 3.5mm), line-out (stereo, 3.5mm), microphone (stereo, 3.5mm)					
Audio	High Definition (HD) Audio, Analog Devices AD1882 codec					
Speaker	One internal speaker for business audio					
Ethernet	Gigabit ethernet on planar, Intel 82566DM (PHY layer; MAC in ICH9DO), PCIe x1, Intel AMT 3.0, ASF 2.0, Wake on LAN [®]					
Intel AMT	Intel Active Management Technology (iAMT)					
Modem	None					
Security chip	Winbond [®] WPCT200 SafeKeeper™ Trusted Platform Module, TCG 1.2-compliant					
Keyboard	Preferred Pro USB Keyboard (USB connector), 104-key, black, Lenovo logo					
Mouse	Optical Wheel Mouse (USB connector), black, Lenovo logo					
Power supply	External AC/DC adapter, 120 watts, autosensing, 85% PSU				Supports ThinkVantage [®] technologies	
Preloaded operating system²⁰	<ul style="list-style-type: none"> - Microsoft[®] Windows[®] Vista[®] Business Edition (32-bit) ◇ Vista Basic logo 		Accessories		EPEAT™ Gold rating ENERGY STAR [®] 4.0-compliant GREENGUARD [®] certified RoHS-compliant	
Preloaded applications⁵	<ul style="list-style-type: none"> • Rescue and Recovery™ • Client Security Solution™ • ThinkVantage Productivity Center • ThinkVantage System Update • System Migration Assistant • Norton Internet Security™ (90 days of virus definitions) • Diskeeper[®] Home • PC-Doctor™ (diagnostics) • Adobe[®] Reader • Windows Live™ Toolbar • Windows Live Search • Picasa from Google • Microsoft Office 2007 Trial (60-day) • Corel[®] WinDVD[®] (DVD) 		<ul style="list-style-type: none"> 1GB PC2-5300 DDR2 SODIMM (notebook) 43R1763 2GB PC2-5300 DDR2 SODIMM (notebook) 43R1756 500GB SATA 3.0Gb/s Disk (7200 rpm) 43R1990 1TB SATA 3.0Gb/s Disk (7200 rpm) 45J7918 USB Portable Diskette Drive 05K9276 USB 2.0 Lenovo Multimedia Headset 40Y8518 USB 2.0 Lenovo Webcam 40Y8519 USB 2.0 Essential Memory Key 32GB 45K1258 USB 2.0 Security Memory Key 4GB 41U5120 USB 2.0 Ultra Secure Memory Key 2GB 45J5916 USB 2.0 Ultra Secure Memory Key 4GB 45J5917 USB 2.0 Ultra Secure Memory Key 8GB 45J5918 USB 2.0 Portable 160GB Hard Disk 43R1784 USB 2.0 Portable Secure 320GB Hard Disk 43R2019 Super Multi-Burner DL DVD±RW SATA Drive 41N5620 ThinkVision[®] L1700p 17" Monitor 9417HE2 ThinkVision L1940p Wide 19" Monitor 4424HB6 ThinkVision L2240p Wide 22" Monitor 4422HB6 ThinkVision L2440p Wide 24" Monitor 4420HB2 ThinkCentre Ultra Small Under Desk Mount 40Y8625 Lenovo Vertical PC and Monitor Stand 41R4359 Wireless Kbd & Opt Wheel Mouse (via USB) 73P4067 USB Travel Keyboard with UltraNav™ 31P9490 Laser Tilt Wheel Mouse (USB, PS/2) 41U3074 Kensington Cable Lock from Lenovo 73P2582 Acc Guide in pdf lenovo.com/accessoriesguide Other accessories at lenovo.com/accessories 		Limited Warranty¹ <ul style="list-style-type: none"> ⇨ 3-year parts and labor ⇨ International Warranty Service⁹ ⇨ Customer Replaceable Unit (CRU) parts only (with limited onsite service for selected parts³, 8 am - 5 pm, Mon - Fri coverage excluding holidays, next business day response time) ⇨ Onsite service upgrade options (in eligible locations):⁷ <ul style="list-style-type: none"> • 4-year LOR 9x5, Next Business Day (ThinkPlus™ part number 41C9194) • 4-year LOR 9x5, 4 hour response (ThinkPlus part number 41C9195) • 4-year LOR 24x7, 4 hour response (ThinkPlus part number 41C9196) ⇨ ThinkPlus services at lenovo.com/thinkplus/warranty ⇨ Post warranty maintenance services available ⇨ 24 hour x 7 day¹⁴ toll-free support during the warranty period¹ via 800-426-7378 	

See footnotes for important warranty information
 US model announced February 12, 2008

Name	Type-model	Slot x bay	Processor	GHz	L2 cache	Memory ⁹	SATA disk	EIDE optical	Graphics	eSATA port	Intel vPro	Preload	Limited warranty ¹	Global Educ	Avail date
⚠	M57	6071-BDU	1x2	Pentium E2140	1.60	1MB 1GB	80GB ²	Combo	GMA	eSATA	None	XP Pro	3-yr		Oct 07
⚠	M57	6071-B8U	1x2	Pentium E2160	1.80	1MB 1GB	80GB	Combo	GMA	eSATA	None	Business32	3-yr	Gbl	Nov 07
	M57	6071-B9U	1x2	Pentium E2160	1.80	1MB 1GB	160GB	DVD±RW	GMA	eSATA	None	Business32	3-yr		Oct 07
⚠	M57	6071-A2U	1x2	Core 2 Duo E4400	2.00	2MB 1GB	80GB	Combo	GMA	eSATA	None	Business32	3-yr		Oct 07
⚠	M57	6071-ACU	1x2	Core 2 Duo E4400	2.00	2MB 1GB	160GB	DVD±RW	GMA	eSATA	None	Business32	3-yr		Oct 07
	M57	6071-A3U	1x2	Core 2 Duo E6550	2.33	4MB 1GB	80GB	Combo	GMA	eSATA	None	Business32	3-yr	Gbl	Oct 07
	M57	6071-ADU	1x2	Core 2 Duo E6550	2.33	4MB 1GB	160GB	DVD±RW	GMA	eSATA	None	Business32	3-yr		Oct 07

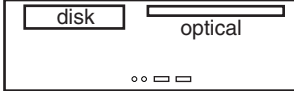
Positioning Processor	<p><i>Ultimate enterprise stability for large enterprise and mid-market</i> Intel® Pentium® Dual-Core Processor E2140 or E2160 with dual-core, Intel 64 Technology, Execute Disable Bit, EIST, 800MHz system bus, and 1MB shared L2 cache or Intel Core™ 2 Duo Processor E4400 with dual-core, Intel 64 Technology, Execute Disable Bit, EIST, 800MHz system bus, and 2MB shared L2 cache or Intel Core 2 Duo Processor E6550 with dual-core, Intel 64 Technology, Virtualization Technology, Execute Disable Bit, EIST, TXT, and 1333MHz system bus with 4MB shared L2 cache Processor in FC-LGA6 package in LGA775 socket</p>		<p>Ultra Small</p> 
Implementation	<p>Bay ① 3.5", 1" high, no access, std disk (desktop) Bay ② 5.25", *.5" high, access, std optical (notebook)</p> <p>* Optical bay is Ultrabay™ Enhanced 12.7mm high (uses select ThinkPad-based Ultrabay Enhanced [12.7mm high] and Ultrabay Slim [9.5mm high] devices)</p>		
Memory	<p>1GB std, 4GB max⁹, PC2-5300 667MHz DDR2, non-parity, dual-channel capable, two 240-pin DIMM sockets; <i>Non-italics</i>: standard memory in one socket; one socket available</p>		<p>Slot 1: half-length (175mm), full-height, 32-bit PCI 2.3 (5v)</p> <ul style="list-style-type: none"> • Business black color; metal case • 10.9" W X 10.7" D X 3.5" H • 276mm W X 273mm D X 89mm H • 14.1 lb (6.4 kg) in maximum configuration • Toolless cover flips up and tilts backward on rear hinges • Toolless disk and optical drive removal • Bays 1 and 2 flip up (latched and pivoting) • Toolless PCI slot and riser card retention • Steel chassis supports 100 lb (45kg) monitor on top • System floor stand for vertical orientation
Graphics	<p>Intel Graphics Media Accelerator 3100 (GMA 3100), integrated graphics in Q35, uses main memory (up to 256MB), one analog VGA DB-15 connector</p>		<p>Security</p> <ul style="list-style-type: none"> • Security chip (see information on left) • Security slot (in rear for attachment of optional Kensington® Microsaver® cable) - optional cable also locks the cover by deactivating the cover release buttons • Power-on password • Administrator password • Hard disk password • Boot sequence control • Boot without keyboard, mouse • Serial port I/O control • Parallel port I/O control • Individual USB port disablement • eSATA port disablement <p>Supports ThinkVantage® technologies</p> <p>RoHS-compliant</p> <p>Limited Warranty¹</p> <ul style="list-style-type: none"> ↪ 3-year parts and labor ↪ International Warranty Service⁹ ↪ Customer Replaceable Unit (CRU) parts only (with limited onsite service for selected parts³, 8 am - 5 pm, Mon - Fri coverage excluding holidays, next business day response time) ↪ Onsite service upgrade options (in eligible locations):⁷ <ul style="list-style-type: none"> • 3-year LOR 9x5, 4 hour response (ThinkPlus™ part number 41C9192) • 3-year LOR 24x7, 4 hour response (ThinkPlus part number 41C9193) • 4-year LOR 9x5, Next Business Day (ThinkPlus part number 41C9194) • 4-year LOR 9x5, 4 hour response (ThinkPlus part number 41C9195) • 4-year LOR 24x7, 4 hour response (ThinkPlus part number 41C9196) ↪ ThinkPlus services at lenovo.com/thinkplus/warranty ↪ Post warranty maintenance services available ↪ 24 hour x 7 day¹⁴ toll-free support during the warranty period¹ via 800-426-7378
SATA disk	<p>80GB or 160GB, SATA 3.0Gb/s 7200 rpm, vibration dampening</p>		
SATA controller	<p>Serial ATA, SATA 3.0Gb/s, integrated in ICH9</p>		
SATA cables	<p>One SATA cable (1-drop to disk), one SATA connector on planar</p>		
eSATA port	<p>One external SATA (eSATA) port</p>		
EIDE Combo	<p><i>Some:</i> 24X/24X/24X/8X Max¹¹ CD-RW/DVD-ROM Combo Drive, Ultrabay Enhanced (12.7mm high)</p>		
EIDE DVD±RW	<p><i>Some:</i> Multi-Burner DL DVD±RW Drive, Ultrabay Enhanced (12.7mm high)</p>		
EIDE controller	<p>Enhanced IDE, ATA-133, via EIDE bridge Silicon Image™ SIL3811 from ICH9</p>		
EIDE cables	<p>One cable (one 1-drop Ultrabay Enhanced cable to optical), one EIDE connector (Ultrabay Enhanced) on systemboard</p>		
Diskette drive	<p>None</p>		
Media reader	<p>None</p>		
Chipset	<p>Intel Q35 Express Chipset; I/O Controller Hub 9 (ICH9) for SATA 3.0Gb/s, PCI Express® x1, ethernet (MAC), PCI 2.3, USB, LPC bus / SMSC® SCH5617 Super I/O for serial, parallel, diskette, hardware monitoring (temperature, voltage, fan speed)</p>		
Front ports	<p>Two USB 2.0, microphone (stereo, 3.5mm), headphone (stereo, 3.5mm)</p>		
Rear ports	<p>Six USB 2.0, serial (9-pin), parallel (25-pin), ethernet (RJ-45), monitor (VGA DB-15), eSATA</p>		
Rear audio ports	<p>Line-in (stereo, 3.5mm), line-out (stereo, 3.5mm)</p>		
Audio	<p>High Definition (HD) Audio, Analog Devices AD1882 codec</p>		
Speaker	<p>One internal speaker for business audio</p>		
Ethernet	<p>Gigabit ethernet on planar, Intel 82566DM, PCIe x1, Wake on LAN®, ASF2.0</p>		
Intel AMT	<p>None</p>		
Modem	<p>None</p>		
Security chip	<p>Winbond® WPCT200 SafeKeeper™ Trusted Platform Module, TCG 1.2-compliant</p>		
Keyboard	<p>Preferred Pro USB Keyboard (USB connector), 104-key, black, Lenovo logo</p>		
Mouse	<p>Optical Wheel Mouse (USB connector), black, Lenovo logo</p>		
Power supply	<p>225 watts with variable speed fan, autosensing, two diagnostic LEDs</p>		
Preloaded operating system²⁰	<p>Accessories</p>		
- <i>Some:</i> Microsoft® Windows® XP Professional	1GB PC2-5300 CL5 NP DDR2 UDIMM	73P4984	
- <i>Some:</i> Microsoft Windows Vista® Business Edition (32-bit)	2GB PC2-5300 CL5 NP DDR2 UDIMM	73P4985	
↕ <i>Vista models:</i> Vista Basic logo	1GB PC2-6400 NP DDR2 UDIMM	41U2977	
Preloaded applications⁵ (all OSes; only some listed)	2GB PC2-6400 NP DDR2 UDIMM	41U2978	
• Rescue and Recovery™	250GB SATA 3.0Gb/s Disk (7200 rpm)	41N3015	
• Client Security Solution™	500GB SATA 3.0Gb/s Disk (7200 rpm)	43R1990	
• ThinkVantage Productivity Center	USB 2.0 Lenovo Multimedia Headset	40Y8518	
• ThinkVantage System Update	USB 2.0 Lenovo Webcam	40Y8519	
• System Migration Assistant	USB 2.0 Essential Memory Key 32GB	45K1258	
• Norton Internet Security™	USB 2.0 Ultra Secure Memory Key 8GB	45J5918	
• Diskeeper® Home	USB 2.0 Portable Secure 320GB Hard Disk	43R2019	
• PC-Doctor™ (diagnostics)	USB 2.0 Super Multi-Burner Drive	41N5565	
• Picasa from Google	ThinkVision® L1700p 17" Monitor	9417HE2	
• Microsoft Office 2007 Trial (60-day)	ThinkVision L1940p Wide 19" Monitor	4424HB6	
• Sonic RecordNow and Drive Letter Access (combo, DVD±RW)	ThinkVision L2240p Wide 22" Monitor	4422HB6	
• Corel® WinDVD® (combo, DVD±RW)	ThinkVision L2440p Wide 24" Monitor	4420HB2	
	ThinkCentre Ultra Small Under Desk Mount	40Y8625	
	Wireless Kbd & Opt Wheel Mouse (via USB)	73P4067	
	Laser Tilt Wheel Mouse (USB, PS/2)	41U3074	
	Kensington Cable Lock from Lenovo	73P2582	
	Other accessories at lenovo.com/accessories		

See footnotes for important warranty information

⚠ US model announced October 16, 2007; previous models on September 18, 2007

⚠ US models withdrawn effective June or September 2008

Name	Type-model	Slot x bay	Processor	GHz	L2 cache	Memory ⁸	SATA disk	EIDE optical	Graphics	eSATA port	Intel vPro	Preload	Limited warranty ¹	Global Educ	Avail date
M57	6071-BRU	1x2	Core 2 Duo E8200	2.66	6MB	1GB	160GB ²	Combo	GMA	eSATA	None	XP Pro	3-yr	None	Feb 08
M57	6071-DJU	1x2	Core 2 Duo E4500	2.20	2MB	1GB	160GB	DVD	GMA	eSATA	None	Business32	3-yr	None	Feb 08
M57	6071-DHU	1x2	Core 2 Duo E4500	2.20	2MB	1GB	160GB	Combo	GMA	eSATA	None	Business32	3-yr	None	Feb 08
M57	6071-BQU	1x2	Core 2 Duo E8200	2.66	6MB	1GB	160GB	Combo	GMA	eSATA	None	Business32	3-yr	None	Feb 08

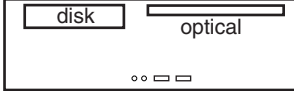
Positioning Processor	<p><i>Ultimate enterprise stability for large enterprise and mid-market</i> Intel® Core™ 2 Duo Processor E4500 with dual-core, Intel 64 Technology, Execute Disable Bit, EIST, 800MHz system bus, and 2MB shared L2 cache or Intel Core 2 Duo Processor E8200 with dual-core, Intel 64 Technology, Virtualization Technology, Execute Disable Bit, EIST, TXT, and 1333MHz system bus with 6MB shared L2 cache Processor in FC-LGA6 or FC-LGA8 package in LGA775 socket</p>		<p>Ultra Small</p> 
Implementation			<p>Bay ① 3.5", 1" high, no access, std disk (desktop) Bay ② 5.25", *.5" high, access, std optical (notebook)</p> <p>* Optical bay is Ultrabay™ Enhanced 12.7mm high (uses select ThinkPad-based Ultrabay Enhanced [12.7mm high] and Ultrabay Slim [9.5mm high] devices)</p>
Memory	<p>1GB std, 4GB max⁸, PC2-5300 667MHz DDR2, non-parity, dual-channel capable, two 240-pin DIMM sockets; <i>Non-italics</i>: standard memory in one socket; one socket available</p>		<p>Slot 1: half-length (175mm), full-height, 32-bit PCI 2.3 (5v)</p> <ul style="list-style-type: none"> • Business black color; metal case • 10.9" W X 10.7" D X 3.5" H • 276mm W X 273mm D X 89mm H • 14.1 lb (6.4 kg) in maximum configuration • Toolless cover flips up and tilts backward on rear hinges • Toolless disk and optical drive removal • Bays 1 and 2 flip up (latched and pivoting) • Toolless PCI slot and riser card retention • Steel chassis supports 100 lb (45kg) monitor on top • System floor stand for vertical orientation
Graphics	<p>Intel Graphics Media Accelerator 3100 (GMA 3100), integrated graphics in Q35, uses main memory (up to 256MB), one analog VGA DB-15 connector</p>		<p>Security</p> <ul style="list-style-type: none"> • Security chip (see information on left) • Security slot (in rear for attachment of optional Kensington® Microsaver® cable) - optional cable also locks the cover by deactivating the cover release buttons • Power-on password • Administrator password • Hard disk password • Boot sequence control • Boot without keyboard, mouse • Serial port I/O control • Parallel port I/O control • Individual USB port disablement • eSATA port disablement <p>Supports ThinkVantage® technologies</p> <p>RoHS-compliant</p> <p>Limited Warranty¹</p> <ul style="list-style-type: none"> ⇒ 3-year parts and labor ⇒ International Warranty Service⁹ ⇒ Customer Replaceable Unit (CRU) parts only (with limited onsite service for selected parts³, 8 am - 5 pm, Mon - Fri coverage excluding holidays, next business day response time) ⇒ Onsite service upgrade options (in eligible locations)⁷ <ul style="list-style-type: none"> • 3-year LOR 9x5, 4 hour response (ThinkPlus™ part number 41C9192) • 3-year LOR 24x7, 4 hour response (ThinkPlus part number 41C9193) • 4-year LOR 9x5, Next Business Day (ThinkPlus part number 41C9194) • 4-year LOR 9x5, 4 hour response (ThinkPlus part number 41C9195) • 4-year LOR 24x7, 4 hour response (ThinkPlus part number 41C9196) ⇒ ThinkPlus services at lenovo.com/thinkplus/warranty ⇒ Post warranty maintenance services available ⇒ 24 hour x 7 day¹⁴ toll-free support during the warranty period¹ via 800-426-7378
SATA disk	<p>160GB, SATA 3.0Gb/s 7200 rpm, vibration dampening mounts</p>		
SATA controller	<p>Serial ATA, SATA 3.0Gb/s, integrated in ICH9</p>		
SATA cables	<p>One SATA cable (1-drop to disk), one SATA connector on planar</p>		
eSATA port	<p>One external SATA (eSATA) port</p>		
EIDE DVD	<p><i>Some</i>: 8X/24X Max⁴ DVD-ROM, Ultrabay Enhanced (12.7mm)</p>		
EIDE Combo	<p><i>Some</i>: 24X/24X/24X/8X Max¹¹ CD-RW/DVD-ROM Combo, Ultrabay Enhanced (12.7mm high)</p>		
EIDE controller	<p>Enhanced IDE, ATA-133, via EIDE bridge Silicon Image™ SIL3811 from ICH9</p>		
EIDE cables	<p>One cable (one 1-drop Ultrabay Enhanced cable to optical), one EIDE connector (Ultrabay Enhanced) on systemboard</p>		
Diskette drive	<p>None</p>		
Media reader	<p>None</p>		
Chipset	<p>Intel Q35 Express Chipset: I/O Controller Hub 9 (ICH9) for SATA 3.0Gb/s, PCI Express® x1, ethernet (MAC), PCI 2.3, USB, LPC bus / SMSC® SCH5617 Super I/O for serial, parallel, diskette, hardware monitoring (temperature, voltage, fan speed)</p>		
Front ports	<p>Two USB 2.0, microphone (stereo, 3.5mm), headphone (stereo, 3.5mm)</p>		
Rear ports	<p>Six USB 2.0, serial (9-pin), parallel (25-pin), ethernet (RJ-45), monitor (VGA DB-15), eSATA</p>		
Rear audio ports	<p>Line-in (stereo, 3.5mm), line-out (stereo, 3.5mm)</p>		
Audio	<p>High Definition (HD) Audio, Analog Devices AD1882 codec</p>		
Speaker	<p>One internal speaker for business audio</p>		
Ethernet	<p>Gigabit ethernet on planar, Intel 82566DM, PCIe x1, Wake on LAN®, ASF2.0</p>		
Intel AMT	<p>None</p>		
Modem	<p>None</p>		
Security chip	<p>Winbond® WPCT200 SafeKeeper™ Trusted Platform Module, TCG 1.2-compliant</p>		
Keyboard	<p>Preferred Pro USB Keyboard (USB connector), 104-key, black, Lenovo logo</p>		
Mouse	<p>Optical Wheel Mouse (USB connector), black, Lenovo logo</p>		
Power supply	<p>225 watts with variable speed fan, autosenesing, two diagnostic LEDs</p>		
Preloaded operating system²⁰	<p>Accessories</p>		
- <i>Some</i> : Microsoft® Windows® XP Professional with Vista® COA	1GB PC2-5300 CL5 NP DDR2 UDIMM	73P4984	
- <i>Some</i> : Microsoft Windows Vista Business Edition (32-bit)	2GB PC2-5300 CL5 NP DDR2 UDIMM	73P4985	
◇ <i>Vista models</i> : Vista Basic logo	1GB PC2-6400 NP DDR2 UDIMM	41U2977	
Preloaded applications⁵ (all OSes)	2GB PC2-6400 NP DDR2 UDIMM	41U2978	
• Rescue and Recovery™	250GB SATA 3.0Gb/s Disk (7200 rpm)	41N3015	
• Client Security Solution™	500GB SATA 3.0Gb/s Disk (7200 rpm)	43R1990	
• ThinkVantage Productivity Center	USB 2.0 Lenovo Multimedia Headset	40Y8518	
• ThinkVantage System Update	USB 2.0 Lenovo Webcam	40Y8519	
• System Migration Assistant	USB 2.0 Essential Memory Key 32GB	45K1258	
• Norton Internet Security™	USB 2.0 Ultra Secure Memory Key 2GB	45J5916	
• Diskeeper® Home	USB 2.0 Ultra Secure Memory Key 4GB	45J5917	
• PC-Doctor™ (diagnostics)	USB 2.0 Ultra Secure Memory Key 8GB	45J5918	
• Adobe® Reader	USB 2.0 Portable Secure 320GB Hard Disk	43R2019	
• Windows Live™ Toolbar	USB 2.0 Super Multi-Burner Drive	41N5565	
• Windows Live Search	ThinkVision® L1700p 17" Monitor	9417HE2	
• Picasa from Google	ThinkVision L1940p Wide 19" Monitor	4424HB6	
• Microsoft Office 2007 Trial (60-day)	ThinkVision L2240p Wide 22" Monitor	4422HB6	
• Multimedia Center for Think Offerings (combo) (XP)	ThinkVision L2440p Wide 24" Monitor	4420HB2	
• Sonic RecordNow and Drive Letter Access (combo)	ThinkCentre Ultra Small Under Desk Mount	40Y8625	
• Corel® WinDVD® (combo, DVD)	Wireless Kbd & Opt Wheel Mouse (via USB)	73P4067	
	USB Travel Keyboard with UltraNav™	31P9490	
	Laser Tilt Wheel Mouse (USB, PS/2)	41U3074	
	Kensington Cable Lock from Lenovo	73P2582	
	Acc Guide in pdf lenovo.com/accessoriesguide		
	Other accessories at lenovo.com/accessories		

See footnotes for important warranty information
 US models announced January 22, 2008
 ⚠ US models withdrawn effective September 2008

Name	Type-model	Slot x bay	Processor	GHz	L2 cache	Memory ⁹	SATA disk	EIDE optical	Graphics	eSATA port	Intel vPro	Preload	Limited warranty ¹	Global Educ	Avail date
M57	6071-E3U	1x2	Pentium E2200	2.20	1MB	1GB	160GB ²	DVD	GMA+ADD2	eSATA	No	XP Pro	3-yr	None	Sep 08
M57	6071-E4U	1x2	Pentium E2200	2.20	1MB	2GB	160GB	DVD±RW	GMA+ADD2	eSATA	No	XP Pro	3-yr	None	Sep 08
M57	6071-E5U	1x2	Core 2 Duo E7200	2.53	3MB	1GB	160GB	DVD±RW	GMA+ADD2	eSATA	No	XP Pro	3-yr	None	Sep 08
M57	6071-E7U	1x2	Core 2 Duo E7200	2.53	3MB	2GB	160GB	DVD	GMA+ADD2	eSATA	No	XP Pro	3-yr	None	Sep 08
M57	6071-E6U	1x2	Core 2 Duo E7300	2.66	3MB	2GB	250GB	DVD±RW	GMA+ADD2	eSATA	No	XP Pro	3-yr	None	Sep 08
M57	6071-E9U	1x2	Core 2 Duo E8400	3.00	6MB	1GB	160GB	DVD±RW	GMA+ADD2	eSATA	No	XP Pro	3-yr	None	Sep 08
M57	6071-E8U	1x2	Core 2 Duo E8400	3.00	6MB	2GB	160GB	DVD	GMA+ADD2	eSATA	No	XP Pro	3-yr	None	Sep 08
M57	6071-E1U	1x2	Core 2 Duo E7200	2.53	3MB	1GB	160GB	DVD	GMA+ADD2	eSATA	No	Bus32	3-yr	None	Sep 08
M57	6071-E2U	1x2	Core 2 Duo E7300	2.66	3MB	1GB	250GB	DVD±RW	GMA+ADD2	eSATA	No	Bus32	3-yr	None	Sep 08

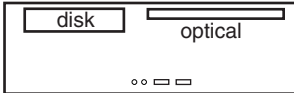
Positioning Processor	<i>Ultimate enterprise stability for large enterprise and mid-market</i> Intel® Pentium® Dual-Core Processor E2200 with dual-core , Intel 64 Technology, Execute Disable Bit, EIST, 800MHz system bus, and 1MB shared L2 cache or Intel Core™ 2 Duo Processor E7200 or E7300 with dual-core , Intel 64 Technology, Execute Disable Bit, EIST, 1066MHz system bus, and 3MB shared L2 cache or Intel Core 2 Duo Processor E8400 with dual-core , Intel 64 Technology, Virtualization Technology, Execute Disable Bit, EIST, TXT, and 1333MHz system bus with 6MB shared L2 cache Processor in FC-LGA6 or FC-LGA8 package in LGA775 socket	Ultra Small	
Implementation		Bay ① 3.5", 1" high, no access, std disk (desktop) Bay ② 5.25", *.5" high, access, std optical (notebook)	
Memory	1GB or 2GB std, 4GB max ⁸ , PC2-5300 667MHz DDR2 , non-parity, dual-channel capable, two 240-pin DIMM sockets; <i>Non-italics</i> : standard memory in one socket; one socket available	Slot 1: half-length (175mm), full-height, PCI Express x1 (via riser card; used by ADD2 DVI-D adapter)	
Graphics	Intel Graphics Media Accelerator 3100 (GMA 3100) , integrated graphics in Q35, uses main memory (up to 256MB), one analog VGA DB-15 connector ADD2 DVI-D Monitor Connection (HDCP) , PCI Express® adapter in PCIe x1 slot, provides DVI-D connector to support second monitor, HDCP-compliant	<ul style="list-style-type: none"> • Business black color; metal case • 10.9" W X 10.7" D X 3.5" H • 276mm W X 273mm D X 89mm H • 14.1 lb (6.4 kg) in maximum configuration • Toolless cover flips up and tilts backward on rear hinges • Toolless disk and optical drive removal • Bays 1 and 2 flip up (latched and pivoting) • PCI Express x1 slot on riser card (one 32-bit PCI 2.3 slot also on riser but not supported simultaneously) • Toolless adapter and riser card retention • Steel chassis supports 100 lb (45kg) monitor on top • System floor stand for vertical orientation 	
SATA disk	160GB or 250GB , SATA 3.0Gb/s 7200 rpm, vibration dampening		
SATA controller	Serial ATA, SATA 3.0Gb/s, integrated in ICH9		
SATA cables	One SATA cable (1-drop to disk), one SATA connector on planar		
eSATA port	One external SATA (eSATA) port		
EIDE DVD	<i>Some:</i> 8X/24X Max ⁴ DVD-ROM, Ultrabay Enhanced (12.7mm)		
EIDE DVD±RW	<i>Some:</i> Multi-Burner DL DVD±RW Drive, Ultrabay Enhanced (12.7mm high)		
EIDE controller	Enhanced IDE, ATA-133, via EIDE bridge Silicon Image™ SIL3811 from ICH9		
EIDE cables	One cable (one 1-drop Ultrabay Enhanced cable to optical), one EIDE connector (Ultrabay Enhanced) on systemboard		
Diskette drive	None		
Media reader	None		
Chipset	Intel Q35 Express Chipset ; I/O Controller Hub 9 (ICH9) for SATA 3.0Gb/s, PCI Express x1, ethernet (MAC), PCI 2.3, USB, LPC bus / SMSC® SCH5617 Super I/O for serial, parallel, diskette, hardware monitoring (temperature, voltage, fan speed)		
Front ports	Two USB 2.0, microphone (stereo, 3.5mm), headphone (stereo, 3.5mm)		
Rear ports	Six USB 2.0, serial (9-pin), parallel (25-pin), ethernet (RJ-45), monitor (VGA DB-15, DVI-D), eSATA		
Rear audio ports	Line-in (stereo, 3.5mm), line-out (stereo, 3.5mm)		
Audio	High Definition (HD) Audio, Analog Devices AD1882 codec		
Speaker	One internal speaker for business audio		
Ethernet	Gigabit ethernet on planar, Intel 82566DM, PCIe x1, Wake on LAN®, ASF2.0		
Intel AMT	None		
Modem	None		
Security chip	Winbond® WPCT200 SafeKeeper™ Trusted Platform Module, TCG 1.2-compliant		
Keyboard	Preferred Pro USB Keyboard (USB connector), 104-key, black, Lenovo logo		
Mouse	Optical Wheel Mouse (USB connector), black, Lenovo logo		
Power supply	225 watts with variable speed fan, autosensing, two diagnostic LEDs		
Preloaded operating system²⁰		Accessories	
- <i>Some:</i> Microsoft® Windows® XP Professional with Vista® COA		1GB PC2-5300 CL5 NP DDR2 UDIMM	73P4984
- <i>Some:</i> Microsoft Windows Vista Business Edition (32-bit)		2GB PC2-5300 CL5 NP DDR2 UDIMM	73P4985
◇ <i>Vista models:</i> Vista Premium logo		1GB PC2-6400 NP DDR2 UDIMM	41U2977
Preloaded applications⁵ (all OSes; only some listed)		2GB PC2-6400 NP DDR2 UDIMM	41U2978
• Rescue and Recovery™		500GB SATA 3.0Gb/s Disk (7200 rpm)	43R1990
• Client Security Solution™		USB 2.0 Lenovo Multimedia Headset	40Y8518
• ThinkVantage Productivity Center		USB 2.0 Lenovo Webcam	40Y8519
• Norton Internet Security™		USB 2.0 Ultra Secure Memory Key 8GB	45J5918
• Microsoft Office 2007 Trial (60-day)		USB 2.0 Portable Secure 320GB Hard Disk	43R2019
• Multimedia Center for Think Offerings (DVD, DVD±RW) (XP)		ThinkVision® L2240p Wide 22" Monitor	4422HB6
• Sonic RecordNow and Drive Letter Access (DVD±RW)		ThinkVision L2440p Wide 24" Monitor	4420HB2
• Corel® WinDVD® (DVD, DVD±RW)		ThinkCentre Ultra Small Under Desk Mount	40Y8625
• Corel WinDVD Creator (DVD±RW) (XP)		Wireless Kbd & Opt Wheel Mouse (via USB)	73P4067
		USB Travel Keyboard with UltraNav™	31P9490
		Laser Tilt Wheel Mouse (USB, PS/2)	41U3074
		Kensington Cable Lock from Lenovo	73P2582
		Acc Guide in pdf lenovo.com/accessoriesguide	
		Other accessories at lenovo.com/accessories	

Security	<ul style="list-style-type: none"> • Security chip (see information on left) • Security slot (in rear for attachment of optional Kensington® Microsaver® cable) - optional cable also locks the cover by deactivating the cover release buttons • Power-on password • Administrator password • Hard disk password • Boot sequence control • Boot without keyboard, mouse • Serial port I/O control • Parallel port I/O control • Individual USB port disablement • eSATA port disablement
	Supports ThinkVantage® technologies
	RoHS-compliant
	Limited Warranty¹
	<ul style="list-style-type: none"> ⇨ 3-year parts and labor ⇨ International Warranty Service⁹ ⇨ Customer Replaceable Unit (CRU) parts only (with limited onsite service for selected parts³, 8 am - 5 pm, Mon - Fri coverage excluding holidays, next business day response time) ⇨ Onsite service upgrade options (in eligible locations):⁷ <ul style="list-style-type: none"> • 3-year LOR 9x5, 4 hour response (ThinkPlus™ part number 41C9192) • 3-year LOR 24x7, 4 hour response (ThinkPlus part number 41C9193) • 4-year LOR 9x5, Next Business Day (ThinkPlus part number 41C9194) • 4-year LOR 9x5, 4 hour response (ThinkPlus part number 41C9195) • 4-year LOR 24x7, 4 hour response (ThinkPlus part number 41C9196) ⇨ ThinkPlus services at lenovo.com/thinkplus/warranty ⇨ 24 hour x 7 day¹⁴ toll-free support during the warranty period¹

See footnotes for important warranty information
US models announced August 19, 2008

Name	Type-model	Slot x bay	Processor	GHz	L2 cache	Memory ⁸	SATA disk	SATA optical	Graphics	eSATA port	Intel vPro	Preload	Vista logo	Limited warranty ¹	Global Educ	Avail date
M57	9970-A1U	2x3	Pentium E2200	2.20	1MB	1GB	160GB ²	DVD	GMA	eSATA	No	XP Pro		3-yr	No	Jun 08
M57	9970-A2U	2x3	Core 2 Duo E7200	2.53	3MB	1GB	160GB	DVD±RW	GMA	eSATA	No	XP Pro		3-yr	No	Jun 08
M57	9970-A3U	2x3	Core 2 Duo E8400	3.00	6MB	1GB	160GB	DVD±RW	GMA	eSATA	No	XP Pro		3-yr	No	Jun 08
M57	9970-A4U	2x3	Pentium E2200	2.20	1MB	1GB	160GB	DVD	GMA	eSATA	No	Bus32	Prem	3-yr	No	Aug 08
M57	9970-A5U	2x3	Core 2 Duo E7200	2.53	3MB	1GB	160GB	DVD±RW	GMA	eSATA	No	Bus32	Prem	3-yr	No	Aug 08

• These small and medium business (SMB) models are part of the US TopSeller™ Program

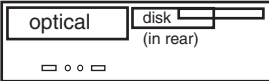
Positioning Processor	<p>Ultimate stability for small and medium businesses</p> <p>Intel® Pentium® Dual-Core Processor E2200 with dual-core, Intel 64 Technology, Execute Disable Bit, EIST, 800MHz system bus, and 1MB shared L2 cache or Intel Core™ 2 Duo Processor E7200 with dual-core, Intel 64 Technology, Execute Disable Bit, EIST, 1066MHz system bus, and 3MB shared L2 cache or Intel Core 2 Duo Processor E8400 with dual-core, Intel 64 Technology, Virtualization Technology, Execute Disable Bit, EIST, TXT, and 1333MHz system bus with 6MB shared L2 cache Processor in FC-LGA6 or FC-LGA8 package in LGA775 socket</p>	<p>Small</p>  <p>Bay ① 5.25", 1.6" high, access, std optical Bay ② 3.5", 1" high, no access, std disk Bay ③ 3.5", .5" high, access, open (reader/diskette)</p> <p>Slot 1: Low Profile, PCI Express x16 (35w max) Slot 2: Low Profile, 32-bit PCI 2.3 (5v)</p> <ul style="list-style-type: none"> • Business black color; metal case • 12.5" W X 13.4" D X 3.9" H • 317mm W X 341mm D X 99mm H • 16.4 lb (7.4 kg) in maximum configuration • Bays 1, 2, 3 flip up (latched and pivoting) • Toolless cover flips up and tilts backward on rear hinges • Toolless disk, optical drive removal • Toolless adapter retention • Toolless systemboard retention • Steel chassis supports 100 lb (45kg) monitor on top • System floor stand for vertical orientation
Implementation	<p>1GB std, 8GB max⁸, PC2-5300 667MHz DDR2, non-parity, dual-channel capable, four 240-pin DIMM sockets; <i>Non-italics:</i> standard memory in one socket; 3 sockets available</p>	
Memory	<p>Intel Graphics Media Accelerator 3100 (GMA 3100), integrated graphics in Q35, uses main memory (up to 256MB), one analog VGA DB-15 connector, supports dual independent display with optional ADD2 adapter</p>	
Graphics	<p>160GB, SATA 3.0Gb/s 7200 rpm, vibration dampening mounts Serial ATA, SATA 3.0Gb/s, integrated in ICH9DO, RAID 0/1 support <i>Some:</i> DVD-ROM DL SATA 1.5Gb/s 16-48X Max⁴ Drive (41N5618) <i>Some:</i> Super Multi-Burner DL DVD±RW SATA 1.5Gb/s Drive (41N5620) Two SATA cables (each 1-drop to device), two SATA connectors on planar</p> <p>One external SATA (eSATA) port</p> <p>None</p> <p>None</p> <p>None</p>	<p>Security</p> <ul style="list-style-type: none"> • Security chip (see information on left) • Security slot (in rear for attachment of optional Kensington® Microsaver® cable) - optional cable also locks the cover by deactivating the cover release buttons • Power-on password • Administrator password • Hard disk password • Boot sequence control • Boot without keyboard, mouse • Serial port I/O control • Parallel port I/O control • Individual USB port disablement • eSATA port disablement <p>Supports ThinkVantage® technologies</p> <p>RoHS-compliant</p> <p>Limited Warranty¹</p> <ul style="list-style-type: none"> ↪ 3-year parts and labor ↪ International Warranty Service⁹ ↪ Customer Replaceable Unit (CRU) parts only (with limited onsite service for selected parts³, 8 am - 5 pm, Mon - Fri coverage excluding holidays, next business day response time) ↪ Onsite service upgrade options (in eligible locations):⁷ <ul style="list-style-type: none"> • 3-year LOR 9x5, 4 hour response (ThinkPlus™ part number 41C9192) • 3-year LOR 24x7, 4 hour response (ThinkPlus part number 41C9193) • 4-year LOR 9x5, Next Business Day (ThinkPlus part number 41C9194) • 4-year LOR 9x5, 4 hour response (ThinkPlus part number 41C9195) • 4-year LOR 24x7, 4 hour response (ThinkPlus part number 41C9196) ↪ ThinkPlus services at lenovo.com/thinkplus/warranty ↪ Post warranty maintenance services available ↪ 24 hour x 7 day¹⁴ toll-free support during the warranty period¹ via 800-426-7378
SATA disk	<p>Intel Q35 Express Chipset; I/O Controller Hub 9 Digital Office (ICH9DO) for SATA 3.0Gb/s with RAID 0/1 support, PCI Express® x1, ethernet (MAC), PCI 2.3, USB, LPC bus / SMSC® SCH5617 Super I/O for serial, parallel, diskette, hardware monitoring (temperature, voltage, fan speed)</p>	
SATA controller	<p>Two SATA cables (each 1-drop to device), two SATA connectors on planar</p>	
SATA DVD	<p>One external SATA (eSATA) port</p>	
SATA DVD±RW	<p>None</p>	
SATA cables	<p>None</p>	
eSATA port	<p>None</p>	
EIDE controller	<p>None</p>	
Diskette drive	<p>None</p>	
Media reader	<p>None</p>	
Chipset	<p>Two USB 2.0, microphone (stereo, 3.5mm), headphone (stereo, 3.5mm)</p> <p>Six USB 2.0, serial (9-pin), parallel (25-pin), ethernet (RJ-45), monitor (VGA DB-15), eSATA</p> <p>Two USB 2.0 planar conn (1 used; one open for media reader or 2 rear USB ports)</p> <p>Line-in (stereo, 3.5mm), line-out (stereo, 3.5mm), microphone-in (stereo, 3.5mm)</p> <p>High Definition (HD) Audio, Analog Devices AD1882 codec</p> <p>One internal speaker for business audio</p> <p>Gigabit ethernet on planar, Intel 82566DM, PCIe x1, Wake on LAN®, ASF2.0</p> <p>None</p> <p>None</p> <p>Winbond® WPCT200 SafeKeeper™ Trusted Platform Module, TCG 1.2-compliant</p>	
Front ports	<p>Preferred Pro USB Keyboard (USB connector), 104-key, black, Lenovo logo</p> <p>Optical Wheel Mouse (USB connector), black, Lenovo logo</p> <p>280 watts with variable speed fan, autosensing, two diagnostic LEDs</p>	
Rear ports		
Internal connector		
Rear audio ports		
Audio		
Speaker		
Ethernet		
Intel AMT		
Modem		
Security chip		
Keyboard		
Mouse		
Power supply		
Preloaded operating system ²⁰	<p>Accessories</p> <p>1GB PC2-5300 CL5 NP DDR2 UDIMM 73P4984</p> <p>2GB PC2-5300 CL5 NP DDR2 UDIMM 73P4985</p> <p>1GB PC2-6400 NP DDR2 UDIMM 41U2977</p> <p>2GB PC2-6400 NP DDR2 UDIMM 41U2978</p> <p>250GB SATA 3.0Gb/s Disk (7200 rpm) 41N3015</p> <p>500GB SATA 3.0Gb/s Disk (7200 rpm) 43R1990</p> <p>USB 2.0 Lenovo Multimedia Headset 40Y8518</p> <p>USB 2.0 Lenovo Webcam 40Y8519</p> <p>USB 2.0 Essential Memory Key 32GB 45K1258</p> <p>USB 2.0 Ultra Secure Memory Key 8GB 45J5918</p> <p>USB 2.0 Portable 160GB Hard Disk 43R1784</p> <p>USB 2.0 Portable Secure 320GB Hard Disk 43R2019</p> <p>USB 2.0 Super Multi-Burner Drive 41N5565</p> <p>ThinkVision® L1940p Wide 19" Monitor 4424HB6</p> <p>ThinkVision L2240p Wide 22" Monitor 4422HB6</p> <p>ThinkVision L2440p Wide 24" Monitor 4420HB2</p> <p>Wireless Kbd & Opt Wheel Mouse (via USB) 73P4067</p> <p>Laser Tilt Wheel Mouse (USB, PS/2) 41U3074</p> <p>Kensington Cable Lock from Lenovo 73P2582</p> <p>ADD2 DVI-D Monitor Connection (HDCP) 43R1985</p> <p>ATI™ Radeon™ HD 2400 Pro 128MB 43R1961</p> <p>ATI Radeon HD 2400 XT 256MB 43R1962</p> <p>Acc Guide in pdf lenovo.com/accessoriesguide</p> <p>Other accessories at lenovo.com/accessories</p>	
- Some: Microsoft® Windows® XP Professional with Vista® COA		
- Some: Microsoft Windows Vista Business Edition (32-bit)		
Preloaded applications ⁵ (all OSes)		
• Rescue and Recovery™		
• Client Security Solution™		
• ThinkVantage Productivity Center		
• ThinkVantage System Update		
• System Migration Assistant		
• Norton Internet Security™		
• Diskeeper® Home		
• PC-Doctor™ (diagnostics)		
• Adobe® Reader		
• Windows Live™ Toolbar		
• Windows Live Search		
• Picasa from Google		
• Microsoft Office 2007 Trial (60-day)		
• Multimedia Center for Think Offerings (DVD, DVD±RW) (XP)		
• Sonic RecordNow and Drive Letter Access (DVD±RW)		
• Corel® WinDVD® (DVD, DVD±RW)		
• Corel WinDVD Creator (DVD±RW) (XP)		

See footnotes for important warranty information

US models announced August 19, 2008; previous models on June 24, 2008

Name	Type-model	Slot x bay	Processor	GHz	L2 cache	Memory ^a	SATA disk	SATA optical	Graphics	eSATA port	Intel vPro	Floor stand	Preload	Global Educ	Avail date
M57	6072-C2U	2x3	Pentium E2140	1.60	1MB	1GB	80GB ²	DVD	GMA	eSATA	None	Stand	XP Pro		Oct 07
M57	6072-C3U	2x3	Pentium E2140	1.60	1MB	1GB	80GB	Combo	GMA	eSATA	None	Stand	XP Pro		Oct 07
M57	6072-ENU	2x3	Pentium E2160	1.80	1MB	1GB	160GB	DVD	GMA	eSATA	None	Stand	XP Pro	Gbl	Dec 07
M57	6072-C1U	2x3	Core 2 Duo E4400	2.00	2MB	1GB	80GB	DVD	GMA	eSATA	None	Stand	XP Pro		Oct 07
M57	6072-EPU	2x3	Core 2 Duo E4500	2.20	2MB	1GB	160GB	DVD	GMA	eSATA	None	Stand	XP Pro	Gbl	Dec 07
M57	6072-BJU	2x3	Pentium E2160	1.80	1MB	1GB	80GB	DVD	GMA	eSATA	None	Stand	Bus32	Gbl	Nov 07
M57	6072-BKU	2x3	Pentium E2160	1.80	1MB	1GB	80GB	Combo	GMA	eSATA	None	Stand	Bus32		Oct 07
M57	6072-BMU	2x3	Pentium E2160	1.80	1MB	1GB	160GB	DVD±RW	GMA	eSATA	None	Stand	Bus32		Oct 07
M57	6072-ERU	2x3	Pentium E2160	1.80	1MB	1GB	160GB	DVD±RW	GMA	eSATA	None	Stand	Bus32	Gbl	Dec 07
M57	6072-A4U	2x3	Core 2 Duo E4400	2.00	2MB	1GB	80GB	DVD	GMA	eSATA	None	Stand	Bus32		Oct 07
M57	6072-BNU	2x3	Core 2 Duo E4400	2.00	2MB	1GB	80GB	Combo	GMA	eSATA	None	Stand	Bus32		Oct 07
M57	6072-AJU	2x3	Core 2 Duo E4400	2.00	2MB	1GB	160GB	DVD±RW	GMA	eSATA	None	Stand	Bus32		Oct 07
M57	6072-ATU	2x3	Core 2 Duo E6550	2.33	4MB	1GB	80GB	DVD	GMA	eSATA	None	Stand	Bus32		Oct 07
M57	6072-BVU	2x3	Core 2 Duo E6550	2.33	4MB	1GB	80GB	DVD	GMA	eSATA	None	Stand	Bus32	Gbl	Oct 07
M57	6072-A5U	2x3	Core 2 Duo E6550	2.33	4MB	1GB	80GB	Combo	GMA	eSATA	None	Stand	Bus32	Gbl	Oct 07
M57	6072-ASU	2x3	Core 2 Duo E6550	2.33	4MB	1GB	160GB	DVD±RW	GMA	eSATA	None	Stand	Bus32		Oct 07
M57	6072-EQU	2x3	Core 2 Duo E6550	2.33	4MB	1GB	160GB	DVD±RW	GMA	eSATA	None	Stand	Bus32	Gbl	Dec 07

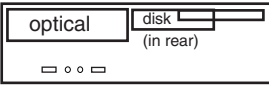
Positioning Processor	<p><i>Ultimate enterprise stability for large enterprise and mid-market</i></p> <p>Intel® Pentium® Dual-Core Processor E2140 or E2160 with dual-core, Intel 64 Technology, Execute Disable Bit, EIST, 800MHz system bus, and 1MB shared L2 cache or Intel Core™ 2 Duo Processor E4400 or E4500 with dual-core, Intel 64 Technology, Execute Disable Bit, EIST, 800MHz system bus, and 2MB shared L2 cache or Intel Core 2 Duo Processor E6550 with dual-core, Intel 64 Technology, Virtualization Technology, Execute Disable Bit, EIST, TXT, and 1333MHz system bus with 4MB shared L2 cache</p>	<p>Small</p>  <p>Bay ① 5.25", 1.6" high, access, std optical Bay ② 3.5", 1" high, no access, std disk Bay ③ 3.5", .5" high, access, open (reader/diskette)</p> <p>Slot 1: Low Profile, PCI Express x16 (35w max) Slot 2: Low Profile, 32-bit PCI 2.3 (5v)</p> <ul style="list-style-type: none"> • Business black color; metal case • 12.5" W X 13.4" D X 3.9" H • 317mm W X 341mm D X 99mm H • 16.4 lb (7.4 kg) in maximum configuration • Bays 1, 2, 3 flip up (latched and pivoting) • Toolless cover flips up and tilts backward on rear hinges • Toolless disk, optical drive removal • Toolless adapter retention • Toolless systemboard retention • Steel chassis supports 100 lb (45kg) monitor on top • <i>Some:</i> system floor stand for vertical orientation 																						
Implementation	Processor in FC-LGA6 package in LGA775 socket																							
Memory	<p>1GB std, 8GB max⁸, PC2-5300 667MHz DDR2, non-parity, dual-channel capable, four 240-pin DIMM sockets; <i>Non-italics:</i> standard memory in one socket; 3 sockets available</p>																							
Graphics	<p>Intel Graphics Media Accelerator 3100 (GMA 3100), integrated graphics in Q35, uses main memory (up to 256MB), one analog VGA DB-15 connector, supports dual independent display with optional ADD2 adapter</p>																							
SATA disk	<p>80GB or 160GB, SATA 3.0Gb/s 7200 rpm, vibration dampening</p>																							
SATA controller	Serial ATA, SATA 3.0Gb/s, integrated in ICH9DO, RAID 0/1 support																							
SATA DVD	<i>Some:</i> DVD-ROM DL SATA 1.5Gb/s 16-48X Max ⁴ Drive (41N5618)																							
SATA Combo	<i>Some:</i> CD-RW/DVD-ROM Combo SATA 1.5Gb/s Drive																							
SATA DVD±RW	<i>Some:</i> Super Multi-Burner DL DVD±RW SATA 1.5Gb/s Drive (41N5620)																							
SATA cables	Two SATA cables (each 1-drop to device), two SATA connectors on planar																							
eSATA port	One external SATA (eSATA) port																							
EIDE controller	None																							
Diskette drive	None																							
Media reader	None																							
Chipset	<p>Intel Q35 Express Chipset; I/O Controller Hub 9 Digital Office (ICH9DO) for SATA 3.0Gb/s with RAID 0/1 support, PCI Express[®] x1, ethernet (MAC), PCI 2.3, USB, LPC bus / SMSC[®] SCH5617 Super I/O for serial, parallel, diskette, hardware monitoring (temperature, voltage, fan speed)</p>	<p>Security</p> <ul style="list-style-type: none"> • Security chip (see information on left) • Security slot (in rear for attachment of optional Kensington[®] Microsaver[®] cable) - optional cable also locks the cover by deactivating the cover release buttons • Power-on password • Administrator password • Hard disk password • Boot sequence control • Boot without keyboard, mouse • Serial port I/O control • Parallel port I/O control • Individual USB port disablement • eSATA port disablement 																						
Front ports	Two USB 2.0, microphone (stereo, 3.5mm), headphone (stereo, 3.5mm)																							
Rear ports	Six USB 2.0, serial (9-pin), parallel (25-pin), ethernet (RJ-45), monitor (VGA DB-15), eSATA																							
Internal connector	Two USB 2.0 planar conn (1 used; one open for media reader or 2 rear USB ports)																							
Rear audio ports	Line-in (stereo, 3.5mm), line-out (stereo, 3.5mm), microphone-in (stereo, 3.5mm)																							
Audio	High Definition (HD) Audio, Analog Devices AD1882 codec																							
Speaker	One internal speaker for business audio																							
Ethernet	Gigabit ethernet on planar, Intel 82566DM, PCIe x1, Wake on LAN [®] , ASF2.0																							
Intel AMT	None																							
Modem	None																							
Security chip	Winbond [®] WPCT200 SafeKeeper [™] Trusted Platform Module, TCG 1.2-compliant																							
Keyboard	Preferred Pro USB Keyboard (USB connector), 104-key, black, Lenovo logo																							
Mouse	Optical Wheel Mouse (USB connector), black, Lenovo logo																							
Power supply	280 watts with variable speed fan, autosensing, two diagnostic LEDs																							
Preloaded operating system²⁰	<p>- <i>Some:</i> Microsoft[®] Windows[®] XP Professional with Vista[®] COA</p> <p>- <i>Some:</i> Microsoft Windows Vista Business Edition (32-bit)</p> <p>⚡ <i>Vista models:</i> Vista Basic logo</p>	<p>Accessories</p> <table border="0"> <tr> <td>1GB PC2-5300 CL5 NP DDR2 UDIMM</td> <td>73P4984</td> </tr> <tr> <td>2GB PC2-5300 CL5 NP DDR2 UDIMM</td> <td>73P4985</td> </tr> <tr> <td>1GB PC2-6400 NP DDR2 UDIMM</td> <td>41U2977</td> </tr> <tr> <td>2GB PC2-6400 NP DDR2 UDIMM</td> <td>41U2978</td> </tr> <tr> <td>500GB SATA 3.0Gb/s Disk (7200 rpm)</td> <td>43R1990</td> </tr> <tr> <td>USB 2.0 Lenovo Multimedia Headset</td> <td>40Y8518</td> </tr> <tr> <td>USB 2.0 Ultra Secure Memory Key 8GB</td> <td>45J5918</td> </tr> <tr> <td>ThinkVision[®] L2440p Wide 24" Monitor</td> <td>4420HB2</td> </tr> <tr> <td>ADD2 DVI-D Monitor Connection (HDCP)</td> <td>43R1985</td> </tr> <tr> <td>ATI[™] Radeon[™] HD 2400 Pro 128MB</td> <td>43R1961</td> </tr> <tr> <td>ATI Radeon HD 2400 XT 256MB</td> <td>43R1962</td> </tr> </table> <p>Other accessories at lenovo.com/accessories</p>	1GB PC2-5300 CL5 NP DDR2 UDIMM	73P4984	2GB PC2-5300 CL5 NP DDR2 UDIMM	73P4985	1GB PC2-6400 NP DDR2 UDIMM	41U2977	2GB PC2-6400 NP DDR2 UDIMM	41U2978	500GB SATA 3.0Gb/s Disk (7200 rpm)	43R1990	USB 2.0 Lenovo Multimedia Headset	40Y8518	USB 2.0 Ultra Secure Memory Key 8GB	45J5918	ThinkVision [®] L2440p Wide 24" Monitor	4420HB2	ADD2 DVI-D Monitor Connection (HDCP)	43R1985	ATI [™] Radeon [™] HD 2400 Pro 128MB	43R1961	ATI Radeon HD 2400 XT 256MB	43R1962
1GB PC2-5300 CL5 NP DDR2 UDIMM	73P4984																							
2GB PC2-5300 CL5 NP DDR2 UDIMM	73P4985																							
1GB PC2-6400 NP DDR2 UDIMM	41U2977																							
2GB PC2-6400 NP DDR2 UDIMM	41U2978																							
500GB SATA 3.0Gb/s Disk (7200 rpm)	43R1990																							
USB 2.0 Lenovo Multimedia Headset	40Y8518																							
USB 2.0 Ultra Secure Memory Key 8GB	45J5918																							
ThinkVision [®] L2440p Wide 24" Monitor	4420HB2																							
ADD2 DVI-D Monitor Connection (HDCP)	43R1985																							
ATI [™] Radeon [™] HD 2400 Pro 128MB	43R1961																							
ATI Radeon HD 2400 XT 256MB	43R1962																							
Preloaded applications⁵ (all OSes; only some listed)	<ul style="list-style-type: none"> • Rescue and Recovery[™] • Client Security Solution[™] • ThinkVantage Productivity Center • Norton Internet Security[™] • Microsoft Office 2007 Trial (60-day) 	<p>Supports ThinkVantage[®] technologies</p> <p>RoHS-compliant</p> <p>Limited Warranty¹</p> <ul style="list-style-type: none"> ⚡ 3-year parts and labor ⚡ Customer Replaceable Unit (CRU) parts only (with limited onsite service for selected parts³, 8 am - 5 pm, Mon - Fri coverage excluding holidays, next business day response time) ⚡ Onsite service upgrade options (in eligible locations):⁷ <ul style="list-style-type: none"> • 3-year LOR 24x7, 4 hour response (ThinkPlus part number 41C9193) • 4-year LOR 9x5, Next Business Day (ThinkPlus part number 41C9194) • 4-year LOR 24x7, 4 hour response (ThinkPlus part number 41C9196) ⚡ Other ThinkPlus services at lenovo.com/thinkplus/warranty ⚡ 24 hour x 7 day¹⁴ toll-free support during the warranty period¹ via 800-426-7378 																						

See footnotes for important warranty information

¹⁴ US models announced December 4, 2007; previous models on September 18 or October 16, 2007

⁸ US models withdrawn effective June or September 2008

Name	Type-model	Slot x bay	Processor	GHz	L2 cache	Memory ⁸	SATA disk	SATA optical	Graphics	eSATA port	Intel vPro	Preload	Limited warranty ¹	Global Educ	Avail date	
☞	M57	6072-FMU	2x3	Core 2 Duo E4500	2.20	2MB	1GB	160GB ²	DVD	GMA	eSATA	None	XP Pro	3-yr	None	Feb 08
	M57	6072-DNU	2x3	Core 2 Duo E8200	2.66	6MB	1GB	160GB	Combo	GMA	eSATA	None	XP Pro	3-yr	None	Feb 08
☞	M57	6072-FJU	2x3	Core 2 Duo E4500	2.20	2MB	1GB	160GB	DVD	GMA	eSATA	None	Bus32	3-yr	None	Feb 08
☞	M57	6072-FKU	2x3	Core 2 Duo E4500	2.20	2MB	1GB	160GB	Combo	GMA	eSATA	None	Bus32	3-yr	None	Feb 08
☞	M57	6072-FLU	2x3	Core 2 Duo E4500	2.20	2MB	1GB	160GB	DVD±RW	GMA	eSATA	None	Bus32	3-yr	None	Feb 08
	M57	6072-DMU	2x3	Core 2 Duo E8200	2.66	6MB	1GB	160GB	Combo	GMA	eSATA	None	Bus32	3-yr	None	Feb 08

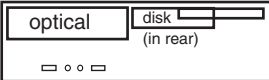
Positioning Processor	<i>Ultimate enterprise stability for large enterprise and mid-market</i> Intel® Core™ 2 Duo Processor E4500 with dual-core, Intel 64 Technology, Execute Disable Bit, EIST, 800MHz system bus, and 2MB shared L2 cache or Intel Core 2 Duo Processor E8200 with dual-core, Intel 64 Technology, Virtualization Technology, Execute Disable Bit, EIST, TXT, and 1333MHz system bus with 6MB shared L2 cache Processor in FC-LGA6 or FC-LGA8 package in LGA775 socket										Small	
Implementation	Processor in FC-LGA6 or FC-LGA8 package in LGA775 socket										Bay ① 5.25", 1.6" high, access, std optical Bay ② 3.5", 1" high, no access, std disk Bay ③ 3.5", .5" high, access, open (reader/diskette)	
Memory	1GB std , 8GB max ⁸ , PC2-5300 667MHz DDR2 , non-parity, dual-channel capable, four 240-pin DIMM sockets; <i>Non-italics</i> : standard memory in one socket; 3 sockets available										Slot 1: Low Profile, PCI Express x16 (35w max) Slot 2: Low Profile, 32-bit PCI 2.3 (5v)	
Graphics	Intel Graphics Media Accelerator 3100 (GMA 3100) , integrated graphics in Q35, uses main memory (up to 256MB), one analog VGA DB-15 connector, supports dual independent display with optional ADD2 adapter										<ul style="list-style-type: none"> • Business black color; metal case • 12.5" W X 13.4" D X 3.9" H • 317mm W X 341mm D X 99mm H • 16.4 lb (7.4 kg) in maximum configuration • Bays 1, 2, 3 flip up (latched and pivoting) • Toolless cover flips up and tilts backward on rear hinges • Toolless disk, optical drive removal • Toolless adapter retention • Toolless systemboard retention • Steel chassis supports 100 lb (45kg) monitor on top • System floor stand for vertical orientation 	
SATA disk	160GB , SATA 3.0Gb/s 7200 rpm, vibration dampening mounts										<p style="text-align: center;">Security</p> <ul style="list-style-type: none"> • Security chip (see information on left) • Security slot (in rear for attachment of optional Kensington® Microsaver® cable) - optional cable also locks the cover by deactivating the cover release buttons • Power-on password • Administrator password • Hard disk password • Boot sequence control • Boot without keyboard, mouse • Serial port I/O control • Parallel port I/O control • Individual USB port disablement • eSATA port disablement 	
SATA controller	Serial ATA, SATA 3.0Gb/s, integrated in ICH9DO, RAID 0/1 support											
SATA DVD	<i>Some</i> : DVD-ROM DL SATA 1.5Gb/s 16-48X Max ⁴ Drive (41N5618)											
SATA Combo	<i>Some</i> : CD-RW/DVD-ROM Combo SATA 1.5Gb/s Drive											
SATA DVD±RW	<i>Some</i> : Super Multi-Burner DL DVD±RW SATA Drive (41N5620)											
SATA cables	Two SATA cables (each 1-drop to device), two SATA connectors on planar											
eSATA port	One external SATA (eSATA) port											
EIDE controller	None											
Diskette drive	None											
Media reader	None											
Chipset	Intel Q35 Express Chipset ; I/O Controller Hub 9 Digital Office (ICH9DO) for SATA 3.0Gb/s with RAID 0/1 support, PCI Express [®] x1, ethernet (MAC), PCI 2.3, USB, LPC bus / SMSC[®] SCH5617 Super I/O for serial, parallel, diskette, hardware monitoring (temperature, voltage, fan speed)											
Front ports	Two USB 2.0, microphone (stereo, 3.5mm), headphone (stereo, 3.5mm)											
Rear ports	Six USB 2.0, serial (9-pin), parallel (25-pin), ethernet (RJ-45), monitor (VGA DB-15), eSATA											
Internal connector	Two USB 2.0 planar conn (1 used; one open for media reader or 2 rear USB ports)											
Rear audio ports	Line-in (stereo, 3.5mm), line-out (stereo, 3.5mm), microphone-in (stereo, 3.5mm)											
Audio	High Definition (HD) Audio, Analog Devices AD1882 codec											
Speaker	One internal speaker for business audio											
Ethernet	Gigabit ethernet on planar, Intel 82566DM, PCIe x1, Wake on LAN [®] , ASF2.0											
Intel AMT	None											
Modem	None											
Security chip	Winbond [®] WPCT200 SafeKeeper™ Trusted Platform Module, TCG 1.2-compliant										Supports ThinkVantage [®] technologies	
Keyboard	Preferred Pro USB Keyboard (USB connector), 104-key, black, Lenovo logo										RoHS-compliant	
Mouse	Optical Wheel Mouse (USB connector), black, Lenovo logo											
Power supply	280 watts with variable speed fan, autosensing, two diagnostic LEDs											
Preloaded operating system²⁰	Accessories											
- <i>Some</i> : Microsoft® Windows® XP Professional with Vista® COA	1GB PC2-5300 CL5 NP DDR2 UDIMM 73P4984											
- <i>Some</i> : Microsoft Windows Vista Business Edition (32-bit)	2GB PC2-5300 CL5 NP DDR2 UDIMM 73P4985											
◆ <i>Vista models</i> : Vista Basic logo	1GB PC2-6400 NP DDR2 UDIMM 41U2977											
Preloaded applications⁵ (all OSes; only some listed)	2GB PC2-6400 NP DDR2 UDIMM 41U2978											
• Rescue and Recovery™	250GB SATA 3.0Gb/s Disk (7200 rpm) 41N3015											
• Client Security Solution™	500GB SATA 3.0Gb/s Disk (7200 rpm) 43R1990											
• ThinkVantage Productivity Center	USB 2.0 Lenovo Multimedia Headset 40Y8518											
• ThinkVantage System Update	USB 2.0 Lenovo Webcam 40Y8519											
• System Migration Assistant	USB 2.0 Essential Memory Key 32GB 45K1258											
• Norton Internet Security™	USB 2.0 Ultra Secure Memory Key 8GB 45J5918											
• Diskeeper® Home	USB 2.0 Portable 160GB Hard Disk 43R1784											
• PC-Doctor™ (diagnostics)	USB 2.0 Portable Secure 320GB Hard Disk 43R2019											
• Adobe® Reader	USB 2.0 Super Multi-Burner Drive 41N5565											
• Picasa from Google	ThinkVision® L1940p Wide 19" Monitor 4424HB6											
• Microsoft Office 2007 Trial (60-day)	ThinkVision L2240p Wide 22" Monitor 4422HB6											
• Multimedia Center for Think Offerings (combo, DVD) (XP)	ThinkVision L2440p Wide 24" Monitor 4420HB2											
• Sonic RecordNow and Drive Letter Access (combo, DVD±RW)	Wireless Kbd & Opt Wheel Mouse (via USB) 73P4067											
• Corel® WinDVD® (combo, DVD, DVD±RW)	Kensington Cable Lock from Lenovo 73P2582											
	ADD2 DVI-D Monitor Connection (HDCP) 43R1985											
	ATI™ Radeon™ HD 2400 Pro 128MB 43R1961											
	ATI Radeon HD 2400 XT 256MB 43R1962											
	Acc Guide in pdf lenovo.com/accessoriesguide											
	Other accessories at lenovo.com/accessories											
											<p>↪ 3-year parts and labor</p> <p>↪ International Warranty Service⁹</p> <p>↪ Customer Replaceable Unit (CRU) parts only (with limited onsite service for selected parts³, 8 am - 5 pm, Mon - Fri coverage excluding holidays, next business day response time)</p> <p>↪ Onsite service upgrade options (in eligible locations):⁷</p> <ul style="list-style-type: none"> • 3-year LOR 9x5, 4 hour response (ThinkPlus™ part number 41C9192) • 3-year LOR 24x7, 4 hour response (ThinkPlus part number 41C9193) • 4-year LOR 9x5, Next Business Day (ThinkPlus part number 41C9194) • 4-year LOR 9x5, 4 hour response (ThinkPlus part number 41C9195) • 4-year LOR 24x7, 4 hour response (ThinkPlus part number 41C9196) <p>↪ ThinkPlus services at lenovo.com/thinkplus/warranty</p> <p>↪ Post warranty maintenance services available</p> <p>↪ 24 hour x 7 day¹⁴ toll-free support during the warranty period¹ via 800-426-7378</p>	

See footnotes for important warranty information
US models announced January 22, 2008
☞ US models withdrawn effective September 2008

Name	Type-model	Slot x bay	Processor	GHz	L2 cache	Memory ⁸	SATA disk	SATA optical	Graphics	eSATA port	Intel vPro	Preload	Limited warranty ¹	Global Educ	Avail date
M57	6072-GUU	2x3	Pentium E2200	2.20	1MB	1GB	160GB ²	DVD	GMA	eSATA	No	XP Pro	3-yr	No	Aug 08
M57	6072-GVU	2x3	Pentium E2200	2.20	1MB	2GB	160GB	DVD±RW	GMA+ADD2	eSATA	No	XP Pro	3-yr	No	Aug 08
M57	6072-GWU	2x3	Core 2 Duo E7200	2.53	3MB	1GB	160GB	DVD±RW	GMA+ADD2	eSATA	No	XP Pro	3-yr	No	Aug 08
M57	6072-H2U	2x3	Core 2 Duo E7200	2.53	3MB	2GB	250GB	DVD	GMA	eSATA	No	XP Pro	3-yr	No	Aug 08
M57	6072-H1U	2x3	Core 2 Duo E7300	2.66	3MB	2GB	250GB	DVD±RW	GMA	eSATA	No	XP Pro	3-yr	No	Aug 08
M57	6072-H3U	2x3	Core 2 Duo E8400	3.00	6MB	1GB	160GB	DVD	GMA	eSATA	No	XP Pro	3-yr	No	Aug 08
M57	6072-H4U	2x3	Core 2 Duo E8400	3.00	6MB	2GB	160GB	DVD±RW	GMA+ADD2	eSATA	No	XP Pro	3-yr	No	Aug 08
M57	6072-H5U	2x3	Core 2 Duo E8400	3.00	6MB	2GB	250GB	DVD±RW	GMA	eSATA	No	XP Pro	3-yr	No	Aug 08
M57	6072-H6U	2x3	Core 2 Quad Q9300	2.50	6MB	2GB	250GB	DVD±RW	GMA+ADD2	eSATA	No	XP Pro	3-yr	No	Aug 08
M57	6072-H7U	2x3	Core 2 Quad Q9300	2.50	6MB	2GB	320GB	DVD±RW	2400XT	eSATA	No	XP Pro	3-yr	No	Aug 08

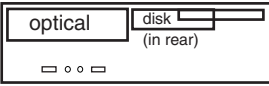
Positioning	<i>Ultimate enterprise stability for large enterprise and mid-market</i>	
Processor	<p>Intel® Pentium® Dual-Core Processor E2200 with dual-core, Intel 64 Technology, Execute Disable Bit, EIST, 800MHz system bus, and 1MB shared L2 cache or</p> <p>Intel Core™ 2 Duo Processor E7200 or E7300 with dual-core, Intel 64 Technology, Execute Disable Bit, EIST, 1066MHz system bus, and 3MB shared L2 cache or</p> <p>Intel Core 2 Duo Processor E8400 with dual-core, Intel 64 Technology, Virtualization Technology, Execute Disable Bit, EIST, TXT, 1333MHz system bus, and 6MB shared L2 cache or</p> <p>Intel Core 2 Quad Processor Q9300 with quad-core (dual-core on dual-die), Intel 64 Technology, Virtualization Technology, Execute Disable Bit, EIST, TXT, and 1333MHz system bus with 6MB shared L2 cache</p>	<p>Small</p>  <p>Bay ① 5.25", 1.6" high, access, std optical</p> <p>Bay ② 3.5", 1" high, no access, std disk</p> <p>Bay ③ 3.5", .5" high, access, open (reader/diskette)</p> <p>Slot 1: Low Profile, PCI Express x16 (35w max)*</p> <p>Slot 2: Low Profile, 32-bit PCI 2.3 (5v)</p> <p>* used in some models</p> <ul style="list-style-type: none"> • Business black color; metal case • 12.5" W X 13.4" D X 3.9" H • 317mm W X 341mm D X 99mm H • 16.4 lb (7.4 kg) in maximum configuration • Bays 1, 2, 3 flip up (latched and pivoting) • Toolless cover flips up and tilts backward on rear hinges • Toolless disk, optical drive removal • Toolless adapter retention • Toolless systemboard retention • Steel chassis supports 100 lb (45kg) monitor on top • System floor stand for vertical orientation
Implementation	Processor in FC-LGA6 or FC-LGA8 package in LGA775 socket	
Memory	<p>1GB or 2GB std, 8GB max⁸, PC2-5300 667MHz DDR2, non-parity, dual-channel capable, four 240-pin DIMM sockets;</p> <p><i>Italics:</i> standard memory in two sockets; two sockets available</p> <p><i>Non-italics:</i> standard memory in one socket; 3 sockets available</p>	
Graphics	<p><i>Some:</i> Intel Graphics Media Accelerator 3100 (GMA 3100), integrated graphics in Q35, uses main memory (up to 256MB), one analog VGA DB-15 connector</p> <p><i>Some:</i> ADD2 DVI-D Monitor Connection (HDCP), PCI Express[®] adapter in PCIe x16 slot, provides DVI-D connector to support second monitor, HDCP-compliant</p> <p><i>Some:</i> ATI™ Radeon™ HD 2400 XT, PCI Express x16 adapter, 256MB, dual-head support, VGA and DVI-I connectors via dongle, S-Video out for TV-out, HDCP, DirectX[®] 10, ATI Avivo™, dual-link DVI, 35 watts</p>	<p>Security</p> <ul style="list-style-type: none"> • Security chip (see information on left) • Security slot (in rear for attachment of optional Kensington® Microsaver® cable) - optional cable also locks the cover by deactivating the cover release buttons • Power-on password • Administrator password • Hard disk password • Boot sequence control • Boot without keyboard, mouse • Serial port I/O control • Parallel port I/O control • Individual USB port disablement • eSATA port disablement
SATA disk	160GB, 250GB, or 320GB , SATA 3.0Gb/s 7200 rpm, vibration dampening mounts	
SATA controller	Serial ATA, SATA 3.0Gb/s, integrated in ICH9DO, RAID 0/1 support	
SATA DVD	<i>Some:</i> DVD-ROM DL SATA 1.5Gb/s 16-48X Max ⁴ Drive (41N5618)	
SATA DVD±RW	<i>Some:</i> Super Multi-Burner DL DVD±RW SATA 1.5Gb/s Drive (41N5620)	
SATA cables	Two SATA cables (each 1-drop to device), two SATA connectors on planar	
eSATA port	One external SATA (eSATA) port	
EIDE controller	None	
Diskette drive	None	
Media reader	None	
Chipset	Intel Q35 Express Chipset ; I/O Controller Hub 9 Digital Office (ICH9DO) for SATA 3.0Gb/s with RAID 0/1 support, PCI Express x1, ethernet (MAC), PCI 2.3, USB, LPC bus / SMSC [®] SCH5617 Super I/O for serial, parallel, diskette, hardware monitoring (temperature, voltage, fan speed)	<p>Supports ThinkVantage[®] technologies</p> <p>RoHS-compliant</p>
Front ports	Two USB 2.0, microphone (stereo, 3.5mm), headphone (stereo, 3.5mm)	
Rear ports	Six USB 2.0, serial (9-pin), parallel (25-pin), ethernet (RJ-45), eSATA, H7U: monitor (VGA DB-15, DVI-I), S-Video out; Others: monitor (VGA DB-15, DVI-D in some models)	
Internal connector	Two USB 2.0 planar conn (1 used; one open for media reader or 2 rear USB ports)	
Rear audio ports	Line-in (stereo, 3.5mm), line-out (stereo, 3.5mm), microphone-in (stereo, 3.5mm)	
Audio	High Definition (HD) Audio, Analog Devices AD1882 codec	
Speaker	One internal speaker for business audio	
Ethernet	Gigabit ethernet on planar, Intel 82566DM, PCIe x1, Wake on LAN [®] , ASF2.0	
Intel AMT	None	
Modem	None	
Security chip	Winbond [®] WPCT200 SafeKeeper™ Trusted Platform Module, TCG 1.2-compliant	
Keyboard	Preferred Pro USB Keyboard (USB connector), 104-key, black, Lenovo logo	
Mouse	Optical Wheel Mouse (USB connector), black, Lenovo logo	
Power supply	280 watts with variable speed fan, autosensing, two diagnostic LEDs	
Preloaded operating system²⁰	Accessories	
- Microsoft® Windows® XP Professional with Vista® COA	1GB PC2-5300 CL5 NP DDR2 UDIMM	73P4984
◇ Disk-to-Disk Recovery (in hidden protected area)	2GB PC2-5300 CL5 NP DDR2 UDIMM	73P4985
	1GB PC2-6400 NP DDR2 UDIMM	41U2977
	2GB PC2-6400 NP DDR2 UDIMM	41U2978
	USB 2.0 Lenovo Multimedia Headset	40Y8518
Preloaded applications⁵ (only some listed)	ADD2 DVI-D Monitor Connection (HDCP)	43R1985
• Rescue and Recovery™	ATI™ Radeon™ HD 2400 Pro 128MB	43R1961
• Microsoft Office 2007 Trial (60-day)	ATI Radeon HD 2400 XT 256MB	43R1962
• Corel® WinDVD® (DVD, DVD±RW)	Other accessories at lenovo.com/accessories	
• Corel WinDVD Creator (DVD±RW)		

See footnotes for important warranty information
US models announced August 19, 2008

Name	Type-model	Slot x bay	Processor	GHz	L2 cache	Memory ^a	SATA disk	SATA optical	Graphics	eSATA port	Intel vPro	Vista preload	Limited warranty ¹	Global Educ	Avail date
M57	6072-HBU	2x3	Core 2 Duo E7200	2.53	3MB	1GB	160GB ^b	DVD	GMA	eSATA	No	Bus32	3-yr	No	Aug 08
M57	6072-HCU	2x3	Core 2 Duo E7200	2.53	3MB	2GB	160GB	DVD±RW	GMA+ADD2	eSATA	No	Bus32	3-yr	No	Aug 08
M57	6072-HDU	2x3	Core 2 Duo E7200	2.53	3MB	2GB	250GB	DVD	GMA+ADD2	eSATA	No	Bus32	3-yr	No	Aug 08
M57	6072-HFU	2x3	Core 2 Duo E7300	2.66	3MB	1GB	160GB	DVD	GMA+ADD2	eSATA	No	Bus32	3-yr	No	Aug 08
M57	6072-HEU	2x3	Core 2 Duo E7300	2.66	3MB	2GB	250GB	DVD±RW	GMA+ADD2	eSATA	No	Bus32	3-yr	No	Aug 08

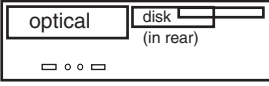
Positioning Processor	<i>Ultimate enterprise stability for large enterprise and mid-market Intel® Core™ 2 Duo Processor E7200 or E7300 with dual-core, Intel 64 Technology, Execute Disable Bit, EIST, and 1066MHz system bus with 3MB shared L2 cache</i> Processor in FC-LGA8 package in LGA775 socket	Small 
Implementation		
Memory	1GB or 2GB std, 8GB max^a, PC2-5300 667MHz DDR2 , non-parity, dual-channel capable, four 240-pin DIMM sockets; <i>Italics:</i> standard memory in two sockets; two sockets available <i>Non-italics:</i> standard memory in one socket; 3 sockets available	Bay ① 5.25", 1.6" high, access, std optical Bay ② 3.5", 1" high, no access, std disk Bay ③ 3.5", .5" high, access, open (reader/diskette) Slot 1: Low Profile, PCI Express x16 (35w max)* Slot 2: Low Profile, 32-bit PCI 2.3 (5v)
Graphics	<i>All:</i> Intel Graphics Media Accelerator 3100 (GMA 3100) , integrated graphics in Q35, uses main memory (up to 256MB), one analog VGA DB-15 connector <i>Some:</i> ADD2 DVI-D Monitor Connection (HDCP) , PCI Express [®] adapter in PCIe x16 slot, provides DVI-D connector to support second monitor, HDCP-compliant	* used in some models • Business black color; metal case • 12.5" W X 13.4" D X 3.9" H • 317mm W X 341mm D X 99mm H • 16.4 lb (7.4 kg) in maximum configuration • Bays 1, 2, 3 flip up (latched and pivoting) • Toolless cover flips up and tilts backward on rear hinges • Toolless disk, optical drive removal • Toolless adapter retention • Toolless systemboard retention • Steel chassis supports 100 lb (45kg) monitor on top • System floor stand for vertical orientation
SATA disk	160GB or 250GB , SATA 3.0Gb/s 7200 rpm, vibration dampening	<p align="center">Security</p> <ul style="list-style-type: none"> • Security chip (see information on left) • Security slot (in rear for attachment of optional Kensington® Microsaver® cable) - optional cable also locks the cover by deactivating the cover release buttons • Power-on password • Administrator password • Hard disk password • Boot sequence control • Boot without keyboard, mouse • Serial port I/O control • Parallel port I/O control • Individual USB port disablement • eSATA port disablement <p>Supports ThinkVantage® technologies</p> <p>RoHS-compliant</p> <p align="center">Limited Warranty¹</p> <ul style="list-style-type: none"> ↪ 3-year parts and labor ↪ International Warranty Service⁹ ↪ Customer Replaceable Unit (CRU) parts only (with limited onsite service for selected parts³, 8 am - 5 pm, Mon - Fri coverage excluding holidays, next business day response time) ↪ Onsite service upgrade options (in eligible locations):⁷ <ul style="list-style-type: none"> • 3-year LOR 9x5, 4 hour response (ThinkPlus™ part number 41C9192) • 3-year LOR 24x7, 4 hour response (ThinkPlus part number 41C9193) • 4-year LOR 9x5, Next Business Day (ThinkPlus part number 41C9194) • 4-year LOR 9x5, 4 hour response (ThinkPlus part number 41C9195) • 4-year LOR 24x7, 4 hour response (ThinkPlus part number 41C9196) ↪ ThinkPlus services at lenovo.com/thinkplus/warranty ↪ Post warranty maintenance services available ↪ 24 hour x 7 day¹⁴ toll-free support during the warranty period¹ via 800-426-7378
SATA controller	Serial ATA, SATA 3.0Gb/s, integrated in ICH9DO, RAID 0/1 support	
SATA DVD	<i>Some:</i> DVD-ROM DL SATA 1.5Gb/s 16-48X Max ⁴ Drive (41N5618)	
SATA DVD±RW	<i>Some:</i> Super Multi-Burner DL DVD±RW SATA Drive (41N5620)	
SATA cables	Two SATA cables (each 1-drop to device), two SATA connectors	
eSATA port	One external SATA (eSATA) port	
EIDE controller	None	
Diskette drive	None	
Media reader	None	
Chipset	Intel Q35 Express Chipset ; I/O Controller Hub 9 Digital Office (ICH9DO) for SATA 3.0Gb/s with RAID 0/1 support, PCI Express x1, ethernet (MAC), PCI 2.3, USB, LPC bus / SMSC® SCH5617 Super I/O for serial, parallel, diskette, hardware monitoring (temperature, voltage, fan speed)	
Front ports	Two USB 2.0, microphone (stereo, 3.5mm), headphone (stereo, 3.5mm)	
Rear ports	Six USB 2.0, serial (9-pin), parallel (25-pin), ethernet (RJ-45), monitor (VGA DB-15, DVI-D in some models), eSATA	
Internal connector	Two USB 2.0 planar conn (1 used; one open for media reader or 2 rear USB ports)	
Rear audio ports	Line-in (stereo, 3.5mm), line-out (stereo, 3.5mm), microphone-in (stereo, 3.5mm)	
Audio	High Definition (HD) Audio, Analog Devices AD1882 codec	
Speaker	One internal speaker for business audio	
Ethernet	Gigabit ethernet on planar, Intel 82566DM, PCIe x1, Wake on LAN®, ASF2.0	
Intel AMT	None	
Modem	None	
Security chip	Winbond® WPCT200 SafeKeeper™ Trusted Platform Module, TCG 1.2-compliant	
Keyboard	Preferred Pro USB Keyboard (USB connector), 104-key, black, Lenovo logo	
Mouse	Optical Wheel Mouse (USB connector), black, Lenovo logo	
Power supply	280 watts with variable speed fan, autosenesing, two diagnostic LEDs	
Preloaded operating system²⁰	Accessories	
- Microsoft® Windows® Vista Business Edition (32-bit)	1GB PC2-5300 CL5 NP DDR2 UDIMM 73P4984	
↕ Vista Premium logo	2GB PC2-5300 CL5 NP DDR2 UDIMM 73P4985	
Preloaded applications⁵	1GB PC2-6400 NP DDR2 UDIMM 41U2977	
• Rescue and Recovery™	2GB PC2-6400 NP DDR2 UDIMM 41U2978	
• Client Security Solution™	250GB SATA 3.0Gb/s Disk (7200 rpm) 41N3015	
• ThinkVantage Productivity Center	500GB SATA 3.0Gb/s Disk (7200 rpm) 43R1990	
• ThinkVantage System Update	USB 2.0 Lenovo Multimedia Headset 40Y8518	
• System Migration Assistant	USB 2.0 Lenovo Webcam 40Y8519	
• Norton Internet Security™	USB 2.0 Essential Memory Key 32GB 45K1258	
(90 days of virus definitions)	USB 2.0 Ultra Secure Memory Key 8GB 45J5918	
• Diskeeper® Home	USB 2.0 Portable 160GB Hard Disk 43R1784	
• PC-Doctor™ (diagnostics)	USB 2.0 Portable Secure 320GB Hard Disk 43R2019	
• Adobe® Reader	USB 2.0 Super Multi-Burner Drive 41N5565	
• Windows Live™ Toolbar	ThinkVision® L1700p 17" Monitor 9417HE2	
• Windows Live Search	ThinkVision L1940p Wide 19" Monitor 4424HB6	
• Picasa from Google	ThinkVision L2240p Wide 22" Monitor 4422HB6	
• Microsoft Office 2007 Trial (60-day)	ThinkVision L2440p Wide 24" Monitor 4420HB2	
• Sonic RecordNow and Drive Letter Access (DVD±RW)	Wireless Kbd & Opt Wheel Mouse (via USB) 73P4067	
• Corel® WinDVD® (DVD, DVD±RW)	Kensington Cable Lock from Lenovo 73P2582	
	ADD2 DVI-D Monitor Connection (HDCP) 43R1985	
	ATI™ Radeon™ HD 2400 Pro 128MB 43R1961	
	ATI Radeon HD 2400 XT 256MB 43R1962	
	Acc Guide in pdf lenovo.com/accessoriesguide	
	Other accessories at lenovo.com/accessories	

See footnotes for important warranty information
US models announced August 19, 2008

ThinkCentre® M57 Small (9181) - ENERGY STAR® 4.0

Personal Systems Reference (PSREF)

Name	Type-model	Slot x bay	Processor	L2 cache	Memory ⁸	SATA disk	SATA optical	Graphics	eSATA port	ENERGY STAR 4.0	Intel vPro	Floor stand	Vista preload	Vista logo	Global Educ	Avail date
M57	9181-A2U	2x3	Pentium E2180	2.00	1MB	2GB	160GB ²	DVD±RW	GMA+ADD2	eSATA	ES40	None	Bus32	Prem	Gbl	Dec 07
M57	9181-A1U	2x3	Core 2 Duo E6550	2.33	4MB	1GB	160GB	Combo	GMA	eSATA	ES40	None	Stand	Bus32	Basic	Nov 07

• **These models have a 3-year limited warranty¹**

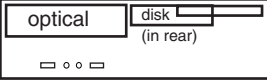
Positioning Processor	<i>Ultimate enterprise stability for large enterprise and mid-market</i> Intel® Pentium® Dual-Core Processor E2180 with dual-core , Intel 64 Technology, Execute Disable Bit, EIST, 800MHz system bus, and 1MB shared L2 cache or Intel Core™ 2 Duo Processor E6550 with dual-core , Intel 64 Technology, Virtualization Technology, Execute Disable Bit, EIST, TXT, and 1333MHz system bus with 4MB shared L2 cache Processor in FC-LGA6 package in LGA775 socket		Small	
Implementation	Processor in FC-LGA6 package in LGA775 socket		Bay ① 5.25", 1.6" high, access, std optical Bay ② 3.5", 1" high, no access, std disk Bay ③ 3.5", .5" high, access, open (reader/diskette)	
Memory	1GB or 2GB std, 8GB max ⁸ , PC2-5300 667MHz DDR2 , non-parity, dual-channel capable, four 240-pin DIMM sockets; <i>Italics:</i> dual memory in two sockets; two sockets available <i>Non-italics:</i> standard memory in one socket; 3 sockets available		Slot 1: Low Profile, PCI Express x16 (35w max)* Slot 2: Low Profile, 32-bit PCI 2.3 (5v) * used in some models	
Graphics	<i>All:</i> Intel Graphics Media Accelerator 3100 (GMA 3100) , integrated graphics in Q35, uses main memory (up to 256MB), one analog VGA DB-15 connector <i>Some:</i> ADD2 DVI-D Monitor Connection (HDCP) , PCI Express® adapter in PCIe x16 slot, provides DVI-D connector to support second monitor, HDCP-compliant		<ul style="list-style-type: none"> • Business black color; metal case • 12.5" W X 13.4" D X 3.9" H • 317mm W X 341mm D X 99mm H • 16.4 lb (7.4 kg) in maximum configuration • Bays 1, 2, 3 flip up (latched and pivoting) • Toolless cover flips up and tilts backward on rear hinges • Toolless disk, optical drive removal • Toolless adapter retention • Toolless systemboard retention • Steel chassis supports 100 lb (45kg) monitor on top • <i>Some:</i> system floor stand for vertical orientation 	
SATA disk	160GB , SATA 3.0Gb/s 7200 rpm, vibration dampening mounts			<p>Security</p> <ul style="list-style-type: none"> • Security chip (see information on left) • Security slot (in rear for attachment of optional Kensington® Microsaver® cable) - optional cable also locks the cover by deactivating the cover release buttons • Power-on password • Administrator password • Hard disk password • Boot sequence control • Boot without keyboard, mouse • Serial port I/O control • Parallel port I/O control • Individual USB port disablement • eSATA port disablement <p>Supports ThinkVantage® technologies</p> <p>EPEAT™ Gold rating ENERGY STAR 4.0-compliant RoHS-compliant</p> <p>Limited Warranty¹</p> <ul style="list-style-type: none"> ↪ 3-year parts and labor ↪ International Warranty Service⁹ ↪ Customer Replaceable Unit (CRU) parts only (with limited onsite service for selected parts³, 8 am - 5 pm, Mon - Fri coverage excluding holidays, next business day response time) ↪ Onsite service upgrade options (in eligible locations):⁷ <ul style="list-style-type: none"> • 3-year LOR 9x5, 4 hour response (ThinkPlus™ part number 41C9192) • 3-year LOR 24x7, 4 hour response (ThinkPlus part number 41C9193) • 4-year LOR 9x5, Next Business Day (ThinkPlus part number 41C9194) • 4-year LOR 9x5, 4 hour response (ThinkPlus part number 41C9195) • 4-year LOR 24x7, 4 hour response (ThinkPlus part number 41C9196) ↪ ThinkPlus services at lenovo.com/thinkplus/warranty ↪ Post warranty maintenance services available ↪ 24 hour x 7 day¹⁴ toll-free support during the warranty period¹ via 800-426-7378
SATA controller	Serial ATA, SATA 3.0Gb/s, integrated in ICH9DO, RAID 0/1 support			
SATA Combo	<i>Some:</i> CD-RW/DVD-ROM Combo SATA 1.5Gb/s Drive			
SATA DVD±RW	<i>Some:</i> Super Multi-Burner DL DVD±RW SATA Drive (41N5620)			
SATA cables	Two SATA cables (each 1-drop to device), two SATA connectors on planar			
eSATA port	One external SATA (eSATA) port			
EIDE controller	None			
Diskette drive	None			
Media reader	None			
Chipset	Intel Q35 Express Chipset ; I/O Controller Hub 9 Digital Office (ICH9DO) for SATA 3.0Gb/s with RAID 0/1 support, PCI Express x1, ethernet (MAC), PCI 2.3, USB, LPC bus / SMSC® SCH5617 Super I/O for serial, parallel, diskette, hardware monitoring (temperature, voltage, fan speed)			
Front ports	Two USB 2.0, microphone (stereo, 3.5mm), headphone (stereo, 3.5mm)			
Rear ports	Six USB 2.0, serial (9-pin), parallel (25-pin), ethernet (RJ-45), monitor (VGA DB-15, DVI-D in some models), eSATA			
Internal connector	Two USB 2.0 planar conn (1 used; one open for media reader or 2 rear USB ports)			
Rear audio ports	Line-in (stereo, 3.5mm), line-out (stereo, 3.5mm), microphone-in (stereo, 3.5mm)			
Audio	High Definition (HD) Audio, Analog Devices AD1882 codec			
Speaker	One internal speaker for business audio			
Ethernet	Gigabit ethernet on planar, Intel 82566DM, PCIe x1, Wake on LAN®, ASF2.0			
Intel AMT	None			
Modem	None			
Security chip	Winbond® WPCT200 SafeKeeper™ Trusted Platform Module, TCG 1.2-compliant			
Keyboard	Preferred Pro USB Keyboard (USB connector), 104-key, black, Lenovo logo			
Mouse	Optical Wheel Mouse (USB connector), black, Lenovo logo			
Power supply	280 watts with variable speed fan, autosensing, two diagnostic LEDs, 80% PSU			
Preloaded operating system²⁰	Accessories			
- Microsoft® Vista® Business Edition (32-bit)	1GB PC2-5300 CL5 NP DDR2 UDIMM	73P4984		
	2GB PC2-5300 CL5 NP DDR2 UDIMM	73P4985		
	1GB PC2-6400 NP DDR2 UDIMM	41U2977		
	2GB PC2-6400 NP DDR2 UDIMM	41U2978		
	250GB SATA 3.0Gb/s Disk (7200 rpm)	41N3015		
	500GB SATA 3.0Gb/s Disk (7200 rpm)	43R1990		
	USB 2.0 Lenovo Multimedia Headset	40Y8518		
	USB 2.0 Lenovo Webcam	40Y8519		
	USB 2.0 Essential Memory Key 32GB	45K1258		
	USB 2.0 Ultra Secure Memory Key 2GB	45J5916		
	USB 2.0 Ultra Secure Memory Key 4GB	45J5917		
	USB 2.0 Ultra Secure Memory Key 8GB	45J5918		
	USB 2.0 Portable 160GB Hard Disk	43R1784		
	USB 2.0 Portable Secure 320GB Hard Disk	43R2019		
	USB 2.0 Super Multi-Burner Drive	41N5565		
	ThinkVision® L1940p Wide 19" Monitor	4424HB6		
	ThinkVision L2240p Wide 22" Monitor	4422HB6		
	ThinkVision L2440p Wide 24" Monitor	4420HB2		
	Wireless Kbd & Opt Wheel Mouse (via USB)	73P4067		
	Kensington Cable Lock from Lenovo	73P2582		
	ADD2 DVI-D Monitor Connection (HDCP)	43R1985		
	ATI™ Radeon™ HD 2400 Pro 128MB	43R1961		
	ATI Radeon HD 2400 XT 256MB	43R1962		
	Acc Guide in pdf lenovo.com/accessoriesguide			
	Other accessories at lenovo.com/accessories			

See footnotes for important warranty information

US model announced December 4, 2007; previous model on September 18, 2007

© Lenovo

(APOL1-3) December 2007

Name	Type-model	Slot x bay	Processor	GHz	L2 cache	Memory ⁸	SATA disk	SATA optical	Graphics	eSATA port	Intel vPro	Preload	Limited warranty ¹	Global Educ	Avail date
M57	9978-A1U	4x5	Core 2 Duo E7200	2.53	3MB	1GB	160GB ²	DVD±RW	GMA	None	None	XP Pro	3-yr	None	Jun 08
M57	9978-A2U	4x5	Core 2 Duo E8400	3.00	6MB	1GB	160GB	DVD±RW	GMA	None	None	XP Pro	3-yr	None	Jun 08

- These small and medium business (SMB) models are part of the US TopSeller™ Program

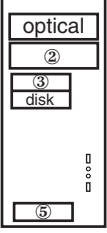
Positioning Processor	<p><i>Ultimate stability for small and medium businesses</i></p> <p>Intel® Core™ 2 Duo Processor E7200 with dual-core, Intel 64 Technology, Execute Disable Bit, EIST, 1066MHz system bus, and 3MB shared L2 cache or Intel Core 2 Duo Processor E8400 with dual-core, Intel 64 Technology, Virtualization Technology, Execute Disable Bit, EIST, TXT, and 1333MHz system bus with 6MB shared L2 cache Processor in FC-LGA8 package in LGA775 socket</p>		<p>Tower</p> <ul style="list-style-type: none"> • Business black color; metal case • 6.9" W X 17.0" D X 15.7" H • 175mm W X 432mm D X 400mm H • 22.5 lb (10.2 kg) in max configuration • Handle on top front • Toolless cover removal • Toolless disk, diskette drive, optical drive removal • Toolless adapter retention 
Implementation	<p>1GB std, 8GB max⁸, PC2-5300 667MHz DDR2, non-parity, dual-channel capable, four 240-pin DIMM sockets; <i>Non-italics</i>: standard memory in one socket; 3 sockets available</p>		
Memory	<p>Intel Graphics Media Accelerator 3100 (GMA 3100), integrated graphics in Q35, uses main memory (up to 256MB), one analog VGA DB-15 connector, supports dual independent display with optional ADD2 adapter</p>		<p>Bay ① 5.25", 1.6" high, access, std optical</p> <p>Bay ② 5.25", 1.6" high, access, open</p> <p>Bay ③ 3.5", 1" high, access, open (reader/diskette)</p> <p>Bay ④ 3.5", 1" high, no access, std disk</p> <p>Bay ⑤ 3.5", 1" high, no access, opt disk</p>
Graphics	<p>160GB, SATA 3.0Gb/s 7200 rpm, vibration dampening mounts Serial ATA, SATA 3.0Gb/s, integrated in ICH9DO, RAID 0/1 support Super Multi-Burner DL DVD±RW SATA 1.5Gb/s Drive (41N5620) Two SATA cables (each 1-drop to device), three SATA connectors and one eSATA/SATA connector on planar</p>		<p>Slot 1: half-length, full-height, PCI Express x16 (75w max)</p> <p>Slot 2: half-length, full-height, PCI Express x1</p> <p>Slot 3: half-length, full-height, 32-bit PCI 2.3 (5v)</p> <p>Slot 4: half-length, full-height, 32-bit PCI 2.3 (5v)</p>
SATA disk	<p>None</p>		<p>Security</p> <ul style="list-style-type: none"> • Security chip (see information on left) • One lock to secure both cover and entire system to fixed object: <ul style="list-style-type: none"> - Padlock loop (in rear for opt padlock) - Security slot (in rear for optional Kensington® Microsaver® cable) • Power-on password • Administrator password • Hard disk password • Boot sequence control • Boot without keyboard, mouse, diskette • Serial port I/O control • Parallel port I/O control • Individual USB port disablement
SATA controller	<p>None</p>		
SATA DVD±RW	<p>None</p>		
SATA cables	<p>None</p>		
eSATA port	<p>None</p>		<p>Supports ThinkVantage® technologies</p>
EIDE controller	<p>None</p>		
Diskette drive	<p>None</p>		<p>RoHS-compliant</p>
Media reader	<p>None</p>		
Chipset	<p>Intel Q35 Express Chipset; I/O Controller Hub 9 Digital Office (ICH9DO) for SATA 3.0Gb/s with RAID 0/1 support, PCI Express® x1, ethernet (MAC), PCI 2.3, USB, LPC bus / SMSC® SCH5617 Super I/O for serial, parallel, diskette, hardware monitoring (temperature, voltage, fan speed)</p>		<p>Limited Warranty¹</p> <ul style="list-style-type: none"> ↔ 3-year parts and labor ↔ International Warranty Service⁹ ↔ Customer Replaceable Unit (CRU) parts only (with limited onsite service for selected parts³, 8 am - 5 pm, Mon - Fri coverage excluding holidays, next business day response time) ↔ Onsite service upgrade options (in eligible locations)⁷ <ul style="list-style-type: none"> • 3-year LOR 9x5, 4 hour response (ThinkPlus™ part number 41C9192) • 3-year LOR 24x7, 4 hour response (ThinkPlus part number 41C9193) • 4-year LOR 9x5, Next Business Day (ThinkPlus part number 41C9194) • 4-year LOR 9x5, 4 hour response (ThinkPlus part number 41C9195) • 4-year LOR 24x7, 4 hour response (ThinkPlus part number 41C9196) ↔ ThinkPlus services at lenovo.com/thinkplus/warranty ↔ Post warranty maintenance services available ↔ 24 hour x 7 day¹⁴ toll-free support during the warranty period¹ via 800-426-7378
Front ports	<p>Two USB 2.0, microphone (stereo, 3.5mm), headphone (stereo, 3.5mm)</p>		
Rear ports	<p>Six USB 2.0, serial (9-pin), parallel (25-pin), keyboard (PS/2), mouse (PS/2), ethernet (RJ-45), monitor (VGA DB-15)</p>		
Internal connector	<p>Two USB 2.0 planar conn (1 used; one open for media reader or 2 rear USB ports)</p>		
Rear audio ports	<p>Line-in (stereo, 3.5mm), line-out (stereo, 3.5mm), microphone-in (stereo, 3.5mm)</p>		
Audio	<p>High Definition (HD) Audio, Analog Devices AD1882 codec</p>		
Speaker	<p>One internal speaker for business audio</p>		
Ethernet	<p>Gigabit ethernet on planar, Intel 82566DM, PCIe x1, Wake on LAN®, ASF2.0</p>		
Intel AMT	<p>None</p>		
Modem	<p>None</p>		
Security chip	<p>Winbond® WPCT200 SafeKeeper™ Trusted Platform Module, TCG 1.2-compliant</p>		
Keyboard	<p>Preferred Pro USB Keyboard (USB connector), 104-key, black, Lenovo logo</p>		
Mouse	<p>Optical Wheel Mouse (USB connector), black, Lenovo logo</p>		
Power supply	<p>280 watts with variable speed fan, manual switch, two diagnostic LEDs</p>		
Preloaded operating system²⁰	<p>Accessories</p>		
- Microsoft® Windows® XP Professional with Vista® COA	1GB PC2-5300 CL5 NP DDR2 UDIMM	73P4984	
↔ Disk-to-Disk Recovery (in hidden protected area)	2GB PC2-5300 CL5 NP DDR2 UDIMM	73P4985	
Preloaded applications⁵	1GB PC2-6400 NP DDR2 UDIMM	41U2977	
• Rescue and Recovery™	2GB PC2-6400 NP DDR2 UDIMM	41U2978	
• Client Security Solution™	250GB SATA 3.0Gb/s Disk (7200 rpm)	41N3015	
• ThinkVantage Productivity Center	500GB SATA 3.0Gb/s Disk (7200 rpm)	43R1990	
• ThinkVantage System Update	USB Portable Diskette Drive	05K9276	
• System Migration Assistant	USB 2.0 Lenovo Multimedia Headset	40Y8518	
• Norton Internet Security™	USB 2.0 Lenovo Webcam	40Y8519	
• Diskeeper® Home	USB 2.0 Essential Memory Key 32GB	45K1258	
• PC-Doctor™ (diagnostics)	USB 2.0 Ultra Secure Memory Key 8GB	45J5918	
• Adobe® Reader	USB 2.0 Portable Secure 320GB Hard Disk	43R2019	
• Windows Live™ Toolbar	ThinkVision® L2240p Wide 22" Monitor	4422HB6	
• Windows Live Search	ThinkVision L2440p Wide 24" Monitor	4420HB2	
• Picasa from Google	Wireless Kbd & Opt Wheel Mouse (via USB)	73P4067	
• Microsoft Office 2007 Trial (60-day)	Kensington Cable Lock from Lenovo	73P2582	
• Multimedia Center for Think Offerings (DVD±RW)	ADD2 DVI-D Monitor Connection (HDCP)	43R1985	
• Sonic RecordNow and Drive Letter Access (DVD±RW)	ATI™ Radeon™ HD 2400 Pro 128MB	43R1961	
• Corel® WinDVD® (DVD±RW)	ATI Radeon HD 2400 XT 256MB	43R1962	
• Corel WinDVD Creator (DVD±RW)	ATI Radeon HD 2600 XT 512MB	43R1963	
	NVIDIA® Quadro® 256MB NVS 290	43R1765	
	NVIDIA Quadro 256MB FX 370	43R1766	
	NVIDIA Quadro 512MB FX 1700	43R1767	
	Acc Guide in pdf lenovo.com/accessoriesguide		
	Other accessories at lenovo.com/accessories		

See footnotes for important warranty information
US models announced June 24, 2008

ThinkCentre® M57 Tower (6075)

Personal Systems Reference (PSREF)

Name	Type-model	Slot x bay	Processor	GHz	L2 cache	Memory ⁸	SATA disk	SATA optical	Graphics	eSATA port	Intel vPro	Preload	Limited warranty ¹	Global Educ	Avail date
M57	6075-BSU	4x5	Pentium E2140	1.60	1MB	1GB	80GB ²	DVD	GMA	None	None	XP Pro	3-yr		Oct 07
M57	6075-BTU	4x5	Pentium E2140	1.60	1MB	1GB	80GB	Combo	GMA	None	None	XP Pro	3-yr		Oct 07
M57	6075-BRU	4x5	Core 2 Duo E4400	2.00	2MB	1GB	80GB	DVD	GMA	None	None	XP Pro	3-yr		Oct 07
M57	6075-BGU	4x5	Pentium E2160	1.80	1MB	1GB	80GB	DVD	GMA	None	None	Business32	3-yr	Gbl	Nov 07
M57	6075-BHU	4x5	Pentium E2160	1.80	1MB	1GB	80GB	Combo	GMA	None	None	Business32	3-yr		Oct 07
M57	6075-BJU	4x5	Pentium E2160	1.80	1MB	1GB	320GB	DVD±RW	GMA	None	None	Business32	3-yr		Oct 07
M57	6075-A4U	4x5	Core 2 Duo E4400	2.00	2MB	1GB	80GB	DVD	GMA	None	None	Business32	3-yr		Oct 07
M57	6075-AEU	4x5	Core 2 Duo E4400	2.00	2MB	1GB	160GB	DVD±RW	GMA	None	None	Business32	3-yr		Oct 07
M57	6075-AHU	4x5	Core 2 Duo E6550	2.33	4MB	1GB	80GB	DVD	GMA	None	None	Business32	3-yr		Oct 07
M57	6075-BQU	4x5	Core 2 Duo E6550	2.33	4MB	1GB	80GB	DVD	GMA	None	None	Business32	3-yr	Gbl	Oct 07
M57	6075-AGU	4x5	Core 2 Duo E6550	2.33	4MB	1GB	80GB	Combo	GMA	None	None	Business32	3-yr		Oct 07
M57	6075-A5U	4x5	Core 2 Duo E6550	2.33	4MB	1GB	80GB	Combo	GMA	None	None	Business32	3-yr	Gbl	Oct 07
M57	6075-AFU	4x5	Core 2 Duo E6550	2.33	4MB	1GB	160GB	DVD±RW	GMA	None	None	Business32	3-yr		Oct 07

Positioning Processor	<p><i>Ultimate enterprise stability for large enterprise and mid-market</i></p> <p>Intel® Pentium® Dual-Core Processor E2140 or E2160 with dual-core, Intel 64 Technology, Execute Disable Bit, EIST, 800MHz system bus, and 1MB shared L2 cache or Intel Core™ 2 Duo Processor E4400 with dual-core, Intel 64 Technology, Execute Disable Bit, EIST, 800MHz system bus, and 2MB shared L2 cache or Intel Core 2 Duo Processor E6550 with dual-core, Intel 64 Technology, Virtualization Technology, Execute Disable Bit, EIST, TXT, and 1333MHz system bus with 4MB shared L2 cache Processor in FC-LGA6 package in LGA775 socket</p>		<p>Tower</p> <ul style="list-style-type: none"> • Business black color; metal case • 6.9" W X 17.0" D X 15.7" H • 175mm W X 432mm D X 400mm H • 22.5 lb (10.2 kg) in max configuration • Handle on top front • Toolless cover removal • Toolless disk, diskette drive, optical drive removal • Toolless adapter retention 	
Implementation	<p>1GB std, 8GB max⁸, PC2-5300 667MHz DDR2, non-parity, dual-channel capable, four 240-pin DIMM sockets; <i>Non-italics</i>: standard memory in one socket; 3 sockets available</p>		<p>Bay ① 5.25", 1.6" high, access, std optical</p> <p>Bay ② 5.25", 1.6" high, access, open</p> <p>Bay ③ 3.5", 1" high, access, open (reader/diskette)</p> <p>Bay ④ 3.5", 1" high, no access, std disk</p> <p>Bay ⑤ 3.5", 1" high, no access, opt disk</p> <p>Slot 1: half-length, full-height, PCI Express x16 (75w max)</p> <p>Slot 2: half-length, full-height, PCI Express x1</p> <p>Slot 3: half-length, full-height, 32-bit PCI 2.3 (5v)</p> <p>Slot 4: half-length, full-height, 32-bit PCI 2.3 (5v)</p>	
Memory	<p>Intel Graphics Media Accelerator 3100 (GMA 3100), integrated graphics in Q35, uses main memory (up to 256MB), one analog VGA DB-15 connector, supports dual independent display with optional ADD2 adapter</p>			
Graphics	<p>80, 160, or 320GB, SATA 3.0Gb/s 7200 rpm, vibration dampening Serial ATA, SATA 3.0Gb/s, integrated in ICH9DO, RAID 0/1 support <i>Some</i>: DVD-ROM DL SATA 1.5Gb/s 16-48X Max⁴ Drive (41N5618) <i>Some</i>: CD-RW/DVD-ROM Combo SATA 1.5Gb/s Drive <i>Some</i>: Super Multi-Burner DL DVD±RW SATA 1.5Gb/s Drive (41N5620) Two SATA cables (each 1-drop to device), three SATA connectors and one eSATA/SATA connector on planar</p>			
SATA disk	<p>None</p>			
SATA controller	<p>None</p>			
SATA DVD	<p>None</p>			
SATA Combo	<p>None</p>			
SATA DVD±RW	<p>None</p>			
SATA cables	<p>None</p>			
eSATA port	<p>None</p>			
EIDE controller	<p>None</p>			
Diskette drive	<p>None</p>			
Media reader	<p>None</p>			
Chipset	<p>Intel Q35 Express Chipset; I/O Controller Hub 9 Digital Office (ICH9DO) for SATA 3.0Gb/s with RAID 0/1 support, PCI Express[®] x1, ethernet (MAC), PCI 2.3, USB, LPC bus / SMSC[®] SCH5617 Super I/O for serial, parallel, diskette, hardware monitoring (temperature, voltage, fan speed)</p>			
Front ports	<p>Two USB 2.0, microphone (stereo, 3.5mm), headphone (stereo, 3.5mm)</p>			
Rear ports	<p>Six USB 2.0, serial (9-pin), parallel (25-pin), keyboard (PS/2), mouse (PS/2), ethernet (RJ-45), monitor (VGA DB-15)</p>			
Internal connector	<p>Two USB 2.0 planar conn (1 used; one open for media reader or 2 rear USB ports)</p>			
Rear audio ports	<p>Line-in (stereo, 3.5mm), line-out (stereo, 3.5mm), microphone-in (stereo, 3.5mm)</p>			
Audio	<p>High Definition (HD) Audio, Analog Devices AD1882 codec</p>			
Speaker	<p>One internal speaker for business audio</p>			
Ethernet	<p>Gigabit ethernet on planar, Intel 82566DM, PCIe x1, Wake on LAN[®], ASF2.0</p>			
Intel AMT	<p>None</p>			
Modem	<p>None</p>			
Security chip	<p>Winbond[®] WPCT200 SafeKeeper™ Trusted Platform Module, TCG 1.2-compliant</p>			
Keyboard	<p>Preferred Pro USB Keyboard (USB connector), 104-key, black, Lenovo logo</p>			
Mouse	<p>Optical Wheel Mouse (USB connector), black, Lenovo logo</p>			
Power supply	<p>280 watts with variable speed fan, manual switch, two diagnostic LEDs</p>			
Preloaded operating system ²⁰	<p>Accessories</p> <ul style="list-style-type: none"> - <i>Some</i>: Microsoft® Windows® XP Professional - <i>Some</i>: Microsoft Windows Vista® Business Edition (32-bit) ◇ <i>Vista models</i>: Vista Basic logo 		<ul style="list-style-type: none"> 1GB PC2-5300 CL5 NP DDR2 UDIMM 73P4984 2GB PC2-5300 CL5 NP DDR2 UDIMM 73P4985 1GB PC2-6400 NP DDR2 UDIMM 41U2977 2GB PC2-6400 NP DDR2 UDIMM 41U2978 USB 2.0 Ultra Secure Memory Key 8GB 45J5918 ThinkVision® L2440p Wide 24" Monitor 4420HB2 Kensington Cable Lock from Lenovo 73P2582 ADD2 DVI-D Monitor Connection (HDCP) 43R1985 ATI™ Radeon™ HD 2400 Pro 128MB 43R1961 ATI Radeon HD 2400 XT 256MB 43R1962 ATI Radeon HD 2600 XT 512MB 43R1963 NVIDIA® Quadro® 256MB NVS 290 43R1765 NVIDIA Quadro 256MB FX 370 43R1766 NVIDIA Quadro 512MB FX 1700 43R1767 	
Preloaded applications ⁵ (all OSes; only some listed)	<ul style="list-style-type: none"> • Rescue and Recovery™ • Client Security Solution™ • ThinkVantage Productivity Center • Diskeeper® Home • Microsoft Office 2007 Trial (60-day) • Sonic RecordNow and Drive Letter Access (combo, DVD±RW) • Corel® WinDVD® (combo, DVD, DVD±RW) 			
	<p>Other accessories at lenovo.com/accessories</p>			
	<p>Security</p> <ul style="list-style-type: none"> • Security chip (see information on left) • One lock to secure both cover and entire system to fixed object: <ul style="list-style-type: none"> - Padlock loop (in rear for opt padlock) - Security slot (in rear for optional Kensington® Microsaver® cable) • Power-on password • Administrator password • Hard disk password • Boot sequence control • Boot without keyboard, mouse, diskette • Serial port I/O control • Parallel port I/O control • Individual USB port disablement 			
	<p>Supports ThinkVantage® technologies</p>			
	<p>RoHS-compliant</p>			
	<p>Limited Warranty¹</p> <ul style="list-style-type: none"> ⇨ 3-year parts and labor ⇨ International Warranty Service⁹ ⇨ Customer Replaceable Unit (CRU) parts only (with limited onsite service for selected parts³, 8 am - 5 pm, Mon - Fri coverage excluding holidays, next business day response time) ⇨ Onsite service upgrade options (in eligible locations):⁷ <ul style="list-style-type: none"> • 3-year LOR 9x5, 4 hour response (ThinkPlus™ part number 41C9192) • 3-year LOR 24x7, 4 hour response (ThinkPlus part number 41C9193) • 4-year LOR 9x5, Next Business Day (ThinkPlus part number 41C9194) • 4-year LOR 9x5, 4 hour response (ThinkPlus part number 41C9195) • 4-year LOR 24x7, 4 hour response (ThinkPlus part number 41C9196) ⇨ ThinkPlus services at lenovo.com/thinkplus/warranty ⇨ 24 hour x 7 day¹⁴ toll-free support during the warranty period¹ via 800-426-7378 			

See footnotes for important warranty information

¹⁸ US model announced October 16, 2007; previous models on September 18, 2007

¹⁹ US models withdrawn effective June or September 2008

© Lenovo (APOL1-4) October 2007

Name	Type-model	Slot x bay	Processor	GHz	L2 cache	Memory ⁶	SATA disk	SATA optical	Graphics	eSATA port	Intel vPro	Preload	Vista logo	Global Educ	Avail date
M57	6075-E7U	4x5	Pentium E2160	1.80	1MB	1GB	160GB ²	DVD	GMA	None	None	XP Pro		Gbl	Dec 07
M57	6075-E8U	4x5	Core 2 Duo E4500	2.20	2MB	1GB	160GB	DVD	GMA	None	None	XP Pro		Gbl	Dec 07
M57	6075-DNU	4x5	Core 2 Quad Q6600	2.40	8MB	2GB	160GB	DVD±RW	GMA	None	None	XP Pro			Dec 07
M57	6075-EAU	4x5	Pentium E2160	1.80	1MB	1GB	160GB	DVD±RW	GMA	None	None	Business32	Basic	Gbl	Dec 07
M57	6075-E9U	4x5	Core 2 Duo E6550	2.33	4MB	1GB	160GB	DVD±RW	GMA	None	None	Business32	Basic	Gbl	Dec 07
M57	6075-DPU	4x5	Core 2 Quad Q6600	2.40	8MB	2GB	160GB	DVD±RW	GMA	None	None	Business32	Prem		Dec 07

• These models have a 3-year limited warranty¹

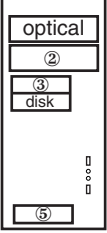
Positioning Processor	<p><i>Ultimate enterprise stability for large enterprise and mid-market</i></p> <p>Intel® Pentium® Dual-Core Processor E2160 with dual-core, Intel 64 Technology, Execute Disable Bit, EIST, 800MHz system bus, and 1MB shared L2 cache or Intel Core™ 2 Duo Processor E4500 with dual-core, Intel 64 Technology, Execute Disable Bit, EIST, 800MHz system bus, and 2MB shared L2 cache or Intel Core 2 Duo Processor E6550 with dual-core, Intel 64 Technology, Virtualization Technology, Execute Disable Bit, EIST, TXT, and 1333MHz system bus with 4MB shared L2 cache or Intel Core 2 Quad Processor Q6600 with quad-core (dual-core on dual-die), Intel 64 Technology, Virtualization Technology, Execute Disable Bit, EIST, and 1066MHz system bus with 8MB shared L2 cache Processor in FC-LGA6 package in LGA775 socket</p>	<p>Tower</p> <ul style="list-style-type: none"> • Business black color; metal case • 6.9" W X 17.0" D X 15.7" H • 175mm W X 432mm D X 400mm H • 22.5 lb (10.2 kg) in max configuration • Handle on top front • Toolless cover removal • Toolless disk, diskette drive, optical drive removal • Toolless adapter retention 																																	
Implementation	Processor in FC-LGA6 package in LGA775 socket	<p>Bay ① 5.25", 1.6" high, access, std optical</p> <p>Bay ② 5.25", 1.6" high, access, open</p> <p>Bay ③ 3.5", 1" high, access, open (reader/diskette)</p> <p>Bay ④ 3.5", 1" high, no access, std disk</p> <p>Bay ⑤ 3.5", 1" high, no access, opt disk</p> <p>Slot 1: half-length, full-height, PCI Express x16 (75w max)</p> <p>Slot 2: half-length, full-height, PCI Express x1</p> <p>Slot 3: half-length, full-height, 32-bit PCI 2.3 (5v)</p> <p>Slot 4: half-length, full-height, 32-bit PCI 2.3 (5v)</p>																																	
Memory	<p>1GB or 2GB std, 8GB max⁸, PC2-5300 667MHz DDR2, non-parity, dual-channel capable, four 240-pin DIMM sockets; <i>Non-italics</i>: standard memory in one socket; 3 sockets available</p>	<p>Security</p> <ul style="list-style-type: none"> • Security chip (see information on left) • One lock to secure both cover and entire system to fixed object: <ul style="list-style-type: none"> - Padlock loop (in rear for opt padlock) - Security slot (in rear for optional Kensington® Microsaver® cable) • Power-on password • Administrator password • Hard disk password • Boot sequence control • Boot without keyboard, mouse, diskette • Serial port I/O control • Parallel port I/O control • Individual USB port disablement <p>Supports ThinkVantage® technologies</p> <p>RoHS-compliant</p> <p>Limited Warranty¹</p> <ul style="list-style-type: none"> ↪ 3-year parts and labor ↪ International Warranty Service⁹ ↪ Customer Replaceable Unit (CRU) parts only (with limited onsite service for selected parts³, 8 am - 5 pm, Mon - Fri coverage excluding holidays, next business day response time) ↪ Onsite service upgrade options (in eligible locations):⁷ <ul style="list-style-type: none"> • 3-year LOR 9x5, 4 hour response (ThinkPlus™ part number 41C9192) • 3-year LOR 24x7, 4 hour response (ThinkPlus part number 41C9193) • 4-year LOR 9x5, Next Business Day (ThinkPlus part number 41C9194) • 4-year LOR 9x5, 4 hour response (ThinkPlus part number 41C9195) • 4-year LOR 24x7, 4 hour response (ThinkPlus part number 41C9196) ↪ ThinkPlus services at lenovo.com/thinkplus/warranty ↪ Post warranty maintenance services available ↪ 24 hour x 7 day¹⁴ toll-free support during the warranty period¹ via 800-426-7378 																																	
Graphics	<p>Intel Graphics Media Accelerator 3100 (GMA 3100), integrated graphics in Q35, uses main memory (up to 256MB), one analog VGA DB-15 connector, supports dual independent display with optional ADD2 adapter</p>																																		
SATA disk	<p>160GB, SATA 3.0Gb/s 7200 rpm, vibration dampening mounts</p>																																		
SATA controller	<p>Serial ATA, SATA 3.0Gb/s, integrated in ICH9DO, RAID 0/1 support</p>																																		
SATA DVD	<p><i>Some</i>: DVD-ROM DL SATA 1.5Gb/s 16-48X Max⁴ Drive (41N5618)</p>																																		
SATA DVD±RW	<p><i>Some</i>: Super Multi-Burner DL DVD±RW SATA 1.5Gb/s Drive (41N5620)</p>																																		
SATA cables	<p>Two SATA cables (each 1-drop to device), three SATA connectors and one eSATA/SATA connector on planar</p>																																		
eSATA port	None																																		
EIDE controller	None																																		
Diskette drive	None																																		
Media reader	None																																		
Chipset	<p>Intel Q35 Express Chipset; I/O Controller Hub 9 Digital Office (ICH9DO) for SATA 3.0Gb/s with RAID 0/1 support, PCI Express® x1, ethernet (MAC), PCI 2.3, USB, LPC bus / SMSC® SCH5617 Super I/O for serial, parallel, diskette, hardware monitoring (temperature, voltage, fan speed)</p>																																		
Front ports	Two USB 2.0, microphone (stereo, 3.5mm), headphone (stereo, 3.5mm)																																		
Rear ports	Six USB 2.0, serial (9-pin), parallel (25-pin), keyboard (PS/2), mouse (PS/2), ethernet (RJ-45), monitor (VGA DB-15)																																		
Internal connector	Two USB 2.0 planar conn (1 used; one open for media reader or 2 rear USB ports)																																		
Rear audio ports	Line-in (stereo, 3.5mm), line-out (stereo, 3.5mm), microphone-in (stereo, 3.5mm)																																		
Audio	High Definition (HD) Audio, Analog Devices AD1882 codec																																		
Speaker	One internal speaker for business audio																																		
Ethernet	Gigabit ethernet on planar, Intel 82566DM, PCIe x1, Wake on LAN®, ASF2.0																																		
Intel AMT	None																																		
Modem	None																																		
Security chip	Winbond® WPCT200 SafeKeeper™ Trusted Platform Module, TCG 1.2-compliant																																		
Keyboard	Preferred Pro USB Keyboard (USB connector), 104-key, black, Lenovo logo																																		
Mouse	Optical Wheel Mouse (USB connector), black, Lenovo logo																																		
Power supply	280 watts with variable speed fan, manual switch, two diagnostic LEDs																																		
Preloaded operating system²⁰	<p>- <i>Some</i>: Microsoft® Windows® XP Professional with Vista® COA</p> <p>- <i>Some</i>: Microsoft Windows Vista Business Edition (32-bit)</p>																																		
Preloaded applications⁵ (all OSes; only some listed)	<ul style="list-style-type: none"> • Rescue and Recovery™ • Client Security Solution™ • ThinkVantage Productivity Center • ThinkVantage System Update • System Migration Assistant • Norton Internet Security™ • Diskeeper® Home • Microsoft Office 2007 Trial (60-day) • Sonic RecordNow and Drive Letter Access (DVD±RW) • Corel® WinDVD® (DVD, DVD±RW) 																																		
Accessories	<table border="0"> <tr><td>1GB PC2-5300 CL5 NP DDR2 UDIMM</td><td>73P4984</td></tr> <tr><td>2GB PC2-5300 CL5 NP DDR2 UDIMM</td><td>73P4985</td></tr> <tr><td>1GB PC2-6400 NP DDR2 UDIMM</td><td>41U2977</td></tr> <tr><td>2GB PC2-6400 NP DDR2 UDIMM</td><td>41U2978</td></tr> <tr><td>500GB SATA 3.0Gb/s Disk (7200 rpm)</td><td>43R1990</td></tr> <tr><td>USB 2.0 Lenovo Multimedia Headset</td><td>40Y8518</td></tr> <tr><td>USB 2.0 Essential Memory Key 32GB</td><td>45K1258</td></tr> <tr><td>ThinkVision® L2440p Wide 24" Monitor</td><td>4420HB2</td></tr> <tr><td>Wireless Kbd & Opt Wheel Mouse (via USB)</td><td>73P4067</td></tr> <tr><td>Kensington Cable Lock from Lenovo</td><td>73P2582</td></tr> <tr><td>ADD2 DVI-D Monitor Connection (HDCP)</td><td>43R1985</td></tr> <tr><td>ATI™ Radeon™ HD 2400 Pro 128MB</td><td>43R1961</td></tr> <tr><td>ATI Radeon HD 2400 XT 256MB</td><td>43R1962</td></tr> <tr><td>ATI Radeon HD 2600 XT 512MB</td><td>43R1963</td></tr> <tr><td>NVIDIA® Quadro® 256MB NVS 290</td><td>43R1765</td></tr> <tr><td>NVIDIA Quadro 256MB FX 370</td><td>43R1766</td></tr> <tr><td>NVIDIA Quadro 512MB FX 1700</td><td>43R1767</td></tr> </table> <p>Other accessories at lenovo.com/accessories</p>	1GB PC2-5300 CL5 NP DDR2 UDIMM	73P4984	2GB PC2-5300 CL5 NP DDR2 UDIMM	73P4985	1GB PC2-6400 NP DDR2 UDIMM	41U2977	2GB PC2-6400 NP DDR2 UDIMM	41U2978	500GB SATA 3.0Gb/s Disk (7200 rpm)	43R1990	USB 2.0 Lenovo Multimedia Headset	40Y8518	USB 2.0 Essential Memory Key 32GB	45K1258	ThinkVision® L2440p Wide 24" Monitor	4420HB2	Wireless Kbd & Opt Wheel Mouse (via USB)	73P4067	Kensington Cable Lock from Lenovo	73P2582	ADD2 DVI-D Monitor Connection (HDCP)	43R1985	ATI™ Radeon™ HD 2400 Pro 128MB	43R1961	ATI Radeon HD 2400 XT 256MB	43R1962	ATI Radeon HD 2600 XT 512MB	43R1963	NVIDIA® Quadro® 256MB NVS 290	43R1765	NVIDIA Quadro 256MB FX 370	43R1766	NVIDIA Quadro 512MB FX 1700	43R1767
1GB PC2-5300 CL5 NP DDR2 UDIMM	73P4984																																		
2GB PC2-5300 CL5 NP DDR2 UDIMM	73P4985																																		
1GB PC2-6400 NP DDR2 UDIMM	41U2977																																		
2GB PC2-6400 NP DDR2 UDIMM	41U2978																																		
500GB SATA 3.0Gb/s Disk (7200 rpm)	43R1990																																		
USB 2.0 Lenovo Multimedia Headset	40Y8518																																		
USB 2.0 Essential Memory Key 32GB	45K1258																																		
ThinkVision® L2440p Wide 24" Monitor	4420HB2																																		
Wireless Kbd & Opt Wheel Mouse (via USB)	73P4067																																		
Kensington Cable Lock from Lenovo	73P2582																																		
ADD2 DVI-D Monitor Connection (HDCP)	43R1985																																		
ATI™ Radeon™ HD 2400 Pro 128MB	43R1961																																		
ATI Radeon HD 2400 XT 256MB	43R1962																																		
ATI Radeon HD 2600 XT 512MB	43R1963																																		
NVIDIA® Quadro® 256MB NVS 290	43R1765																																		
NVIDIA Quadro 256MB FX 370	43R1766																																		
NVIDIA Quadro 512MB FX 1700	43R1767																																		

See footnotes for important warranty information
US models announced December 4, 2007

↪ US model withdrawn effective September 2008

Name	Type-model	Slot x bay	Processor	GHz	L2 cache	Memory ⁸	SATA disk	SATA optical	Graphics	eSATA port	Intel vPro	Preload	Limited warranty ¹	Global Educ	Avail date
✓	M57	6075-F8U	4x5	Core 2 Duo E4500	2.20	2MB 1GB	160GB ²	DVD	GMA	None	None	XP Pro	3-yr	None	Feb 08
	M57	6075-DMU	4x5	Core 2 Duo E8200	2.66	6MB 1GB	160GB	DVD±RW	GMA	None	None	XP Pro	3-yr	None	Feb 08
✓	M57	6075-F9U	4x5	Core 2 Duo E4500	2.20	2MB 1GB	160GB	DVD	GMA	None	None	Business32	3-yr	None	Feb 08
✓	M57	6075-F4U	4x5	Core 2 Duo E4500	2.20	2MB 1GB	160GB	Combo	GMA	None	None	Business32	3-yr	None	Feb 08
	M57	6075-DLU	4x5	Core 2 Duo E8200	2.66	6MB 1GB	160GB	DVD±RW	GMA	None	None	Business32	3-yr	None	Feb 08

Positioning Processor	<p><i>Ultimate enterprise stability for large enterprise and mid-market</i></p> <p>Intel® Core™ 2 Duo Processor E4500 with dual-core, Intel 64 Technology, Execute Disable Bit, EIST, 800MHz system bus, and 2MB shared L2 cache or Intel Core 2 Duo Processor E8200 with dual-core, Intel 64 Technology, Virtualization Technology, Execute Disable Bit, EIST, TXT, and 1333MHz system bus with 6MB shared L2 cache Processor in FC-LGA6 or FC-LGA8 package in LGA775 socket</p>							<p>Tower</p> <ul style="list-style-type: none"> • Business black color; metal case • 6.9" W X 17.0" D X 15.7" H • 175mm W X 432mm D X 400mm H • 22.5 lb (10.2 kg) in max configuration • Handle on top front • Toolless cover removal • Toolless disk, diskette drive, optical drive removal • Toolless adapter retention 																																													
Implementation	Processor in FC-LGA6 or FC-LGA8 package in LGA775 socket							<p>Bay ① 5.25", 1.6" high, access, std optical</p> <p>Bay ② 5.25", 1.6" high, access, open</p> <p>Bay ③ 3.5", 1" high, access, open (reader/diskette)</p> <p>Bay ④ 3.5", 1" high, no access, std disk</p> <p>Bay ⑤ 3.5", 1" high, no access, opt disk</p>																																													
Memory	<p>1GB std, 8GB max⁸, PC2-5300 667MHz DDR2, non-parity, dual-channel capable, four 240-pin DIMM sockets; <i>Non-italics</i>: standard memory in one socket; 3 sockets available</p>							<p>Slot 1: half-length, full-height, PCI Express x16 (75w max)</p> <p>Slot 2: half-length, full-height, PCI Express x1</p> <p>Slot 3: half-length, full-height, 32-bit PCI 2.3 (5v)</p> <p>Slot 4: half-length, full-height, 32-bit PCI 2.3 (5v)</p>																																													
Graphics	<p>Intel Graphics Media Accelerator 3100 (GMA 3100), integrated graphics in Q35, uses main memory (up to 256MB), one analog VGA DB-15 connector, supports dual independent display with optional ADD2 adapter</p>							<p>Security</p> <ul style="list-style-type: none"> • Security chip (see information on left) • One lock to secure both cover and entire system to fixed object: <ul style="list-style-type: none"> - Padlock loop (in rear for opt padlock) - Security slot (in rear for optional Kensington® Microsaver® cable) • Power-on password • Administrator password • Hard disk password • Boot sequence control • Boot without keyboard, mouse, diskette • Serial port I/O control • Parallel port I/O control • Individual USB port disablement 																																													
SATA disk	<p>160GB, SATA 3.0Gb/s 7200 rpm, vibration dampening mounts</p>							<p>Supports ThinkVantage® technologies</p>																																													
SATA controller	<p>Serial ATA, SATA 3.0Gb/s, integrated in ICH9DO, RAID 0/1 support</p>							<p>RoHS-compliant</p>																																													
SATA DVD	<p><i>Some:</i> DVD-ROM DL SATA 1.5Gb/s 16-48X Max* Drive (41N5618)</p>							<p>Limited Warranty¹</p> <ul style="list-style-type: none"> ↔ 3-year parts and labor ↔ International Warranty Service⁹ ↔ Customer Replaceable Unit (CRU) parts only (with limited onsite service for selected parts³, 8 am - 5 pm, Mon - Fri coverage excluding holidays, next business day response time) ↔ Onsite service upgrade options (in eligible locations):⁷ <ul style="list-style-type: none"> • 3-year LOR 9x5, 4 hour response (ThinkPlus™ part number 41C9192) • 3-year LOR 24x7, 4 hour response (ThinkPlus part number 41C9193) • 4-year LOR 9x5, Next Business Day (ThinkPlus part number 41C9194) • 4-year LOR 9x5, 4 hour response (ThinkPlus part number 41C9195) • 4-year LOR 24x7, 4 hour response (ThinkPlus part number 41C9196) ↔ ThinkPlus services at lenovo.com/thinkplus/warranty ↔ Post warranty maintenance services available ↔ 24 hour x 7 day¹⁴ toll-free support during the warranty period¹ via 800-426-7378 																																													
SATA Combo	<p><i>Some:</i> CD-RW/DVD-ROM Combo SATA 1.5Gb/s Drive</p>																																																				
SATA DVD±RW	<p><i>Some:</i> Super Multi-Burner DL DVD±RW SATA Drive (41N5620)</p>																																																				
SATA cables	<p>Two SATA cables (each 1-drop to device), three SATA connectors and one eSATA/SATA connector on planar</p>																																																				
eSATA port	None																																																				
EIDE controller	None																																																				
Diskette drive	None																																																				
Media reader	None																																																				
Chipset	<p>Intel Q35 Express Chipset; I/O Controller Hub 9 Digital Office (ICH9DO) for SATA 3.0Gb/s with RAID 0/1 support, PCI Express® x1, ethernet (MAC), PCI 2.3, USB, LPC bus / SMSC® SCH5617 Super I/O for serial, parallel, diskette, hardware monitoring (temperature, voltage, fan speed)</p>																																																				
Front ports	Two USB 2.0, microphone (stereo, 3.5mm), headphone (stereo, 3.5mm)																																																				
Rear ports	Six USB 2.0, serial (9-pin), parallel (25-pin), keyboard (PS/2), mouse (PS/2), ethernet (RJ-45), monitor (VGA DB-15)																																																				
Internal connector	Two USB 2.0 planar conn (1 used; one open for media reader or 2 rear USB ports)																																																				
Rear audio ports	Line-in (stereo, 3.5mm), line-out (stereo, 3.5mm), microphone-in (stereo, 3.5mm)																																																				
Audio	High Definition (HD) Audio, Analog Devices AD1882 codec																																																				
Speaker	One internal speaker for business audio																																																				
Ethernet	Gigabit ethernet on planar, Intel 82566DM, PCIe x1, Wake on LAN®, ASF2.0																																																				
Intel AMT	None																																																				
Modem	None																																																				
Security chip	Winbond® WPCT200 SafeKeeper™ Trusted Platform Module, TCG 1.2-compliant																																																				
Keyboard	Preferred Pro USB Keyboard (USB connector), 104-key, black, Lenovo logo																																																				
Mouse	Optical Wheel Mouse (USB connector), black, Lenovo logo																																																				
Power supply	280 watts with variable speed fan, manual switch, two diagnostic LEDs																																																				
Preloaded operating system²⁰	<p>- <i>Some:</i> Microsoft® Windows® XP Professional with Vista® COA</p> <p>- <i>Some:</i> Microsoft Windows Vista Business Edition (32-bit)</p> <p>↔ <i>Vista models:</i> Vista Basic logo</p>																																																				
Preloaded applications⁵ (all OSes; only some listed)	<ul style="list-style-type: none"> • Rescue and Recovery™ • Client Security Solution™ • ThinkVantage Productivity Center • ThinkVantage System Update • System Migration Assistant • Norton Internet Security™ • Diskeeper® Home • PC-Doctor™ (diagnostics) • Adobe® Reader • Picasa from Google • Microsoft Office 2007 Trial (60-day) • Multimedia Center for Think Offerings (DVD, DVD±RW) (XP) • Sonic RecordNow and Drive Letter Access (combo, DVD±RW) • Corel® WinDVD® (combo, DVD, DVD±RW) • Corel WinDVD Creator (DVD±RW) (XP) 							<p>Accessories</p> <table border="0"> <tr><td>1GB PC2-5300 CL5 NP DDR2 UDIMM</td><td>73P4984</td></tr> <tr><td>2GB PC2-5300 CL5 NP DDR2 UDIMM</td><td>73P4985</td></tr> <tr><td>1GB PC2-6400 NP DDR2 UDIMM</td><td>41U2977</td></tr> <tr><td>2GB PC2-6400 NP DDR2 UDIMM</td><td>41U2978</td></tr> <tr><td>250GB SATA 3.0Gb/s Disk (7200 rpm)</td><td>41N3015</td></tr> <tr><td>500GB SATA 3.0Gb/s Disk (7200 rpm)</td><td>43R1990</td></tr> <tr><td>USB 2.0 Lenovo Multimedia Headset</td><td>40Y8518</td></tr> <tr><td>USB 2.0 Lenovo Webcam</td><td>40Y8519</td></tr> <tr><td>USB 2.0 Essential Memory Key 32GB</td><td>45K1258</td></tr> <tr><td>USB 2.0 Ultra Secure Memory Key 8GB</td><td>45J5918</td></tr> <tr><td>USB 2.0 Portable Secure 320GB Hard Disk</td><td>43R2019</td></tr> <tr><td>ThinkVision® L2240p Wide 22" Monitor</td><td>4422HB6</td></tr> <tr><td>ThinkVision L2440p Wide 24" Monitor</td><td>4420HB2</td></tr> <tr><td>Wireless Kbd & Opt Wheel Mouse (via USB)</td><td>73P4067</td></tr> <tr><td>Kensington Cable Lock from Lenovo</td><td>73P2582</td></tr> <tr><td>ADD2 DVI-D Monitor Connection (HDCP)</td><td>43R1985</td></tr> <tr><td>ATI™ Radeon™ HD 2400 Pro 128MB</td><td>43R1961</td></tr> <tr><td>ATI Radeon HD 2400 XT 256MB</td><td>43R1962</td></tr> <tr><td>ATI Radeon HD 2600 XT 512MB</td><td>43R1963</td></tr> <tr><td>NVIDIA® Quadro® 256MB NVS 290</td><td>43R1765</td></tr> <tr><td>NVIDIA Quadro 256MB FX 370</td><td>43R1766</td></tr> <tr><td>NVIDIA Quadro 512MB FX 1700</td><td>43R1767</td></tr> </table> <p>Acc Guide in pdf lenovo.com/accessoriesguide Other accessories at lenovo.com/accessories</p>		1GB PC2-5300 CL5 NP DDR2 UDIMM	73P4984	2GB PC2-5300 CL5 NP DDR2 UDIMM	73P4985	1GB PC2-6400 NP DDR2 UDIMM	41U2977	2GB PC2-6400 NP DDR2 UDIMM	41U2978	250GB SATA 3.0Gb/s Disk (7200 rpm)	41N3015	500GB SATA 3.0Gb/s Disk (7200 rpm)	43R1990	USB 2.0 Lenovo Multimedia Headset	40Y8518	USB 2.0 Lenovo Webcam	40Y8519	USB 2.0 Essential Memory Key 32GB	45K1258	USB 2.0 Ultra Secure Memory Key 8GB	45J5918	USB 2.0 Portable Secure 320GB Hard Disk	43R2019	ThinkVision® L2240p Wide 22" Monitor	4422HB6	ThinkVision L2440p Wide 24" Monitor	4420HB2	Wireless Kbd & Opt Wheel Mouse (via USB)	73P4067	Kensington Cable Lock from Lenovo	73P2582	ADD2 DVI-D Monitor Connection (HDCP)	43R1985	ATI™ Radeon™ HD 2400 Pro 128MB	43R1961	ATI Radeon HD 2400 XT 256MB	43R1962	ATI Radeon HD 2600 XT 512MB	43R1963	NVIDIA® Quadro® 256MB NVS 290	43R1765	NVIDIA Quadro 256MB FX 370	43R1766	NVIDIA Quadro 512MB FX 1700	43R1767
1GB PC2-5300 CL5 NP DDR2 UDIMM	73P4984																																																				
2GB PC2-5300 CL5 NP DDR2 UDIMM	73P4985																																																				
1GB PC2-6400 NP DDR2 UDIMM	41U2977																																																				
2GB PC2-6400 NP DDR2 UDIMM	41U2978																																																				
250GB SATA 3.0Gb/s Disk (7200 rpm)	41N3015																																																				
500GB SATA 3.0Gb/s Disk (7200 rpm)	43R1990																																																				
USB 2.0 Lenovo Multimedia Headset	40Y8518																																																				
USB 2.0 Lenovo Webcam	40Y8519																																																				
USB 2.0 Essential Memory Key 32GB	45K1258																																																				
USB 2.0 Ultra Secure Memory Key 8GB	45J5918																																																				
USB 2.0 Portable Secure 320GB Hard Disk	43R2019																																																				
ThinkVision® L2240p Wide 22" Monitor	4422HB6																																																				
ThinkVision L2440p Wide 24" Monitor	4420HB2																																																				
Wireless Kbd & Opt Wheel Mouse (via USB)	73P4067																																																				
Kensington Cable Lock from Lenovo	73P2582																																																				
ADD2 DVI-D Monitor Connection (HDCP)	43R1985																																																				
ATI™ Radeon™ HD 2400 Pro 128MB	43R1961																																																				
ATI Radeon HD 2400 XT 256MB	43R1962																																																				
ATI Radeon HD 2600 XT 512MB	43R1963																																																				
NVIDIA® Quadro® 256MB NVS 290	43R1765																																																				
NVIDIA Quadro 256MB FX 370	43R1766																																																				
NVIDIA Quadro 512MB FX 1700	43R1767																																																				

See footnotes for important warranty information
US models announced January 22, 2008

↔ US models withdrawn effective September 2008

Name	Type-model	Slot x bay	Processor	GHz	L2 cache	Memory ⁶	SATA disk	SATA optical	Graphics	eSATA port	Intel vPro	Preload	Limited warranty ¹	Global Educ	Avail date
M57	6075-GAU	4x5	Pentium E2200	2.20	1MB	1GB	160GB ²	DVD	GMA	None	None	XP Pro	3-yr	None	Aug 08
M57	6075-GBU	4x5	Pentium E2200	2.20	1MB	2GB	160GB	DVD±RW	GMA+ADD2	None	None	XP Pro	3-yr	None	Aug 08
M57	6075-GCU	4x5	Core 2 Duo E7200	2.53	3MB	1GB	160GB	DVD±RW	GMA+ADD2	None	None	XP Pro	3-yr	None	Aug 08
M57	6075-GEU	4x5	Core 2 Duo E7200	2.53	3MB	2GB	160GB	DVD	GMA	None	None	XP Pro	3-yr	None	Aug 08
M57	6075-GDU	4x5	Core 2 Duo E7300	2.66	3MB	2GB	250GB	DVD±RW	GMA	None	None	XP Pro	3-yr	None	Aug 08
M57	6075-G9U	4x5	Core 2 Quad Q9300	2.50	6MB	2GB	320GB	DVD±RW	2400XT	None	None	XP Pro	3-yr	None	Aug 08
M57	6075-G5U	4x5	Core 2 Duo E7200	2.53	3MB	1GB	160GB	DVD	GMA	None	None	Bus32	3-yr	None	Aug 08
M57	6075-G7U	4x5	Core 2 Duo E7200	2.53	3MB	1GB	160GB	DVD±RW	GMA+ADD2	None	None	Bus32	3-yr	None	Aug 08
M57	6075-G6U	4x5	Core 2 Duo E7200	2.53	3MB	2GB	160GB	DVD±RW	GMA	None	None	Bus32	3-yr	None	Aug 08
M57	6075-G8U	4x5	Core 2 Duo E7300	2.66	3MB	2GB	250GB	DVD±RW	GMA+ADD2	None	None	Bus32	3-yr	None	Aug 08
Positioning Processor	<p><i>Ultimate enterprise stability for large enterprise and mid-market</i> Intel® Pentium® Dual-Core Processor E2200 with dual-core, Intel 64 Technology, Execute Disable Bit, EIST, 800MHz system bus, and 1MB shared L2 cache or Intel Core™ 2 Duo Processor E7200 or E7300 with dual-core, Intel 64 Technology, Execute Disable Bit, EIST, 1066MHz system bus, and 3MB shared L2 cache or Intel Core 2 Quad Processor Q9300 with quad-core (dual-core on dual-die), Intel 64 Technology, Virtualization Technology, Execute Disable Bit, EIST, TXT, and 1333MHz system bus with 6MB shared L2 cache Processor in FC-LGA6 or FC-LGA8 package in LGA775 socket</p>									<p>Tower</p> <ul style="list-style-type: none"> • Business black color; metal case • 6.9" W X 17.0" D X 15.7" H • 175mm W X 432mm D X 400mm H • 22.5 lb (10.2 kg) in max configuration • Handle on top front • Toolless cover removal • Toolless disk, diskette drive, optical drive removal • Toolless adapter retention 					
Implementation	<p>Processor in FC-LGA6 or FC-LGA8 package in LGA775 socket</p>									<p>Bay ① 5.25", 1.6" high, access, std optical Bay ② 5.25", 1.6" high, access, open Bay ③ 3.5", 1" high, access, open (reader/diskette) Bay ④ 3.5", 1" high, no access, std disk Bay ⑤ 3.5", 1" high, no access, opt disk</p>					
Memory	<p>1GB or 2GB std, 8GB max⁸, PC2-5300 667MHz DDR2, non-parity, dual-channel capable, four 240-pin DIMM sockets; <i>Italics:</i> standard memory in two sockets; two sockets available; <i>Non-italics:</i> standard memory in one socket; 3 sockets available</p>									<p>Slot ① half-length, full-height, PCI Express x16 (75w max)* Slot ② half-length, full-height, PCI Express x1 Slot ③ half-length, full-height, 32-bit PCI 2.3 (5v) Slot ④ half-length, full-height, 32-bit PCI 2.3 (5v) * used in some models</p>					
Graphics	<p><i>Some:</i> Intel Graphics Media Accelerator 3100 (GMA 3100), integrated graphics in Q35, uses main memory (up to 256MB), one analog VGA DB-15 connector <i>Some:</i> ADD2 DVI-D Monitor Connection (HDCP), PCI Express[®] adapter in PCIe x16 slot, provides DVI-D connector to support second monitor, HDCP-compliant <i>Some:</i> ATI™ Radeon™ HD 2400 XT, PCI Express x16 adapter, 256MB, dual-head support, VGA and DVI-I connectors via dongle, S-Video out for TV-out, HDCP, DirectX[®] 10, ATI Avivo™, dual-link DVI, 35 watts</p>									<p>Security</p> <ul style="list-style-type: none"> • Security chip (see information on left) • One lock to secure both cover and entire system to fixed object: <ul style="list-style-type: none"> - Padlock loop (in rear for opt padlock) - Security slot (in rear for optional Kensington[®] Microsaver[®] cable) • Power-on password • Administrator password • Hard disk password • Boot sequence control • Boot without keyboard, mouse, diskette • Serial port I/O control • Parallel port I/O control • Individual USB port disablement 					
SATA disk	<p>160GB, 250GB, or 320GB, SATA 3.0Gb/s 7200 rpm, vibration dampening mounts</p>									<p>Supports ThinkVantage[®] technologies</p>					
SATA controller	<p>Serial ATA, SATA 3.0Gb/s, integrated in ICH9DO, RAID 0/1 support</p>														
SATA DVD	<p><i>Some:</i> DVD-ROM DL SATA 1.5Gb/s 16-48X Max⁴ Drive (41N5618)</p>									<p>RoHS-compliant</p>					
SATA DVD±RW	<p><i>Some:</i> Super Multi-Burner DL DVD±RW SATA 1.5Gb/s Drive (41N5620)</p>														
SATA cables	<p>Two SATA cables (each 1-drop to device), three SATA connectors and one eSATA/SATA connector on panel</p>									<p>Limited Warranty¹</p> <ul style="list-style-type: none"> ↔ 3-year parts and labor ↔ International Warranty Service⁹ ↔ Customer Replaceable Unit (CRU) parts only (with limited onsite service for selected parts³, 8 am - 5 pm, Mon - Fri coverage excluding holidays, next business day response time) ↔ Onsite service upgrade options (in eligible locations):⁷ <ul style="list-style-type: none"> • 3-year LOR 9x5, 4 hour response (ThinkPlus[™] part number 41C9192) • 3-year LOR 24x7, 4 hour response (ThinkPlus part number 41C9193) • 4-year LOR 9x5, Next Business Day (ThinkPlus part number 41C9194) • 4-year LOR 9x5, 4 hour response (ThinkPlus part number 41C9195) • 4-year LOR 24x7, 4 hour response (ThinkPlus part number 41C9196) ↔ ThinkPlus services at lenovo.com/thinkplus/warranty ↔ 24 hour x 7 day¹⁴ toll-free support during the warranty period¹ via 800-426-7378 					
eSATA port	None														
EIDE controller	None														
Diskette drive	None														
Media reader	None														
Chipset	<p>Intel Q35 Express Chipset; I/O Controller Hub 9 Digital Office (ICH9DO) for SATA 3.0Gb/s with RAID 0/1 support, PCI Express x1, ethernet (MAC), PCI 2.3, USB, LPC bus / SMSC[®] SCH5617 Super I/O for serial, parallel, diskette, hardware monitoring (temperature, voltage, fan speed)</p>														
Front ports	Two USB 2.0, microphone (stereo, 3.5mm), headphone (stereo, 3.5mm)														
Rear ports	Six USB 2.0, serial (9-pin), parallel (25-pin), keyboard (PS/2), mouse (PS/2), ethernet (RJ-45), G9U: monitor (VGA DB-15, DVI-I), S-Video out; Others: monitor (VGA DB-15, DVI-D in some models)														
Internal connector	Two USB 2.0 planar conn (1 used; one open for media reader or 2 rear USB ports)														
Rear audio ports	Line-in (stereo, 3.5mm), line-out (stereo, 3.5mm), microphone-in (stereo, 3.5mm)														
Audio	High Definition (HD) Audio, Analog Devices AD1882 codec														
Speaker	One internal speaker for business audio														
Ethernet	Gigabit ethernet on planar, Intel 82566DM, PCIe x1, Wake on LAN [®] , ASF2.0														
Intel AMT	None														
Modem	None														
Security chip	Winbond [®] WPCT200 SafeKeeper™ Trusted Platform Module, TCG 1.2-compliant														
Keyboard	Preferred Pro USB Keyboard (USB connector), 104-key, black, Lenovo logo														
Mouse	Optical Wheel Mouse (USB connector), black, Lenovo logo														
Power supply	280 watts with variable speed fan, manual switch, two diagnostic LEDs														
Preloaded operating system²⁰			Accessories												
- <i>Some:</i> Microsoft [®] Windows [®] XP Professional with Vista [®] COA			1GB PC2-6400 NP DDR2 UDIMM			41U2977									
- <i>Some:</i> Microsoft Windows Vista Business Edition (32-bit)			2GB PC2-6400 NP DDR2 UDIMM			41U2978									
↔ <i>Vista models:</i> Vista Premium logo			ADD2 DVI-D Monitor Connection (HDCP)			43R1985									
Preloaded applications⁵ (all OSes; only some listed)			ATI™ Radeon™ HD 2400 Pro 128MB			43R1961									
• Rescue and Recovery™			ATI Radeon HD 2400 XT 256MB			43R1962									
• Norton Internet Security™			ATI Radeon HD 2600 XT 512MB			43R1963									
• Microsoft Office 2007 Trial (60-day)			NVIDIA [®] Quadro [®] 256MB NVS 290			43R1765									
			NVIDIA Quadro 256MB FX 370			43R1766									
			NVIDIA Quadro 512MB FX 1700			43R1767									
			Other accessories at lenovo.com/accessories												

See footnotes for important warranty information
 US models announced August 19, 2008

Name	Type-model	Slot x bay	Processor	GHz	L2 cache	Memory ⁸	SATA disk	SATA optical	Graphics	eSATA port	ENERGY STAR 4.0	Intel vPro	Vista preload	Vista logo	Global Educ	Avail date
ES	M57	9174-A2U	4x5 Pentium E2180	2.00	1MB	2GB	160GB ²	DVD±RW	GMA+ADD2	None	ES40	None	Bus32	Prem	Gbl	Dec 07
	M57	9174-A1U	4x5 Core 2 Duo E6550	2.33	4MB	1GB	160GB	Combo	GMA	None	ES40	None	Bus32	Basic		Oct 07

• These models have a 3-year limited warranty¹

Positioning Processor	Ultimate enterprise stability for large enterprise and mid-market Intel® Pentium® Dual-Core Processor E2180 with dual-core, Intel 64 Technology, Execute Disable Bit, EIST, 800MHz system bus, and 1MB shared L2 cache or Intel Core™ 2 Duo Processor E6550 with dual-core, Intel 64 Technology, Virtualization Technology, Execute Disable Bit, EIST, TXT, and 1333MHz system bus with 4MB shared L2 cache Processor in FC-LGA6 package in LGA775 socket										Tower	
Implementation											<ul style="list-style-type: none"> • Business black color; metal case • 6.9" W X 17.0" D X 15.7" H • 175mm W X 432mm D X 400mm H • 22.5 lb (10.2 kg) in max configuration • Handle on top front • Toolless cover removal • Toolless disk, diskette drive, optical drive removal • Toolless adapter retention 	
Memory	1GB or 2GB std, 8GB max ⁸ , PC2-5300 667MHz DDR2, non-parity, dual-channel capable, four 240-pin DIMM sockets; <i>Italics:</i> standard memory in two sockets; two sockets available; <i>Non-italics:</i> standard memory in one socket; 3 sockets available										Bay ① 5.25", 1.6" high, access, std optical Bay ② 5.25", 1.6" high, access, open Bay ③ 3.5", 1" high, access, open (reader/diskette) Bay ④ 3.5", 1" high, no access, std disk Bay ⑤ 3.5", 1" high, no access, opt disk Slot 1: half-length, full-height, PCI Express x16 (75w max) [*] Slot 2: half-length, full-height, PCI Express x1 Slot 3: half-length, full-height, 32-bit PCI 2.3 (5v) Slot 4: half-length, full-height, 32-bit PCI 2.3 (5v)	
Graphics	All: Intel Graphics Media Accelerator 3100 (GMA 3100), integrated graphics in Q35, uses main memory (up to 256MB), one analog VGA DB-15 connector Some: ADD2 DVI-D Monitor Connection (HDCP), PCI Express® adapter in PCIe x16 slot, provides DVI-D connector to support second monitor, HDCP-compliant										* used in some models	
SATA disk	160GB, SATA 3.0Gb/s 7200 rpm, vibration dampening mounts											
SATA controller	Serial ATA, SATA 3.0Gb/s, integrated in ICH9DO, RAID 0/1 support											
SATA Combo	Some: CD-RW/DVD-ROM Combo SATA 1.5Gb/s Drive											
SATA DVD±RW	Some: Super Multi-Burner DL DVD±RW SATA 1.5Gb/s Drive (41N5620)											
SATA cables	Two SATA cables (each 1-drop to device), three SATA connectors and one eSATA/SATA connector on planar											
eSATA port	None											
EIDE controller	None											
Diskette drive	None											
Media reader	None											
Chipset	Intel Q35 Express Chipset; I/O Controller Hub 9 Digital Office (ICH9DO) for SATA 3.0Gb/s with RAID 0/1 support, PCI Express x1, ethernet (MAC), PCI 2.3, USB, LPC bus / SMSC® SCH5617 Super I/O for serial, parallel, diskette, hardware monitoring (temperature, voltage, fan speed)											
Front ports	Two USB 2.0, microphone (stereo, 3.5mm), headphone (stereo, 3.5mm)											
Rear ports	Six USB 2.0, serial (9-pin), parallel (25-pin), keyboard (PS/2), mouse (PS/2), ethernet (RJ-45), monitor (VGA DB-15, DVI-D in some models)											
Internal connector	Two USB 2.0 planar conn (1 used; one open for media reader or 2 rear USB ports)											
Rear audio ports	Line-in (stereo, 3.5mm), line-out (stereo, 3.5mm), microphone-in (stereo, 3.5mm)											
Audio	High Definition (HD) Audio, Analog Devices AD1882 codec											
Speaker	One internal speaker for business audio											
Ethernet	Gigabit ethernet on planar, Intel 82566DM, PCIe x1, Wake on LAN®, ASF2.0											
Intel AMT	None											
Modem	None											
Security chip	Winbond® WPCT200 SafeKeeper™ Trusted Platform Module, TCG 1.2-compliant											
Keyboard	Preferred Pro USB Keyboard (USB connector), 104-key, black, Lenovo logo											
Mouse	Optical Wheel Mouse (USB connector), black, Lenovo logo											
Power supply	280 watts with variable speed fan, autosensing, two diagnostic LEDs, 80% PSU											
Preloaded operating system ²⁰	- Microsoft® Windows® Vista® Business Edition (32-bit)											
Preloaded applications ⁵	<ul style="list-style-type: none"> • Rescue and Recovery™ • Client Security Solution™ • ThinkVantage Productivity Center • ThinkVantage System Update • System Migration Assistant • Norton Internet Security™ (90 days of virus definitions) • Diskeeper® Home • PC-Doctor™ (diagnostics) • Adobe® Reader • Windows Live™ Toolbar • Windows Live Search • Picasa from Google • Microsoft Office 2007 Trial (60-day) • Sonic RecordNow and Drive Letter Access (combo, DVD±RW) • Corel® WinDVD® (combo, DVD±RW) 											
Accessories	1GB PC2-5300 CL5 NP DDR2 UDIMM 73P4984 2GB PC2-5300 CL5 NP DDR2 UDIMM 73P4985 1GB PC2-6400 NP DDR2 UDIMM 41U2977 2GB PC2-6400 NP DDR2 UDIMM 41U2978 250GB SATA 3.0Gb/s Disk (7200 rpm) 41N3015 500GB SATA 3.0Gb/s Disk (7200 rpm) 43R1990 USB 2.0 Lenovo Multimedia Headset 40Y8518 USB 2.0 Lenovo Webcam 40Y8519 USB 2.0 Essential Memory Key 32GB 45K1258 USB 2.0 Ultra Secure Memory Key 8GB 45J5918 USB 2.0 Portable Secure 320GB Hard Disk 43R2019 USB 2.0 Super Multi-Burner Drive 41N5565 ThinkVision® L2240p Wide 22" Monitor 4422HB6 ThinkVision L2440p Wide 24" Monitor 4420HB2 Wireless Kbd & Opt Wheel Mouse (via USB) 73P4067 Kensington Cable Lock from Lenovo 73P2582 ADD2 DVI-D Monitor Connection (HDCP) 43R1985 ATI™ Radeon™ HD 2400 Pro 128MB 43R1961 ATI Radeon HD 2400 XT 256MB 43R1962 ATI Radeon HD 2600 XT 512MB 43R1963 NVIDIA® Quadro® 256MB NVS 290 43R1765 NVIDIA Quadro 256MB FX 370 43R1766 NVIDIA Quadro 512MB FX 1700 43R1767 Acc Guide in pdf lenovo.com/accessoriesguide Other accessories at lenovo.com/accessories											
											Security <ul style="list-style-type: none"> • Security chip (see information on left) • One lock to secure both cover and entire system to fixed object: <ul style="list-style-type: none"> - Padlock loop (in rear for opt padlock) - Security slot (in rear for optional Kensington® Microsaver® cable) • Power-on password • Administrator password • Hard disk password • Boot sequence control • Boot without keyboard, mouse, diskette • Serial port I/O control • Parallel port I/O control • Individual USB port disablement 	
											Supports ThinkVantage® technologies	
											EPEAT™ Gold rating ENERGY STAR 4.0-compliant RoHS-compliant	
											Limited Warranty ¹ <ul style="list-style-type: none"> ↪ 3-year parts and labor ↪ International Warranty Service⁹ ↪ Customer Replaceable Unit (CRU) parts only (with limited onsite service for selected parts³, 8 am - 5 pm, Mon - Fri coverage excluding holidays, next business day response time) ↪ Onsite service upgrade options (in eligible locations):⁷ <ul style="list-style-type: none"> • 3-year LOR 9x5, 4 hour response (ThinkPlus™ part number 41C9192) • 3-year LOR 24x7, 4 hour response (ThinkPlus part number 41C9193) • 4-year LOR 9x5, Next Business Day (ThinkPlus part number 41C9194) • 4-year LOR 9x5, 4 hour response (ThinkPlus part number 41C9195) • 4-year LOR 24x7, 4 hour response (ThinkPlus part number 41C9196) ↪ ThinkPlus services at lenovo.com/thinkplus/warranty ↪ Post warranty maintenance services available ↪ 24 hour x 7 day¹⁴ toll-free support during the warranty period¹ via 800-426-7378 	

See footnotes for important warranty information

ES US model announced December 4, 2007; previous model on September 18, 2007

Name	Type-model	Slot x bay	Processor	GHz	L2 cache	Memory ⁸	SATA disk	EIDE optical	Graphics	eSATA port	Intel vPro	Floor stand	Vista preload	Vista logo	Global Educ	Avail date
M57p	9071-ABU	1x2	Core 2 Duo E6550	2.33	4MB	1GB	80GB ²	Combo	GMA	eSATA	vPro	Stand	Bus32	Basic		Oct 07
M57p	9071-A8U	1x2	Core 2 Duo E6550	2.33	4MB	1GB	80GB	Combo	GMA	eSATA	vPro		Bus32	Basic	Gbl	Oct 07
M57p	9071-AAU	1x2	Core 2 Duo E6550	2.33	4MB	1GB	160GB	Combo	GMA	eSATA	vPro	Stand	Bus32	Premium		Oct 07
M57p	9071-A2U	1x2	Core 2 Duo E6750	2.66	4MB	1GB	160GB	DVD±RW	GMA	eSATA	vPro	Stand	Bus32	Basic		Oct 07
M57p	9071-ANU	1x2	Core 2 Duo E6750	2.66	4MB	2GB	160GB	DVD±RW	GMA	eSATA	vPro	Stand	Bus32	Premium		Feb 08

- Intel Core 2 Processor with vPro™ Technology (includes Intel Active Management Technology)
- These models have a 3-year limited warranty¹

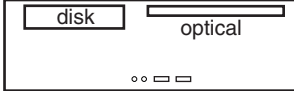
Positioning	<i>Ultimate enterprise stability and manageability for large enterprise</i>		Ultra Small	
Processor	Intel® Core™ 2 Duo Processor E6550 or E6750 with dual-core, Intel 64 Technology, Virtualization Technology, Execute Disable Bit, EIST, TXT, and 1333MHz system bus with 4MB shared L2 cache Processor in FC-LGA6 package in LGA775 socket			
Implementation	Processor in FC-LGA6 package in LGA775 socket			
Memory	1GB or 2GB std, 4GB max⁸, PC2-5300 667MHz DDR2 , non-parity, dual-channel capable, two 240-pin DIMM sockets; <i>Italics:</i> standard memory in both sockets; no sockets avail; <i>Non-italics:</i> standard memory in one socket; one socket available		Bay ① 3.5", 1" high, no access, std disk (desktop) Bay ② 5.25", *.5" high, access, std optical (notebook)	* Optical bay is Ultrabay™ Enhanced 12.7mm high (uses select ThinkPad-based Ultrabay Enhanced [12.7mm high] and Ultrabay Slim [9.5mm high] devices)
Graphics	Intel Graphics Media Accelerator 3100 (GMA 3100) , integrated graphics in Q35, uses main memory (up to 256MB), one analog VGA DB-15 connector		Slot 1: half-length (175mm), full-height, 32-bit PCI 2.3 (5v)	<ul style="list-style-type: none"> • Business black color; metal case • 10.9" W X 10.7" D X 3.5" H • 276mm W X 273mm D X 89mm H • 14.1 lb (6.4 kg) in maximum configuration • Toolless cover flips up and tilts backward on rear hinges • Toolless disk and optical drive removal • Bays 1 and 2 flip up (latched and pivoting) • Toolless PCI slot and riser card retention • Steel chassis supports 100 lb (45kg) monitor on top • <i>Some:</i> system floor stand for vertical orientation
SATA disk	80GB or 160GB , SATA 3.0Gb/s 7200 rpm, vibration dampening			
SATA controller	Serial ATA, SATA 3.0Gb/s, integrated in ICH9DO			
SATA cables	One SATA cable (1-drop to disk), one SATA connector on planar			
eSATA port	One external SATA (eSATA) port			
EIDE Combo	<i>Some:</i> 24X/24X/24X/8X Max ¹¹ CD-RW/DVD-ROM Combo Drive, Ultrabay Enhanced (12.7mm high)			
EIDE DVD±RW	<i>Some:</i> Multi-Burner DL DVD±RW Drive, Ultrabay Enhanced (12.7mm high)			
EIDE controller	Enhanced IDE, ATA-133, via EIDE bridge Silicon Image™ SIL3811 from ICH9DO			
EIDE cables	One cable (one 1-drop Ultrabay Enhanced cable to optical), one EIDE connector (Ultrabay Enhanced) on systemboard			
Diskette drive	None			
Media reader	None			
Chipset	Intel Q35 Express Chipset; I/O Controller Hub 9 Digital Office (ICH9DO) for SATA 3.0Gb/s, PCI Express® x1, ethernet (MAC), PCI 2.3, USB, LPC bus / SMSC® SCH5617 Super I/O for serial, parallel, diskette, hardware monitoring (temperature, voltage, fan speed)			
Front ports	Two USB 2.0, microphone (stereo, 3.5mm), headphone (stereo, 3.5mm)			
Rear ports	Six USB 2.0, serial (9-pin), parallel (25-pin), ethernet (RJ-45), monitor (VGA DB-15), eSATA			
Rear audio ports	Line-in (stereo, 3.5mm), line-out (stereo, 3.5mm)			
Audio	High Definition (HD) Audio, Analog Devices AD1882 codec			
Speaker	One internal speaker for business audio			
Ethernet	Gigabit ethernet on planar, Intel 82566DM (PHY layer; MAC in ICH9DO), PCIe x1, Intel AMT 3.0, Wake on LAN®, ASF2.0			
Intel AMT	Intel Active Management Technology (iAMT)			
Modem	None			
Security chip	Winbond® WPCT200 SafeKeeper™ Trusted Platform Module, TCG 1.2-compliant			Security <ul style="list-style-type: none"> • Security chip (see information on left) • Security slot (in rear for attachment of optional Kensington® Microsaver® cable) - optional cable also locks the cover by deactivating the cover release buttons • Power-on password • Administrator password • Hard disk password • Boot sequence control • Boot without keyboard, mouse • Serial port I/O control • Parallel port I/O control • Individual USB port disablement • eSATA port disablement
Keyboard	Preferred Pro USB Keyboard (USB connector), 104-key, black, Lenovo logo			Supports ThinkVantage® technologies
Mouse	Optical Wheel Mouse (USB connector), black, Lenovo logo			RoHS-compliant
Power supply	225 watts with variable speed fan, autosensing, two diagnostic LEDs			Limited Warranty¹ <ul style="list-style-type: none"> ↪ 3-year parts and labor ↪ International Warranty Service⁹ ↪ Customer Replaceable Unit (CRU) parts only (with limited onsite service for selected parts³, 8 am - 5 pm, Mon - Fri coverage excluding holidays, next business day response time) ↪ Onsite service upgrade options (in eligible locations):⁷ <ul style="list-style-type: none"> • 3-year LOR 9x5, 4 hour response (ThinkPlus™ part number 41C9192) • 3-year LOR 24x7, 4 hour response (ThinkPlus part number 41C9193) • 4-year LOR 9x5, Next Business Day (ThinkPlus part number 41C9194) • 4-year LOR 9x5, 4 hour response (ThinkPlus part number 41C9195) • 4-year LOR 24x7, 4 hour response (ThinkPlus part number 41C9196) ↪ ThinkPlus services at lenovo.com/thinkplus/warranty ↪ Post warranty maintenance services available ↪ 24 hour x 7 day¹⁴ toll-free support during the warranty period¹ via 800-426-7378
Preloaded operating system²⁰	- Microsoft® Windows® Vista® Business Edition (32-bit)		Accessories	
			1GB PC2-5300 CL5 NP DDR2 UDIMM	73P4984
			2GB PC2-5300 CL5 NP DDR2 UDIMM	73P4985
			1GB PC2-6400 NP DDR2 UDIMM	41U2977
			2GB PC2-6400 NP DDR2 UDIMM	41U2978
			250GB SATA 3.0Gb/s Disk (7200 rpm)	41N3015
			500GB SATA 3.0Gb/s Disk (7200 rpm)	43R1990
			USB Portable Diskette Drive	05K9276
			USB 2.0 Lenovo Multimedia Headset	40Y8518
			USB 2.0 Lenovo Webcam	40Y8519
			USB 2.0 Essential Memory Key 32GB	45K1258
			USB 2.0 Ultra Secure Memory Key 8GB	45J5918
			USB 2.0 Portable 160GB Hard Disk	43R1784
			USB 2.0 Portable Secure 320GB Hard Disk	43R2019
			USB 2.0 Super Multi-Burner Drive	41N5565
			ThinkVision® L1940p Wide 19" Monitor	4424HB6
			ThinkVision L2240p Wide 22" Monitor	4422HB6
			ThinkVision L2440p Wide 24" Monitor	4420HB2
			ThinkCentre Ultra Small Under Desk Mount	40Y8625
			Wireless Kbd & Opt Wheel Mouse (via USB)	73P4067
			Laser Tilt Wheel Mouse (USB, PS/2)	41U3074
			Kensington Cable Lock from Lenovo	73P2582
			Acc Guide in pdf lenovo.com/accessoriesguide	
			Other accessories at lenovo.com/accessories	

See footnotes for important warranty information

¹⁸ US model announced February 5, 2008; previous models on September 18, 2007

Name	Type-model	Slot x bay	Processor	GHz	L2 cache	Memory ⁸	SATA disk	EIDE optical	Graphics	eSATA port	Intel vPro	Preload	Limited warranty ¹	Global Educ	Avail date
M57p	9071-AGU	1x2	Core 2 Duo E8200	2.66	6MB	1GB	160GB ²	Combo	GMA	eSATA	vPro	XP Pro	3-yr	None	Feb 08
M57p	9071-AFU	1x2	Core 2 Duo E8200	2.66	6MB	1GB	160GB	Combo	GMA	eSATA	vPro	Business ³²	3-yr	None	Feb 08

- Intel Core 2 Processor with vPro™ Technology (includes Intel Active Management Technology)
- These models have a 3-year limited warranty¹

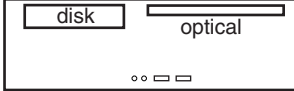
Positioning Processor	Ultimate enterprise stability and manageability for large enterprise Intel® Core™ 2 Duo Processor E8200 with dual-core, Intel 64 Technology, Virtualization Technology, Execute Disable Bit, EIST, TXT, and 1333MHz system bus with 6MB shared L2 cache Processor in FC-LGA8 package in LGA775 socket		Ultra Small			
Implementation	1GB std, 4GB max ⁸ , PC2-5300 667MHz DDR2, non-parity, dual-channel capable, two 240-pin DIMM sockets; <i>Non-italics</i> : standard memory in one socket; one socket available		Bay ① 3.5", 1" high, no access, std disk (desktop) Bay ② 5.25", *.5 high", access, std optical (notebook)		* Optical bay is Ultrabay™ Enhanced 12.7mm high (uses select ThinkPad-based Ultrabay Enhanced [12.7mm high] and Ultrabay Slim [9.5mm high] devices)	
Memory	Intel Graphics Media Accelerator 3100 (GMA 3100), integrated graphics in Q35, uses main memory (up to 256MB), one analog VGA DB-15 connector		Slot 1: half-length (175mm), full-height, 32-bit PCI 2.3 (5v)		<ul style="list-style-type: none"> • Business black color; metal case • 10.9" W X 10.7" D X 3.5" H • 276mm W X 273mm D X 89mm H • 14.1 lb (6.4 kg) in maximum configuration • Toolless cover flips up and tilts backward on rear hinges • Toolless disk and optical drive removal • Bays 1 and 2 flip up (latched and pivoting) • Toolless PCI slot and riser card retention • Steel chassis supports 100 lb (45kg) monitor on top • System floor stand for vertical orientation 	
Graphics	SATA disk 160GB, SATA 3.0Gb/s 7200 rpm, vibration dampening mounts SATA controller Serial ATA, SATA 3.0Gb/s, integrated in ICH9DO SATA cables One SATA cable (1-drop to disk), one SATA connector on planar eSATA port One external SATA (eSATA) port EIDE Combo 24X/24X/8X Max ¹¹ CD-RW/DVD-ROM Combo Drive, Ultrabay Enhanced (12.7mm high)		<ul style="list-style-type: none"> • Business black color; metal case • 10.9" W X 10.7" D X 3.5" H • 276mm W X 273mm D X 89mm H • 14.1 lb (6.4 kg) in maximum configuration • Toolless cover flips up and tilts backward on rear hinges • Toolless disk and optical drive removal • Bays 1 and 2 flip up (latched and pivoting) • Toolless PCI slot and riser card retention • Steel chassis supports 100 lb (45kg) monitor on top • System floor stand for vertical orientation 		<p>Security</p> <ul style="list-style-type: none"> • Security chip (see information on left) • Security slot (in rear for attachment of optional Kensington® Microsaver® cable) - optional cable also locks the cover by deactivating the cover release buttons • Power-on password • Administrator password • Hard disk password • Boot sequence control • Boot without keyboard, mouse • Serial port I/O control • Parallel port I/O control • Individual USB port disablement • eSATA port disablement 	
EIDE controller	Enhanced IDE, ATA-133, via EIDE bridge Silicon Image™ SIL3811 from ICH9DO					
EIDE cables	One cable (one 1-drop Ultrabay Enhanced cable to optical), one EIDE connector (Ultrabay Enhanced) on systemboard					
Diskette drive	None					
Media reader	None					
Chipset	Intel Q35 Express Chipset; I/O Controller Hub 9 Digital Office (ICH9DO) for SATA 3.0Gb/s, PCI Express® x1, ethernet (MAC), PCI 2.3, USB, LPC bus / SMSC® SCH5617 Super I/O for serial, parallel, diskette, hardware monitoring (temperature, voltage, fan speed)					
Front ports	Two USB 2.0, microphone (stereo, 3.5mm), headphone (stereo, 3.5mm)					
Rear ports	Six USB 2.0, serial (9-pin), parallel (25-pin), ethernet (RJ-45), monitor (VGA DB-15), eSATA					
Rear audio ports	Line-in (stereo, 3.5mm), line-out (stereo, 3.5mm)					
Audio	High Definition (HD) Audio, Analog Devices AD1882 codec					
Speaker	One internal speaker for business audio					
Ethernet	Gigabit ethernet on planar, Intel 82566DM (PHY layer; MAC in ICH9DO), PCIe x1, Intel AMT 3.0, Wake on LAN®, ASF2.0					
Intel AMT	Intel Active Management Technology (iAMT)					
Modem	None					
Security chip	Winbond® WPCT200 SafeKeeper™ Trusted Platform Module, TCG 1.2-compliant					
Keyboard	Preferred Pro USB Keyboard (USB connector), 104-key, black, Lenovo logo					
Mouse	Optical Wheel Mouse (USB connector), black, Lenovo logo					
Power supply	225 watts with variable speed fan, autosenesing, two diagnostic LEDs				Supports ThinkVantage® technologies	
Preloaded operating system²⁰	<ul style="list-style-type: none"> - <i>Some:</i> Microsoft® Windows® XP Professional with Vista® COA - <i>Some:</i> Microsoft Windows Vista Business Edition (32-bit) ◇ <i>Vista model:</i> Vista Basic logo 		Accessories		RoHS-compliant	
Preloaded applications⁵ (all OSes)	<ul style="list-style-type: none"> • Rescue and Recovery™ • Client Security Solution™ • ThinkVantage Productivity Center • ThinkVantage System Update • System Migration Assistant • Norton Internet Security™ (90 days of virus definitions) • Diskeeper® Home • PC-Doctor™ (diagnostics) • Adobe® Reader • Windows Live™ Toolbar • Windows Live Search • Picasa from Google • Microsoft Office 2007 Trial (60-day) • Multimedia Center for Think Offerings (combo) (XP) • Sonic RecordNow and Drive Letter Access (combo) • Corel® WinDVD® (combo) 		<ul style="list-style-type: none"> 1GB PC2-5300 CL5 NP DDR2 UDIMM 73P4984 2GB PC2-5300 CL5 NP DDR2 UDIMM 73P4985 1GB PC2-6400 NP DDR2 UDIMM 41U2977 2GB PC2-6400 NP DDR2 UDIMM 41U2978 250GB SATA 3.0Gb/s Disk (7200 rpm) 41N3015 500GB SATA 3.0Gb/s Disk (7200 rpm) 43R1990 USB Portable Diskette Drive 05K9276 USB 2.0 Lenovo Multimedia Headset 40Y8518 USB 2.0 Lenovo Webcam 40Y8519 USB 2.0 Essential Memory Key 32GB 45K1258 USB 2.0 Security Memory Key 4GB 41U5120 USB 2.0 Ultra Secure Memory Key 2GB 45J5916 USB 2.0 Ultra Secure Memory Key 4GB 45J5917 USB 2.0 Ultra Secure Memory Key 8GB 45J5918 USB 2.0 Portable 160GB Hard Disk 43R1784 USB 2.0 Portable Secure 320GB Hard Disk 43R2019 USB 2.0 Super Multi-Burner Drive 41N5565 ThinkVision® L1700p 17" Monitor 9417HE2 ThinkVision L1940p Wide 19" Monitor 4424HB6 ThinkVision L2240p Wide 22" Monitor 4422HB6 ThinkVision L2440p Wide 24" Monitor 4420HB2 ThinkCentre Ultra Small Under Desk Mount 40Y8625 Wireless Kbd & Opt Wheel Mouse (via USB) 73P4067 USB Travel Keyboard with UltraNav™ 31P9490 Laser Tilt Wheel Mouse (USB, PS/2) 41U3074 Kensington Cable Lock from Lenovo 73P2582 Acc Guide in pdf lenovo.com/accessoriesguide Other accessories at lenovo.com/accessories 		<p>Limited Warranty¹</p> <ul style="list-style-type: none"> ⇒ 3-year parts and labor ⇒ International Warranty Service⁹ ⇒ Customer Replaceable Unit (CRU) parts only (with limited onsite service for selected parts³, 8 am - 5 pm, Mon - Fri coverage excluding holidays, next business day response time) ⇒ Onsite service upgrade options (in eligible locations)⁷ <ul style="list-style-type: none"> • 3-year LOR 9x5, 4 hour response (ThinkPlus™ part number 41C9192) • 3-year LOR 24x7, 4 hour response (ThinkPlus part number 41C9193) • 4-year LOR 9x5, Next Business Day (ThinkPlus part number 41C9194) • 4-year LOR 9x5, 4 hour response (ThinkPlus part number 41C9195) • 4-year LOR 24x7, 4 hour response (ThinkPlus part number 41C9196) ⇒ ThinkPlus services at lenovo.com/thinkplus/warranty ⇒ Post warranty maintenance services available ⇒ 24 hour x 7 day¹⁴ toll-free support during the warranty period¹ via 800-426-7378 	

See footnotes for important warranty information
US models announced January 22, 2008

ThinkCentre® M57p Small (9967) - TopSeller

Personal Systems Reference (PSREF)

Name	Type-model	Slot x bay	Processor	GHz	L2 cache	Memory ⁸	SATA disk	SATA optical	Graphics	eSATA port	Intel vPro	Preload	Limited warranty ¹	Global Educ	Avail date
M57p	9967-A1U	2x3	Core 2 Duo E8400	3.00	6MB	1GB	160GB ²	DVD	GMA	eSATA	vPro	XP Pro	3-yr	None	Jun 08
M57p	9967-A2U	2x3	Core 2 Duo E8400	3.00	6MB	2GB	160GB	DVD±RW	GMA	eSATA	vPro	XP Pro	3-yr	None	Jun 08
M57p	9967-A3U	2x3	Core 2 Quad Q9300	2.50	6MB	2GB	160GB	DVD±RW	GMA	eSATA	vPro	XP Pro	3-yr	None	Jun 08
M57p	9967-A4U	2x3	Core 2 Duo E8400	3.00	6MB	1GB	160GB	DVD	GMA	eSATA	vPro	Bus32	3-yr	None	Sep 08
M57p	9967-A5U	2x3	Core 2 Duo E8400	3.00	6MB	2GB	160GB	DVD±RW	GMA	eSATA	vPro	Bus32	3-yr	None	Sep 08

• Intel Core 2 Processor with vPro™ Technology (includes Intel Active Management Technology)
• These small and medium business (SMB) models are part of the US TopSeller™ Program
• These models have a 3-year limited warranty¹

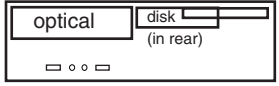
Positioning Processor	<p><i>Ultimate stability and manageability for small/medium businesses</i></p> <p>Intel® Core™ 2 Duo Processor E8400 with dual-core, Intel 64 Technology, Virtualization Technology, Execute Disable Bit, EIST, TXT, 1333MHz system bus, and 6MB shared L2 cache or Intel Core 2 Quad Processor Q9300 with quad-core (dual-core on dual-die), Intel 64 Technology, Virtualization Technology, Execute Disable Bit, EIST, TXT, and 1333MHz system bus with 6MB shared L2 cache</p> <p>Processor in FC-LGA8 package in LGA775 socket</p>	<p>Small</p>  <p>Bay ① 5.25", 1.6" high, access, std optical Bay ② 3.5", 1" high, no access, std disk Bay ③ 3.5", .5" high, access, open (reader/diskette)</p> <p>Slot 1: Low Profile, PCI Express x16 (35w max) Slot 2: Low Profile, 32-bit PCI 2.3 (5v)</p> <ul style="list-style-type: none"> • Business black color; metal case • 12.5" W X 13.4" D X 3.9" H • 317mm W X 341mm D X 99mm H • 16.4 lb (7.4 kg) in maximum configuration • Bays 1, 2, 3 flip up (latched and pivoting) • Toolless cover flips up and tilts backward on rear hinges • Toolless disk, optical drive removal • Toolless adapter retention • Toolless systemboard retention • Steel chassis supports 100 lb (45kg) monitor on top • System floor stand for vertical orientation 																																								
Implementation	Processor in FC-LGA8 package in LGA775 socket																																									
Memory	<p>1GB or 2GB std, 8GB max⁸, PC2-5300 667MHz DDR2, non-parity, dual-channel capable, four 240-pin DIMM sockets;</p> <p><i>Italics:</i> standard memory in two sockets; two sockets available; <i>Non-italics:</i> standard memory in one socket; 3 sockets available</p>																																									
Graphics	<p>Intel Graphics Media Accelerator 3100 (GMA 3100), integrated graphics in Q35, uses main memory (up to 256MB), one analog VGA DB-15 connector, supports dual independent display with optional ADD2 adapter</p>																																									
SATA disk	<p>160GB, SATA 3.0Gb/s 7200 rpm, vibration dampening mounts</p>																																									
SATA controller	Serial ATA, SATA 3.0Gb/s, integrated in ICH9DO, RAID 0/1 support																																									
SATA DVD	<i>Some:</i> DVD-ROM DL SATA 1.5Gb/s 16-48X Max ⁴ Drive (41N5618)																																									
SATA DVD±RW	<i>Some:</i> Super Multi-Burner DL DVD±RW SATA Drive (41N5620)																																									
SATA cables	Two SATA cables (each 1-drop to device), two SATA connectors																																									
eSATA port	One external SATA (eSATA) port																																									
EIDE controller	None																																									
Diskette drive	None																																									
Media reader	None																																									
Chipset	<p>Intel Q35 Express Chipset; I/O Controller Hub 9 Digital Office (ICH9DO) for SATA 3.0Gb/s with RAID 0/1 support, PCI Express[®] x1, ethernet (MAC), PCI 2.3, USB, LPC bus / SMSC[®] SCH5617 Super I/O for serial, parallel, diskette, hardware monitoring (temperature, voltage, fan speed)</p>																																									
Front ports	Two USB 2.0, microphone (stereo, 3.5mm), headphone (stereo, 3.5mm)																																									
Rear ports	Six USB 2.0, serial (9-pin), parallel (25-pin), ethernet (RJ-45), monitor (VGA DB-15), eSATA																																									
Internal connector	Two USB 2.0 planar conn (1 used; one open for media reader or 2 rear USB ports)																																									
Rear audio ports	Line-in (stereo, 3.5mm), line-out (stereo, 3.5mm), microphone-in (stereo, 3.5mm)																																									
Audio	High Definition (HD) Audio, Analog Devices AD1882 codec																																									
Speaker	One internal speaker for business audio																																									
Ethernet	Gigabit ethernet on planar, Intel 82566DM (PHY layer; MAC in ICH9DO), PCIe x1, Intel AMT 3.0, Wake on LAN [®] , ASF2.0																																									
Intel AMT	Intel Active Management Technology (iAMT)																																									
Modem	None																																									
Security chip	Winbond [®] WPCT200 SafeKeeper™ Trusted Platform Module, TCG 1.2-compliant	<p>Security</p> <ul style="list-style-type: none"> • Security chip (see information on left) • Security slot (in rear for attachment of optional Kensington[®] Microsaver[®] cable) - optional cable also locks the cover by deactivating the cover release buttons • Power-on password • Administrator password • Hard disk password • Boot sequence control • Boot without keyboard, mouse • Serial port I/O control • Parallel port I/O control • Individual USB port disablement • eSATA port disablement 																																								
Keyboard	Preferred Pro USB Keyboard (USB connector), 104-key, black, Lenovo logo	Supports ThinkVantage [®] technologies																																								
Mouse	Optical Wheel Mouse (USB connector), black, Lenovo logo	RoHS-compliant																																								
Power supply	280 watts with variable speed fan, autosensing, two diagnostic LEDs																																									
Preloaded operating system²⁰	<p>- <i>Some:</i> Microsoft[®] Windows[®] XP Professional with Vista[®] COA</p> <p>- <i>Some:</i> Microsoft Windows Vista Business Edition (32-bit)</p> <p>✦ <i>Vista models:</i> Vista Premium logo</p>																																									
Preloaded applications⁵ (all OSes; only some listed)	<ul style="list-style-type: none"> • Rescue and Recovery™ • Client Security Solution™ • ThinkVantage Productivity Center • ThinkVantage System Update • Norton Internet Security™ • Diskeeper[®] Home • PC-Doctor™ (diagnostics) • Microsoft Office 2007 Trial (60-day) • Multimedia Center for Think Offerings (DVD, DVD±RW) (XP) • Sonic RecordNow and Drive Letter Access (DVD±RW) • Corel[®] WinDVD[®] (DVD, DVD±RW) • Corel WinDVD Creator (DVD±RW) (XP) 	<p>Accessories</p> <table border="0"> <tr><td>1GB PC2-5300 CL5 NP DDR2 UDIMM</td><td>73P4984</td></tr> <tr><td>2GB PC2-5300 CL5 NP DDR2 UDIMM</td><td>73P4985</td></tr> <tr><td>1GB PC2-6400 NP DDR2 UDIMM</td><td>41U2977</td></tr> <tr><td>2GB PC2-6400 NP DDR2 UDIMM</td><td>41U2978</td></tr> <tr><td>250GB SATA 3.0Gb/s Disk (7200 rpm)</td><td>41N3015</td></tr> <tr><td>500GB SATA 3.0Gb/s Disk (7200 rpm)</td><td>43R1990</td></tr> <tr><td>USB 2.0 Lenovo Multimedia Headset</td><td>40Y8518</td></tr> <tr><td>USB 2.0 Lenovo Webcam</td><td>40Y8519</td></tr> <tr><td>USB 2.0 Essential Memory Key 32GB</td><td>45K1258</td></tr> <tr><td>USB 2.0 Ultra Secure Memory Key 8GB</td><td>45J5918</td></tr> <tr><td>USB 2.0 Portable Secure 320GB Hard Disk</td><td>43R2019</td></tr> <tr><td>ThinkVision[®] L1940p Wide 19" Monitor</td><td>4424HB6</td></tr> <tr><td>ThinkVision L2240p Wide 22" Monitor</td><td>4422HB6</td></tr> <tr><td>ThinkVision L2440p Wide 24" Monitor</td><td>4420HB2</td></tr> <tr><td>Wireless Kbd & Opt Wheel Mouse (via USB)</td><td>73P4067</td></tr> <tr><td>Laser Tilt Wheel Mouse (USB, PS/2)</td><td>41U3074</td></tr> <tr><td>Kensington Cable Lock from Lenovo</td><td>73P2582</td></tr> <tr><td>ADD2 DVI-D Monitor Connection (HDCP)</td><td>43R1985</td></tr> <tr><td>ATI™ Radeon™ HD 2400 Pro 128MB</td><td>43R1961</td></tr> <tr><td>ATI Radeon HD 2400 XT 256MB</td><td>43R1962</td></tr> </table> <p>Acc Guide in pdf lenovo.com/accessoriesguide Other accessories at lenovo.com/accessories</p>	1GB PC2-5300 CL5 NP DDR2 UDIMM	73P4984	2GB PC2-5300 CL5 NP DDR2 UDIMM	73P4985	1GB PC2-6400 NP DDR2 UDIMM	41U2977	2GB PC2-6400 NP DDR2 UDIMM	41U2978	250GB SATA 3.0Gb/s Disk (7200 rpm)	41N3015	500GB SATA 3.0Gb/s Disk (7200 rpm)	43R1990	USB 2.0 Lenovo Multimedia Headset	40Y8518	USB 2.0 Lenovo Webcam	40Y8519	USB 2.0 Essential Memory Key 32GB	45K1258	USB 2.0 Ultra Secure Memory Key 8GB	45J5918	USB 2.0 Portable Secure 320GB Hard Disk	43R2019	ThinkVision [®] L1940p Wide 19" Monitor	4424HB6	ThinkVision L2240p Wide 22" Monitor	4422HB6	ThinkVision L2440p Wide 24" Monitor	4420HB2	Wireless Kbd & Opt Wheel Mouse (via USB)	73P4067	Laser Tilt Wheel Mouse (USB, PS/2)	41U3074	Kensington Cable Lock from Lenovo	73P2582	ADD2 DVI-D Monitor Connection (HDCP)	43R1985	ATI™ Radeon™ HD 2400 Pro 128MB	43R1961	ATI Radeon HD 2400 XT 256MB	43R1962
1GB PC2-5300 CL5 NP DDR2 UDIMM	73P4984																																									
2GB PC2-5300 CL5 NP DDR2 UDIMM	73P4985																																									
1GB PC2-6400 NP DDR2 UDIMM	41U2977																																									
2GB PC2-6400 NP DDR2 UDIMM	41U2978																																									
250GB SATA 3.0Gb/s Disk (7200 rpm)	41N3015																																									
500GB SATA 3.0Gb/s Disk (7200 rpm)	43R1990																																									
USB 2.0 Lenovo Multimedia Headset	40Y8518																																									
USB 2.0 Lenovo Webcam	40Y8519																																									
USB 2.0 Essential Memory Key 32GB	45K1258																																									
USB 2.0 Ultra Secure Memory Key 8GB	45J5918																																									
USB 2.0 Portable Secure 320GB Hard Disk	43R2019																																									
ThinkVision [®] L1940p Wide 19" Monitor	4424HB6																																									
ThinkVision L2240p Wide 22" Monitor	4422HB6																																									
ThinkVision L2440p Wide 24" Monitor	4420HB2																																									
Wireless Kbd & Opt Wheel Mouse (via USB)	73P4067																																									
Laser Tilt Wheel Mouse (USB, PS/2)	41U3074																																									
Kensington Cable Lock from Lenovo	73P2582																																									
ADD2 DVI-D Monitor Connection (HDCP)	43R1985																																									
ATI™ Radeon™ HD 2400 Pro 128MB	43R1961																																									
ATI Radeon HD 2400 XT 256MB	43R1962																																									
		<p>Limited Warranty¹</p> <ul style="list-style-type: none"> ➤ 3-year parts and labor ➤ International Warranty Service⁸ ➤ Customer Replaceable Unit (CRU) parts only (with limited onsite service for selected parts³, 8 am - 5 pm, Mon - Fri coverage excluding holidays, next business day response time) ➤ Onsite service upgrade options (in eligible locations):⁷ <ul style="list-style-type: none"> • 3-year LOR 9x5, 4 hour response (ThinkPlus™ part number 41C9192) • 3-year LOR 24x7, 4 hour response (ThinkPlus part number 41C9193) • 4-year LOR 9x5, Next Business Day (ThinkPlus part number 41C9194) • 4-year LOR 9x5, 4 hour response (ThinkPlus part number 41C9195) • 4-year LOR 24x7, 4 hour response (ThinkPlus part number 41C9196) ➤ ThinkPlus services at lenovo.com/thinkplus/warranty ➤ Post warranty maintenance services available ➤ 24 hour x 7 day¹⁴ toll-free support during the warranty period¹ via 800-426-7378 																																								

See footnotes for important warranty information

US models announced August 19, 2008; previous models on June 24, 2008

© Lenovo (APOL2-9) September 2008

ThinkCentre® M57p Small (6073)

Name	Type-model	Slot x bay	Processor	GHz	L2 cache	Memory ⁸	SATA disk	SATA optical	Graphics	eSATA port	Intel vPro	Floor stand	Preload	Vista logo	Global Educ	Avail date
ES M57p	6073-BLU	2x3	Core 2 Duo E6550	2.33	4MB	1GB	160GB ²	Combo	GMA	eSATA	vPro	Stand	XP Pro		Gbl	Dec 07
M57p	6073-ABU	2x3	Core 2 Duo E6550	2.33	4MB	1GB	80GB	DVD	GMA	eSATA	vPro	Stand	Bus32	Basic		Oct 07
M57p	6073-ATU	2x3	Core 2 Duo E6550	2.33	4MB	1GB	80GB	DVD	GMA	eSATA	vPro	Stand	Bus32	Basic	Gbl	Oct 07
M57p	6073-ADU	2x3	Core 2 Duo E6550	2.33	4MB	1GB	80GB	Combo	GMA	eSATA	vPro	Stand	Bus32	Basic	Gbl	Oct 07
M57p	6073-AKU	2x3	Core 2 Duo E6550	2.33	4MB	1GB	160GB	DVD	GMA	eSATA	vPro	Stand	Bus32	Prem		Oct 07
M57p	6073-AMU	2x3	Core 2 Duo E6550	2.33	4MB	1GB	160GB	Combo	GMA	eSATA	vPro	Stand	Bus32	Basic		Oct 07
ES M57p	6073-BMU	2x3	Core 2 Duo E6550	2.33	4MB	1GB	160GB	DVD±RW	GMA	eSATA	vPro	Stand	Bus32	Basic	Gbl	Dec 07
M57p	6073-ASU	2x3	Core 2 Duo E6750	2.66	4MB	1GB	160GB	Combo	GMA	eSATA	vPro	Stand	Bus32	Basic		Oct 07
M57p	6073-A2U	2x3	Core 2 Duo E6750	2.66	4MB	1GB	160GB	DVD±RW	GMA	eSATA	vPro	Stand	Bus32	Basic		Oct 07

• Intel Core 2 Processor with vPro™ Technology (includes Intel Active Management Technology)

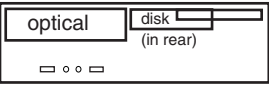
Positioning Processor	Ultimate enterprise stability and manageability for large enterprise Intel® Core™ 2 Duo Processor E6550 or E6750 with dual-core, Intel 64 Technology, Virtualization Technology, Execute Disable Bit, EIST, TXT, and 1333MHz system bus with 4MB shared L2 cache Processor in FC-LGA6 package in LGA775 socket	Small	
Implementation		Bay ① 5.25", 1.6" high, access, std optical Bay ② 3.5", 1" high, no access, std disk Bay ③ 3.5", .5" high, access, std (reader/diskette)	
Memory	1GB std, 8GB max ⁸ , PC2-5300 667MHz DDR2, non-parity, dual-channel capable, four 240-pin DIMM sockets; <i>Italics:</i> standard memory in two sockets; two sockets available; <i>Non-italics:</i> standard memory in one socket; 3 sockets available	Slot 1: Low Profile, PCI Express x16 (35w max) Slot 2: Low Profile, 32-bit PCI 2.3 (5v)	
Graphics	Intel Graphics Media Accelerator 3100 (GMA 3100), integrated graphics in Q35, uses main memory (up to 256MB), one analog VGA DB-15 connector, supports dual independent display with optional ADD2 adapter	<ul style="list-style-type: none"> • Business black color; metal case • 12.5" W X 13.4" D X 3.9" H • 317mm W X 341mm D X 99mm H • 16.4 lb (7.4 kg) in maximum configuration • Bays 1, 2, 3 flip up (latched and pivoting) • Toolless cover flips up and tilts backward on rear hinges • Toolless disk, optical drive removal • Toolless adapter retention • Toolless systemboard retention • Steel chassis supports 100 lb (45kg) monitor on top • <i>Some:</i> system floor stand for vertical orientation 	
SATA disk	80GB or 160GB, SATA 3.0Gb/s 7200 rpm, vibration dampening Serial ATA, SATA 3.0Gb/s, integrated in ICH9DO, RAID 0/1 support		
SATA DVD	<i>Some:</i> DVD-ROM DL SATA 1.5Gb/s 16-48X Max ⁴ Drive (41N5618)		
SATA Combo	<i>Some:</i> CD-RW/DVD-ROM Combo SATA 1.5Gb/s Drive		
SATA DVD±RW	<i>Some:</i> Super Multi-Burner DL DVD±RW SATA Drive (41N5620)		
SATA cables	Two SATA cables (each 1-drop to device), two SATA connectors		
eSATA port	One external SATA (eSATA) port		
EIDE controller	None		
Diskette drive	None		
Media reader	None		
Chipset	Intel Q35 Express Chipset; I/O Controller Hub 9 Digital Office (ICH9DO) for SATA 3.0Gb/s with RAID 0/1 support, PCI Express® x1, ethernet (MAC), PCI 2.3, USB, LPC bus / SMSC® SCH5617 Super I/O for serial, parallel, diskette, hardware monitoring (temperature, voltage, fan speed)		
Front ports	Two USB 2.0, microphone (stereo, 3.5mm), headphone (stereo, 3.5mm)		
Rear ports	Six USB 2.0, serial (9-pin), parallel (25-pin), ethernet (RJ-45), monitor (VGA DB-15), eSATA		
Internal connector	Two USB 2.0 planar conn (1 used; one open for media reader or 2 rear USB ports)		
Rear audio ports	Line-in (stereo, 3.5mm), line-out (stereo, 3.5mm), microphone-in (stereo, 3.5mm)		
Audio	High Definition (HD) Audio, Analog Devices AD1882 codec		
Speaker	One internal speaker for business audio		
Ethernet	Gigabit ethernet on planar, Intel 82566DM (PHY layer; MAC in ICH9DO), PCIe x1, Intel AMT 3.0, Wake on LAN®, ASF2.0		
Intel AMT	Intel Active Management Technology (iAMT)		
Modem	None		
Security chip	Winbond® WPCT200 SafeKeeper™ Trusted Platform Module, TCG 1.2-compliant		
Keyboard	Preferred Pro USB Keyboard (USB connector), 104-key, black, Lenovo logo		
Mouse	Optical Wheel Mouse (USB connector), black, Lenovo logo		
Power supply	280 watts with variable speed fan, autosensing, two diagnostic LEDs		
Preloaded operating system ²⁰	<ul style="list-style-type: none"> - <i>Some:</i> Microsoft® Windows® XP Professional with Vista® COA - <i>Some:</i> Microsoft Windows Vista Business Edition (32-bit) 		
Preloaded applications ⁵ (all OSes; only some listed)	<ul style="list-style-type: none"> • Rescue and Recovery™ • Client Security Solution™ • ThinkVantage Productivity Center • ThinkVantage System Update • System Migration Assistant • Norton Internet Security™ • Diskeeper® Home • PC-Doctor™ (diagnostics) • Adobe® Reader • Picasa from Google • Microsoft Office 2007 Trial (60-day) • Multimedia Center for Think Offerings (combo) (XP) • Sonic RecordNow and Drive Letter Access (combo, DVD±RW) • Corel® WinDVD® (combo, DVD, DVD±RW) 		
Accessories	<ul style="list-style-type: none"> 1GB PC2-5300 CL5 NP DDR2 UDIMM 73P4984 2GB PC2-5300 CL5 NP DDR2 UDIMM 73P4985 1GB PC2-6400 NP DDR2 UDIMM 41U2977 2GB PC2-6400 NP DDR2 UDIMM 41U2978 250GB SATA 3.0Gb/s Disk (7200 rpm) 41N3015 500GB SATA 3.0Gb/s Disk (7200 rpm) 43R1990 USB 2.0 Lenovo Multimedia Headset 40Y8518 USB 2.0 Lenovo Webcam 40Y8519 USB 2.0 Essential Memory Key 32GB 45K1258 USB 2.0 Ultra Secure Memory Key 8GB 45J5918 USB 2.0 Portable 160GB Hard Disk 43R1784 USB 2.0 Portable Secure 320GB Hard Disk 43R2019 ThinkVision® L1940p Wide 19" Monitor 4424HB6 ThinkVision L2240p Wide 22" Monitor 4422HB6 ThinkVision L2440p Wide 24" Monitor 4420HB2 Wireless Kbd & Opt Wheel Mouse (via USB) 73P4067 Kensington Cable Lock from Lenovo 73P2582 ADD2 DVI-D Monitor Connection (HDCP) 43R1985 ATI™ Radeon™ HD 2400 Pro 128MB 43R1961 ATI Radeon HD 2400 XT 256MB 43R1962 Acc Guide in pdf lenovo.com/accessoriesguide Other accessories at lenovo.com/accessories 		
Security	<ul style="list-style-type: none"> • Security chip (see information on left) • Security slot (in rear for attachment of optional Kensington® Microsaver® cable) - optional cable also locks the cover by deactivating the cover release buttons • Power-on password • Administrator password • Hard disk password • Boot sequence control • Boot without keyboard, mouse • Serial port I/O control • Parallel port I/O control • Individual USB port disablement • eSATA port disablement 		
Supports ThinkVantage® technologies			
RoHS-compliant			
Limited Warranty ¹	<ul style="list-style-type: none"> ↔ 3-year parts and labor ↔ International Warranty Service⁹ ↔ Customer Replaceable Unit (CRU) parts only (with limited onsite service for selected parts³, 8 am - 5 pm, Mon - Fri coverage excluding holidays, next business day response time) ↔ Onsite service upgrade options (in eligible locations):⁷ <ul style="list-style-type: none"> • 3-year LOR 9x5, 4 hour response (ThinkPlus™ part number 41C9192) • 3-year LOR 24x7, 4 hour response (ThinkPlus part number 41C9193) • 4-year LOR 9x5, Next Business Day (ThinkPlus part number 41C9194) • 4-year LOR 9x5, 4 hour response (ThinkPlus part number 41C9195) • 4-year LOR 24x7, 4 hour response (ThinkPlus part number 41C9196) ↔ ThinkPlus services at lenovo.com/thinkplus/warranty ↔ Post warranty maintenance services available ↔ 24 hour x 7 day¹⁴ toll-free support during the warranty period¹ via 800-426-7378 		

See footnotes for important warranty information

ES US models announced December 4, 2007; previous models on September 18, 2007

Name	Type-model	Slot x bay	Processor	GHz	L2 cache	Memory ⁶	SATA disk	SATA optical	Graphics	eSATA port	Intel vPro	Key-board	Preload	Global Educ	Avail date
M57p	6073-B3U	2x3	Core 2 Duo E8200	2.66	6MB	1GB	160GB ²	Combo	GMA	eSATA	vPro	Pref	XP Pro		Feb 08
M57p	6073-D3U	2x3	Core 2 Duo E8400	3.00	6MB	1GB	160GB	DVD	GMA	eSATA	vPro	Pref	XP Pro		Sep 08
M57p	6073-D2U	2x3	Core 2 Duo E8400	3.00	6MB	2GB	160GB	DVD±RW	GMA+ADD2	eSATA	vPro	Pref	XP Pro		Sep 08
M57p	6073-D4U	2x3	Core 2 Duo E8400	3.00	6MB	2GB	250GB	DVD±RW	GMA	eSATA	vPro	Pref	XP Pro		Sep 08
M57p	6073-D6U	2x3	Core 2 Duo E8400	3.00	6MB	2GB	250GB	DVD±RW	GMA+ADD2	eSATA	vPro	Finger	XP Pro		Sep 08
M57p	6073-D5U	2x3	Core 2 Quad Q9300	2.50	6MB	2GB	250GB	DVD±RW	GMA+ADD2	eSATA	vPro	Pref	XP Pro		Sep 08
M57p	6073-B2U	2x3	Core 2 Duo E8200	2.66	6MB	1GB	160GB	Combo	GMA	eSATA	vPro	Pref	Bus32		Feb 08
M57p	6073-BUJ	2x3	Core 2 Duo E8200	2.66	6MB	1GB	160GB	Combo	GMA	eSATA	vPro	Pref	Bus32	Educ	Apr 08

- Intel Core 2 Processor with vPro™ Technology (includes Intel Active Management Technology)
- These models have a 3-year limited warranty¹

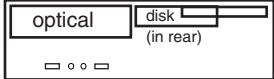
Positioning Processor	Ultimate enterprise stability and manageability for large enterprise Intel® Core™ 2 Duo Processor E8200 or E8400 with dual-core, Intel 64 Technology, Virtualization Technology, Execute Disable Bit, EIST, TXT, 1333MHz system bus, and 6MB shared L2 cache or Intel Core 2 Quad Processor Q9300 with quad-core (dual-core on dual-die), Intel 64 Technology, Virtualization Technology, Execute Disable Bit, EIST, TXT, and 1333MHz system bus with 6MB shared L2 cache Processor in FC-LGA8 package in LGA775 socket	Small	
Implementation		Bay ① 5.25", 1.6" high, access, std optical Bay ② 3.5", 1" high, no access, std disk Bay ③ 3.5", .5" high, access, open (reader/diskette)	
Memory	1GB or 2GB std, 8GB max ⁸ , PC2-5300 667MHz DDR2, non-parity, dual-channel capable, four 240-pin DIMM sockets; <i>Italics:</i> standard memory in two sockets; two sockets available; <i>Non-italics:</i> standard memory in one socket; 3 sockets available	Slot 1: Low Profile, PCI Express x16 (35w max)* Slot 2: Low Profile, 32-bit PCI 2.3 (5v)	
Graphics	All: Intel Graphics Media Accelerator 3100 (GMA 3100), integrated graphics in Q35, uses main memory (up to 256MB), one analog VGA DB-15 connector Some: ADD2 DVI-D Monitor Connection (HDCP), PCI Express® adapter in PCIe x16 slot, provides DVI-D connector to support second monitor, HDCP-compliant	* used in some models	• Business black color; metal case • 12.5" W X 13.4" D X 3.9" H • 317mm W X 341mm D X 99mm H • 16.4 lb (7.4 kg) in maximum configuration • Bays 1, 2, 3 flip up (latched and pivoting) • Toolless cover flips up and tilts backward on rear hinges • Toolless disk, optical drive removal • Toolless adapter retention • Toolless systemboard retention • Steel chassis supports 100 lb (45kg) monitor on top • System floor stand for vertical orientation
SATA disk	160GB or 250GB, SATA 3.0Gb/s 7200 rpm, vibration dampening		
SATA controller	Serial ATA, SATA 3.0Gb/s, integrated in ICH9DO, RAID 0/1 support		
SATA DVD	Some: DVD-ROM DL SATA 1.5Gb/s 16-48X Max ⁴ Drive (41N5618)		
SATA Combo	Some: CD-RW/DVD-ROM Combo SATA 1.5Gb/s Drive		
SATA DVD±RW	Some: Super Multi-Burner DL DVD±RW SATA 1.5Gb/s Drive (41N5620)		
SATA cables	Two SATA cables (each 1-drop to device), two SATA connectors		
eSATA port	One external SATA (eSATA) port		
EIDE controller	None		
Diskette drive	None		
Media reader	None		
Chipset	Intel Q35 Express Chipset; I/O Controller Hub 9 Digital Office (ICH9DO) for SATA 3.0Gb/s with RAID 0/1 support, PCI Express x1, ethernet (MAC), PCI 2.3, USB, LPC bus / SMSC® SCH5617 Super I/O for serial, parallel, diskette, hardware monitoring (temperature, voltage, fan speed)		
Front ports	Two USB 2.0, microphone (stereo, 3.5mm), headphone (stereo, 3.5mm)		
Rear ports	Six USB 2.0, serial (9-pin), parallel (25-pin), ethernet (RJ-45), monitor (VGA DB-15, DVI-D in some models), eSATA		
Internal connector	Two USB 2.0 planar conn (1 used; one open for media reader or 2 rear USB ports)		
Rear audio ports	Line-in (stereo, 3.5mm), line-out (stereo, 3.5mm), microphone-in (stereo, 3.5mm)		
Audio	High Definition (HD) Audio, Analog Devices AD1882 codec		
Speaker	One internal speaker for business audio		
Ethernet	Gigabit ethernet on planar, Intel 82566DM (PHY layer; MAC in ICH9DO), PCIe x1, Intel AMT 3.0, Wake on LAN®, ASF2.0		
Intel AMT	Intel Active Management Technology (iAMT)		
Modem	None		
Security chip	Winbond® WPCT200 SafeKeeper™ Trusted Platform Module, TCG 1.2-compliant		
Keyboard	[Finger] Lenovo USB Fingerprint Keyboard (USB connector), black (one of following)		
Mouse	[Pref] Preferred Pro USB Keyboard (USB connector), 104-key, black		
Power supply	Optical Wheel Mouse (USB connector), black, Lenovo logo 280 watts with variable speed fan, autosensing, two diagnostic LEDs		

Security

- Security chip (see information on left)
- Security slot (in rear for attachment of optional Kensington® Microsaver® cable) - optional cable also locks the cover by deactivating the cover release buttons
- Power-on password
- Administrator password
- Hard disk password
- Boot sequence control
- Boot without keyboard, mouse
- Serial port I/O control
- Parallel port I/O control
- Individual USB port disablement
- eSATA port disablement

Supports ThinkVantage® technologies

RoHS-compliant

Limited Warranty¹

- ↪ 3-year parts and labor
- ↪ International Warranty Service⁹
- ↪ Customer Replaceable Unit (CRU) parts only (with limited onsite service for selected parts³, 8 am - 5 pm, Mon - Fri coverage excluding holidays, next business day response time)
- ↪ Onsite service upgrade options (in eligible locations):⁷
 - 3-year LOR 9x5, 4 hour response (ThinkPlus™ part number 41C9192)
 - 3-year LOR 24x7, 4 hour response (ThinkPlus part number 41C9193)
 - 4-year LOR 9x5, Next Business Day (ThinkPlus part number 41C9194)
 - 4-year LOR 9x5, 4 hour response (ThinkPlus part number 41C9195)
 - 4-year LOR 24x7, 4 hour response (ThinkPlus part number 41C9196)
- ↪ ThinkPlus services at lenovo.com/thinkplus/warranty
- ↪ 24 hour x 7 day¹⁴ toll-free support during the warranty period¹ via 800-426-7378

Preloaded operating system ²⁰	Accessories	
- Some: Microsoft® Windows® XP Professional with Vista® COA	1GB PC2-5300 CL5 NP DDR2 UDIMM	73P4984
- Some: Microsoft Windows Vista Business Edition (32-bit)	2GB PC2-5300 CL5 NP DDR2 UDIMM	73P4985
✦ Vista models: Vista Basic logo	1GB PC2-6400 NP DDR2 UDIMM	41U2977
	2GB PC2-6400 NP DDR2 UDIMM	41U2978
	500GB SATA 3.0Gb/s Disk (7200 rpm)	43R1990
	USB 2.0 Lenovo Multimedia Headset	40Y8518
	USB 2.0 Lenovo Webcam	40Y8519
	USB 2.0 Ultra Secure Memory Key 8GB	45J5918
	USB 2.0 Portable Secure 320GB Hard Disk	43R2019
	ThinkVision® L2440p Wide 24" Monitor	4420HB2
	Wireless Kbd & Opt Wheel Mouse (via USB)	73P4067
	Kensington Cable Lock from Lenovo	73P2582
	ADD2 DVI-D Monitor Connection (HDCP)	43R1985
	ATI™ Radeon™ HD 2400 Pro 128MB	43R1961
	ATI Radeon HD 2400 XT 256MB	43R1962
	Other accessories at lenovo.com/accessories	
Preloaded applications⁵ (all OSes; only some listed)		
• Some: Education software (Vista)		
- VitalSource Library College Edition		
- Adobe® Instructor Resource Center		
- Adobe Digital School Collection		
- Photoshop Elements 6 (and CD)		
- Premier Elements 4 (and DVD)		
- Acrobat 8 Professional (and CD)		
- Contribute 4 (and CD)		
• Rescue and Recovery™		

See footnotes for important warranty information

¹⁴ US models announced August 19, 2008; previous models on January 22 or March 25, 2008

Name	Type-model	Slot x bay	Processor	GHz	L2 cache	Memory ^a	SATA disk	SATA optical	Graphics	eSATA port	ENERGY STAR 4.0	Intel vPro	Vista preload	Vista logo	Global Educ	Avail date
M57p	9196-A1U	2x3	Core 2 Duo E6550	2.33	4MB	1GB	160GB ²	Combo	GMA	eSATA	ES40	vPro	Bus32	Basic	None	Nov 07

- Intel Core 2 Processor with vPro™ Technology (includes Intel Active Management Technology)
- This model has a 3-year limited warranty¹

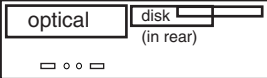
Positioning Processor	Ultimate enterprise stability and manageability for large enterprise Intel® Core™ 2 Duo Processor E6550 with dual-core, Intel 64 Technology, Virtualization Technology, Execute Disable Bit, EIST, TXT, and 1333MHz system bus with 4MB shared L2 cache Processor in FC-LGA6 package in LGA775 socket										Small					
Implementation	1GB std, 8GB max ^a , PC2-5300 667MHz DDR2, non-parity, dual-channel capable, four 240-pin DIMM sockets; Non-italics: standard memory in one socket; 3 sockets available										Bay ① 5.25", 1.6" high, access, std optical	<ul style="list-style-type: none"> • Business black color; metal case • 12.5" W X 13.4" D X 3.9" H • 317mm W X 341mm D X 99mm H • 16.4 lb (7.4 kg) in maximum configuration • Bays 1, 2, 3 flip up (latched and pivoting) • Toolless cover flips up and tilts backward on rear hinges • Toolless disk, optical drive removal • Toolless adapter retention • Toolless systemboard retention • Steel chassis supports 100 lb (45kg) monitor on top • System floor stand for vertical orientation 				
Memory	Intel Graphics Media Accelerator 3100 (GMA 3100), integrated graphics in Q35, uses main memory (up to 256MB), one analog VGA DB-15 connector, supports dual independent display with optional ADD2 adapter										Bay ② 3.5", 1" high, no access, std disk					
Graphics	160GB, SATA 3.0Gb/s 7200 rpm, vibration dampening mounts Serial ATA, SATA 3.0Gb/s, integrated in ICH9DO, RAID 0/1 support CD-RW/DVD-ROM Combo SATA 1.5Gb/s Drive Two SATA cables (each 1-drop to device), two SATA connectors One external SATA (eSATA) port										Bay ③ 3.5", .5" high, access, open (reader/diskette)					
SATA disk	None															
SATA controller	None															
SATA Combo	None															
SATA cables	None															
eSATA port	None															
EIDE controller	None															
Diskette drive	None															
Media reader	None															
Chipset	Intel Q35 Express Chipset; I/O Controller Hub 9 Digital Office (ICH9DO) for SATA 3.0Gb/s with RAID 0/1 support, PCI Express® x1, ethernet (MAC), PCI 2.3, USB, LPC bus / SMSC® SCH5617 Super I/O for serial, parallel, diskette, hardware monitoring (temperature, voltage, fan speed)										Security <ul style="list-style-type: none"> • Security chip (see information on left) • Security slot (in rear for attachment of optional Kensington® Microsaver® cable) - optional cable also locks the cover by deactivating the cover release buttons • Power-on password • Administrator password • Hard disk password • Boot sequence control • Boot without keyboard, mouse • Serial port I/O control • Parallel port I/O control • Individual USB port disablement • eSATA port disablement 					
Front ports	Two USB 2.0, microphone (stereo, 3.5mm), headphone (stereo, 3.5mm)										Supports ThinkVantage® technologies					
Rear ports	Six USB 2.0, serial (9-pin), parallel (25-pin), ethernet (RJ-45), monitor (VGA DB-15), eSATA										EPEAT™ Gold rating					
Internal connector	Two USB 2.0 planar conn (1 used; one open for media reader or 2 rear USB ports)										ENERGY STAR 4.0-compliant					
Rear audio ports	Line-in (stereo, 3.5mm), line-out (stereo, 3.5mm), microphone-in (stereo, 3.5mm)										RoHS-compliant					
Audio	High Definition (HD) Audio, Analog Devices AD1882 codec										Limited Warranty¹ <ul style="list-style-type: none"> ↔ 3-year parts and labor ↔ International Warranty Service⁹ ↔ Customer Replaceable Unit (CRU) parts only (with limited onsite service for selected parts³, 8 am - 5 pm, Mon - Fri coverage excluding holidays, next business day response time) ↔ Onsite service upgrade options (in eligible locations):⁷ <ul style="list-style-type: none"> • 3-year LOR 9x5, 4 hour response (ThinkPlus™ part number 41C9192) • 3-year LOR 24x7, 4 hour response (ThinkPlus part number 41C9193) • 4-year LOR 9x5, Next Business Day (ThinkPlus part number 41C9194) • 4-year LOR 9x5, 4 hour response (ThinkPlus part number 41C9195) • 4-year LOR 24x7, 4 hour response (ThinkPlus part number 41C9196) ↔ ThinkPlus services at lenovo.com/thinkplus/warranty ↔ Post warranty maintenance services available ↔ 24 hour x 7 day¹⁴ toll-free support during the warranty period¹ via 800-426-7378 					
Speaker	One internal speaker for business audio															
Ethernet	Gigabit ethernet on planar, Intel 82566DM (PHY layer; MAC in ICH9DO), PCIe x1, Intel AMT 3.0, Wake on LAN®, ASF2.0															
Intel AMT	Intel Active Management Technology (iAMT)															
Modem	None															
Security chip	Winbond® WPCT200 SafeKeeper™ Trusted Platform Module, TCG 1.2-compliant															
Keyboard	Preferred Pro USB Keyboard (USB connector), 104-key, black, Lenovo logo															
Mouse	Optical Wheel Mouse (USB connector), black, Lenovo logo															
Power supply	280 watts with variable speed fan, autosensing, two diagnostic LEDs, 80% PSU															
Preloaded operating system²⁰	Accessories															
- Microsoft® Windows® Vista® Business Edition (32-bit)	1GB PC2-5300 CL5 NP DDR2 UDIMM 73P4984															
	2GB PC2-5300 CL5 NP DDR2 UDIMM 73P4985															
	1GB PC2-6400 NP DDR2 UDIMM 41U2977															
	2GB PC2-6400 NP DDR2 UDIMM 41U2978															
	250GB SATA 3.0Gb/s Disk (7200 rpm) 41N3015															
	500GB SATA 3.0Gb/s Disk (7200 rpm) 43R1990															
	USB Portable Diskette Drive 05K9276															
	USB 2.0 Lenovo Multimedia Headset 40Y8518															
	USB 2.0 Lenovo Webcam 40Y8519															
	USB 2.0 Essential Memory Key 32GB 45K1258															
	USB 2.0 Ultra Secure Memory Key 4GB 45J5917															
	USB 2.0 Ultra Secure Memory Key 8GB 45J5918															
	USB 2.0 Portable 160GB Hard Disk 43R1784															
	USB 2.0 Portable Secure 320GB Hard Disk 43R2019															
	USB 2.0 Super Multi-Burner Drive 41N5565															
	Super Multi-Burner DL DVD±RW SATA Drive 41N5620															
	ThinkVision® L1700p 17" Monitor 9417HE2															
	ThinkVision L1940p Wide 19" Monitor 4424HB6															
	ThinkVision L2240p Wide 22" Monitor 4422HB6															
	ThinkVision L2440p Wide 24" Monitor 4420HB2															
	Wireless Kbd & Opt Wheel Mouse (via USB) 73P4067															
	Laser Tilt Wheel Mouse (USB, PS/2) 41U3074															
	Kensington Cable Lock from Lenovo 73P2582															
	ADD2 DVI-D Monitor Connection (HDCP) 43R1985															
	ATI™ Radeon™ HD 2400 Pro 128MB 43R1961															
	ATI Radeon HD 2400 XT 256MB 43R1962															
	Acc Guide in pdf lenovo.com/accessoriesguide															
	Other accessories at lenovo.com/accessories															

See footnotes for important warranty information
US model announced September 18, 2007

ThinkCentre® M57p Tower (9979) - TopSeller

Personal Systems Reference (PSREF)

Name	Type-model	Slot x bay	Processor	GHz	L2 cache	Memory ⁸	SATA disk	SATA optical	Graphics	eSATA port	Intel vPro	Preload	Vista logo	Global Educ	Avail date
M57p	9979-A1U	4x5	Core 2 Duo E8400	3.00	6MB	2GB	160GB ²	DVD±RW	GMA	None	vPro	XP Pro		None	Jun 08
M57p	9979-A2U	4x5	Core 2 Quad Q9300	2.50	6MB	2GB	160GB	DVD±RW	GMA	None	vPro	XP Pro		None	Jun 08
M57p	9979-A3U	4x5	Core 2 Duo E8400	3.00	6MB	2GB	160GB	DVD±RW	GMA	None	vPro	Bus32	Premium	None	Sep 08

- **Intel Core 2 Processor with vPro™ Technology (includes Intel Active Management Technology)**
- **These small and medium business (SMB) models are part of the US TopSeller™ Program**
- **These models have a 3-year limited warranty¹**

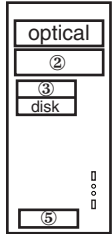
Positioning Processor	<i>Ultimate stability and manageability for small/medium businesses</i> Intel® Core™ 2 Duo Processor E8400 with dual-core , Intel 64 Technology, Virtualization Technology, Execute Disable Bit, EIST, TXT, 1333MHz system bus, and 6MB shared L2 cache or Intel Core 2 Quad Processor Q9300 with quad-core (dual-core on dual-die), Intel 64 Technology, Virtualization Technology, Execute Disable Bit, EIST, TXT, and 1333MHz system bus with 6MB shared L2 cache Processor in FC-LGA8 package in LGA775 socket	Tower <ul style="list-style-type: none"> • Business black color; metal case • 6.9" W X 17.0" D X 15.7" H • 175mm W X 432mm D X 400mm H • 22.5 lb (10.2 kg) in max configuration • Handle on top front • Toolless cover removal • Toolless disk, diskette drive, optical drive removal • Toolless adapter retention 
Implementation		
Memory	2GB std , 8GB max ⁸ , PC2-5300 667MHz DDR2 , non-parity, dual-channel capable, four 240-pin DIMM sockets; <i>Italics:</i> standard memory in two sockets; two sockets available	Bay ① 5.25", 1.6" high, access, std optical Bay ② 5.25", 1.6" high, access, open Bay ③ 3.5", 1" high, access, open (reader/diskette) Bay ④ 3.5", 1" high, no access, std disk Bay ⑤ 3.5", 1" high, no access, opt disk
Graphics	Intel Graphics Media Accelerator 3100 (GMA 3100) , integrated graphics in Q35, uses main memory (up to 256MB), one analog VGA DB-15 connector, supports dual independent display with optional ADD2 adapter	Slot 1: half-length, full-height, PCI Express x16 (75w max) Slot 2: half-length, full-height, PCI Express x1 Slot 3: half-length, full-height, 32-bit PCI 2.3 (5v) Slot 4: half-length, full-height, 32-bit PCI 2.3 (5v)
SATA disk SATA controller SATA DVD±RW SATA cables	160GB , SATA 3.0Gb/s 7200 rpm, vibration dampening mounts Serial ATA, SATA 3.0Gb/s, integrated in ICH9DO, RAID 0/1 support Super Multi-Burner DL DVD±RW SATA 1.5Gb/s Drive (41N5620) Two SATA cables (each 1-drop to device), three SATA connectors and one eSATA/SATA connector on planar	
eSATA port EIDE controller Diskette drive Media reader	None None None None	
Chipset	Intel Q35 Express Chipset ; I/O Controller Hub 9 Digital Office (ICH9DO) for SATA 3.0Gb/s with RAID 0/1 support, PCI Express [®] x1, ethernet (MAC), PCI 2.3, USB, LPC bus / SMSC® SCH5617 Super I/O for serial, parallel, diskette, hardware monitoring (temperature, voltage, fan speed)	
Front ports Rear ports	Two USB 2.0, microphone (stereo, 3.5mm), headphone (stereo, 3.5mm) Six USB 2.0, serial (9-pin), parallel (25-pin), keyboard (PS/2), mouse (PS/2), ethernet (RJ-45), monitor (VGA DB-15)	
Internal connector Rear audio ports Audio Speaker Ethernet	Two USB 2.0 planar conn (1 used; one open for media reader or 2 rear USB ports) Line-in (stereo, 3.5mm), line-out (stereo, 3.5mm), microphone-in (stereo, 3.5mm) High Definition (HD) Audio, Analog Devices AD1882 codec One internal speaker for business audio Gigabit ethernet on planar, Intel 82566DM (PHY layer; MAC in ICH9DO), PCIe x1, Intel AMT 3.0, Wake on LAN [®] , ASF2.0	
Intel AMT Modem Security chip	Intel Active Management Technology (iAMT) None Winbond® WPCT200 SafeKeeper™ Trusted Platform Module, TCG 1.2-compliant	Security <ul style="list-style-type: none"> • Security chip (see information on left) • One lock to secure both cover and entire system to fixed object: <ul style="list-style-type: none"> - Padlock loop (in rear for opt padlock) - Security slot (in rear for optional Kensington® Microsaver® cable) • Power-on password • Administrator password • Hard disk password • Boot sequence control • Boot without keyboard, mouse, diskette • Serial port I/O control • Parallel port I/O control • Individual USB port disablement
Keyboard Mouse Power supply	Preferred Pro USB Keyboard (USB connector), 104-key, black, Lenovo logo Optical Wheel Mouse (USB connector), black, Lenovo logo 280 watts with variable speed fan, manual switch, two diagnostic LEDs	Supports ThinkVantage® technologies RoHS-compliant

Preloaded operating system ²⁰	Accessories	
- <i>Some:</i> Microsoft® Windows® XP Professional with Vista® COA	1GB PC2-5300 CL5 NP DDR2 UDIMM	73P4984
- <i>Some:</i> Microsoft Windows Vista Business Edition (32-bit)	2GB PC2-5300 CL5 NP DDR2 UDIMM	73P4985
	1GB PC2-6400 NP DDR2 UDIMM	41U2977
	2GB PC2-6400 NP DDR2 UDIMM	41U2978
	500GB SATA 3.0Gb/s Disk (7200 rpm)	43R1990
	USB 2.0 Lenovo Multimedia Headset	40Y8518
	USB 2.0 Lenovo Webcam	40Y8519
	USB 2.0 Essential Memory Key 32GB	45K1258
	USB 2.0 Ultra Secure Memory Key 8GB	45J5918
	USB 2.0 Portable Secure 320GB Hard Disk	43R2019
	ThinkVision® L2240p Wide 22" Monitor	4422HB6
	ThinkVision L2440p Wide 24" Monitor	4420HB2
	Wireless Kbd & Opt Wheel Mouse (via USB)	73P4067
	Laser Tilt Wheel Mouse (USB, PS/2)	41U3074
	Kensington Cable Lock from Lenovo	73P2582
	ADD2 DVI-D Monitor Connection (HDCP)	43R1985
	ATI™ Radeon™ HD 2400 Pro 128MB	43R1961
	ATI Radeon HD 2400 XT 256MB	43R1962
	ATI Radeon HD 2600 XT 512MB	43R1963
	NVIDIA® Quadro® 256MB NVS 290	43R1765
	NVIDIA Quadro 256MB FX 370	43R1766
	NVIDIA Quadro 512MB FX 1700	43R1767
	Acc Guide in pdf lenovo.com/accessoriesguide	
	Other accessories at lenovo.com/accessories	

- ↪ **3-year parts and labor**
- ↪ **International Warranty Service⁹**
- ↪ **Customer Replaceable Unit (CRU) parts only (with limited onsite service for selected parts³, 8 am - 5 pm, Mon - Fri coverage excluding holidays, next business day response time)**
- ↪ **Onsite service upgrade options (in eligible locations):⁷**
 - **3-year LOR 9x5, 4 hour response** (ThinkPlus™ part number 41C9192)
 - **3-year LOR 24x7, 4 hour response** (ThinkPlus part number 41C9193)
 - **4-year LOR 9x5, Next Business Day** (ThinkPlus part number 41C9194)
 - **4-year LOR 9x5, 4 hour response** (ThinkPlus part number 41C9195)
 - **4-year LOR 24x7, 4 hour response** (ThinkPlus part number 41C9196)
- ↪ **ThinkPlus services at lenovo.com/thinkplus/warranty**
- ↪ **Post warranty maintenance services available**
- ↪ **24 hour x 7 day¹⁴ toll-free support during the warranty period¹ via 800-426-7378**

See footnotes for important warranty information

¹⁴ US model announced August 19, 2008; previous models on June 24, 2008

© Lenovo (APOL2-10) September 2008

Name	Type-model	Slot x bay	Processor	GHz	L2 cache	Memory ⁸	SATA disk	SATA optical	Graphics	eSATA port	Intel vPro	Preload	Vista logo	Global Educ	Avail date
M57p	9088-BEU	4x5	Core 2 Duo E6550	2.33	4MB	1GB	160GB ²	Combo	GMA	None	vPro	XP Pro		Gbl	Dec 07
M57p	9088-BFU	4x5	Core 2 Duo E6750	2.66	4MB	1GB	160GB	Combo	GMA	None	vPro	XP Pro		Gbl	Dec 07
M57p	9088-B2U	4x5	Core 2 Quad Q6600	2.40	8MB	2GB	160GB	Combo	GMA	None	vPro	XP Pro			Dec 07
M57p	9088-ACU	4x5	Core 2 Duo E6550	2.33	4MB	1GB	80GB	DVD	GMA	None	vPro	Bus32	Basic		Oct 07
M57p	9088-ARU	4x5	Core 2 Duo E6550	2.33	4MB	1GB	80GB	DVD	GMA	None	vPro	Bus32	Basic	Gbl	Oct 07
M57p	9088-AEU	4x5	Core 2 Duo E6550	2.33	4MB	1GB	80GB	Combo	GMA	None	vPro	Bus32	Basic	Gbl	Oct 07
M57p	9088-A5U	4x5	Core 2 Duo E6550	2.33	4MB	1GB	160GB	DVD	GMA	None	vPro	Bus32	Premium		Oct 07
M57p	9088-AKU	4x5	Core 2 Duo E6550	2.33	4MB	1GB	160GB	Combo	GMA	None	vPro	Bus32	Basic		Oct 07
M57p	9088-BGU	4x5	Core 2 Duo E6550	2.33	4MB	1GB	160GB	DVD±RW	GMA	None	vPro	Bus32	Basic	Gbl	Dec 07
M57p	9088-APU	4x5	Core 2 Duo E6750	2.66	4MB	1GB	160GB	Combo	GMA	None	vPro	Bus32	Basic		Oct 07
M57p	9088-A2U	4x5	Core 2 Duo E6750	2.66	4MB	1GB	160GB	DVD±RW	GMA	None	vPro	Bus32	Basic		Oct 07
M57p	9088-B3U	4x5	Core 2 Quad Q6600	2.40	8MB	2GB	160GB	Combo	GMA	None	vPro	Bus32	Premium		Dec 07

• Intel Core 2 Processor with vPro™ Technology (includes Intel Active Management Technology)

Positioning Processor	Ultimate enterprise stability and manageability for large enterprise Intel® Core™ 2 Duo Processor E6550 or E6750 with dual-core, Intel 64 Technology, Virtualization Technology, Execute Disable Bit, EIST, TXT, and 1333MHz system bus with 4MB shared L2 cache or Intel Core 2 Quad Processor Q6600 with quad-core (dual-core on dual-die), Intel 64 Technology, Virtualization Technology, Execute Disable Bit, EIST, and 1066MHz system bus with 8MB shared L2 cache Processor in FC-LGA6 package in LGA775 socket	Tower	<ul style="list-style-type: none"> Business black color; metal case 6.9" W X 17.0" D X 15.7" H 175mm W X 432mm D X 400mm H 22.5 lb (10.2 kg) in max configuration Handle on top front Toolless cover removal Toolless disk, diskette drive, optical drive removal Toolless adapter retention 	
Implementation		<ul style="list-style-type: none"> Bay ① 5.25", 1.6" high, access, std optical Bay ② 5.25", 1.6" high, access, open Bay ③ 3.5", 1" high, access, open (reader/diskette) Bay ④ 3.5", 1" high, no access, std disk Bay ⑤ 3.5", 1" high, no access, opt disk 		
Memory	1GB or 2GB std, 8GB max ⁸ , PC2-5300 667MHz DDR2, non-parity, dual-channel capable, four 240-pin DIMM sockets; <i>Italics:</i> standard memory in two sockets; two sockets available; <i>Non-italics:</i> standard memory in one socket; 3 sockets available			
Graphics	Intel Graphics Media Accelerator 3100 (GMA 3100), integrated graphics in Q35, uses main memory (up to 256MB), one analog VGA DB-15 connector, supports dual independent display with optional ADD2 adapter			
SATA disk	80GB or 160GB, SATA 3.0Gb/s 7200 rpm, vibration dampening			
SATA controller	Serial ATA, SATA 3.0Gb/s, integrated in ICH9DO, RAID 0/1 support			
SATA DVD	<i>Some:</i> DVD-ROM DL SATA 1.5Gb/s 16-48X Max ⁴ Drive (41N5618)			
SATA Combo	<i>Some:</i> CD-RW/DVD-ROM Combo SATA 1.5Gb/s Drive			
SATA DVD±RW	<i>Some:</i> Super Multi-Burner DL DVD±RW SATA 1.5Gb/s Drive (41N5620)			
SATA cables	Two SATA cables (each 1-drop to device), three SATA connectors and one eSATA/SATA connector on planar			
eSATA port	None			
EIDE controller	None			
Diskette drive	None			
Media reader	None			
Chipset	Intel Q35 Express Chipset; I/O Controller Hub 9 Digital Office (ICH9DO) for SATA 3.0Gb/s with RAID 0/1 support, PCI Express [®] x1, ethernet (MAC), PCI 2.3, USB, LPC bus / SMSC [®] SCH5617 Super I/O for serial, parallel, diskette, hardware monitoring (temperature, voltage, fan speed)			
Front ports	Two USB 2.0, microphone (stereo, 3.5mm), headphone (stereo, 3.5mm)			
Rear ports	Six USB 2.0, serial (9-pin), parallel (25-pin), keyboard (PS/2), mouse (PS/2), ethernet (RJ-45), monitor (VGA DB-15)			
Internal connector	Two USB 2.0 planar conn (1 used; one open for media reader or 2 rear USB ports)			
Rear audio ports	Line-in (stereo, 3.5mm), line-out (stereo, 3.5mm), microphone-in (stereo, 3.5mm)			
Audio	High Definition (HD) Audio, Analog Devices AD1882 codec			
Speaker	One internal speaker for business audio			
Ethernet	Gigabit ethernet on planar, Intel 82566DM (PHY layer; MAC in ICH9DO), PCIe x1, Intel AMT 3.0, Wake on LAN [®] , ASF2.0			
Intel AMT	Intel Active Management Technology (iAMT)			
Modem	None			
Security chip	Winbond [®] WPCT200 SafeKeeper™ Trusted Platform Module, TCG 1.2-compliant			
Keyboard	Preferred Pro USB Keyboard (USB connector), 104-key, black, Lenovo logo			
Mouse	Optical Wheel Mouse (USB connector), black, Lenovo logo			
Power supply	280 watts with variable speed fan, manual switch, two diagnostic LEDs			
Preloaded operating system ²⁰	<ul style="list-style-type: none"> <i>Some:</i> Microsoft[®] Windows[®] XP Professional with Vista[®] COA <i>Some:</i> Microsoft Windows Vista Business Edition (32-bit) 	Accessories <ul style="list-style-type: none"> 1GB PC2-5300 CL5 NP DDR2 UDIMM 73P4984 2GB PC2-5300 CL5 NP DDR2 UDIMM 73P4985 1GB PC2-6400 NP DDR2 UDIMM 41U2977 2GB PC2-6400 NP DDR2 UDIMM 41U2978 USB 2.0 Ultra Secure Memory Key 8GB 45J5918 ThinkVision[®] L2440p Wide 24" Monitor 4420HB2 ADD2 DVI-D Monitor Connection (HDCP) 43R1985 ATI™ Radeon™ HD 2400 Pro 128MB 43R1961 ATI Radeon HD 2400 XT 256MB 43R1962 ATI Radeon HD 2600 XT 512MB 43R1963 NVIDIA[®] Quadro[®] 256MB NVS 290 43R1765 NVIDIA Quadro 256MB FX 370 43R1766 NVIDIA Quadro 512MB FX 1700 43R1767 Acc Guide in pdf lenovo.com/accessoriesguide Other accessories at lenovo.com/accessories 		
Preloaded applications ⁵ (all OSEs; only some listed)	<ul style="list-style-type: none"> Rescue and Recovery™ Client Security Solution™ ThinkVantage Productivity Center Norton Internet Security™ Microsoft Office 2007 Trial (60-day) Sonic RecordNow and Drive Letter Access (combo, DVD±RW) Corel[®] WinDVD[®] (combo, DVD, DVD±RW) 			
			Security <ul style="list-style-type: none"> Security chip (see information on left) One lock to secure both cover and entire system to fixed object: <ul style="list-style-type: none"> Padlock loop (in rear for opt padlock) Security slot (in rear for optional Kensington[®] Microsaver[®] cable) Power-on password Administrator password Hard disk password Boot sequence control Boot without keyboard, mouse, diskette Serial port I/O control Parallel port I/O control Individual USB port disablement 	
			Supports ThinkVantage [®] technologies	
			RoHS-compliant	
			Limited Warranty¹ <ul style="list-style-type: none"> 3-year parts and labor Customer Replaceable Unit (CRU) parts only (with limited onsite service for selected parts³, 8 am - 5 pm, Mon - Fri coverage excluding holidays, next business day response time) Onsite service upgrade options (in eligible locations):⁷ <ul style="list-style-type: none"> 3-year LOR 9x5, 4 hour response (ThinkPlus™ part number 41C9192) 3-year LOR 24x7, 4 hour response (ThinkPlus part number 41C9193) 4-year LOR 9x5, Next Business Day (ThinkPlus part number 41C9194) 4-year LOR 9x5, 4 hour response (ThinkPlus part number 41C9195) 4-year LOR 24x7, 4 hour response (ThinkPlus part number 41C9196) ThinkPlus services at lenovo.com/thinkplus/warranty 24 hour x 7 day¹⁴ toll-free support during the warranty period¹ via 800-426-7378 	

See footnotes for important warranty information

¹⁸ US models announced December 4, 2007; previous models on September 18, 2007

Name	Type-model	Slot x bay	Processor	GHz	L2 cache	Memory ⁸	SATA disk	SATA optical	Graphics	eSATA port	Intel vPro	Preload	Global Educ	Avail date
M57p	9088-B1U	4x5	Core 2 Duo E8200	2.66	6MB	1GB	160GB ²	Combo	GMA	None	vPro	XP Pro		Feb 08
M57p	9088-D6U	4x5	Core 2 Duo E8400	3.00	6MB	1GB	160GB	DVD	GMA	None	vPro	XP Pro		Sep 08
M57p	9088-D4U	4x5	Core 2 Duo E8400	3.00	6MB	2GB	160GB	DVD±RW	GMA+ADD2	None	vPro	XP Pro		Sep 08
M57p	9088-D5U	4x5	Core 2 Duo E8400	3.00	6MB	2GB	250GB	DVD±RW	2400XT	None	vPro	XP Pro		Sep 08
M57p	9088-D3U	4x5	Core 2 Quad Q9300	2.50	6MB	2GB	160GB	DVD±RW	GMA+ADD2	None	vPro	XP Pro		Sep 08
M57p	9088-AWU	4x5	Core 2 Duo E8200	2.66	6MB	1GB	160GB	Combo	GMA	None	vPro	Business32		Feb 08
M57p	9088-BWU	4x5	Core 2 Duo E8400	3.00	6MB	1GB	160GB	DVD±RW	GMA	None	vPro	Business32	Educ	Apr 08

- Intel Core 2 Processor with vPro™ Technology (includes Intel Active Management Technology)
- These models have a 3-year limited warranty¹

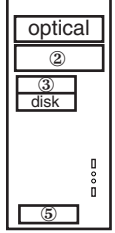
Positioning Processor	Ultimate enterprise stability and manageability for large enterprise Intel® Core™ 2 Duo Processor E8200 or E8400 with dual-core, Intel 64 Technology, Virtualization Technology, Execute Disable Bit, EIST, TXT, 1333MHz system bus, and 6MB shared L2 cache or Intel Core 2 Quad Processor Q9300 with quad-core (dual-core on dual-die), Intel 64 Technology, Virtualization Technology, Execute Disable Bit, EIST, TXT, and 1333MHz system bus with 6MB shared L2 cache Processor in FC-LGA8 package in LGA775 socket		Tower		
Implementation			<ul style="list-style-type: none"> • Business black color; metal case • 6.9" W X 17.0" D X 15.7" H • 175mm W X 432mm D X 400mm H • 22.5 lb (10.2 kg) in max configuration • Handle on top front • Toolless cover removal • Toolless disk, diskette drive, optical drive removal • Toolless adapter retention 		
Memory	1GB or 2GB std, 8GB max ⁸ , PC2-5300 667MHz DDR2, non-parity, dual-channel capable, four 240-pin DIMM sockets; <i>Italics:</i> standard memory in two sockets; two sockets available; <i>Non-italics:</i> standard memory in one socket; 3 sockets available				
Graphics	<i>Some:</i> Intel Graphics Media Accelerator 3100 (GMA 3100), integrated graphics in Q35, uses main memory (up to 256MB), one analog VGA DB-15 connector <i>Some:</i> ADD2 DVI-D Monitor Connection (HDCP), PCI Express® adapter in PCIe x16 slot, provides DVI-D connector to support second monitor, HDCP-compliant <i>Some:</i> ATI™ Radeon™ HD 2400 XT, PCI Express x16 adapter, 256MB, dual-head support, VGA and DVI-I connectors via dongle, S-Video out for TV-out, HDCP, DirectX® 10, ATI Avivo™, dual-link DVI, 35 watts		Bay ① 5.25", 1.6" high, access, std optical Bay ② 5.25", 1.6" high, access, open Bay ③ 3.5", 1" high, access, open (reader/diskette) Bay ④ 3.5", 1" high, no access, std disk Bay ⑤ 3.5", 1" high, no access, opt disk Slot 1: half-length, full-height, PCI Express x16 (75w max)* Slot 2: half-length, full-height, PCI Express x1 Slot 3: half-length, full-height, 32-bit PCI 2.3 (5v) Slot 4: half-length, full-height, 32-bit PCI 2.3 (5v) * used in some models		
SATA disk	160GB or 250GB, SATA 3.0Gb/s 7200 rpm, vibration dampening mounts		Security <ul style="list-style-type: none"> • Security chip (see information on left) • One lock to secure both cover and entire system to fixed object: <ul style="list-style-type: none"> - Padlock loop (in rear for opt padlock) - Security slot (in rear for optional Kensington® Microsaver® cable) • Power-on password • Administrator password • Hard disk password • Boot sequence control • Boot without keyboard, mouse, diskette • Serial port I/O control • Parallel port I/O control • Individual USB port disablement 		
SATA controller	Serial ATA, SATA 3.0Gb/s, integrated in ICH9DO, RAID 0/1 support				
SATA DVD	<i>Some:</i> DVD-ROM DL SATA 1.5Gb/s 16-48X Max ⁴ Drive (41N5618)				
SATA Combo	<i>Some:</i> CD-RW/DVD-ROM Combo SATA 1.5Gb/s Drive				
SATA DVD±RW	<i>Some:</i> Super Multi-Burner DL DVD±RW SATA 1.5Gb/s Drive (41N5620)		Limited Warranty¹ <ul style="list-style-type: none"> ↔ 3-year parts and labor ↔ International Warranty Service⁹ ↔ Customer Replaceable Unit (CRU) parts only (with limited onsite service for selected parts³, 8 am - 5 pm, Mon - Fri coverage excluding holidays, next business day response time) ↔ Onsite service upgrade options (in eligible locations)⁷ <ul style="list-style-type: none"> • 3-year LOR 9x5, 4 hour response (ThinkPlus™ part number 41C9192) • 3-year LOR 24x7, 4 hour response (ThinkPlus part number 41C9193) • 4-year LOR 9x5, 4 hour response (ThinkPlus part number 41C9195) • 4-year LOR 24x7, 4 hour response (ThinkPlus part number 41C9196) ↔ ThinkPlus services at lenovo.com/thinkplus/warranty ↔ Post warranty maintenance services available ↔ 24 hour x 7 day¹⁴ toll-free support during the warranty period¹ via 800-426-7378 		
SATA cables	Two SATA cables (each 1-drop to device), three SATA connectors and one eSATA/SATA connector on planar				
eSATA port	None				
EIDE controller	None				
Diskette drive	None		Supports ThinkVantage® technologies RoHS-compliant		
Media reader	None				
Chipset	Intel Q35 Express Chipset; I/O Controller Hub 9 Digital Office (ICH9DO) for SATA 3.0Gb/s with RAID 0/1 support, PCI Express x1, ethernet (MAC), PCI 2.3, USB, LPC bus / SMSC® SCH5617 Super I/O for serial, parallel, diskette, hardware monitoring (temperature, voltage, fan speed)				
Front ports	Two USB 2.0, microphone (stereo, 3.5mm), headphone (stereo, 3.5mm)				
Rear ports	Six USB 2.0, serial (9-pin), parallel (25-pin), keyboard (PS/2), mouse (PS/2), ethernet (RJ-45), D5U: monitor (VGA DB-15, DVI-I), S-Video out; Others: monitor (VGA DB-15, DVI-D in some models)		Security		
Internal connector	Two USB 2.0 planar conn (1 used; one open for media reader or 2 rear USB ports)				
Rear audio ports	Line-in (stereo, 3.5mm), line-out (stereo, 3.5mm), microphone-in (stereo, 3.5mm)				
Audio	High Definition (HD) Audio, Analog Devices AD1882 codec				
Speaker	One internal speaker for business audio		Limited Warranty¹		
Ethernet	Gigabit ethernet on planar, Intel 82566DM (PHY layer; MAC in ICH9DO), PCIe x1, Intel AMT 3.0, Wake on LAN®, ASF2.0				
Intel AMT	Intel Active Management Technology (iAMT)				
Modem	None				
Security chip	Winbond® WPCT200 SafeKeeper™ Trusted Platform Module, TCG 1.2-compliant		Limited Warranty¹		
Keyboard	Preferred Pro USB Keyboard (USB connector), 104-key, black, Lenovo logo				
Mouse	Optical Wheel Mouse (USB connector), black, Lenovo logo				
Power supply	280 watts with variable speed fan, manual switch, two diagnostic LEDs				
Preloaded operating system²⁰			Accessories		
- <i>Some:</i> Microsoft® Windows® XP Professional with Vista® COA			1GB PC2-6400 NP DDR2 UDIMM 41U2977		
- <i>Some:</i> Microsoft Windows Vista Business Edition (32-bit)			2GB PC2-6400 NP DDR2 UDIMM 41U2978		
♦ Vista models: Vista Basic logo			Kensington Cable Lock from Lenovo 73P2582		
Preloaded applications⁵ (all OSes; only some listed)			ADD2 DVI-D Monitor Connection (HDCP) 43R1985		
• Rescue and Recovery™			ATI™ Radeon™ HD 2400 Pro 128MB 43R1961		
• Norton Internet Security™			ATI Radeon HD 2400 XT 256MB 43R1962		
• Diskeeper® Home			ATI Radeon HD 2600 XT 512MB 43R1963		
• Microsoft Office 2007 Trial (60-day)			NVIDIA® Quadro® 256MB NVS 290 43R1765		
			NVIDIA Quadro 256MB FX 370 43R1766		
			NVIDIA Quadro 512MB FX 1700 43R1767		
			Other accessories at lenovo.com/accessories		

See footnotes for important warranty information

US models announced August 19, 2008; previous models on January 22 or March 25, 2008

Name	Type-model	Slot x bay	Processor	GHz	L2 cache	Memory ⁸	SATA disk	SATA optical	Graphics	eSATA port	ENERGY STAR 4.0	Intel vPro	Vista preload	Vista logo	Global Educ	Avail date
M57p	9194-A1U	4x5	Core 2 Duo E6550	2.33	4MB	1GB	160GB ²	Combo	GMA	None	ES40	vPro	Bus32	Basic	None	Oct 07

- Intel Core 2 Processor with vPro™ Technology (includes Intel Active Management Technology)
- This model has a 3-year limited warranty¹

Positioning Processor	Ultimate enterprise stability and manageability for large enterprise										Tower			
Implementation	Intel® Core™ 2 Duo Processor E6550 with dual-core, Intel 64 Technology, Virtualization Technology, Execute Disable Bit, EIST, TXT, and 1333MHz system bus with 4MB shared L2 cache Processor in FC-LGA6 package in LGA775 socket										<ul style="list-style-type: none"> • Business black color; metal case • 6.9" W X 17.0" D X 15.7" H • 175mm W X 432mm D X 400mm H • 22.5 lb (10.2 kg) in max configuration • Handle on top front • Toolless cover removal • Toolless disk, diskette drive, optical drive removal • Toolless adapter retention 			
Memory	1GB std, 8GB max ⁸ , PC2-5300 667MHz DDR2, non-parity, dual-channel capable, four 240-pin DIMM sockets; Non-italics: standard memory in one socket; 3 sockets available										Bay ① 5.25", 1.6" high, access, std optical Bay ② 5.25", 1.6" high, access, open Bay ③ 3.5", 1" high, access, open (reader/diskette) Bay ④ 3.5", 1" high, no access, std disk Bay ⑤ 3.5", 1" high, no access, opt disk			
Graphics	Intel Graphics Media Accelerator 3100 (GMA 3100), integrated graphics in Q35, uses main memory (up to 256MB), one analog VGA DB-15 connector, supports dual independent display with optional ADD2 adapter										Slot 1: half-length, full-height, PCI Express x16 (75w max) Slot 2: half-length, full-height, PCI Express x1 Slot 3: half-length, full-height, 32-bit PCI 2.3 (5v) Slot 4: half-length, full-height, 32-bit PCI 2.3 (5v)			
SATA disk	160GB, SATA 3.0Gb/s 7200 rpm, vibration dampening mounts										Security <ul style="list-style-type: none"> • Security chip (see information on left) • One lock to secure both cover and entire system to fixed object: <ul style="list-style-type: none"> - Padlock loop (in rear for opt padlock) - Security slot (in rear for optional Kensington® Microsaver® cable) • Power-on password • Administrator password • Hard disk password • Boot sequence control • Boot without keyboard, mouse, diskette • Serial port I/O control • Parallel port I/O control • Individual USB port disablement 			
SATA controller	Serial ATA, SATA 3.0Gb/s, integrated in ICH9DO, RAID 0/1 support													
SATA Combo	CD-RW/DVD-ROM Combo SATA 1.5Gb/s Drive													
SATA cables	Two SATA cables (each 1-drop to device), three SATA connectors and one eSATA/SATA connector on planar													
eSATA port	None										Supports ThinkVantage® technologies			
EIDE controller	None													
Diskette drive	None													
Media reader	None													
Chipset	Intel Q35 Express Chipset; I/O Controller Hub 9 Digital Office (ICH9DO) for SATA 3.0Gb/s with RAID 0/1 support, PCI Express® x1, ethernet (MAC), PCI 2.3, USB, LPC bus / SMSC® SCH5617 Super I/O for serial, parallel, diskette, hardware monitoring (temperature, voltage, fan speed)										Supports ThinkVantage® technologies			
Front ports	Two USB 2.0, microphone (stereo, 3.5mm), headphone (stereo, 3.5mm)													
Rear ports	Six USB 2.0, serial (9-pin), parallel (25-pin), keyboard (PS/2), mouse (PS/2), ethernet (RJ-45), monitor (VGA DB-15)													
Internal connector	Two USB 2.0 planar conn (1 used; one open for media reader or 2 rear USB ports)													
Rear audio ports	Line-in (stereo, 3.5mm), line-out (stereo, 3.5mm), microphone-in (stereo, 3.5mm)										EPEAT™ Gold rating ENERGY STAR 4.0-compliant RoHS-compliant			
Audio	High Definition (HD) Audio, Analog Devices AD1882 codec													
Speaker	One internal speaker for business audio													
Ethernet	Gigabit ethernet on planar, Intel 82566DM (PHY layer; MAC in ICH9DO), PCIe x1, Intel AMT 3.0, Wake on LAN®, ASF2.0													
Intel AMT	Intel Active Management Technology (iAMT)										Limited Warranty¹ <ul style="list-style-type: none"> ↔ 3-year parts and labor ↔ International Warranty Service⁹ ↔ Customer Replaceable Unit (CRU) parts only (with limited onsite service for selected parts³, 8 am - 5 pm, Mon - Fri coverage excluding holidays, next business day response time) ↔ Onsite service upgrade options (in eligible locations):⁷ <ul style="list-style-type: none"> • 3-year LOR 9x5, 4 hour response (ThinkPlus™ part number 41C9192) • 3-year LOR 24x7, 4 hour response (ThinkPlus part number 41C9193) • 4-year LOR 9x5, Next Business Day (ThinkPlus part number 41C9194) • 4-year LOR 9x5, 4 hour response (ThinkPlus part number 41C9195) • 4-year LOR 24x7, 4 hour response (ThinkPlus part number 41C9196) ↔ ThinkPlus services at lenovo.com/thinkplus/warranty ↔ Post warranty maintenance services available ↔ 24 hour x 7 day¹⁴ toll-free support during the warranty period¹ via 800-426-7378 			
Modem	None													
Security chip	Winbond® WPCT200 SafeKeeper™ Trusted Platform Module, TCG 1.2-compliant													
Keyboard	Preferred Pro USB Keyboard (USB connector), 104-key, black, Lenovo logo													
Mouse	Optical Wheel Mouse (USB connector), black, Lenovo logo										Limited Warranty¹ <ul style="list-style-type: none"> ↔ 3-year parts and labor ↔ International Warranty Service⁹ ↔ Customer Replaceable Unit (CRU) parts only (with limited onsite service for selected parts³, 8 am - 5 pm, Mon - Fri coverage excluding holidays, next business day response time) ↔ Onsite service upgrade options (in eligible locations):⁷ <ul style="list-style-type: none"> • 3-year LOR 9x5, 4 hour response (ThinkPlus™ part number 41C9192) • 3-year LOR 24x7, 4 hour response (ThinkPlus part number 41C9193) • 4-year LOR 9x5, Next Business Day (ThinkPlus part number 41C9194) • 4-year LOR 9x5, 4 hour response (ThinkPlus part number 41C9195) • 4-year LOR 24x7, 4 hour response (ThinkPlus part number 41C9196) ↔ ThinkPlus services at lenovo.com/thinkplus/warranty ↔ Post warranty maintenance services available ↔ 24 hour x 7 day¹⁴ toll-free support during the warranty period¹ via 800-426-7378 			
Power supply	280 watts with variable speed fan, autosensing, two diagnostic LEDs, 80% PSU													
Preloaded operating system²⁰	Microsoft® Windows® Vista® Business Edition (32-bit)												Limited Warranty¹ <ul style="list-style-type: none"> ↔ 3-year parts and labor ↔ International Warranty Service⁹ ↔ Customer Replaceable Unit (CRU) parts only (with limited onsite service for selected parts³, 8 am - 5 pm, Mon - Fri coverage excluding holidays, next business day response time) ↔ Onsite service upgrade options (in eligible locations):⁷ <ul style="list-style-type: none"> • 3-year LOR 9x5, 4 hour response (ThinkPlus™ part number 41C9192) • 3-year LOR 24x7, 4 hour response (ThinkPlus part number 41C9193) • 4-year LOR 9x5, Next Business Day (ThinkPlus part number 41C9194) • 4-year LOR 9x5, 4 hour response (ThinkPlus part number 41C9195) • 4-year LOR 24x7, 4 hour response (ThinkPlus part number 41C9196) ↔ ThinkPlus services at lenovo.com/thinkplus/warranty ↔ Post warranty maintenance services available ↔ 24 hour x 7 day¹⁴ toll-free support during the warranty period¹ via 800-426-7378 	
Preloaded applications⁵	<ul style="list-style-type: none"> • Rescue and Recovery™ • Client Security Solution™ • ThinkVantage Productivity Center • ThinkVantage System Update • System Migration Assistant • Norton Internet Security™ (90 days of virus definitions) • Diskeeper® Home • PC-Doctor™ (diagnostics) • Adobe® Reader • Windows Live™ Toolbar • Windows Live Search • Picasa from Google • Microsoft Office 2007 Trial (60-day) • Sonic RecordNow and Drive Letter Access (combo) • Corel® WinDVD® (combo) 													
Accessories	1GB PC2-5300 CL5 NP DDR2 UDIMM 73P4984 2GB PC2-5300 CL5 NP DDR2 UDIMM 73P4985 1GB PC2-6400 NP DDR2 UDIMM 41U2977 2GB PC2-6400 NP DDR2 UDIMM 41U2978 250GB SATA 3.0Gb/s Disk (7200 rpm) 41N3015 500GB SATA 3.0Gb/s Disk (7200 rpm) 43R1990 USB 2.0 Lenovo Multimedia Headset 40Y8518 USB 2.0 Lenovo Webcam 40Y8519 USB 2.0 Essential Memory Key 32GB 45K1258 USB 2.0 Ultra Secure Memory Key 8GB 45J5918 USB 2.0 Portable Secure 320GB Hard Disk 43R2019 USB 2.0 Super Multi-Burner Drive 41N5565 Super Multi-Burner DL DVD±RW SATA Drive 41N5620 ThinkVision® L2240p Wide 22" Monitor 4422HB6 ThinkVision L2440p Wide 24" Monitor 4420HB2 Wireless Kbd & Opt Wheel Mouse (via USB) 73P4067 Kensington Cable Lock from Lenovo 73P2582 ADD2 DVI-D Monitor Connection (HDCP) 43R1985 ATI™ Radeon™ HD 2400 Pro 128MB 43R1961 ATI Radeon HD 2400 XT 256MB 43R1962 ATI Radeon HD 2600 XT 512MB 43R1963 NVIDIA® Quadro® 256MB NVS 290 43R1765 NVIDIA Quadro 256MB FX 370 43R1766 NVIDIA Quadro 512MB FX 1700 43R1767													
	Acc Guide in pdf lenovo.com/accessoriesguide Other accessories at lenovo.com/accessories													

See footnotes for important warranty information
 US model announced September 18, 2007

Partial list of accessories supported on ThinkCentre M57 and M57p

Memory

M57/M57p Eco Ultra Small 6395/6397 use notebook memory:
 1GB PC2-5300 DDR2 SODIMM (notebook) 43R1763 ann 03/04/08
 2GB PC2-5300 DDR2 SODIMM (notebook) 43R1756 ann 03/04/08

M57/M57p Ultra Small 6071/9071,
 M57/M57p Small 9970/6072/9181/9967/6073/9196, and
 M57/M57p Tower 9978/6075/9174/9979/9088/9194 use desktop
 memory:

512MB PC2-5300 CL5 NP DDR2 UDIMM 73P4983 ann 06/28/05
 1GB PC2-5300 CL5 NP DDR2 UDIMM 73P4984 ann 06/28/05
 2GB PC2-5300 CL5 NP DDR2 UDIMM 73P4985 ann 09/26/06
 512MB PC2-6400 NP DDR2 UDIMM⁴⁸ 41U2976 ann 09/26/06
 1GB PC2-6400 NP DDR2 UDIMM⁴⁸ 41U2977 ann 09/26/06
 2GB PC2-6400 NP DDR2 UDIMM⁴⁸ 41U2978 ann 01/08/08

⁴⁸ When PC2-6400 is installed with systems that have PC2-5300 memory, PC2-6400 will operate at the PC2-5300 memory speed.

Optical

M57/M57p Ultra Small 6071/9071 use
 Ultrabay™ Enhanced [12.7mm high] and Ultrabay Slim [9.5mm high]
 EIDE optical drives:
 CD-RW/DVD Combo Ultrabay Enhanced (cur)⁴⁷ 73P3275 ann 10/07/03
 ThinkPad DVD Ultrabay Slim Burner (flat)⁴⁷ 41N5643 ann 05/31/07
⁴⁷ Not supported by Lenovo

M57/M57p Eco Ultra Small 6395/6397,
 M57/M57p Small 9970/6072/9181/9967/6073/9196, and
 M57/M57p Tower 9978/6075/9174/9979/9088/9194
 support Serial ATA optical drives:
 DVD-ROM DL SATA 1.5Gb/s 16X-48X Max⁴ 41N5618 ann 09/26/06
 Super Multi-Burner DL DVD±RW SATA Drive 41N5620 ann 09/26/06

Storage and removable storage

All:
 80GB SATA 3.0Gb/s Disk (7200 rpm) 09N4253 ann 05/19/03
 160GB SATA 3.0Gb/s Disk (7200 rpm) 09N4254 ann 05/19/03
 250GB SATA 3.0Gb/s Disk (7200 rpm) 41N3015 ann 01/24/06
 500GB SATA 3.0Gb/s Disk (7200 rpm) 43R1990 ann 11/06/07

M57/M57p Eco Ultra Small 6395/6397 support:
 1TB SATA 3.0Gb/s Disk (7200 rpm) 45J7918 ann 08/19/08

All:
 USB Portable Diskette Drive 05K9276 ann 06/05/00
 USB 2.0 Essential Memory Key 1GB 41U4940 ann 01/23/07
 USB 2.0 Essential Memory Key 2GB 41U4944 ann 01/23/07
 USB 2.0 Essential Memory Key 4GB 45J7904 ann 06/24/08
 USB 2.0 Essential Memory Key 8GB 45J7905 ann 07/15/08
 USB 2.0 Essential Memory Key 32GB 45K1258 ann 10/28/08
 USB 2.0 Security Memory Key 1GB 41U5118 ann 07/17/07
 USB 2.0 Security Memory Key 2GB 41U5119 ann 07/17/07
 USB 2.0 Security Memory Key 4GB 41U5120 ann 07/17/07
 USB 2.0 Ultra Secure Memory Key 1GB 45J5915 ann 08/26/08
 USB 2.0 Ultra Secure Memory Key 2GB 45J5916 ann 08/26/08
 USB 2.0 Ultra Secure Memory Key 4GB 45J5917 ann 08/26/08
 USB 2.0 Ultra Secure Memory Key 8GB 45J5918 ann 08/26/08
 USB 2.0 Portable 160GB Hard Disk 43R1784 ann 09/23/08
 USB 2.0 Portable Secure 160GB Hard Disk 43R2018 ann 11/18/08
 USB 2.0 Portable Secure 320GB Hard Disk 43R2019 ann 11/18/08
 USB 2.0 CD-RW/DVD-ROM Combo II Drive 40Y8637 ann 01/05/06
 USB 2.0 Super Multi-Burner Drive 41N5565 ann 01/23/07

Graphics

M57/M57p Small 9970/6072/9181/9967/6073/9196 support Low Profile
 35 watts max:
 ADD2 DVI-D Monitor Connection (HDCP) 43R1985 ann 11/06/07
 ATI™ Radeon™ HD 2400 Pro 128MB 43R1961 ann 11/06/07
 ATI Radeon HD 2400 XT 256MB 43R1962 ann 11/06/07

M57/M57p Tower 9978/6075/9174/9979/9088/9194 support 75 watts
 max:
 ADD2 DVI-D Monitor Connection (HDCP) 43R1985 ann 11/06/07
 ATI Radeon HD 2400 Pro 128MB 43R1961 ann 11/06/07
 ATI Radeon HD 2400 XT 256MB 43R1962 ann 11/06/07
 ATI Radeon HD 2600 XT 512MB 43R1963 ann 11/06/07
 NVIDIA® Quadro® 256MB NVS 290 43R1765 ann 12/18/07
 NVIDIA Quadro 256MB FX 370 43R1766 ann 12/18/07
 NVIDIA Quadro 512MB FX 1700 43R1767 ann 12/18/07

More information at www.lenovo.com/support/graphiccards

Keyboard

Preferred Pro USB Keyboard 73P5220 ann 06/21/05
 Preferred Pro Full Size PS/2 Keyboard 31P7415 ann 06/04/02
 Enhanced Performance USB Keyboard 73P2620 ann 03/23/04
 Wireless Kbd & Opt Wheel Mouse (via USB) 73P4067 ann 12/07/04
 USB Travel Keyboard with UltraNav™ 31P9490 ann 04/27/04
 Lenovo USB Fingerprint Keyboard 73P4730 ann 02/22/05

More information at www.lenovo.com/support/keyboards

Mouse

Optical Wheel Mouse (USB) 06P4069 ann 05/21/03
 Optical ScrollPoint® Mouse (USB, PS/2) 31P7405 ann 08/27/02
 Laser Tilt Wheel Mouse (USB, PS/2) 41U3074 ann 01/23/07
 Lenovo Wireless Laser Mouse (blk, via USB) 45K1696 ann 11/25/08
 Lenovo Wireless Laser Mouse (red, via USB) 51J0198 ann 11/25/08

More information at www.lenovo.com/support/mice

Multimedia

USB 2.0 Lenovo Multimedia Headset 40Y8518 ann 06/27/06
 USB 2.0 Lenovo Webcam 40Y8519 ann 08/29/06

Security

Kensington® Cable Lock from Lenovo 73P2582 ann 12/29/03
 Kensington Twin Head Cable Lock 45K1620 ann 09/30/08
 USB Gemplus GemPC Smart Card Reader 41N3040 ann 02/21/06

Mounting Device

M57/M57p Eco Ultra Small 6395/6397 and M57/M57p Ultra Small
 6071/9071 support under desk mounting device:
 ThinkCentre Ultra Small Under Desk Mount 40Y8625 ann 09/06/05

Monitors

ThinkVision® L174 17" Monitor 9227AE1 ann 04/15/08
 ThinkVision L1700p 17" Monitor 9417HE2 ann 09/17/08
 ThinkVision L1900p 19" Monitor 4431HE1 ann 11/11/08
 ThinkVision L1940p Wide 19" Monitor 4424HB6 ann 09/17/08
 ThinkVision L200p Wide 20.1" Monitor 4438HB6 ann 04/15/08
 ThinkVision L2240p Wide 22" Monitor 4422HB6 ann 09/17/08
 ThinkVision L2440p Wide 24" Monitor 4420HB2 ann 09/17/08
 ThinkVision L2440x Wide 24" Monitor 4421HB2 ann 09/17/08

More information at www.lenovo.com/thinkvision

Monitor Accessories⁴⁶

M57/M57p Eco Ultra Small 6395/6397 support:
 Lenovo Vertical PC and Monitor Stand 41R4359 ann 02/19/08

All:
 ThinkVision USB Soundbar 40Y7616 ann 08/23/05
 ThinkVision Soundbar (L1900p, 24" Wide) 45K1263 ann 09/16/08
 Kensington Cable Lock from Lenovo 73P2582 ann 12/29/03
 Kensington Twin Head Cable Lock 45K1620 ann 09/30/08
 Radial Arm 19K4464 ann 05/05/00

⁴⁶ Compatible on selected Lenovo and ThinkVision monitors.

More information at www.lenovo.com/support/monitoraccessories

Medialess License Key (MLK)

Microsoft® Office 2007 Basic, English 43R1528 ann 01/31/07
 Microsoft Office 2007 Small Business, Engl 43R1534 ann 01/31/07
 Microsoft Office 2007 Professional, English 43R1531 ann 01/31/07

Other accessories at www.lenovo.com/accessories

Accessories Guide pdf at www.lenovo.com/accessoriesguide



Lenovo ThinkCentre M58 Eco Ultra Small



Lenovo ThinkCentre M58 Eco Ultra Small with dual Lenovo ThinkVision monitors



Lenovo ThinkCentre M58 Small



Lenovo ThinkCentre M58 Small with Lenovo ThinkVision monitor



Lenovo ThinkCentre M58 Tower



Lenovo ThinkCentre M58 Tower with dual Lenovo ThinkVision monitors

ThinkCentre® M58 Eco Ultra Small (8820) - TopSeller

Personal Systems Reference (PSREF)

Name	Type-model	Slot x bay	Processor	GHz	Cores	Memory ⁸	SATA disk	SATA optical	Graphics	Monitor connectors	DisplayPort dongle	ENERGY STAR 4.0	Intel vPro Preload	Global Educ	Avail date
M58	8820-A3U	1x2	Celeron E1200	1.60	2	1GB	160GB ² DVD	GMA	VGA, DP	None	ES40	No	XP Pro	No	Dec 08
M58	8820-A4U	1x2	Pentium E5200	2.50	2	1GB	160GB DVD±RW	GMA	VGA, DP	None	ES40	No	XP Pro	No	Dec 08

- **These small and medium business (SMB) models are part of the US TopSeller™ Program**
- **These models have a 3-year limited warranty¹**

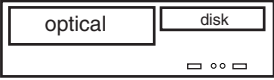
Positioning Processor	<p><i>Ultimate stability for small and medium businesses</i></p> <p>Intel® Celeron® Dual-Core Processor E1200 with dual-core, 800MHz system bus, and 512KB L2 cache or Intel Pentium® Dual-Core Processor E5200 with dual-core, 800MHz system bus, and 2MB L2 cache</p> <p>Processor in FC-LGA6 package in LGA775 socket</p>		<p>Eco Ultra Small</p> 
Implementation	<p>Processor in FC-LGA6 package in LGA775 socket</p>		<p>Bay ① 5.25", 1.6" high, access, std optical</p> <p>Bay ② 3.5", 1" high, no access, std disk</p> <p>Slot 1: Low Profile, 32-bit PCI 2.3</p> <ul style="list-style-type: none"> • Business black color; metal case • 10.8" W X 9.4" D X 3.1" H • 275mm W X 238mm D X 80mm H • 9.2 lb (4.2 kg) in maximum configuration • Hinged toolless cover for easy serviceability • Toolless disk and optical drive removal • Toolless systemboard retention • System floor stand for vertical orientation
Memory	<p>1GB std, 4GB max⁸, PC3-8500 1066MHz DDR3, non-parity, dual-channel capable, two 204-pin SODIMM sockets (notebook); <i>Non-italics</i>: standard memory in one socket; one socket available</p>		
Graphics	<p>Intel Graphics Media Accelerator 4500 (GMA 4500), integrated graphics in Q45, uses main memory (up to 512MB), one analog VGA DB-15 connector, one DisplayPort™ connector (supports single-link DVI-D via cable 45J7915), HDCP, DirectX® 10, supports dual independent display</p>		<p>Security</p> <ul style="list-style-type: none"> • Security chip (see information on left) • Security slot (in rear for attachment of optional Kensington® Microsaver® cable) - security slot and cover release button are combined into one latch for improved chassis security • Power-on password • Administrator password • Hard disk password (user and master) • Boot sequence control • Boot without diskette, keyboard • Individual USB port disablement <p>Supports ThinkVantage® technologies</p> <p>EPEAT™ Gold rating ENERGY STAR® 4.0-compliant GREENGUARD® certified RoHS-compliant</p> <p>Limited Warranty¹</p> <ul style="list-style-type: none"> ↪ 3-year parts and labor ↪ International Warranty Service⁹ ↪ Customer Replaceable Unit (CRU) parts only (with limited onsite service for selected parts³, 8 am - 5 pm, Mon - Fri coverage excluding holidays, next business day response time) ↪ Onsite service upgrade options (in eligible locations):⁷ <ul style="list-style-type: none"> • 3-year LOR 9x5, 4 hour response (ThinkPlus™ part number 41C9192) • 3-year LOR 24x7, 4 hour response (ThinkPlus part number 41C9193) • 4-year LOR 9x5, Next Business Day (ThinkPlus part number 41C9194) • 4-year LOR 9x5, 4 hour response (ThinkPlus part number 41C9195) • 4-year LOR 24x7, 4 hour response (ThinkPlus part number 41C9196) ↪ ThinkPlus services at lenovo.com/thinkplus/warranty ↪ Post warranty maintenance services available ↪ 24 hour x 7 day¹⁴ toll-free support during the warranty period¹ via 800-426-7378
SATA disk	<p>160GB, SATA 3.0Gb/s 7200 rpm, vibration dampening mounts</p>		
SATA controller	<p>Serial ATA, SATA 3.0Gb/s, integrated in ICH10DO, RAID 0/1</p>		
SATA DVD	<p><i>Some</i>: DVD-ROM DL SATA 1.5Gb/s 16-48X Max⁴ Drive (41N5618)</p>		
SATA DVD±RW	<p><i>Some</i>: Super Multi-Burner DL DVD±RW SATA 1.5Gb/s Drive (41N5620)</p>		
SATA cables	<p>Two SATA cables (each 1-drop to device), two SATA connectors and one eSATA connector on planar</p>		
eSATA port	<p>None</p>		
Diskette drive	<p>None</p>		
Media reader	<p>None</p>		
Chipset	<p>Intel Q45 Express Chipset (PCI Express® 2.0 x16), I/O Controller Hub 10 Digital Office [ICH10DO] (SATA 3.0Gb/s with RAID 0/1 support, PCI Express x1, ethernet MAC, PCI 2.3, USB, LPC bus), SMSC® SCH5617 Super I/O</p>		
Front ports	<p>Two USB 2.0, microphone (stereo, 3.5mm), headphone (stereo, 3.5mm)</p>		
Rear ports	<p>Six USB 2.0, ethernet (RJ-45), monitor (VGA DB-15, DisplayPort)</p>		
Internal connector	<p>Two USB 2.0 planar conn (1 used; one open for media reader or 2 rear USB ports)</p>		
Rear audio ports	<p>Line-in (stereo, 3.5mm), line-out (stereo, 3.5mm), microphone (stereo, 3.5mm)</p>		
Audio	<p>High Definition (HD) Audio, Analog Devices AD1882 codec</p>		
Speaker	<p>One internal speaker for business audio</p>		
Ethernet	<p>Gigabit ethernet on planar, Intel 82567LM, Wake on LAN®, ASF2.0, DASH 1.0</p>		
Intel AMT	<p>None</p>		
Modem	<p>None</p>		
Security chip	<p>Winbond® WPCT200 SafeKeeper™ Trusted Platform Module, TCG 1.2-compliant</p>		
Keyboard	<p>Preferred Pro USB Keyboard (USB connector), 104-key, black, Lenovo logo</p>		
Mouse	<p>Optical Wheel Mouse (USB connector), 400 dpi, black, Lenovo logo</p>		
Power supply	<p>External AC/DC adapter, 130 watts, autosensing, 87% PSU</p>		
Preloaded operating system²⁰	<p>Accessories</p>		
- Microsoft® Windows® XP Professional with Vista® COA	<p>1GB PC3-8500 DDR3 SODIMM (notebook) 43R1987</p>		
↕ Disk-to-Disk Recovery (in hidden protected area)	<p>2GB PC3-8500 DDR3 SODIMM (notebook) 43R1988</p>		
↕ Vista Basic logo	<p>500GB SATA 3.0Gb/s Disk (7200 rpm) 43R1990</p>		
Preloaded applications⁵	<p>1TB SATA 3.0Gb/s Disk (7200 rpm) 45J7918</p>		
• Rescue and Recovery™	<p>USB Portable Diskette Drive 05K9276</p>		
• Client Security Solution™	<p>USB 2.0 Lenovo Multimedia Headset 40Y8518</p>		
• ThinkVantage Productivity Center	<p>USB 2.0 Lenovo Webcam 40Y8519</p>		
• ThinkVantage System Update	<p>USB 2.0 Essential Memory Key 32GB 45K1258</p>		
• Norton Internet Security™ (90 days of virus definitions)	<p>USB 2.0 Ultra Secure Memory Key 2GB 45J5916</p>		
• Diskeeper® Home	<p>USB 2.0 Ultra Secure Memory Key 4GB 45J5917</p>		
• PC-Doctor™ (diagnostics)	<p>USB 2.0 Ultra Secure Memory Key 8GB 45J5918</p>		
• Adobe® Reader	<p>USB 2.0 Portable 160GB Hard Disk 43R1784</p>		
• Windows Live™ Toolbar	<p>USB 2.0 Portable 320GB Hard Disk 43R2019</p>		
• Windows Live Search	<p>USB 2.0 Super Multi-Burner Drive 41N5565</p>		
• Picasa from Google	<p>ThinkVision® L2440x Wide 24" Monitor 4421HB2</p>		
• Microsoft Office 2007 Trial (60-day)	<p>DisplayPort to Single-link DVI-D Cable 45J7915</p>		
• Multimedia Center for Think Offerings (DVD, DVD±RW)	<p>ThinkCentre Ultra Small Under Desk Mount 40Y8625</p>		
• Sonic RecordNow and Drive Letter Access (DVD±RW)	<p>Wireless Kbd & Opt Wheel Mouse (via USB) 73P4067</p>		
• Corel® WinDVD® (DVD, DVD±RW)	<p>Lenovo USB Fingerprint Keyboard 73P4730</p>		
• Corel WinDVD Creator (DVD±RW)	<p>Laser Tilt Wheel Mouse (USB, PS/2) 41U3074</p>		
	<p>Kensington Cable Lock from Lenovo 73P2582</p>		
	<p>Kensington Twin Head Cable Lock 45K1620</p>		
	<p>Acc Guide in pdf lenovo.com/accessoriesguide</p>		
	<p>Other accessories at lenovo.com/accessories</p>		

See footnotes for important warranty information
US models announced November 11, 2008

ThinkCentre® M58 Eco Ultra Small (7359)

Personal Systems Reference (PSREF)

Name	Type-model	Slot x bay	Processor	GHz	Cores	Memory ^a	SATA disk	SATA optical	Graphics	Monitor conn	DisplayPort dongle	ENERGY STAR 4.0	Intel vPro	Vista preload	Global Educ	Avail date
M58	7359-A6U	1x2	Pentium E2200	2.20	2	1GB	160GB ²	DVD	GMA	VGA, DP		ES40	No	Bus32	No	Dec 08
M58	7359-AGU	1x2	Pentium E2200	2.20	2	2GB	160GB	DVD±RW	GMA	VGA, DP	DP-to-DVI-D	ES40	No	Bus32	No	Dec 08
M58	7359-ABU	1x2	Pentium E2220	2.40	2	1GB	160GB	DVD±RW	GMA	VGA, DP		ES40	No	Bus32	No	Dec 08
M58	7359-ADU	1x2	Pentium E5200	2.50	2	2GB	160GB	DVD	GMA	VGA, DP	DP-to-DVI-D	ES40	No	Bus32	No	Dec 08
M58	7359-AEU	1x2	Core 2 Duo E7300	2.66	2	1GB	160GB	DVD	GMA	VGA, DP	DP-to-DVI-D	ES40	No	Bus32	No	Dec 08
M58	7359-AFU	1x2	Core 2 Duo E7300	2.66	2	2GB	160GB	DVD±RW	GMA	VGA, DP	DP-to-DVI-D	ES40	No	Bus32	No	Dec 08

• **These models have a 3-year limited warranty¹**

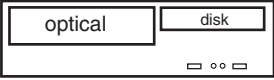
Positioning Processor	<p><i>Ultimate stability for small and medium businesses</i></p> <p>Intel® Pentium® Dual-Core Processor E2200 or E2220 with dual-core, 800MHz system bus, and 1MB L2 cache or Intel Pentium Dual-Core Processor E5200 with dual-core, 800MHz system bus, and 2MB L2 cache or Intel Core™ 2 Duo Processor E7300 with dual-core, 1066MHz system bus, and 3MB L2 cache</p> <p>Processor in FC-LGA6 or FC-LGA8 package in LGA775 socket</p>		<p>Eco Ultra Small</p>  <p>Bay ① 5.25", 1.6" high, access, std optical Bay ② 3.5", 1" high, no access, std disk</p> <p>Slot 1: Low Profile, 32-bit PCI 2.3</p> <ul style="list-style-type: none"> • Business black color; metal case • 10.8" W X 9.4" D X 3.1" H • 275mm W X 238mm D X 80mm H • 9.2 lb (4.2 kg) in maximum configuration • Hinged toolless cover for easy serviceability • Toolless disk and optical drive removal • Toolless systemboard retention • System floor stand for vertical orientation 																																											
Memory	<p>1GB or 2GB std, 4GB max⁸, PC3-8500 1066MHz DDR3, non-parity, dual-channel capable, two 204-pin SODIMM sockets (notebook); <i>Italics</i>: standard memory in both sockets; no sockets available; <i>Non-italics</i>: standard memory in one socket; one socket available</p>		<p>Security</p> <ul style="list-style-type: none"> • Security chip (see information on left) • Security slot (in rear for attachment of optional Kensington® Microsaver® cable) - security slot and cover release button are combined into one latch for improved chassis security • Power-on password • Administrator password • Hard disk password (user and master) • Boot sequence control • Boot without diskette, keyboard • Individual USB port disablement 																																											
Graphics	<p>Intel Graphics Media Accelerator 4500 (GMA 4500), integrated graphics in Q45, uses main memory (up to 253MB [<i>1GB system mem</i>], 765MB [<i>2GB system mem</i>]), one analog VGA DB-15 connector, one DisplayPort™ connector, HDCP, DirectX® 10, supports dual independent display</p> <p><i>Some</i>: DisplayPort to Single-link DVI-D Cable (45J7915)</p>																																													
DP dongle			<p>Supports ThinkVantage® technologies</p> <p>EPEAT™ Gold rating ENERGY STAR® 4.0-compliant GREENGUARD® certified RoHS-compliant</p>																																											
SATA disk	<p>160GB, SATA 3.0Gb/s 7200 rpm, vibration dampening mounts</p>																																													
SATA controller	<p>Serial ATA, SATA 3.0Gb/s, integrated in ICH10DO, RAID 0/1 support</p>		<p>Limited Warranty¹</p> <ul style="list-style-type: none"> ↪ 3-year parts and labor ↪ International Warranty Service⁹ ↪ Customer Replaceable Unit (CRU) parts only (with limited onsite service for selected parts³, 8 am - 5 pm, Mon - Fri coverage excluding holidays, next business day response time) ↪ Onsite service upgrade options (in eligible locations):⁷ <ul style="list-style-type: none"> • 3-year LOR 9x5, 4 hour response (ThinkPlus™ part number 41C9192) • 3-year LOR 24x7, 4 hour response (ThinkPlus part number 41C9193) • 4-year LOR 9x5, Next Business Day (ThinkPlus part number 41C9194) • 4-year LOR 9x5, 4 hour response (ThinkPlus part number 41C9195) • 4-year LOR 24x7, 4 hour response (ThinkPlus part number 41C9196) ↪ ThinkPlus services at lenovo.com/thinkplus/warranty ↪ Post warranty maintenance services available ↪ 24 hour x 7 day¹⁴ toll-free support during the warranty period¹ via 800-426-7378 																																											
SATA DVD	<p><i>Some</i>: DVD-ROM DL SATA 1.5Gb/s 16-48X Max⁴ Drive (41N5618)</p>																																													
SATA DVD±RW	<p><i>Some</i>: Super Multi-Burner DL DVD±RW SATA 1.5Gb/s Drive (41N5620)</p>																																													
SATA cables	<p>Two SATA cables (each 1-drop to device), two SATA connectors and one eSATA connector on planar</p>																																													
eSATA port	None																																													
Diskette drive	None																																													
Media reader	None																																													
Chipset	<p>Intel Q45 Express Chipset (PCI Express® 2.0 x16), I/O Controller Hub 10 Digital Office [ICH10DO] (SATA 3.0Gb/s with RAID 0/1 support, PCI Express x1, ethernet MAC, PCI 2.3, USB, LPC bus), SMSC® SCH5617 Super I/O</p>																																													
Front ports	Two USB 2.0, microphone (stereo, 3.5mm), headphone (stereo, 3.5mm)																																													
Rear ports	Six USB 2.0, ethernet (RJ-45), monitor (VGA DB-15, DisplayPort)																																													
Internal connector	Two USB 2.0 planar conn (1 used; one open for media reader or 2 rear USB ports)																																													
Rear audio ports	Line-in (stereo, 3.5mm), line-out (stereo, 3.5mm), microphone (stereo, 3.5mm)																																													
Audio	High Definition (HD) Audio, Analog Devices AD1882 codec																																													
Speaker	One internal speaker for business audio																																													
Ethernet	Gigabit ethernet on planar, Intel 82567LM, Wake on LAN®, ASF2.0, DASH 1.0																																													
Intel AMT	None																																													
Modem	None																																													
Security chip	Winbond® WPCT200 SafeKeeper™ Trusted Platform Module, TCG 1.2-compliant																																													
Keyboard	Preferred Pro USB Keyboard (USB connector), 104-key, black, Lenovo logo																																													
Mouse	Optical Wheel Mouse (USB connector), 400 dpi, black, Lenovo logo																																													
Power supply	External AC/DC adapter, 130 watts, autosensing, 87% PSU																																													
Preloaded operating system²⁰	<p>- Microsoft® Windows® Vista® Business Edition (32-bit)</p> <p>↪ Vista Premium logo</p>																																													
Preloaded applications⁵	<ul style="list-style-type: none"> • Rescue and Recovery™ • Client Security Solution™ • ThinkVantage Productivity Center • ThinkVantage System Update • ThinkVantage Power Manager • Norton Internet Security™ (90 days of virus definitions) • Diskeeper® Home • PC-Doctor™ (diagnostics) • Adobe® Reader • Windows Live™ Toolbar • Windows Live Search • Picasa from Google • Microsoft Office 2007 Trial (60-day) • Sonic RecordNow and Drive Letter Access (DVD±RW) • Corel® WinDVD® (DVD, DVD±RW) 																																													
Accessories	<table border="0"> <tr> <td>1GB PC3-8500 DDR3 SODIMM (notebook)</td> <td>43R1987</td> </tr> <tr> <td>2GB PC3-8500 DDR3 SODIMM (notebook)</td> <td>43R1988</td> </tr> <tr> <td>500GB SATA 3.0Gb/s Disk (7200 rpm)</td> <td>43R1990</td> </tr> <tr> <td>1TB SATA 3.0Gb/s Disk (7200 rpm)</td> <td>45J7918</td> </tr> <tr> <td>USB Portable Diskette Drive</td> <td>05K9276</td> </tr> <tr> <td>USB 2.0 Lenovo Multimedia Headset</td> <td>40Y8518</td> </tr> <tr> <td>USB 2.0 Lenovo Webcam</td> <td>40Y8519</td> </tr> <tr> <td>USB 2.0 Essential Memory Key 32GB</td> <td>45K1258</td> </tr> <tr> <td>USB 2.0 Ultra Secure Memory Key 2GB</td> <td>45J5916</td> </tr> <tr> <td>USB 2.0 Ultra Secure Memory Key 4GB</td> <td>45J5917</td> </tr> <tr> <td>USB 2.0 Ultra Secure Memory Key 8GB</td> <td>45J5918</td> </tr> <tr> <td>USB 2.0 Portable Secure 320GB Hard Disk</td> <td>43R2019</td> </tr> <tr> <td>USB 2.0 Super Multi-Burner Drive</td> <td>41N5565</td> </tr> <tr> <td>ThinkVision® L2440x Wide 24" Monitor</td> <td>4421HB2</td> </tr> <tr> <td>ThinkCentre Ultra Small Under Desk Mount</td> <td>40Y8625</td> </tr> <tr> <td>Wireless Kbd & Opt Wheel Mouse (via USB)</td> <td>73P4067</td> </tr> <tr> <td>Lenovo USB Fingerprint Keyboard</td> <td>73P4730</td> </tr> <tr> <td>Laser Tilt Wheel Mouse (USB, PS/2)</td> <td>41U3074</td> </tr> <tr> <td>Kensington Cable Lock from Lenovo</td> <td>73P2582</td> </tr> <tr> <td>Kensington Twin Head Cable Lock</td> <td>45K1620</td> </tr> <tr> <td>Acc Guide in pdf lenovo.com/accessoriesguide</td> <td></td> </tr> <tr> <td>Other accessories at lenovo.com/accessories</td> <td></td> </tr> </table>		1GB PC3-8500 DDR3 SODIMM (notebook)	43R1987	2GB PC3-8500 DDR3 SODIMM (notebook)	43R1988	500GB SATA 3.0Gb/s Disk (7200 rpm)	43R1990	1TB SATA 3.0Gb/s Disk (7200 rpm)	45J7918	USB Portable Diskette Drive	05K9276	USB 2.0 Lenovo Multimedia Headset	40Y8518	USB 2.0 Lenovo Webcam	40Y8519	USB 2.0 Essential Memory Key 32GB	45K1258	USB 2.0 Ultra Secure Memory Key 2GB	45J5916	USB 2.0 Ultra Secure Memory Key 4GB	45J5917	USB 2.0 Ultra Secure Memory Key 8GB	45J5918	USB 2.0 Portable Secure 320GB Hard Disk	43R2019	USB 2.0 Super Multi-Burner Drive	41N5565	ThinkVision® L2440x Wide 24" Monitor	4421HB2	ThinkCentre Ultra Small Under Desk Mount	40Y8625	Wireless Kbd & Opt Wheel Mouse (via USB)	73P4067	Lenovo USB Fingerprint Keyboard	73P4730	Laser Tilt Wheel Mouse (USB, PS/2)	41U3074	Kensington Cable Lock from Lenovo	73P2582	Kensington Twin Head Cable Lock	45K1620	Acc Guide in pdf lenovo.com/accessoriesguide		Other accessories at lenovo.com/accessories	
1GB PC3-8500 DDR3 SODIMM (notebook)	43R1987																																													
2GB PC3-8500 DDR3 SODIMM (notebook)	43R1988																																													
500GB SATA 3.0Gb/s Disk (7200 rpm)	43R1990																																													
1TB SATA 3.0Gb/s Disk (7200 rpm)	45J7918																																													
USB Portable Diskette Drive	05K9276																																													
USB 2.0 Lenovo Multimedia Headset	40Y8518																																													
USB 2.0 Lenovo Webcam	40Y8519																																													
USB 2.0 Essential Memory Key 32GB	45K1258																																													
USB 2.0 Ultra Secure Memory Key 2GB	45J5916																																													
USB 2.0 Ultra Secure Memory Key 4GB	45J5917																																													
USB 2.0 Ultra Secure Memory Key 8GB	45J5918																																													
USB 2.0 Portable Secure 320GB Hard Disk	43R2019																																													
USB 2.0 Super Multi-Burner Drive	41N5565																																													
ThinkVision® L2440x Wide 24" Monitor	4421HB2																																													
ThinkCentre Ultra Small Under Desk Mount	40Y8625																																													
Wireless Kbd & Opt Wheel Mouse (via USB)	73P4067																																													
Lenovo USB Fingerprint Keyboard	73P4730																																													
Laser Tilt Wheel Mouse (USB, PS/2)	41U3074																																													
Kensington Cable Lock from Lenovo	73P2582																																													
Kensington Twin Head Cable Lock	45K1620																																													
Acc Guide in pdf lenovo.com/accessoriesguide																																														
Other accessories at lenovo.com/accessories																																														

See footnotes for important warranty information
US models announced November 11, 2008

ThinkCentre® M58 Small (8910) - TopSeller

Personal Systems Reference (PSREF)

Name	Type-model	Slot x bay	Processor	GHz	Cores	Memory ⁸	SATA disk	SATA optical	Graphics	Monitor connectors	DisplayPort dongle	Intel vPro	Preload	Global Educ	Avail date
M58	8910-A8U	2x3	Pentium E5200	2.50	2	1GB	160GB ²	DVD	GMA	VGA, DP	None	None	XP Pro	None	Nov 08
M58	8910-A9U	2x3	Core 2 Duo E7300	2.66	2	1GB	160GB	DVD±RW	GMA	VGA, DP	None	None	XP Pro	None	Nov 08
M58	8910-ABU	2x3	Core 2 Quad Q8200	2.33	4	2GB	250GB	DVD±RW	GMA	VGA, DP	None	None	XP Pro	None	Nov 08

- **These small and medium business (SMB) models are part of the US TopSeller™ Program**
- **These models have a 3-year limited warranty¹**

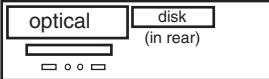
Positioning Processor	<p><i>Ultimate stability for small and medium businesses</i></p> <p>Intel® Pentium® Dual-Core Processor E5200 with dual-core, 800MHz system bus, and 2MB L2 cache or Intel Core™ 2 Duo Processor E7300 with dual-core, 1066MHz system bus, and 3MB L2 cache or Intel Core 2 Quad Processor Q8200 with quad-core, 1333MHz system bus, and 4MB L2 cache</p> <p>Processor in FC-LGA6 or FC-LGA8 package in LGA775 socket</p>		<p>Small</p> 
Implementation	<p>Slot 1: Low Profile, PCI Express 2.0 x16</p> <p>Slot 2: Low Profile, 32-bit PCI 2.3</p>		<p>Bay ① 5.25", 1.6" high, access, std optical</p> <p>Bay ② 3.5", 1" high, no access, std disk</p> <p>Bay ③ 3.5", .5" high, access, open (reader)</p>
Memory	<p>1GB or 2GB std, 8GB max⁸, PC3-8500 1066MHz DDR3, non-parity, dual-channel capable, four 240-pin DIMM sockets;</p> <p><i>Italics:</i> standard memory in two sockets; two sockets available;</p> <p><i>Non-italics:</i> standard memory in one socket; 3 sockets available</p>		
Graphics	<p>Intel Graphics Media Accelerator 4500 (GMA 4500), integrated graphics in Q45, uses main memory (up to 512MB [<i>1GB system mem</i>], 1GB [<i>2GB system mem</i>]), one analog VGA DB-15 conn, one DisplayPort™ conn (supports single-link DVI-D via cable 45J7915), HDCP, DirectX® 10, supports dual independent display</p>		<p>• Business black color; metal case</p> <p>• 12.5" W X 14.0" D X 3.9" H</p> <p>• 317mm W X 355mm D X 99mm H</p> <p>• 16.5 lb (7.5 kg) in maximum configuration</p> <p>• Toolless cover flips up and tilts backward on rear hinges</p> <p>• Toolless disk, optical drive removal</p> <p>• Toolless adapter retention</p> <p>• Toolless systemboard retention</p> <p>• System floor stand for vertical orientation</p>
SATA disk	<p>160GB or 250GB, SATA 3.0Gb/s 7200 rpm, vibration dampening</p>		
SATA controller	<p>Serial ATA, SATA 3.0Gb/s, integrated in ICH10DO, RAID 0/1 support</p>		<p>Security</p> <ul style="list-style-type: none"> • Security chip (see information on left) • Security slot (in rear for attachment of optional Kensington® Microsaver® cable) - optional cable also locks the cover by deactivating the cover release buttons • Power-on password • Administrator password • Hard disk password (user and master) • Boot sequence control • Boot without diskette, keyboard • Serial port I/O control • Individual USB port disablement
SATA DVD	<p><i>Some:</i> DVD-ROM DL SATA 1.5Gb/s 16-48X Max⁴ Drive (41N5618)</p>		
SATA DVD±RW	<p><i>Some:</i> Super Multi-Burner DL DVD±RW SATA 1.5Gb/s Drive (41N5620)</p>		
SATA cables	<p>Two SATA cables (each 1-drop to device), two SATA connectors on planar</p>		
eSATA port	<p>One external SATA (eSATA) port</p>		
Diskette drive	<p>None</p>		
Media reader	<p>None</p>		
Chipset	<p>Intel Q45 Express Chipset (PCI Express® 2.0 x16), I/O Controller Hub 10 Digital Office [ICH10DO] (SATA 3.0Gb/s with RAID 0/1 support, PCI Express x1, ethernet MAC, PCI 2.3, USB, LPC bus), SMSC® SCH5617 Super I/O</p>		
Front ports	<p>Two USB 2.0, microphone (stereo, 3.5mm), headphone (stereo, 3.5mm)</p>		
Rear ports	<p>Six USB 2.0, serial (9-pin), ethernet (RJ-45), monitor (VGA DB-15, DisplayPort), eSATA</p>		
Internal connector	<p>Two USB 2.0 planar conn (1 used; one open for media reader or 2 rear USB ports)</p>		
Rear audio ports	<p>Line-in (stereo, 3.5mm), line-out (stereo, 3.5mm), microphone-in (stereo, 3.5mm)</p>		
Audio	<p>High Definition (HD) Audio, Analog Devices AD1882 codec</p>		
Speaker	<p>One internal speaker for business audio</p>		
Ethernet	<p>Gigabit ethernet on planar, Intel 82567LM, Wake on LAN®, ASF2.0, DASH 1.0</p>		
Intel AMT	<p>None</p>		
Modem	<p>None</p>		
Security chip	<p>Winbond® WPCT200 SafeKeeper™ Trusted Platform Module, TCG 1.2-compliant</p>		
Keyboard	<p>Preferred Pro USB Keyboard (USB connector), 104-key, black, Lenovo logo</p>		<p>Supports ThinkVantage® technologies</p>
Mouse	<p>Optical Wheel Mouse (USB connector), 400 dpi, black, Lenovo logo</p>		
Power supply	<p>280 watts with variable speed fan, autosensing, two diagnostic LEDs</p>		<p>GREENGUARD® certified</p> <p>RoHS-compliant</p>
Preloaded operating system²⁰	<p>Accessories</p>		
- Microsoft® Windows® XP Professional with Vista® COA	<p>1GB PC3-8500 DDR3 UDIMM 45J5434</p>		
◇ Disk-to-Disk Recovery (in hidden protected area)	<p>2GB PC3-8500 DDR3 UDIMM 45J5435</p>		
◇ Vista Basic logo	<p>500GB SATA 3.0Gb/s Disk (7200 rpm) 43R1990</p>		
Preloaded applications⁵	<p>1TB SATA 3.0Gb/s Disk (7200 rpm) 45J7918</p>		
• Rescue and Recovery™	<p>USB Portable Diskette Drive 05K9276</p>		
• Client Security Solution™	<p>USB 2.0 Lenovo Multimedia Headset 40Y8518</p>		
• ThinkVantage Productivity Center	<p>USB 2.0 Lenovo Webcam 40Y8519</p>		
• ThinkVantage System Update	<p>USB 2.0 Essential Memory Key 32GB 45K1258</p>		
• Norton Internet Security™ (90 days of virus definitions)	<p>USB 2.0 Security Memory Key 2GB 41U5119</p>		
• Diskeeper® Home	<p>USB 2.0 Security Memory Key 4GB 41U5120</p>		
• PC-Doctor™ (diagnostics)	<p>USB 2.0 Ultra Secure Memory Key 2GB 45J5916</p>		
• Adobe® Reader	<p>USB 2.0 Ultra Secure Memory Key 4GB 45J5917</p>		
• Windows Live™ Toolbar	<p>USB 2.0 Ultra Secure Memory Key 8GB 45J5918</p>		
• Windows Live Search	<p>USB 2.0 Portable 160GB Hard Disk 43R1784</p>		
• Picasa from Google	<p>USB 2.0 Portable Secure 320GB Hard Disk 43R2019</p>		
• Microsoft Office 2007 Trial (60-day)	<p>USB 2.0 Super Multi-Burner Drive 41N5565</p>		
• Multimedia Center for Think Offerings (DVD, DVD±RW)	<p>ThinkVision® L2440x Wide 24" Monitor 4421HB2</p>		
• Sonic RecordNow and Drive Letter Access (DVD±RW)	<p>DisplayPort to Single-link DVI-D Cable 45J7915</p>		
• Corel® WinDVD® (DVD, DVD±RW)	<p>Wireless Kbd & Opt Wheel Mouse (via USB) 73P4067</p>		
• Corel WinDVD Creator (DVD±RW)	<p>Lenovo USB Fingerprint Keyboard 73P4730</p>		
	<p>Laser Tilt Wheel Mouse (USB, PS/2) 41U3074</p>		
	<p>Kensington Cable Lock from Lenovo 73P2582</p>		
	<p>Kensington Twin Head Cable Lock 45K1620</p>		
	<p>ATI™ Radeon™ HD 3470 256MB (DP, VGA) 45K1636</p>		
	<p>Acc Guide in pdf lenovo.com/accessoriesguide</p>		
	<p>Other accessories at lenovo.com/accessories</p>		
			<p>Limited Warranty¹</p> <ul style="list-style-type: none"> ↪ 3-year parts and labor ↪ International Warranty Service⁹ ↪ Customer Replaceable Unit (CRU) parts only (with limited onsite service for selected parts³, 8 am - 5 pm, Mon - Fri coverage excluding holidays, next business day response time) ↪ Onsite service upgrade options (in eligible locations):⁷ <ul style="list-style-type: none"> • 3-year LOR 9x5, 4 hour response (ThinkPlus™ part number 41C9192) • 3-year LOR 24x7, 4 hour response (ThinkPlus part number 41C9193) • 4-year LOR 9x5, Next Business Day (ThinkPlus part number 41C9194) • 4-year LOR 9x5, 4 hour response (ThinkPlus part number 41C9195) • 4-year LOR 24x7, 4 hour response (ThinkPlus part number 41C9196) ↪ ThinkPlus services at lenovo.com/thinkplus/warranty ↪ Post warranty maintenance services available ↪ 24 hour x 7 day¹⁴ toll-free support during the warranty period¹ via 800-426-7378

See footnotes for important warranty information
US models announced October 21, 2008

Name	Type-model	Slot x bay	Processor	GHz	Cores	Memory ⁶	SATA disk	SATA optical	Graphics	Monitor connectors	DisplayPort dongle	Intel vPro	Vista preload	Global Educ	Avail date
M58	7360-AJU	2x3	Pentium E2200	2.20	2	1GB	160GB ²	DVD	GMA	VGA, DP		No	Bus32	No	Nov 08
M58	7360-ADU	2x3	Pentium E2220	2.40	2	2GB	250GB	DVD±RW	GMA	VGA, DP	DP-to-DVI-D	No	Bus32	No	Nov 08
M58	7360-AKU	2x3	Pentium E5200	2.50	2	2GB	160GB	DVD±RW	GMA	VGA, DP	DP-to-DVI-D	No	Bus32	No	Nov 08
M58	7360-ALU	2x3	Core 2 Duo E7300	2.66	2	1GB	160GB	DVD	GMA	VGA, DP		No	Bus32	No	Nov 08
M58	7360-APU	2x3	Core 2 Duo E7300	2.66	2	2GB	160GB	DVD±RW	GMA	VGA, DP	DP-to-DVI-D	No	Bus32	No	Nov 08
M58	7360-AQU	2x3	Core 2 Duo E7300	2.66	2	2GB	250GB	DVD±RW	3470	VGA, DP	DP-to-DVI-D	No	Bus32	No	Nov 08
M58	7360-ARU	2x3	Core 2 Quad Q8200	2.33	4	2GB	250GB	DVD±RW	3470	VGA, DP	DP-to-DVI-D	No	Bus32	No	Nov 08

• **These models have a 3-year limited warranty¹**

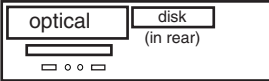
Positioning Processor	<p><i>Ultimate stability for small and medium businesses</i></p> <p>Intel® Pentium® Dual-Core Processor E2200 or E2220 with dual-core, 800MHz system bus, and 1MB L2 cache or Intel Pentium Dual-Core Processor E5200 with dual-core, 800MHz system bus, and 2MB L2 cache or Intel Core™ 2 Duo Processor E7300 with dual-core, 1066MHz system bus, and 3MB L2 cache or Intel Core 2 Quad Processor Q8200 with quad-core, 1333MHz system bus, and 4MB L2 cache</p> <p>Processor in FC-LGA6 or FC-LGA8 package in LGA775 socket</p>		<p>Small</p>  <p>Bay ① 5.25", 1.6" high, access, std optical Bay ② 3.5", 1" high, no access, std disk Bay ③ 3.5", .5" high, access, open (reader)</p> <p>Slot 1: Low Profile, PCI Express 2.0 x16* Slot 2: Low Profile, 32-bit PCI 2.3</p> <p>* used in some models</p> <ul style="list-style-type: none"> • Business black color; metal case • 12.5" W X 14.0" D X 3.9" H • 317mm W X 355mm D X 99mm H • 16.5 lb (7.5 kg) in maximum configuration • Toolless cover flips up and tilts backward on rear hinges • Toolless disk, optical drive removal • Toolless adapter retention • Toolless systemboard retention • System floor stand for vertical orientation
Memory	<p>1GB or 2GB std, 8GB max⁸, PC3-8500 1066MHz DDR3, non-parity, dual-channel capable, four 240-pin DIMM sockets; <i>Italics:</i> standard memory in two sockets; two sockets available; <i>Non-italics:</i> standard memory in one socket; 3 sockets available</p>		<p>Security</p> <ul style="list-style-type: none"> • Security chip (see information on left) • Security slot (in rear for attachment of optional Kensington® Microsaver® cable) - optional cable also locks the cover by deactivating the cover release buttons • Power-on password • Administrator password • Hard disk password (user and master) • Boot sequence control • Boot without diskette, keyboard • Serial port I/O control • Individual USB port disablement
Graphics	<p><i>Some:</i> Intel Graphics Media Accelerator 4500 (GMA 4500), integrated graphics in Q45, uses main memory (up to 253MB [1GB system mem], 765MB [2GB system mem]), one analog VGA DB-15 connector, one DisplayPort™ conn, HDCP, DirectX® 10, supports dual independent display</p> <p><i>Some:</i> ATI™ Radeon™ HD 3470, PCI Express® 2.0 x16 adapter, 256MB, one analog VGA DB-15 connector, one DisplayPort connector, HDCP, DirectX 10.1, ATI Avivo™, 25 watts</p>		
DP dongle	<p><i>Some:</i> DisplayPort to Single-link DVI-D Cable (45J7915)</p>		<p>Supports ThinkVantage® technologies</p> <p>GREENGUARD® certified RoHS-compliant</p> <p>Limited Warranty¹</p> <ul style="list-style-type: none"> ↪ 3-year parts and labor ↪ International Warranty Service⁹ ↪ Customer Replaceable Unit (CRU) parts only (with limited onsite service for selected parts³, 8 am - 5 pm, Mon - Fri coverage excluding holidays, next business day response time) ↪ Onsite service upgrade options (in eligible locations):⁷ <ul style="list-style-type: none"> • 3-year LOR 9x5, 4 hour response (ThinkPlus™ part number 41C9192) • 3-year LOR 24x7, 4 hour response (ThinkPlus part number 41C9193) • 4-year LOR 9x5, Next Business Day (ThinkPlus part number 41C9194) • 4-year LOR 9x5, 4 hour response (ThinkPlus part number 41C9195) • 4-year LOR 24x7, 4 hour response (ThinkPlus part number 41C9196) ↪ ThinkPlus services at lenovo.com/thinkplus/warranty ↪ Post warranty maintenance services available ↪ 24 hour x 7 day¹⁴ toll-free support during the warranty period¹ via 800-426-7378
SATA disk	<p>160GB or 250GB, SATA 3.0Gb/s 7200 rpm, vibration dampening mounts</p>		
SATA controller	<p>Serial ATA, SATA 3.0Gb/s, integrated in ICH10DO, RAID 0/1 support</p>		
SATA DVD	<p><i>Some:</i> DVD-ROM DL SATA 1.5Gb/s 16-48X Max⁴ Drive (41N5618)</p>		
SATA DVD±RW	<p><i>Some:</i> Super Multi-Burner DL DVD±RW SATA 1.5Gb/s Drive (41N5620)</p>		
SATA cables	<p>Two SATA cables (each 1-drop to device), two SATA connectors on planar</p>		
eSATA port	<p>One external SATA (eSATA) port</p>		
Diskette drive	<p>None</p>		
Media reader	<p>None</p>		
Chipset	<p>Intel Q45 Express Chipset (PCI Express 2.0 x16), I/O Controller Hub 10 Digital Office [ICH10DO] (SATA 3.0Gb/s with RAID 0/1 support, PCI Express x1, ethernet MAC, PCI 2.3, USB, LPC bus), SMSC® SCH5617 Super I/O</p>		
Front ports	<p>Two USB 2.0, microphone (stereo, 3.5mm), headphone (stereo, 3.5mm)</p>		
Rear ports	<p>Six USB 2.0, serial (9-pin), ethernet (RJ-45), monitor (VGA DB-15, DisplayPort), eSATA</p>		
Internal connector	<p>Two USB 2.0 planar conn (1 used; one open for media reader or 2 rear USB ports)</p>		
Rear audio ports	<p>Line-in (stereo, 3.5mm), line-out (stereo, 3.5mm), microphone-in (stereo, 3.5mm)</p>		
Audio	<p>High Definition (HD) Audio, Analog Devices AD1882 codec</p>		
Speaker	<p>One internal speaker for business audio</p>		
Ethernet	<p>Gigabit ethernet on planar, Intel 82567LM, Wake on LAN®, ASF2.0, DASH 1.0</p>		
Intel AMT	<p>None</p>		
Modem	<p>None</p>		
Security chip	<p>Winbond® WPCT200 SafeKeeper™ Trusted Platform Module, TCG 1.2-compliant</p>		
Keyboard	<p>Preferred Pro USB Keyboard (USB connector), 104-key, black, Lenovo logo</p>		
Mouse	<p>Optical Wheel Mouse (USB connector), 400 dpi, black, Lenovo logo</p>		
Power supply	<p>280 watts with variable speed fan, autosensing, two diagnostic LEDs</p>		
Preloaded operating system²⁰	<p>- Microsoft® Windows® Vista® Business Edition (32-bit) ↪ Vista Premium logo</p>		
Preloaded applications⁵ (only some listed)	<p>• Rescue and Recovery™ • Client Security Solution™ • ThinkVantage Productivity Center • ThinkVantage System Update • ThinkVantage Power Manager • Norton Internet Security™ • Diskeeper® Home • PC-Doctor™ (diagnostics) • Adobe® Reader • Picasa from Google • Microsoft Office 2007 Trial (60-day) • Sonic RecordNow and Drive Letter Access (DVD±RW) • Corel® WinDVD® (DVD, DVD±RW)</p>		
Accessories	<p>1GB PC3-8500 DDR3 UDIMM 45J5434 2GB PC3-8500 DDR3 UDIMM 45J5435 500GB SATA 3.0Gb/s Disk (7200 rpm) 43R1990 1TB SATA 3.0Gb/s Disk (7200 rpm) 45J7918 USB Portable Diskette Drive 05K9276 USB 2.0 Lenovo Multimedia Headset 40Y8518 USB 2.0 Lenovo Webcam 40Y8519 USB 2.0 Essential Memory Key 32GB 45K1258 USB 2.0 Ultra Secure Memory Key 8GB 45J5918 USB 2.0 Portable Secure 320GB Hard Disk 43R2019 USB 2.0 Super Multi-Burner Drive 41N5565 ThinkVision® L2440x Wide 24" Monitor 4421HB2 Wireless Kbd & Opt Wheel Mouse (via USB) 73P4067 Laser Tilt Wheel Mouse (USB, PS/2) 41U3074 Kensington Cable Lock from Lenovo 73P2582 Kensington Twin Head Cable Lock 45K1620 ATI Radeon HD 3470 256MB (DP, VGA) 45K1636 Acc Guide in pdf lenovo.com/accessoriesguide Other accessories at lenovo.com/accessories</p>		

See footnotes for important warranty information
 US models announced October 21, 2008

ThinkCentre® M58 Small (6258) - ENERGY STAR® 4.0

Personal Systems Reference (PSREF)

Name	Type-model	Slot x bay	Processor	GHz	Cores	Memory ⁸	SATA disk	SATA optical	Graphics	Monitor conn	DisplayPort dongle	ENERGY STAR 4.0	Intel vPro	Vista preload	Global Educ	Avail date
M58	6258-A7U	2x3	Celeron E1200	1.60	2	1GB	160GB ²	DVD	GMA	VGA, DP		ES40	No	Bus32	No	Nov 08
M58	6258-A8U	2x3	Pentium E2200	2.20	2	1GB	160GB	DVD	GMA	VGA, DP		ES40	No	Bus32	No	Nov 08
M58	6258-A9U	2x3	Pentium E5200	2.50	2	1GB	160GB	DVD±RW	GMA	VGA, DP	DP-to-DVI-D	ES40	No	Bus32	No	Nov 08
M58	6258-ABU	2x3	Core 2 Duo E7300	2.66	2	1GB	160GB	DVD	GMA	VGA, DP		ES40	No	Bus32	No	Nov 08
M58	6258-ACU	2x3	Core 2 Duo E7300	2.66	2	2GB	160GB	DVD±RW	GMA	VGA, DP	DP-to-DVI-D	ES40	No	Bus32	No	Nov 08
M58	6258-ADU	2x3	Core 2 Duo E7300	2.66	2	2GB	250GB	DVD±RW	3470	VGA, DP	DP-to-DVI-D	ES40	No	Bus32	No	Nov 08
M58	6258-AEU	2x3	Core 2 Quad Q8200	2.33	4	2GB	250GB	DVD±RW	3470	VGA, DP	DP-to-DVI-D	ES40	No	Bus32	No	Nov 08

• **These models have a 3-year limited warranty¹**

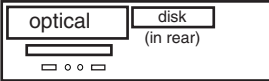
Positioning Processor	<p><i>Ultimate stability for small and medium businesses</i></p> <p>Intel® Celeron® Dual-Core Processor E1200 with dual-core, 800MHz system bus, and 512KB L2 cache or Intel Pentium® Dual-Core Processor E2200 with dual-core, 800MHz system bus, and 1MB L2 cache or Intel Pentium Dual-Core Processor E5200 with dual-core, 800MHz system bus, and 2MB L2 cache or Intel Core™ 2 Duo Processor E7300 with dual-core, 1066MHz system bus, and 3MB L2 cache or Intel Core 2 Quad Processor Q8200 with quad-core, 1333MHz system bus, and 4MB L2 cache</p> <p>Processor in FC-LGA6 or FC-LGA8 package in LGA775 socket</p>		<p>Small</p>  <p>Bay ① 5.25", 1.6" high, access, std optical Bay ② 3.5", 1" high, no access, std disk Bay ③ 3.5", .5" high, access, open (reader)</p> <p>Slot 1: Low Profile, PCI Express 2.0 x16* Slot 2: Low Profile, 32-bit PCI 2.3</p> <p>* used in some models</p> <ul style="list-style-type: none"> • Business black color; metal case • 12.5" W X 14.0" D X 3.9" H • 317mm W X 355mm D X 99mm H • 16.5 lb (7.5 kg) in maximum configuration • Toolless cover flips up and tilts backward on rear hinges • Toolless disk, optical drive removal • Toolless adapter retention • Toolless systemboard retention • System floor stand for vertical orientation
Memory	<p>1GB or 2GB std, 8GB max⁸, PC3-8500 1066MHz DDR3, non-parity, dual-channel capable, four 240-pin DIMM sockets; <i>Italics:</i> standard memory in two sockets; two sockets available; <i>Non-italics:</i> standard memory in one socket; 3 sockets available</p>		<p>Security</p> <ul style="list-style-type: none"> • Security chip (see information on left) • Security slot (in rear for attachment of optional Kensington® Microsaver® cable) - optional cable also locks the cover by deactivating the cover release buttons • Power-on password • Administrator password • Hard disk password (user and master) • Boot sequence control • Boot without diskette, keyboard • Serial port I/O control • Individual USB port disablement
Graphics	<p><i>Some:</i> Intel Graphics Media Accelerator 4500 (GMA 4500), integrated graphics in Q45, uses main memory (up to 253MB [1GB system mem], 765MB [2GB system mem]), one analog VGA DB-15 connector, one DisplayPort™ conn, HDCP, DirectX® 10, supports dual independent display</p> <p><i>Some:</i> ATI™ Radeon™ HD 3470, PCI Express® 2.0 x16 adapter, 256MB, one analog VGA DB-15 connector, one DisplayPort connector, HDCP, DirectX 10.1, ATI Avivo™, 25 watts</p>		
DP dongle	<p><i>Some:</i> DisplayPort to Single-link DVI-D Cable (45J7915)</p>		<p>Supports ThinkVantage® technologies</p> <p>Climate Savers®-compliant EPEAT™ Gold rating ENERGY STAR 4.0-compliant GREENGUARD® certified RoHS-compliant</p>
SATA disk	<p>160GB or 250GB, SATA 3.0Gb/s 7200 rpm, vibration dampening mounts</p> <p>SATA controller Serial ATA, SATA 3.0Gb/s, integrated in ICH10DO, RAID 0/1 support</p> <p>SATA DVD <i>Some:</i> DVD-ROM DL SATA 1.5Gb/s 16-48X Max⁴ Drive (41N5618)</p> <p>SATA DVD±RW <i>Some:</i> Super Multi-Burner DL DVD±RW SATA 1.5Gb/s Drive (41N5620)</p> <p>SATA cables Two SATA cables (each 1-drop to device), two SATA connectors on planar</p> <p>eSATA port One external SATA (eSATA) port</p> <p>Diskette drive None</p> <p>Media reader None</p>		
Chipset	<p>Intel Q45 Express Chipset (PCI Express 2.0 x16), I/O Controller Hub 10 Digital Office [ICH10DO] (SATA 3.0Gb/s with RAID 0/1 support, PCI Express x1, ethernet MAC, PCI 2.3, USB, LPC bus), SMSC® SCH5617 Super I/O</p>		<p>Limited Warranty¹</p> <ul style="list-style-type: none"> ↪ 3-year parts and labor ↪ International Warranty Service⁹ ↪ Customer Replaceable Unit (CRU) parts only (with limited onsite service for selected parts³, 8 am - 5 pm, Mon - Fri coverage excluding holidays, next business day response time) ↪ Onsite service upgrade options (in eligible locations):⁷ <ul style="list-style-type: none"> • 3-year LOR 9x5, 4 hour response (ThinkPlus™ part number 41C9192) • 3-year LOR 24x7, 4 hour response (ThinkPlus part number 41C9193) • 4-year LOR 9x5, Next Business Day (ThinkPlus part number 41C9194) • 4-year LOR 9x5, 4 hour response (ThinkPlus part number 41C9195) • 4-year LOR 24x7, 4 hour response (ThinkPlus part number 41C9196) ↪ ThinkPlus services at lenovo.com/thinkplus/warranty ↪ Post warranty maintenance services available ↪ 24 hour x 7 day¹⁴ toll-free support during the warranty period¹ via 800-426-7378
Front ports	<p>Two USB 2.0, microphone (stereo, 3.5mm), headphone (stereo, 3.5mm)</p>		
Rear ports	<p>Six USB 2.0, serial (9-pin), ethernet (RJ-45), monitor (VGA DB-15, DisplayPort), eSATA</p>		
Internal connector	<p>Two USB 2.0 planar conn (1 used; one open for media reader or 2 rear USB ports)</p>		
Rear audio ports	<p>Line-in (stereo, 3.5mm), line-out (stereo, 3.5mm), microphone-in (stereo, 3.5mm)</p>		
Audio	<p>High Definition (HD) Audio, Analog Devices AD1882 codec</p>		
Speaker	<p>One internal speaker for business audio</p>		
Ethernet	<p>Gigabit ethernet on planar, Intel 82567LM, Wake on LAN®, ASF2.0, DASH 1.0</p>		
Intel AMT	<p>None</p>		
Modem	<p>None</p>		
Security chip	<p>Winbond® WPCT200 SafeKeeper™ Trusted Platform Module, TCG 1.2-compliant</p>		
Keyboard	<p>Preferred Pro USB Keyboard (USB connector), 104-key, black, Lenovo logo</p>		
Mouse	<p>Optical Wheel Mouse (USB connector), 400 dpi, black, Lenovo logo</p>		
Power supply	<p>280 watts with variable speed fan, autosensing, 85% PSU</p>		
Preloaded operating system²⁰	<p>Accessories</p> <ul style="list-style-type: none"> 1GB PC3-8500 DDR3 UDIMM 45J5434 2GB PC3-8500 DDR3 UDIMM 45J5435 500GB SATA 3.0Gb/s Disk (7200 rpm) 43R1990 1TB SATA 3.0Gb/s Disk (7200 rpm) 45J7918 USB 2.0 Lenovo Multimedia Headset 40Y8518 USB 2.0 Lenovo Webcam 40Y8519 USB 2.0 Essential Memory Key 32GB 45K1258 USB 2.0 Ultra Secure Memory Key 8GB 45J5918 USB 2.0 Portable Secure 320GB Hard Disk 43R2019 USB 2.0 Super Multi-Burner Drive 41N5565 ThinkVision® L2440x Wide 24" Monitor 4421HB2 Wireless Kbd & Opt Wheel Mouse (via USB) 73P4067 Laser Tilt Wheel Mouse (USB, PS/2) 41U3074 Kensington Cable Lock from Lenovo 73P2582 ATI Radeon HD 3470 256MB (DP, VGA) 45K1636 Acc Guide in pdf lenovo.com/accessoriesguide Other accessories at lenovo.com/accessories 		
- Microsoft® Windows® Vista® Business Edition (32-bit)			
↪ Vista Premium logo			
Preloaded applications⁵ (only some listed)			
• Rescue and Recovery™			
• Client Security Solution™			
• ThinkVantage Productivity Center			
• ThinkVantage System Update			
• ThinkVantage Power Manager			
• Norton Internet Security™			
• Diskeeper® Home			
• Picasa from Google			
• Microsoft Office 2007 Trial (60-day)			
• Sonic RecordNow and Drive Letter Access (DVD±RW)			
• Corel® WinDVD® (DVD, DVD±RW)			

See footnotes for important warranty information
 US models announced October 21, 2008

Name	Type-model	Slot x bay	Processor	GHz	Cores	Memory ⁸	SATA disk	SATA optical	Graphics	Monitor connectors	DisplayPort dongle	Intel vPro	Vista preload	Global (G) GMP (P)	Avail date
M58	7638-A1U	2x3	Core 2 Duo E7300	2.66	2	1GB	160GB ²	DVD	GMA	VGA, DP	None	None	Bus32	G P	Jan 09

- This model is part of the Global Models Plus (GMP) program with limited onsite service³ 3-year limited warranty

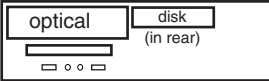
Positioning Processor	Ultimate stability for small and medium businesses Intel® Core™ 2 Duo Processor E7300 with dual-core , 1066MHz system bus, and 3MB L2 cache Processor in FC-LGA8 package in LGA775 socket										Small	
Implementation	Processor in FC-LGA8 package in LGA775 socket											
Memory	1GB std , 8GB max ⁶ , PC3-8500 1066MHz DDR3 , non-parity, dual-channel capable, four 240-pin DIMM sockets; <i>Non-italics</i> : standard memory in one socket; 3 sockets available										Bay ① 5.25", 1.6" high, access, std optical Bay ② 3.5", 1" high, no access, std disk Bay ③ 3.5", .5" high, access, open (reader)	
Graphics	Intel Graphics Media Accelerator 4500 (GMA 4500) , integrated graphics in Q45, uses main memory (up to 253MB), one analog VGA DB-15 connector, one DisplayPort™ connector (supports single-link DVI-D via cable 45J7915), HDCP, DirectX® 10, supports dual independent display										Slot 1: Low Profile, PCI Express 2.0 x16 Slot 2: Low Profile, 32-bit PCI 2.3	<ul style="list-style-type: none"> • Business black color; metal case • 12.5" W X 14.0" D X 3.9" H • 317mm W X 355mm D X 99mm H • 16.5 lb (7.5 kg) in maximum configuration • Toolless cover flips up and tilts backward on rear hinges • Toolless disk, optical drive removal • Toolless adapter retention • Toolless systemboard retention • System floor stand for vertical orientation
SATA disk	160GB , SATA 3.0Gb/s 7200 rpm, vibration dampening mounts											
SATA controller	Serial ATA, SATA 3.0Gb/s, integrated in ICH10DO, RAID 0/1											
SATA DVD	DVD-ROM DL SATA 1.5Gb/s 16-48X Max ⁴ Drive (41N5618)											
SATA cables	Two SATA cables (each 1-drop to device), two SATA connectors											
eSATA port	One external SATA (eSATA) port											
Diskette drive	None											
Media reader	None											
Chipset	Intel Q45 Express Chipset (PCI Express 2.0 x16), I/O Controller Hub 10 Digital Office [ICH10DO] (SATA 3.0Gb/s with RAID 0/1 support, PCI Express x1, ethernet MAC, PCI 2.3, USB, LPC bus), SMSC® SCH5617 Super I/O											Security
Front ports	Two USB 2.0, microphone (stereo, 3.5mm), headphone (stereo, 3.5mm)											<ul style="list-style-type: none"> • Security chip (see information on left) • Security slot (in rear for attachment of optional Kensington® Microsaver® cable) - optional cable also locks the cover by deactivating the cover release buttons • Power-on password • Administrator password • Hard disk password (user and master) • Boot sequence control • Boot without diskette, keyboard • Serial port I/O control • Individual USB port disablement
Rear ports	Six USB 2.0, serial (9-pin), ethernet (RJ-45), monitor (VGA DB-15, DisplayPort), eSATA											
Internal connector	Two USB 2.0 planar conn (1 used; one open for media reader or 2 rear USB ports)											
Rear audio ports	Line-in (stereo, 3.5mm), line-out (stereo, 3.5mm), microphone-in (stereo, 3.5mm)											
Audio	High Definition (HD) Audio, Analog Devices AD1882 codec											
Speaker	One internal speaker for business audio											
Ethernet	Gigabit ethernet on planar, Intel 82567LM, Wake on LAN®, ASF2.0, DASH 1.0											
Intel AMT	None											
Modem	None											
Security chip	Winbond® WPCT200 SafeKeeper™ Trusted Platform Module, TCG 1.2-compliant											
Keyboard	Preferred Pro USB Keyboard (USB connector), 104-key, black, Lenovo logo											
Mouse	Optical Wheel Mouse (USB connector), 400 dpi, black, Lenovo logo											
Power supply	280 watts with variable speed fan, autosensing, two diagnostic LEDs											
Preloaded operating system²⁰	Accessories											
- Microsoft® Windows® Vista® Business Edition (32-bit)	1GB PC3-8500 DDR3 UDIMM 45J5434											
◇ Vista Premium logo	2GB PC3-8500 DDR3 UDIMM 45J5435											
	500GB SATA 3.0Gb/s Disk (7200 rpm) 43R1990											
	1TB SATA 3.0Gb/s Disk (7200 rpm) 45J7918											
	USB Portable Diskette Drive 05K9276											
	USB 2.0 Lenovo Multimedia Headset 40Y8518											
	USB 2.0 Lenovo Webcam 40Y8519											
	USB 2.0 Essential Memory Key 32GB 45K1258											
	USB 2.0 Security Memory Key 2GB 41U5119											
	USB 2.0 Security Memory Key 4GB 41U5120											
	USB 2.0 Ultra Secure Memory Key 2GB 45J5916											
	USB 2.0 Ultra Secure Memory Key 4GB 45J5917											
	USB 2.0 Ultra Secure Memory Key 8GB 45J5918											
	USB 2.0 Portable 160GB Hard Disk 43R1784											
	USB 2.0 Portable Secure 320GB Hard Disk 43R2019											
	USB 2.0 Super Multi-Burner Drive 41N5565											
	ThinkVision® L2440x Wide 24" Monitor 4421HB2											
	DisplayPort to Single-link DVI-D Cable 45J7915											
	Wireless Kbd & Opt Wheel Mouse (via USB) 73P4067											
	Laser Tilt Wheel Mouse (USB, PS/2) 41U3074											
	Kensington Cable Lock from Lenovo 73P2582											
	Kensington Twin Head Cable Lock 45K1620											
	ATI™ Radeon™ HD 3470 256MB (DP, VGA) 45K1636											
	Acc Guide in pdf lenovo.com/accessoriesguide											
	Other accessories at lenovo.com/accessories											
												Supports ThinkVantage® technologies
												GREENGUARD® certified RoHS-compliant
												Limited Warranty¹
												↪ 3-year parts and labor
												↪ International Warranty Service⁹
												↪ Customer Replaceable Unit (CRU) parts only (with limited onsite service for selected parts³, 8 am - 5 pm, Mon - Fri coverage excluding holidays, next business day response time)
												↪ Onsite service upgrade options (in eligible locations):⁷
												• 4-year LOR 9x5, Next Business Day (ThinkPlus part number 41C9194)
												• 4-year LOR 9x5, 4 hour response (ThinkPlus part number 41C9195)
												• 4-year LOR 24x7, 4 hour response (ThinkPlus part number 41C9196)
												↪ ThinkPlus services at lenovo.com/thinkplus/warranty
												↪ Post warranty maintenance services available
												↪ 24 hour x 7 day¹⁴ toll-free support during the warranty period¹ via 800-426-7378

See footnotes for important warranty information
US model announced December 9, 2008

ThinkCentre® M58 Tower (9960) - TopSeller

Personal Systems Reference (PSREF)

Name	Type-model	Slot x bay	Processor	GHz	Cores	Memory ³	SATA disk	SATA optical	Graphics	Monitor connectors	DisplayPort dongle	Intel vPro	Preload	Global Educ	Avail date
M58	9960-A8U	4x4	Pentium E5200	2.50	2	1GB	160GB ²	DVD	GMA	VGA, DP	None	None	XP Pro	None	Nov 08
M58	9960-A9U	4x4	Core 2 Duo E7300	2.66	2	1GB	160GB	DVD±RW	GMA	VGA, DP	None	None	XP Pro	None	Nov 08

- These small and medium business (SMB) models are part of the US TopSeller™ Program
- These models have a 3-year limited warranty¹

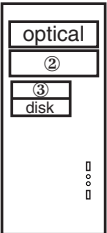
Positioning Processor	<p><i>Ultimate stability for small and medium businesses</i> Intel® Pentium® Dual-Core Processor E5200 with dual-core, 800MHz system bus, and 2MB L2 cache or Intel Core™ 2 Duo Processor E7300 with dual-core, 1066MHz system bus, and 3MB L2 cache</p>										<p>Tower</p> <ul style="list-style-type: none"> • Business black color; metal case • 6.9" W X 17.3" D X 15.8" H • 175mm W X 440mm D X 402mm H • 24.2 lb (11.0 kg) in max configuration • Handle on top front • Toolless cover removal • Toolless disk, diskette drive, optical drive removal • Toolless adapter retention 
Implementation	Processor in FC-LGA6 or FC-LGA8 package in LGA775 socket										
Memory	<p>1GB, 8GB max⁸, PC3-8500 1066MHz DDR3, non-parity, dual-channel capable, four 240-pin DIMM sockets; <i>Non-italics</i>: standard memory in one socket; 3 sockets available</p>										<p>Bay ① 5.25", 1.6" high, access, std optical Bay ② 5.25", 1.6" high, access, open Bay ③ 3.5", 1" high, access, open (reader/diskette) Bay ④ 3.5", 1" high, no access, std disk</p> <p>Slot 1: half-length, full-height, PCIe 2.0 x16 (75w max) Slot 2: half-length, full-height, PCIe x1 Slot 3: half-length, full-height, 32-bit PCI 2.3 Slot 4: half-length, full-height, 32-bit PCI 2.3</p>
Graphics	<p>Intel Graphics Media Accelerator 4500 (GMA 4500), integrated graphics in Q45, uses main memory (up to 512MB), one analog VGA DB-15 connector, one DisplayPort™ connector (supports single-link DVI-D via cable 45J7915), HDCP, DirectX® 10, supports dual independent display</p>										
SATA disk	<p>160GB, SATA 3.0Gb/s 7200 rpm, vibration dampening mounts</p>										<p>Security</p> <ul style="list-style-type: none"> • Security chip (see information on left) • One lock to secure both cover and entire system to fixed object: <ul style="list-style-type: none"> - Padlock loop (in rear for opt padlock) - Security slot (in rear for optional Kensington® Microsaver® cable) • Power-on password • Administrator password • Hard disk password (user and master) • Boot sequence control • Boot without diskette, keyboard • Serial port I/O control • Individual USB port disablement
SATA controller	Serial ATA, SATA 3.0Gb/s, integrated in ICH10DO, RAID 0/1										
SATA DVD	<p><i>Some</i>: DVD-ROM DL SATA 1.5Gb/s 16-48X Max⁴ Drive (41N5618)</p>										<p>Supports ThinkVantage® technologies</p>
SATA DVD±RW	<p><i>Some</i>: Super Multi-Burner DL DVD±RW SATA Drive (41N5620)</p>										
SATA cables	Two SATA cables (each 1-drop to device), three SATA connectors and one eSATA connector on planar										<p>GREENGUARD® certified RoHS-compliant</p>
eSATA port	None										
Diskette drive	None										<p>Limited Warranty¹</p> <ul style="list-style-type: none"> ↔ 3-year parts and labor ↔ International Warranty Service⁹ ↔ Customer Replaceable Unit (CRU) parts only (with limited onsite service for selected parts³, 8 am - 5 pm, Mon - Fri coverage excluding holidays, next business day response time) ↔ Onsite service upgrade options (in eligible locations):⁷ <ul style="list-style-type: none"> • 3-year LOR 9x5, 4 hour response (ThinkPlus™ part number 41C9192) • 3-year LOR 24x7, 4 hour response (ThinkPlus part number 41C9193) • 4-year LOR 9x5, Next Business Day (ThinkPlus part number 41C9194) • 4-year LOR 9x5, 4 hour response (ThinkPlus part number 41C9195) • 4-year LOR 24x7, 4 hour response (ThinkPlus part number 41C9196) ↔ ThinkPlus services at lenovo.com/thinkplus/warranty ↔ Post warranty maintenance services available ↔ 24 hour x 7 day¹⁴ toll-free support during the warranty period¹ via 800-426-7378
Media reader	None										
Chipset	<p>Intel Q45 Express Chipset (PCI Express® 2.0 x16), I/O Controller Hub 10 Digital Office [ICH10DO] (SATA 3.0Gb/s with RAID 0/1 support, PCI Express x1, ethernet MAC, PCI 2.3, USB, LPC bus), SMSC® SCH5617 Super I/O</p>										
Front ports	Two USB 2.0, microphone (stereo, 3.5mm), headphone (stereo, 3.5mm)										
Rear ports	Six USB 2.0, serial (9-pin), keyboard (PS/2), mouse (PS/2), ethernet (RJ-45), monitor (VGA DB-15, DisplayPort)										
Internal connector	Two USB 2.0 planar conn (1 used; one open for media reader or 2 rear USB ports)										
Rear audio ports	Line-in (stereo, 3.5mm), line-out (stereo, 3.5mm), microphone-in (stereo, 3.5mm)										
Audio	High Definition (HD) Audio, Analog Devices AD1882 codec										
Speaker	One internal speaker for business audio										
Ethernet	Gigabit ethernet on planar, Intel 82567LM, Wake on LAN®, ASF2.0, DASH 1.0										
Intel AMT	None										
Modem	None										
Security chip	Winbond® WPCT200 SafeKeeper™ Trusted Platform Module, TCG 1.2-compliant										
Keyboard	Preferred Pro USB Keyboard (USB connector), 104-key, black, Lenovo logo										
Mouse	Optical Wheel Mouse (USB connector), black, Lenovo logo										
Power supply	280 watts with variable speed fan, manual switch, two diagnostic LEDs										
Preloaded operating system²⁰	<p>- Microsoft® Windows® XP Professional with Vista® COA</p> <p>◇ Disk-to-Disk Recovery (in hidden protected area)</p> <p>◇ Vista Basic logo</p>										
Preloaded applications⁵	<ul style="list-style-type: none"> • Rescue and Recovery™ • Client Security Solution™ • ThinkVantage Productivity Center • ThinkVantage System Update • Norton Internet Security™ (90 days of virus definitions) • Diskeeper® Home • PC-Doctor™ (diagnostics) • Adobe® Reader • Windows Live™ Toolbar • Windows Live Search • Picasa from Google • Microsoft Office 2007 Trial (60-day) • Multimedia Center for Think Offerings (DVD, DVD±RW) • Sonic RecordNow and Drive Letter Access (DVD±RW) • Corel® WinDVD® (DVD, DVD±RW) • Corel WinDVD Creator (DVD±RW) 										
Accessories	<ul style="list-style-type: none"> 1GB PC3-8500 DDR3 UDIMM 45J5434 2GB PC3-8500 DDR3 UDIMM 45J5435 500GB SATA 3.0Gb/s Disk (7200 rpm) 43R1990 1TB SATA 3.0Gb/s Disk (7200 rpm) 45J7918 USB 2.0 Lenovo Multimedia Headset 40Y8518 USB 2.0 Lenovo Webcam 40Y8519 USB 2.0 Essential Memory Key 32GB 45K1258 USB 2.0 Ultra Secure Memory Key 4GB 45J5917 USB 2.0 Ultra Secure Memory Key 8GB 45J5918 USB 2.0 Portable 160GB Hard Disk 43R1784 USB 2.0 Portable Secure 320GB Hard Disk 43R2019 USB 2.0 Super Multi-Burner Drive 41N5565 Blu-ray Burner / HD-DVD Player SATA Drive 43R1958 ThinkVision® L2440x Wide 24" Monitor 4421HB2 DisplayPort to Single-link DVI-D Cable 45J7915 Wireless Kbd & Opt Wheel Mouse (via USB) 73P4067 Lenovo USB Fingerprint Keyboard 73P4730 Laser Tilt Wheel Mouse (USB, PS/2) 41U3074 Kensington Cable Lock from Lenovo 73P2582 Kensington Twin Head Cable Lock 45K1620 ATI™ Radeon™ HD 3470 256MB (DP, VGA) 45K1636 NVIDIA® GeForce® 9500GT 512MB (DP, DVI) 45K1635 NVIDIA Quadro® 256MB FX 370 43R1766 NVIDIA Quadro 512MB FX 1700 43R1767 Acc Guide in pdf lenovo.com/accessoriesguide Other accessories at lenovo.com/accessories 										

See footnotes for important warranty information
US models announced October 21, 2008

© Lenovo
(MLAN1-11) November 2008

Name	Type-model	Slot x bay	Processor	GHz	Cores	Memory ^a	SATA disk	SATA optical	Graphics	Monitor conn	DisplayPort dongle	Chassis intr switch	Intel vPro	Vista preload	Global Educ	Avail date																																				
M58	7373-AMU	4x4	Celeron E1400	2.00	2	1GB	160GB ²	DVD	GMA	VGA, DP			No	Bus32	No	Nov 08																																				
M58	7373-ACU	4x4	Pentium E2200	2.20	2	1GB	160GB	DVD	GMA	VGA, DP		Switch	No	Bus32	No	Nov 08																																				
M58	7373-AGU	4x4	Pentium E2220	2.40	2	1GB	160GB	DVD±RW	GMA	VGA, DP			No	Bus32	No	Nov 08																																				
M58	7373-ANU	4x4	Pentium E5200	2.50	2	2GB	160GB	DVD±RW	GMA	VGA, DP			No	Bus32	No	Nov 08																																				
M58	7373-ABU	4x4	Core 2 Duo E7300	2.66	2	1GB	160GB	DVD	GMA	VGA, DP			No	Bus32	No	Nov 08																																				
M58	7373-APU	4x4	Core 2 Duo E7300	2.66	2	2GB	160GB	DVD±RW	GMA	VGA, DP	DP-to-DVI-D		No	Bus32	No	Nov 08																																				
<p>• These models have a 3-year limited warranty¹</p>																																																				
Positioning Processor	<p><i>Ultimate stability for small and medium businesses</i> Intel® Celeron® Dual-Core Processor E1400 with dual-core, 800MHz system bus, and 512KB L2 cache or Intel Pentium® Dual-Core Processor E2200 or E2220 with dual-core, 800MHz system bus, and 1MB L2 cache or Intel Pentium Dual-Core Processor E5200 with dual-core, 800MHz system bus, and 2MB L2 cache or Intel Core™ 2 Duo Processor E7300 with dual-core, 1066MHz system bus, and 3MB L2 cache Processor in FC-LGA6 or FC-LGA8 package in LGA775 socket</p>										<p>Tower</p> <ul style="list-style-type: none"> • Business black color; metal case • 6.9" W X 17.3" D X 15.8" H • 175mm W X 440mm D X 402mm H • 24.2 lb (11.0 kg) in max configuration • Handle on top front • Toolless cover removal • Toolless disk, diskette drive, optical drive removal • Toolless adapter retention 																																									
Implementation	<p>Processor in FC-LGA6 or FC-LGA8 package in LGA775 socket</p>										<p>Bay ① 5.25", 1.6" high, access, std optical Bay ② 5.25", 1.6" high, access, open Bay ③ 3.5", 1" high, access, open (reader/diskette) Bay ④ 3.5", 1" high, no access, std disk</p>																																									
Memory	<p>1GB or 2GB std, 8GB max⁸, PC3-8500 1066MHz DDR3, non-parity, dual-channel capable, four 240-pin DIMM sockets; <i>Italics:</i> standard memory in two sockets; two sockets available; <i>Non-italics:</i> standard memory in one socket; 3 sockets available</p>										<p>Slot 1: half-length, full-height, PCIe 2.0 x16 (75w max) Slot 2: half-length, full-height, PCIe x1 Slot 3: half-length, full-height, 32-bit PCI 2.3 Slot 4: half-length, full-height, 32-bit PCI 2.3</p>																																									
Graphics	<p>Intel Graphics Media Accelerator 4500 (GMA 4500), integrated graphics in Q45, uses main memory (up to 253MB [1GB system mem], 765MB [2GB system mem]), one analog VGA DB-15 connector, one DisplayPort™ connector, HDCP, DirectX® 10, supports dual independent display <i>Some:</i> DisplayPort to Single-link DVI-D Cable (45J7915)</p>																																																			
DP dongle	<p><i>Some:</i> DisplayPort to Single-link DVI-D Cable (45J7915)</p>																																																			
SATA disk	<p>160GB, SATA 3.0Gb/s 7200 rpm, vibration dampening mounts</p>																																																			
SATA controller	<p>Serial ATA, SATA 3.0Gb/s, integrated in ICH10DO, RAID 0/1 support</p>																																																			
SATA DVD	<p><i>Some:</i> DVD-ROM DL SATA 1.5Gb/s 16-48X Max⁴ Drive (41N5618)</p>																																																			
SATA DVD±RW	<p><i>Some:</i> Super Multi-Burner DL DVD±RW SATA 1.5Gb/s Drive (41N5620)</p>																																																			
SATA cables	<p>Two SATA cables (each 1-drop to device), three SATA connectors and one eSATA connector on planar</p>																																																			
eSATA port	<p>None</p>																																																			
Diskette drive	<p>None</p>																																																			
Media reader	<p>None</p>																																																			
Chipset	<p>Intel Q45 Express Chipset (PCI Express® 2.0 x16), I/O Controller Hub 10 Digital Office [ICH10DO] (SATA 3.0Gb/s with RAID 0/1 support, PCI Express x1, ethernet MAC, PCI 2.3, USB, LPC bus), SMSC® SCH5617 Super I/O</p>																																																			
Front ports	<p>Two USB 2.0, microphone (stereo, 3.5mm), headphone (stereo, 3.5mm)</p>																																																			
Rear ports	<p>Six USB 2.0, serial (9-pin), keyboard (PS/2), mouse (PS/2), ethernet (RJ-45), monitor (VGA DB-15, DisplayPort)</p>																																																			
Internal connector	<p>Two USB 2.0 planar conn (1 used; one open for media reader or 2 rear USB ports)</p>																																																			
Rear audio ports	<p>Line-in (stereo, 3.5mm), line-out (stereo, 3.5mm), microphone-in (stereo, 3.5mm)</p>																																																			
Audio	<p>High Definition (HD) Audio, Analog Devices AD1882 codec</p>																																																			
Speaker	<p>One internal speaker for business audio</p>																																																			
Ethernet	<p>Gigabit ethernet on planar, Intel 82567LM, Wake on LAN®, ASF2.0, DASH 1.0</p>																																																			
Intel AMT	<p>None</p>																																																			
Modem	<p>None</p>																																																			
Security chip	<p>Winbond® WPCT200 SafeKeeper™ Trusted Platform Module, TCG 1.2-compliant</p>										<p>Security</p> <ul style="list-style-type: none"> • Security chip (see information on left) • One lock to secure both cover and entire system to fixed object: <ul style="list-style-type: none"> - Padlock loop (in rear for opt padlock) - Security slot (in rear for optional Kensington® Microsaver® cable) • Power-on password • Administrator password • Hard disk password (user and master) • Boot sequence control • Boot without diskette, keyboard • Serial port I/O control • Individual USB port disablement • <i>Some:</i> Chassis intrusion switch 																																									
Keyboard	<p>Preferred Pro USB Keyboard (USB connector), 104-key, black, Lenovo logo</p>										<p>Supports ThinkVantage® technologies</p>																																									
Mouse	<p>Optical Wheel Mouse (USB connector), black, Lenovo logo</p>										<p>GREENGUARD® certified RoHS-compliant</p>																																									
Power supply	<p>280 watts with variable speed fan, manual switch, two diagnostic LEDs</p>										<p>Limited Warranty¹</p> <ul style="list-style-type: none"> ↪ 3-year parts and labor ↪ International Warranty Service⁹ ↪ Customer Replaceable Unit (CRU) parts only (with limited onsite service for selected parts³, 8 am - 5 pm, Mon - Fri coverage excluding holidays, next business day response time) ↪ Onsite service upgrade options (in eligible locations):⁷ <ul style="list-style-type: none"> • 3-year LOR 9x5, 4 hour response (ThinkPlus™ part number 41C9192) • 3-year LOR 24x7, 4 hour response (ThinkPlus part number 41C9193) • 4-year LOR 9x5, Next Business Day (ThinkPlus part number 41C9194) • 4-year LOR 9x5, 4 hour response (ThinkPlus part number 41C9195) • 4-year LOR 24x7, 4 hour response (ThinkPlus part number 41C9196) ↪ ThinkPlus services at lenovo.com/thinkplus/warranty ↪ Post warranty maintenance services available ↪ 24 hour x 7 day¹⁴ toll-free support during the warranty period¹ via 800-426-7378 																																									
Preloaded operating system²⁰	<p>- Microsoft® Windows® Vista® Business Edition (32-bit) ↪ Vista Premium logo</p>										<p>Accessories</p> <table border="0"> <tr><td>1GB PC3-8500 DDR3 UDIMM</td><td>45J5434</td></tr> <tr><td>2GB PC3-8500 DDR3 UDIMM</td><td>45J5435</td></tr> <tr><td>500GB SATA 3.0Gb/s Disk (7200 rpm)</td><td>43R1990</td></tr> <tr><td>1TB SATA 3.0Gb/s Disk (7200 rpm)</td><td>45J7918</td></tr> <tr><td>USB 2.0 Lenovo Multimedia Headset</td><td>40Y8518</td></tr> <tr><td>USB 2.0 Lenovo Webcam</td><td>40Y8519</td></tr> <tr><td>USB 2.0 Essential Memory Key 32GB</td><td>45K1258</td></tr> <tr><td>USB 2.0 Ultra Secure Memory Key 8GB</td><td>45J5918</td></tr> <tr><td>USB 2.0 Portable Secure 320GB Hard Disk</td><td>43R2019</td></tr> <tr><td>Blu-ray Burner / HD-DVD Player SATA Drive</td><td>43R1958</td></tr> <tr><td>ThinkVision® L2440x Wide 24" Monitor</td><td>4421HB2</td></tr> <tr><td>Wireless Kbd & Opt Wheel Mouse (via USB)</td><td>73P4067</td></tr> <tr><td>Lenovo USB Fingerprint Keyboard</td><td>73P4730</td></tr> <tr><td>Laser Tilt Wheel Mouse (USB, PS/2)</td><td>41U3074</td></tr> <tr><td>Kensington Cable Lock from Lenovo</td><td>73P2582</td></tr> <tr><td>Kensington Twin Head Cable Lock</td><td>45K1620</td></tr> <tr><td>ATI™ Radeon™ HD 3470 256MB (DP, VGA)</td><td>45K1636</td></tr> <tr><td>NVIDIA® GeForce® 9500GT 512MB (DP, DVI)</td><td>45K1635</td></tr> <tr><td>NVIDIA Quadro® 256MB FX 370</td><td>43R1766</td></tr> <tr><td>NVIDIA Quadro 512MB FX 1700</td><td>43R1767</td></tr> </table> <p>Acc Guide in pdf lenovo.com/accessoriesguide Other accessories at lenovo.com/accessories</p>		1GB PC3-8500 DDR3 UDIMM	45J5434	2GB PC3-8500 DDR3 UDIMM	45J5435	500GB SATA 3.0Gb/s Disk (7200 rpm)	43R1990	1TB SATA 3.0Gb/s Disk (7200 rpm)	45J7918	USB 2.0 Lenovo Multimedia Headset	40Y8518	USB 2.0 Lenovo Webcam	40Y8519	USB 2.0 Essential Memory Key 32GB	45K1258	USB 2.0 Ultra Secure Memory Key 8GB	45J5918	USB 2.0 Portable Secure 320GB Hard Disk	43R2019	Blu-ray Burner / HD-DVD Player SATA Drive	43R1958	ThinkVision® L2440x Wide 24" Monitor	4421HB2	Wireless Kbd & Opt Wheel Mouse (via USB)	73P4067	Lenovo USB Fingerprint Keyboard	73P4730	Laser Tilt Wheel Mouse (USB, PS/2)	41U3074	Kensington Cable Lock from Lenovo	73P2582	Kensington Twin Head Cable Lock	45K1620	ATI™ Radeon™ HD 3470 256MB (DP, VGA)	45K1636	NVIDIA® GeForce® 9500GT 512MB (DP, DVI)	45K1635	NVIDIA Quadro® 256MB FX 370	43R1766	NVIDIA Quadro 512MB FX 1700	43R1767
1GB PC3-8500 DDR3 UDIMM	45J5434																																																			
2GB PC3-8500 DDR3 UDIMM	45J5435																																																			
500GB SATA 3.0Gb/s Disk (7200 rpm)	43R1990																																																			
1TB SATA 3.0Gb/s Disk (7200 rpm)	45J7918																																																			
USB 2.0 Lenovo Multimedia Headset	40Y8518																																																			
USB 2.0 Lenovo Webcam	40Y8519																																																			
USB 2.0 Essential Memory Key 32GB	45K1258																																																			
USB 2.0 Ultra Secure Memory Key 8GB	45J5918																																																			
USB 2.0 Portable Secure 320GB Hard Disk	43R2019																																																			
Blu-ray Burner / HD-DVD Player SATA Drive	43R1958																																																			
ThinkVision® L2440x Wide 24" Monitor	4421HB2																																																			
Wireless Kbd & Opt Wheel Mouse (via USB)	73P4067																																																			
Lenovo USB Fingerprint Keyboard	73P4730																																																			
Laser Tilt Wheel Mouse (USB, PS/2)	41U3074																																																			
Kensington Cable Lock from Lenovo	73P2582																																																			
Kensington Twin Head Cable Lock	45K1620																																																			
ATI™ Radeon™ HD 3470 256MB (DP, VGA)	45K1636																																																			
NVIDIA® GeForce® 9500GT 512MB (DP, DVI)	45K1635																																																			
NVIDIA Quadro® 256MB FX 370	43R1766																																																			
NVIDIA Quadro 512MB FX 1700	43R1767																																																			

See footnotes for important warranty information
 US models announced October 21, 2008

ThinkCentre® M58 Tower (6239) - ENERGY STAR® 4.0

Personal Systems Reference (PSREF)

Name	Type-model	Slot x bay	Processor	GHz	Cores	Memory ^a	SATA disk	SATA optical	Graphics	Monitor conn	DisplayPort dongle	ENERGY STAR 4.0	Intel vPro	Vista preload	Global Educ	Avail date
M58	6239-ACU	4x4	Celeron E1400	2.00	2	1GB	160GB ²	DVD	GMA	VGA, DP		ES40	No	Bus32	No	Nov 08
M58	6239-ADU	4x4	Pentium E2200	2.20	2	1GB	160GB	DVD±RW	GMA	VGA, DP		ES40	No	Bus32	No	Nov 08
M58	6239-AEU	4x4	Pentium E5200	2.50	2	1GB	160GB	DVD±RW	GMA	VGA, DP		ES40	No	Bus32	No	Nov 08
M58	6239-AFU	4x4	Core 2 Duo E7300	2.66	2	1GB	160GB	DVD±RW	GMA	VGA, DP	DP-to-DVI-D	ES40	No	Bus32	No	Nov 08

• These models have a 3-year limited warranty¹

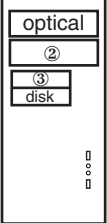
Positioning Processor	<p><i>Ultimate stability for small and medium businesses</i> Intel® Celeron® Dual-Core Processor E1400 with dual-core, 800MHz system bus, and 512KB L2 cache or Intel Pentium® Dual-Core Processor E2200 with dual-core, 800MHz system bus, and 1MB L2 cache or Intel Pentium Dual-Core Processor E5200 with dual-core, 800MHz system bus, and 2MB L2 cache or Intel Core™ 2 Duo Processor E7300 with dual-core, 1066MHz system bus, and 3MB L2 cache Processor in FC-LGA6 or FC-LGA8 package in LGA775 socket</p>										Tower	
Implementation	<p>1GB std, 8GB max⁸, PC3-8500 1066MHz DDR3, non-parity, dual-channel capable, four 240-pin DIMM sockets; <i>Non-italics:</i> standard memory in one socket; 3 sockets available</p>										<ul style="list-style-type: none"> Business black color; metal case 6.9" W X 17.3" D X 15.8" H 175mm W X 440mm D X 402mm H 24.2 lb (11.0 kg) in max configuration Handle on top front Toolless cover removal Toolless disk, diskette drive, optical drive removal Toolless adapter retention 	
Memory	<p>1GB std, 8GB max⁸, PC3-8500 1066MHz DDR3, non-parity, dual-channel capable, four 240-pin DIMM sockets; <i>Non-italics:</i> standard memory in one socket; 3 sockets available</p>										Bay ① 5.25", 1.6" high, access, std optical Bay ② 5.25", 1.6" high, access, open Bay ③ 3.5", 1" high, access, open (reader/diskette) Bay ④ 3.5", 1" high, no access, std disk	
Graphics	<p>Intel Graphics Media Accelerator 4500 (GMA 4500), integrated graphics in Q45, uses main memory (up to 253MB), one analog VGA DB-15 connector, one DisplayPort™ connector, HDCP, DirectX® 10, supports dual independent display <i>Some:</i> DisplayPort to Single-link DVI-D Cable (45J7915)</p>										Slot 1: half-length, full-height, PCIe 2.0 x16 (75w max) Slot 2: half-length, full-height, PCIe x1 Slot 3: half-length, full-height, 32-bit PCI 2.3 Slot 4: half-length, full-height, 32-bit PCI 2.3	
DP dongle	<p><i>Some:</i> DisplayPort to Single-link DVI-D Cable (45J7915)</p>											
SATA disk	<p>160GB, SATA 3.0Gb/s 7200 rpm, vibration dampening mounts</p>											
SATA controller	<p>Serial ATA, SATA 3.0Gb/s, integrated in ICH10DO, RAID 0/1</p>											
SATA DVD	<p><i>Some:</i> DVD-ROM DL SATA 1.5Gb/s 16-48X Max⁴ Drive (41N5618)</p>											
SATA DVD±RW	<p><i>Some:</i> Super Multi-Burner DL DVD±RW SATA 1.5Gb/s Drive (41N5620)</p>											
SATA cables	<p>Two SATA cables (each 1-drop to device), three SATA connectors and one eSATA connector on planar</p>											
eSATA port	<p>None</p>											
Diskette drive	<p>None</p>											
Media reader	<p>None</p>											
Chipset	<p>Intel Q45 Express Chipset (PCI Express® 2.0 x16), I/O Controller Hub 10 Digital Office [ICH10DO] (SATA 3.0Gb/s with RAID 0/1 support, PCI Express x1, ethernet MAC, PCI 2.3, USB, LPC bus), SMSC® SCH5617 Super I/O</p>											
Front ports	<p>Two USB 2.0, microphone (stereo, 3.5mm), headphone (stereo, 3.5mm)</p>											
Rear ports	<p>Six USB 2.0, serial (9-pin), keyboard (PS/2), mouse (PS/2), ethernet (RJ-45), monitor (VGA DB-15, DisplayPort)</p>											
Internal connector	<p>Two USB 2.0 planar conn (1 used; one open for media reader or 2 rear USB ports)</p>											
Rear audio ports	<p>Line-in (stereo, 3.5mm), line-out (stereo, 3.5mm), microphone-in (stereo, 3.5mm)</p>											
Audio	<p>High Definition (HD) Audio, Analog Devices AD1882 codec</p>											
Speaker	<p>One internal speaker for business audio</p>											
Ethernet	<p>Gigabit ethernet on planar, Intel 82567LM, Wake on LAN®, ASF2.0, DASH 1.0</p>											
Intel AMT	<p>None</p>											
Modem	<p>None</p>											
Security chip	<p>Winbond® WPCT200 SafeKeeper™ Trusted Platform Module, TCG 1.2-compliant</p>											
Keyboard	<p>Preferred Pro USB Keyboard (USB connector), 104-key, black, Lenovo logo</p>											
Mouse	<p>Optical Wheel Mouse (USB connector), black, Lenovo logo</p>											
Power supply	<p>280 watts with variable speed fan, autosensing, two diagnostic LEDs, 80% PSU</p>											
Preloaded operating system²⁰	<p>- Microsoft® Windows® Vista® Business Edition (32-bit) ♦ Vista Premium logo</p>											
Preloaded applications⁵	<ul style="list-style-type: none"> Rescue and Recovery™ Client Security Solution™ ThinkVantage Productivity Center ThinkVantage System Update ThinkVantage Power Manager Norton Internet Security™ (90 days of virus definitions) Diskeeper® Home PC-Doctor™ (diagnostics) Adobe® Reader Windows Live™ Toolbar Windows Live Search Picasa from Google Microsoft Office 2007 Trial (60-day) Sonic RecordNow and Drive Letter Access (DVD±RW) Corel® WinDVD® (DVD, DVD±RW) 											
Accessories	<ul style="list-style-type: none"> 1GB PC3-8500 DDR3 UDIMM 45J5434 2GB PC3-8500 DDR3 UDIMM 45J5435 500GB SATA 3.0Gb/s Disk (7200 rpm) 43R1990 1TB SATA 3.0Gb/s Disk (7200 rpm) 45J7918 USB 2.0 Lenovo Multimedia Headset 40Y8518 USB 2.0 Lenovo Webcam 40Y8519 USB 2.0 Essential Memory Key 32GB 45K1258 USB 2.0 Ultra Secure Memory Key 4GB 45J5917 USB 2.0 Ultra Secure Memory Key 8GB 45J5918 USB 2.0 Portable Secure 320GB Hard Disk 43R2019 USB 2.0 Super Multi-Burner Drive 41N5565 Blu-ray Burner / HD-DVD Player SATA Drive 43R1958 ThinkVision® L2440x Wide 24" Monitor 4421HB2 Wireless Kbd & Opt Wheel Mouse (via USB) 73P4067 Lenovo USB Fingerprint Keyboard 73P4730 Laser Tilt Wheel Mouse (USB, PS/2) 41U3074 Kensington Cable Lock from Lenovo 73P2582 Kensington Twin Head Cable Lock 45K1620 ATI™ Radeon™ HD 3470 256MB (DP, VGA) 45K1636 NVIDIA® GeForce® 9500GT 512MB (DP, DVI) 45K1635 NVIDIA Quadro® 256MB FX 370 43R1766 NVIDIA Quadro 512MB FX 1700 43R1767 Acc Guide in pdf lenovo.com/accessoriesguide Other accessories at lenovo.com/accessories 											
	<p>Security</p> <ul style="list-style-type: none"> Security chip (see information on left) One lock to secure both cover and entire system to fixed object: <ul style="list-style-type: none"> - Padlock loop (in rear for opt padlock) - Security slot (in rear for optional Kensington® Microsaver® cable) Power-on password Administrator password Hard disk password (user and master) Boot sequence control Boot without diskette, keyboard Serial port I/O control Individual USB port disablement 											
	<p>Supports ThinkVantage® technologies</p>											
	<p>EPEAT™ Gold rating ENERGY STAR 4.0-compliant GREENGUARD® certified RoHS-compliant</p>											
	<p>Limited Warranty¹</p> <ul style="list-style-type: none"> ↪ 3-year parts and labor ↪ International Warranty Service⁹ ↪ Customer Replaceable Unit (CRU) parts only (with limited onsite service for selected parts³, 8 am - 5 pm, Mon - Fri coverage excluding holidays, next business day response time) ↪ Onsite service upgrade options (in eligible locations):⁷ <ul style="list-style-type: none"> • 3-year LOR 9x5, 4 hour response (ThinkPlus™ part number 41C9192) • 3-year LOR 24x7, 4 hour response (ThinkPlus part number 41C9193) • 4-year LOR 9x5, Next Business Day (ThinkPlus part number 41C9194) • 4-year LOR 9x5, 4 hour response (ThinkPlus part number 41C9195) • 4-year LOR 24x7, 4 hour response (ThinkPlus part number 41C9196) ↪ ThinkPlus services at lenovo.com/thinkplus/warranty ↪ Post warranty maintenance services available ↪ 24 hour x 7 day¹⁴ toll-free support during the warranty period¹ via 800-426-7378 											

See footnotes for important warranty information
 US models announced October 21, 2008

Name	Type-model	Slot x bay	Processor	GHz	Cores	Memory ^a	SATA disk	SATA optical	Graphics	Monitor conn	DisplayPort dongle	ENERGY STAR 4.0	Intel vPro Preload	Global Educ	Avail date
M58p	9961-A1U	1x2	Core 2 Duo E8400	3.00	2	2GB	160GB ^b	DVD±RW	GMA	VGA, DP	None	ES40	vPro XP Pro	No	Dec 08

- Intel Core 2 Processor with vPro™ Technology (includes Intel Active Management Technology)
- This small and medium business (SMB) model is part of the US TopSeller™ Program
- This model has a 3-year limited warranty¹

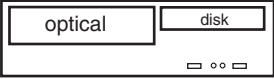
Positioning Processor	Ultimate stability/manageability for small and medium businesses Intel® Core™ 2 Duo Processor E8400 with dual-core, Virtualization Technology, TXT, 1333MHz system bus, and 6MB L2 cache										Eco Ultra Small 
Implementation	Processor in FC-LGA8 package in LGA775 socket										
Memory	2GB std , 4GB max ⁸ , PC3-8500 1066MHz DDR3 , non-parity, dual-channel capable, two 204-pin SODIMM sockets (notebook); <i>Italics:</i> standard memory in both sockets; no sockets available										Bay ① 5.25", 1.6" high, access, std optical Bay ② 3.5", 1" high, no access, std disk Slot 1: Low Profile, 32-bit PCI 2.3
Graphics	Intel Graphics Media Accelerator 4500 (GMA 4500) , integrated graphics in Q45, uses main memory (up to 1GB), one analog VGA DB-15 connector, one DisplayPort™ connector (supports single-link DVI-D via cable 45J7915), HDCP, DirectX® 10, supports dual independent display										<ul style="list-style-type: none"> • Business black color; metal case • 10.8" W X 9.4" D X 3.1" H • 275mm W X 238mm D X 80mm H • 9.2 lb (4.2 kg) in maximum configuration • Hinged toolless cover for easy serviceability • Toolless disk and optical drive removal • Toolless systemboard retention • System floor stand for vertical orientation
SATA disk	160GB , SATA 3.0Gb/s 7200 rpm, vibration dampening mounts										Security <ul style="list-style-type: none"> • Security chip (see information on left) • Security slot (in rear for attachment of optional Kensington® Microsaver® cable) - security slot and cover release button are combined into one latch for improved chassis security • Power-on password • Administrator password • Hard disk password (user and master) • Boot sequence control • Boot without diskette, keyboard • Individual USB port disablement Supports ThinkVantage® technologies
SATA controller	Serial ATA, SATA 3.0Gb/s, integrated in ICH10DO, RAID 0/1										
SATA DVD±RW	Super Multi-Burner DL DVD±RW SATA 1.5Gb/s Drive (41N5620)										
SATA cables	Two SATA cables (each 1-drop to device), two SATA connectors and one eSATA connector on planar										
eSATA port	None										EPEAT™ Gold rating ENERGY STAR® 4.0-compliant GREENGUARD® certified RoHS-compliant
Diskette drive	None										
Media reader	None										Limited Warranty¹ <ul style="list-style-type: none"> ↔ 3-year parts and labor ↔ International Warranty Service⁹ ↔ Customer Replaceable Unit (CRU) parts only (with limited onsite service for selected parts³, 8 am - 5 pm, Mon - Fri coverage excluding holidays, next business day response time) ↔ Onsite service upgrade options (in eligible locations):⁷ <ul style="list-style-type: none"> • 3-year LOR 9x5, 4 hour response (ThinkPlus™ part number 41C9192) • 3-year LOR 24x7, 4 hour response (ThinkPlus part number 41C9193) • 4-year LOR 9x5, Next Business Day (ThinkPlus part number 41C9194) • 4-year LOR 9x5, 4 hour response (ThinkPlus part number 41C9195) • 4-year LOR 24x7, 4 hour response (ThinkPlus part number 41C9196) ↔ ThinkPlus services at lenovo.com/thinkplus/warranty ↔ Post warranty maintenance services available ↔ 24 hour x 7 day¹⁴ toll-free support during the warranty period¹ via 800-426-7378
Chipset	Intel Q45 Express Chipset (PCI Express® 2.0 x16), I/O Controller Hub 10 Digital Office [ICH10DO] (SATA 3.0Gb/s with RAID 0/1 support, PCI Express x1, ethernet MAC, PCI 2.3, USB, LPC bus), SMSC® SCH5617 Super I/O										
Front ports	Two USB 2.0, microphone (stereo, 3.5mm), headphone (stereo, 3.5mm)										
Rear ports	Six USB 2.0, ethernet (RJ-45), monitor (VGA DB-15, DisplayPort)										
Internal connector	Two USB 2.0 planar conn (1 used; one open for media reader or 2 rear USB ports)										
Rear audio ports	Line-in (stereo, 3.5mm), line-out (stereo, 3.5mm), microphone (stereo, 3.5mm)										
Audio	High Definition (HD) Audio, Analog Devices AD1882 codec										
Speaker	One internal speaker for business audio										
Ethernet	Gigabit ethernet on planar, Intel 82567LM, Wake on LAN®, ASF2.0, DASH 1.0										
Intel AMT	Intel Active Management Technology (iAMT)										
Modem	None										
Security chip	Winbond® WPCT200 SafeKeeper™ Trusted Platform Module, TCG 1.2-compliant										
Keyboard	Preferred Pro USB Keyboard (USB connector), 104-key, black, Lenovo logo										
Mouse	Optical Wheel Mouse (USB connector), 400 dpi, black, Lenovo logo										
Power supply	External AC/DC adapter, 130 watts, autosensing, 87% PSU										
Preloaded operating system²⁰	<ul style="list-style-type: none"> - Microsoft® Windows® XP Professional with Vista® COA ↔ Disk-to-Disk Recovery (in hidden protected area) ↔ Vista Basic logo 										
Preloaded applications⁵	<ul style="list-style-type: none"> • Rescue and Recovery™ • Client Security Solution™ • ThinkVantage Productivity Center • ThinkVantage System Update • Norton Internet Security™ (90 days of virus definitions) • Diskeeper® Home • PC-Doctor™ (diagnostics) • Adobe® Reader • Windows Live™ Toolbar • Windows Live Search • Picasa from Google • Microsoft Office 2007 Trial (60-day) • Multimedia Center for Think Offerings (DVD±RW) • Sonic RecordNow and Drive Letter Access (DVD±RW) • Corel® WinDVD® (DVD±RW) • Corel WinDVD Creator (DVD±RW) 										
Accessories	<ul style="list-style-type: none"> 1GB PC3-8500 DDR3 SODIMM (notebook) 43R1987 2GB PC3-8500 DDR3 SODIMM (notebook) 43R1988 500GB SATA 3.0Gb/s Disk (7200 rpm) 43R1990 1TB SATA 3.0Gb/s Disk (7200 rpm) 45J7918 USB Portable Diskette Drive 05K9276 USB 2.0 Lenovo Multimedia Headset 40Y8518 USB 2.0 Lenovo Webcam 40Y8519 USB 2.0 Essential Memory Key 32GB 45K1258 USB 2.0 Ultra Secure Memory Key 2GB 45J5916 USB 2.0 Ultra Secure Memory Key 4GB 45J5917 USB 2.0 Ultra Secure Memory Key 8GB 45J5918 USB 2.0 Portable 160GB Hard Disk 43R1784 USB 2.0 Portable Secure 320GB Hard Disk 43R2019 USB 2.0 Super Multi-Burner Drive 41N5565 ThinkVision® L2440x Wide 24" Monitor 4421HB2 DisplayPort to Single-link DVI-D Cable 45J7915 ThinkCentre Ultra Small Under Desk Mount 40Y8625 Wireless Kbd & Opt Wheel Mouse (via USB) 73P4067 Lenovo USB Fingerprint Keyboard 73P4730 Laser Tilt Wheel Mouse (USB, PS/2) 41U3074 Kensington Cable Lock from Lenovo 73P2582 Kensington Twin Head Cable Lock 45K1620 Acc Guide in pdf lenovo.com/accessoriesguide Other accessories at lenovo.com/accessories 										

See footnotes for important warranty information
US model announced November 11, 2008

ThinkCentre® M58p Eco Ultra Small (7479)

Personal Systems Reference (PSREF)

Name	Type-model	Slot x bay	Processor	GHz	Cores	Memory ⁸	SATA disk	SATA optical	Graphics	Monitor conn	DisplayPort dongle	ENERGY STAR 4.0	Intel vPro	Vista preload	Global Educ	Avail date
M58p	7479-A4U	1x2	Core 2 Duo E8400	3.00	2	1GB	160GB ²	DVD	GMA	VGA, DP		ES40	vPro	Bus32	No	Dec 08
M58p	7479-A3U	1x2	Core 2 Duo E8400	3.00	2	1GB	250GB	DVD±RW	GMA	VGA, DP		ES40	vPro	Bus32	No	Dec 08
M58p	7479-A6U	1x2	Core 2 Duo E8400	3.00	2	2GB	160GB	DVD±RW	GMA	VGA, DP		ES40	vPro	Bus32	No	Dec 08
M58p	7479-A8U	1x2	Core 2 Duo E8400	3.00	2	2GB	160GB	DVD±RW	GMA	VGA, DP	DP-to-DVI-D	ES40	vPro	Bus32	No	Dec 08
M58p	7479-A9U	1x2	Core 2 Duo E8500	3.16	2	1GB	160GB	DVD	GMA	VGA, DP		ES40	vPro	Bus32	No	Dec 08
M58p	7479-ABU	1x2	Core 2 Duo E8500	3.16	2	2GB	160GB	DVD±RW	GMA	VGA, DP		ES40	vPro	Bus32	No	Dec 08
M58p	7479-ACU	1x2	Core 2 Duo E8500	3.16	2	2GB	250GB	DVD±RW	GMA	VGA, DP	DP-to-DVI-D	ES40	vPro	Bus32	No	Dec 08

- **Intel Core 2 Processor with vPro™ Technology (includes Intel Active Management Technology)**
- **These models have a 3-year limited warranty¹**

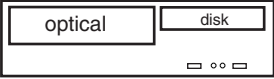
Positioning Processor	<i>Ultimate stability/manageability for large enterprise and mid-market</i> Intel® Core™ 2 Duo Processor E8400 or E8500 with dual-core, Virtualization Technology, TXT, 1333MHz system bus, and 6MB L2 cache		Eco Ultra Small	
Implementation	Processor in FC-LGA8 package in LGA775 socket			
Memory	1GB or 2GB std, 4GB max ⁸ , PC3-8500 1066MHz DDR3 , non-parity, dual-channel capable, two 204-pin SODIMM sockets (notebook); <i>Italics:</i> standard memory in both sockets; no sockets available; <i>Non-italics:</i> standard memory in one socket; one socket available		Bay ① 5.25", 1.6" high, access, std optical Bay ② 3.5", 1" high, no access, std disk	Slot 1: Low Profile, 32-bit PCI 2.3
Graphics	Intel Graphics Media Accelerator 4500 (GMA 4500), integrated graphics in Q45, uses main memory (up to 253MB [1GB system mem], 765MB [2GB system mem]), one analog VGA DB-15 connector, one DisplayPort™ connector, HDCP, DirectX® 10, supports dual independent display <i>Some:</i> DisplayPort to Single-link DVI-D Cable (45J7915)		<ul style="list-style-type: none"> • Business black color; metal case • 10.8" W X 9.4" D X 3.1" H • 275mm W X 238mm D X 80mm H • 9.2 lb (4.2 kg) in maximum configuration • Hinged toolless cover for easy serviceability • Toolless disk and optical drive removal • Toolless systemboard retention • System floor stand for vertical orientation 	
DP dongle				
SATA disk	160GB or 250GB, SATA 3.0Gb/s 7200 rpm, vibration dampening		<p style="text-align: center;">Security</p> <ul style="list-style-type: none"> • Security chip (see information on left) • Security slot (in rear for attachment of optional Kensington® Microsaver® cable) - security slot and cover release button are combined into one latch for improved chassis security • Power-on password • Administrator password • Hard disk password (user and master) • Boot sequence control • Boot without diskette, keyboard • Individual USB port disablement <p>Supports ThinkVantage® technologies</p> <p>EPEAT™ Gold rating ENERGY STAR® 4.0-compliant GREENGUARD® certified RoHS-compliant</p> <p style="text-align: center;">Limited Warranty¹</p> <ul style="list-style-type: none"> ↪ 3-year parts and labor ↪ International Warranty Service⁹ ↪ Customer Replaceable Unit (CRU) parts only (with limited onsite service for selected parts³, 8 am - 5 pm, Mon - Fri coverage excluding holidays, next business day response time) ↪ Onsite service upgrade options (in eligible locations):⁷ <ul style="list-style-type: none"> • 3-year LOR 9x5, 4 hour response (ThinkPlus™ part number 41C9192) • 3-year LOR 24x7, 4 hour response (ThinkPlus part number 41C9193) • 4-year LOR 9x5, Next Business Day (ThinkPlus part number 41C9194) • 4-year LOR 9x5, 4 hour response (ThinkPlus part number 41C9195) • 4-year LOR 24x7, 4 hour response (ThinkPlus part number 41C9196) ↪ ThinkPlus services at lenovo.com/thinkplus/warranty ↪ Post warranty maintenance services available ↪ 24 hour x 7 day¹⁴ toll-free support during the warranty period¹ via 800-426-7378 	
SATA controller	Serial ATA, SATA 3.0Gb/s, integrated in ICH10DO, RAID 0/1 support <i>Some:</i> DVD-ROM DL SATA 1.5Gb/s 16-48X Max ⁴ Drive (41N5618)			
SATA DVD	<i>Some:</i> Super Multi-Burner DL DVD±RW SATA 1.5Gb/s Drive (41N5620)			
SATA DVD±RW	Two SATA cables (each 1-drop to device), two SATA connectors and one eSATA connector on planar			
SATA cables	None			
eSATA port	None			
Diskette drive	None			
Media reader	None			
Chipset	Intel Q45 Express Chipset (PCI Express® 2.0 x16), I/O Controller Hub 10 Digital Office [ICH10DO] (SATA 3.0Gb/s with RAID 0/1 support, PCI Express x1, ethernet MAC, PCI 2.3, USB, LPC bus), SMSC® SCH5617 Super I/O			
Front ports	Two USB 2.0, microphone (stereo, 3.5mm), headphone (stereo, 3.5mm)			
Rear ports	Six USB 2.0, ethernet (RJ-45), monitor (VGA DB-15, DisplayPort)			
Internal connector	Two USB 2.0 planar conn (1 used; one open for media reader or 2 rear USB ports)			
Rear audio ports	Line-in (stereo, 3.5mm), line-out (stereo, 3.5mm), microphone (stereo, 3.5mm)			
Audio	High Definition (HD) Audio, Analog Devices AD1882 codec			
Speaker	One internal speaker for business audio			
Ethernet	Gigabit ethernet on planar, Intel 82567LM, Wake on LAN®, ASF2.0, DASH 1.0			
Intel AMT	Intel Active Management Technology (iAMT)			
Modem	None			
Security chip	Winbond® WPCT200 SafeKeeper™ Trusted Platform Module, TCG 1.2-compliant			
Keyboard	Preferred Pro USB Keyboard (USB connector), 104-key, black, Lenovo logo			
Mouse	Optical Wheel Mouse (USB connector), 400 dpi, black, Lenovo logo			
Power supply	External AC/DC adapter, 130 watts, autosensing, 87% PSU			
Preloaded operating system²⁰	Accessories			
- Microsoft® Windows® Vista® Business Edition (32-bit)	1GB PC3-8500 DDR3 SODIMM (notebook) 43R1987			
◇ Vista Premium logo	2GB PC3-8500 DDR3 SODIMM (notebook) 43R1988			
Preloaded applications⁵	500GB SATA 3.0Gb/s Disk (7200 rpm) 43R1990			
• Rescue and Recovery™	1TB SATA 3.0Gb/s Disk (7200 rpm) 45J7918			
• Client Security Solution™	USB Portable Diskette Drive 05K9276			
• ThinkVantage Productivity Center	USB 2.0 Lenovo Multimedia Headset 40Y8518			
• ThinkVantage System Update	USB 2.0 Lenovo Webcam 40Y8519			
• ThinkVantage Power Manager	USB 2.0 Essential Memory Key 32GB 45K1258			
• Norton Internet Security™ (90 days of virus definitions)	USB 2.0 Ultra Secure Memory Key 2GB 45J5916			
• Diskeeper® Home	USB 2.0 Ultra Secure Memory Key 4GB 45J5917			
• PC-Doctor™ (diagnostics)	USB 2.0 Ultra Secure Memory Key 8GB 45J5918			
• Adobe® Reader	USB 2.0 Portable 160GB Hard Disk 43R1784			
• Windows Live™ Toolbar	USB 2.0 Portable Secure 320GB Hard Disk 43R2019			
• Windows Live Search	USB 2.0 Super Multi-Burner Drive 41N5565			
• Picasa from Google	ThinkVision® L2440x Wide 24" Monitor 4421HB2			
• Microsoft Office 2007 Trial (60-day)	ThinkCentre Ultra Small Under Desk Mount 40Y8625			
• Sonic RecordNow and Drive Letter Access (DVD±RW)	Wireless Kbd & Opt Wheel Mouse (via USB) 73P4067			
• Corel® WinDVD® (DVD, DVD±RW)	Lenovo USB Fingerprint Keyboard 73P4730			
	Laser Tilt Wheel Mouse (USB, PS/2) 41U3074			
	Kensington Cable Lock from Lenovo 73P2582			
	Kensington Twin Head Cable Lock 45K1620			
	Acc Guide in pdf lenovo.com/accessoriesguide			
	Other accessories at lenovo.com/accessories			

See footnotes for important warranty information
US models announced November 11, 2008

Name	Type-model	Slot x bay	Processor	GHz	Cores	Memory ^a	SATA disk	SATA optical	Graphics	Monitor conn	DisplayPort dongle	ENERGY STAR 4.0	Intel vPro	Vista preload	Global (G) GMP (P)	Avail date
M58p	6136-A1U	1x2	Core 2 Duo E8400	3.00	2	2GB	160GB ^b	DVD±RW	GMA	VGA, DP	None	ES40	vPro	Bus32	G P	Dec 08

- Intel Core 2 Processor with vPro™ Technology (includes Intel Active Management Technology)
- This model is part of the Global Models Plus (GMP) program with limited onsite service³ 3-year limited warranty

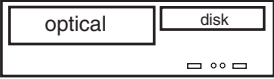
Positioning Processor	<i>Ultimate stability/manageability for large enterprise and mid-market</i> Intel® Core™ 2 Duo Processor E8400 with dual-core, Virtualization Technology, TXT, 1333MHz system bus, and 6MB L2 cache		Eco Ultra Small	
Implementation	Processor in FC-LGA8 package in LGA775 socket			
Memory	2GB std , 4GB max ⁸ , PC3-8500 1066MHz DDR3 , non-parity, dual-channel capable, two 204-pin SODIMM sockets (notebook); <i>Non-italics</i> : standard memory in one socket; one socket available		Bay ① 5.25", 1.6" high, access, std optical Bay ② 3.5", 1" high, no access, std disk Slot 1: Low Profile, 32-bit PCI 2.3	<ul style="list-style-type: none"> • Business black color; metal case • 10.8" W X 9.4" D X 3.1" H • 275mm W X 238mm D X 80mm H • 9.2 lb (4.2 kg) in maximum configuration • Hinged toolless cover for easy serviceability • Toolless disk and optical drive removal • Toolless systemboard retention • System floor stand for vertical orientation
Graphics	Intel Graphics Media Accelerator 4500 (GMA 4500) , integrated graphics in Q45, uses main memory (up to 765MB), one analog VGA DB-15 connector, one DisplayPort™ connector (supports single-link DVI-D via cable 45J7915), HDCP, DirectX® 10, supports dual independent display			
SATA disk	160GB , SATA 3.0Gb/s 7200 rpm, vibration dampening mounts		<p align="center">Security</p> <ul style="list-style-type: none"> • Security chip (see information on left) • Security slot (in rear for attachment of optional Kensington® Microsaver® cable) - security slot and cover release button are combined into one latch for improved chassis security • Power-on password • Administrator password • Hard disk password (user and master) • Boot sequence control • Boot without diskette, keyboard • Individual USB port disablement • Chassis intrusion switch 	
SATA controller	Serial ATA, SATA 3.0Gb/s, integrated in ICH10DO, RAID 0/1			
SATA DVD±RW	Super Multi-Burner DL DVD±RW SATA 1.5Gb/s Drive (41N5620)			
SATA cables	Two SATA cables (each 1-drop to device), two SATA connectors and one eSATA connector on planar			
eSATA port	None			
Diskette drive	None			
Media reader	None			
Chipset	Intel Q45 Express Chipset (PCI Express® 2.0 x16), I/O Controller Hub 10 Digital Office [ICH10DO] (SATA 3.0Gb/s with RAID 0/1 support, PCI Express x1, ethernet MAC, PCI 2.3, USB, LPC bus), SMSC® SCH5617 Super I/O			
Front ports	Two USB 2.0, microphone (stereo, 3.5mm), headphone (stereo, 3.5mm)			
Rear ports	Six USB 2.0, ethernet (RJ-45), monitor (VGA DB-15, DisplayPort)			
Internal connector	Two USB 2.0 planar conn (1 used; one open for media reader or 2 rear USB ports)			
Rear audio ports	Line-in (stereo, 3.5mm), line-out (stereo, 3.5mm), microphone (stereo, 3.5mm)			
Audio	High Definition (HD) Audio, Analog Devices AD1882 codec			
Speaker	One internal speaker for business audio			
Ethernet	Gigabit ethernet on planar, Intel 82567LM, Wake on LAN®, ASF2.0, DASH 1.0			
Intel AMT	Intel Active Management Technology (iAMT)			
Modem	None			
Security chip	Winbond® WPCT200 SafeKeeper™ Trusted Platform Module, TCG 1.2-compliant			
Keyboard	Preferred Pro USB Keyboard (USB connector), 104-key, black, Lenovo logo		Supports ThinkVantage® technologies	
Mouse	Optical Wheel Mouse (USB connector), 400 dpi, black, Lenovo logo			
Power supply	External AC/DC adapter, 130 watts, autosensing, 87% PSU			
Preloaded operating system²⁰	- Microsoft® Windows® Vista® Business Edition (32-bit) ♦ Vista Premium logo		EPEAT™ Gold rating ENERGY STAR® 4.0-compliant GREENGUARD® certified RoHS-compliant	
Preloaded applications⁵	<ul style="list-style-type: none"> • Rescue and Recovery™ • Client Security Solution™ • ThinkVantage Productivity Center • ThinkVantage System Update • ThinkVantage Power Manager • Norton Internet Security™ (90 days of virus definitions) • Diskeeper® Home • PC-Doctor™ (diagnostics) • Adobe® Reader • Windows Live™ Toolbar • Windows Live Search • Picasa from Google • Microsoft Office 2007 Trial (60-day) • Sonic RecordNow and Drive Letter Access (DVD±RW) • Corel® WinDVD® (DVD±RW) 			
Accessories	1GB PC3-8500 DDR3 SODIMM (notebook) 43R1987 2GB PC3-8500 DDR3 SODIMM (notebook) 43R1988 500GB SATA 3.0Gb/s Disk (7200 rpm) 43R1990 1TB SATA 3.0Gb/s Disk (7200 rpm) 45J7918 USB Portable Diskette Drive 05K9276 USB 2.0 Lenovo Multimedia Headset 40Y8518 USB 2.0 Lenovo Webcam 40Y8519 USB 2.0 Essential Memory Key 32GB 45K1258 USB 2.0 Ultra Secure Memory Key 2GB 45J5916 USB 2.0 Ultra Secure Memory Key 4GB 45J5917 USB 2.0 Ultra Secure Memory Key 8GB 45J5918 USB 2.0 Portable 160GB Hard Disk 43R1784 USB 2.0 Portable Secure 320GB Hard Disk 43R2019 USB 2.0 Super Multi-Burner Drive 41N5565 ThinkVision® L2440x Wide 24" Monitor 4421HB2 DisplayPort to Single-link DVI-D Cable 45J7915 ThinkCentre Ultra Small Under Desk Mount 40Y8625 Wireless Kbd & Opt Wheel Mouse (via USB) 73P4067 Lenovo USB Fingerprint Keyboard 73P4730 Laser Tilt Wheel Mouse (USB, PS/2) 41U3074 Kensington Cable Lock from Lenovo 73P2582 Kensington Twin Head Cable Lock 45K1620 Acc Guide in pdf lenovo.com/accessoriesguide Other accessories at lenovo.com/accessories		<p align="center">Limited Warranty¹</p> <ul style="list-style-type: none"> ↔ 3-year parts and labor ↔ International Warranty Service⁹ ↔ Customer Replaceable Unit (CRU) parts only (with limited onsite service for selected parts³, 8 am - 5 pm, Mon - Fri coverage excluding holidays, next business day response time) ↔ Onsite service upgrade options (in eligible locations):⁷ <ul style="list-style-type: none"> • 4-year LOR 9x5, Next Business Day (ThinkPlus part number 41C9194) • 4-year LOR 9x5, 4 hour response (ThinkPlus part number 41C9195) • 4-year LOR 24x7, 4 hour response (ThinkPlus part number 41C9196) ↔ ThinkPlus services at lenovo.com/thinkplus/warranty ↔ Post warranty maintenance services available ↔ 24 hour x 7 day¹⁴ toll-free support during the warranty period¹ via 800-426-7378 	

See footnotes for important warranty information
 US model announced November 11, 2008

ThinkCentre® M58p Small (9964) - TopSeller

Personal Systems Reference (PSREF)

Name	Type-model	Slot x bay	Processor	GHz	Cores	Memory ⁸	SATA disk	SATA optical	Graphics	Monitor connectors	DisplayPort dongle	Intel vPro	Preload	Global Educ	Avail date
M58p	9964-A1U	2x3	Core 2 Duo E8400	3.00	2	2GB	160GB ²	DVD±RW	GMA	VGA, DP	None	vPro	XP Pro	None	Nov 08
M58p	9964-A2U	2x3	Core 2 Quad Q9400	2.66	4	2GB	250GB	DVD±RW	GMA	VGA, DP	None	vPro	XP Pro	None	Nov 08

- **Intel Core 2 Processor with vPro™ Technology (includes Intel Active Management Technology)**
- **These small and medium business (SMB) models are part of the US TopSeller™ Program**
- **These models have a 3-year limited warranty¹**

Positioning Processor	<p><i>Ultimate stability/manageability for small and medium businesses</i></p> <p>Intel® Core™ 2 Duo Processor E8400 with dual-core, Virtualization Technology, TXT, 1333MHz system bus, and 6MB L2 cache or</p> <p>Intel Core 2 Quad Processor Q9400 with quad-core, Virtualization Technology, TXT, 1333MHz system bus, and 6MB L2 cache</p>		<p>Small</p> 
Implementation	Processor in FC-LGA8 package in LGA775 socket		
Memory	<p>2GB std, 8GB max⁸, PC3-8500 1066MHz DDR3, non-parity, dual-channel capable, four 240-pin DIMM sockets;</p> <p><i>Italics:</i> standard memory in two sockets; two sockets available</p>		<p>Bay ① 5.25", 1.6" high, access, std optical</p> <p>Bay ② 3.5", 1" high, no access, std disk</p> <p>Bay ③ 3.5", .5" high, access, open (reader)</p> <p>Slot 1: Low Profile, PCI Express 2.0 x16</p> <p>Slot 2: Low Profile, 32-bit PCI 2.3</p> <ul style="list-style-type: none"> • Business black color; metal case • 12.5" W X 14.0" D X 3.9" H • 317mm W X 355mm D X 99mm H • 16.5 lb (7.5 kg) in maximum configuration • Toolless cover flips up and tilts backward on rear hinges • Toolless disk, optical drive removal • Toolless adapter retention • Toolless systemboard retention • System floor stand for vertical orientation
Graphics	<p>Intel Graphics Media Accelerator 4500 (GMA 4500), integrated graphics in Q45, uses main memory (up to 1GB), one analog VGA DB-15 connector, one DisplayPort™ connector (supports single-link DVI-D via cable 45J7915), HDCP, DirectX® 10, supports dual independent display</p>		<p>Security</p> <ul style="list-style-type: none"> • Security chip (see information on left) • Security slot (in rear for attachment of optional Kensington® Microsaver® cable) - optional cable also locks the cover by deactivating the cover release buttons • Power-on password • Administrator password • Hard disk password (user and master) • Boot sequence control • Boot without diskette, keyboard • Serial port I/O control • Individual USB port disablement <p>Supports ThinkVantage® technologies</p> <p>GREENGUARD® certified RoHS-compliant</p> <p>Limited Warranty¹</p> <ul style="list-style-type: none"> ↔ 3-year parts and labor ↔ International Warranty Service⁹ ↔ Customer Replaceable Unit (CRU) parts only (with limited onsite service for selected parts³, 8 am - 5 pm, Mon - Fri coverage excluding holidays, next business day response time) ↔ Onsite service upgrade options (in eligible locations):⁷ <ul style="list-style-type: none"> • 3-year LOR 9x5, 4 hour response (ThinkPlus™ part number 41C9192) • 3-year LOR 24x7, 4 hour response (ThinkPlus part number 41C9193) • 4-year LOR 9x5, Next Business Day (ThinkPlus part number 41C9194) • 4-year LOR 9x5, 4 hour response (ThinkPlus part number 41C9195) • 4-year LOR 24x7, 4 hour response (ThinkPlus part number 41C9196) ↔ ThinkPlus services at lenovo.com/thinkplus/warranty ↔ Post warranty maintenance services available ↔ 24 hour x 7 day¹⁴ toll-free support during the warranty period¹ via 800-426-7378
SATA disk	<p>160GB or 250GB, SATA 3.0Gb/s 7200 rpm, vibration dampening</p>		
SATA controller	Serial ATA, SATA 3.0Gb/s, integrated in ICH10DO, RAID 0/1		
SATA DVD±RW	Super Multi-Burner DL DVD±RW SATA 1.5Gb/s Drive (41N5620)		
SATA cables	Two SATA cables (each 1-drop to device), two SATA connectors on planar		
eSATA port	One external SATA (eSATA) port		
Diskette drive	None		
Media reader	None		
Chipset	<p>Intel Q45 Express Chipset (PCI Express® 2.0 x16), I/O Controller Hub 10 Digital Office [ICH10DO] (SATA 3.0Gb/s with RAID 0/1 support, PCI Express x1, ethernet MAC, PCI 2.3, USB, LPC bus), SMSC® SCH5617 Super I/O</p>		
Front ports	Two USB 2.0, microphone (stereo, 3.5mm), headphone (stereo, 3.5mm)		
Rear ports	Six USB 2.0, serial (9-pin), ethernet (RJ-45), monitor (VGA DB-15, DisplayPort), eSATA		
Internal connector	Two USB 2.0 planar conn (1 used; one open for media reader or 2 rear USB ports)		
Rear audio ports	Line-in (stereo, 3.5mm), line-out (stereo, 3.5mm), microphone-in (stereo, 3.5mm)		
Audio	High Definition (HD) Audio, Analog Devices AD1882 codec		
Speaker	One internal speaker for business audio		
Ethernet	Gigabit ethernet on planar, Intel 82567LM, Wake on LAN®, ASF2.0, DASH 1.0		
Intel AMT	Intel Active Management Technology (iAMT)		
Modem	None		
Security chip	Winbond® WPCT200 SafeKeeper™ Trusted Platform Module, TCG 1.2-compliant		
Keyboard	Preferred Pro USB Keyboard (USB connector), 104-key, black, Lenovo logo		
Mouse	Optical Wheel Mouse (USB connector), 400 dpi, black, Lenovo logo		
Power supply	280 watts with variable speed fan, autosenensing, two diagnostic LEDs		
Preloaded operating system²⁰	<p>- Microsoft® Windows® XP Professional with Vista® COA</p> <p>↔ Disk-to-Disk Recovery (in hidden protected area)</p> <p>↔ Vista Basic logo</p>		
Preloaded applications⁵	<ul style="list-style-type: none"> • Rescue and Recovery™ • Client Security Solution™ • ThinkVantage Productivity Center • ThinkVantage System Update • Norton Internet Security™ (90 days of virus definitions) • Diskeeper® Home • PC-Doctor™ (diagnostics) • Adobe® Reader • Windows Live™ Toolbar • Windows Live Search • Picasa from Google • Microsoft Office 2007 Trial (60-day) • Multimedia Center for Think Offerings (DVD±RW) • Sonic RecordNow and Drive Letter Access (DVD±RW) • Corel® WinDVD® (DVD±RW) • Corel WinDVD Creator (DVD±RW) 		
Accessories	<ul style="list-style-type: none"> 1GB PC3-8500 DDR3 UDIMM 45J5434 2GB PC3-8500 DDR3 UDIMM 45J5435 500GB SATA 3.0Gb/s Disk (7200 rpm) 43R1990 1TB SATA 3.0Gb/s Disk (7200 rpm) 45J7918 USB Portable Diskette Drive 05K9276 USB 2.0 Lenovo Multimedia Headset 40Y8518 USB 2.0 Lenovo Webcam 40Y8519 USB 2.0 Essential Memory Key 32GB 45K1258 USB 2.0 Security Memory Key 2GB 41U5119 USB 2.0 Security Memory Key 4GB 41U5120 USB 2.0 Ultra Secure Memory Key 2GB 45J5916 USB 2.0 Ultra Secure Memory Key 4GB 45J5917 USB 2.0 Ultra Secure Memory Key 8GB 45J5918 USB 2.0 Portable 160GB Hard Disk 43R1784 USB 2.0 Portable Secure 320GB Hard Disk 43R2019 USB 2.0 Super Multi-Burner Drive 41N5565 ThinkVision® L2440x Wide 24" Monitor 4421HB2 DisplayPort to Single-link DVI-D Cable 45J7915 Wireless Kbd & Opt Wheel Mouse (via USB) 73P4067 Lenovo USB Fingerprint Keyboard 73P4730 Laser Tilt Wheel Mouse (USB, PS/2) 41U3074 Kensington Cable Lock from Lenovo 73P2582 Kensington Twin Head Cable Lock 45K1620 ATI™ Radeon™ HD 3470 256MB (DP, VGA) 45K1636 Acc Guide in pdf lenovo.com/accessoriesguide Other accessories at lenovo.com/accessories 		

See footnotes for important warranty information
US models announced October 21, 2008

© Lenovo
(MLAN1-5) October 2008

ThinkCentre® M58p Small (7220) - ENERGY STAR® 4.0

Personal Systems Reference (PSREF)

Name	Type-model	Slot x bay	Processor	GHz	Cores	Memory ⁶	SATA disk	SATA optical	Graphics	Monitor conn	DisplayPort dongle	ENERGY STAR 4.0	Intel vPro	Vista preload	Global Educ	Avail date
M58p	7220-A6U	2x3	Core 2 Duo E8400	3.00	2	1GB	160GB ²	DVD	GMA	VGA, DP		ES40	vPro	Bus32	No	Nov 08
M58p	7220-A7U	2x3	Core 2 Duo E8400	3.00	2	2GB	250GB	DVD	3470	VGA, DP	DP-to-DVI-D	ES40	vPro	Bus32	No	Nov 08
M58p	7220-A8U	2x3	Core 2 Duo E8500	3.16	2	1GB	250GB	DVD	GMA	VGA, DP		ES40	vPro	Bus32	No	Nov 08
M58p	7220-A9U	2x3	Core 2 Duo E8500	3.16	2	2GB	250GB	DVD	3470	VGA, DP	DP-to-DVI-D	ES40	vPro	Bus32	No	Nov 08
M58p	7220-ABU	2x3	Core 2 Duo E8500	3.16	2	2GB	250GB	DVD±RW	GMA	VGA, DP	DP-to-DVI-D	ES40	vPro	Bus32	No	Nov 08

- **Intel Core 2 Processor with vPro™ Technology (includes Intel Active Management Technology)**
- **These models have a 3-year limited warranty¹**

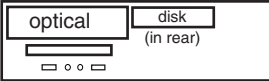
Positioning Processor	<i>Ultimate stability/manageability for large enterprise and mid-market</i> Intel® Core™ 2 Duo Processor E8400 or E8500 with dual-core , Virtualization Technology, TXT, 1333MHz system bus, and 6MB L2 cache	Small																																														
Implementation	Processor in FC-LGA8 package in LGA775 socket																																															
Memory	1GB or 2GB std , 8GB max ⁸ , PC3-8500 1066MHz DDR3 , non-parity, dual-channel capable, four 240-pin DIMM sockets; <i>Italics:</i> standard memory in two sockets; two sockets available; <i>Non-italics:</i> standard memory in one socket; 3 sockets available	Bay ① 5.25", 1.6" high, access, std optical Bay ② 3.5", 1" high, no access, std disk Bay ③ 3.5", .5" high, access, open (reader)																																														
Graphics	<i>Some:</i> Intel Graphics Media Accelerator 4500 (GMA 4500) , integrated graphics in Q45, uses main memory (up to 253MB [1GB system mem], 765MB [2GB system mem]), one analog VGA DB-15 connector, one DisplayPort™ conn, HDCP, DirectX® 10, supports dual independent display <i>Some:</i> ATI™ Radeon™ HD 3470 , PCI Express® 2.0 x16 adapter, 256MB, one analog VGA DB-15 connector, one DisplayPort connector, HDCP, DirectX 10.1, ATI Avivo™, 25 watts	Slot 1: Low Profile, PCI Express 2.0 x16* Slot 2: Low Profile, 32-bit PCI 2.3 * used in some models																																														
DP dongle	<i>Some:</i> DisplayPort to Single-link DVI-D Cable (45J7915)	<ul style="list-style-type: none"> • Business black color; metal case • 12.5" W X 14.0" D X 3.9" H • 317mm W X 355mm D X 99mm H • 16.5 lb (7.5 kg) in maximum configuration • Toolless cover flips up and tilts backward on rear hinges • Toolless disk, optical drive removal • Toolless adapter retention • Toolless systemboard retention • System floor stand for vertical orientation 																																														
SATA disk	160GB or 250GB , SATA 3.0Gb/s 7200 rpm, vibration dampening	Security	<ul style="list-style-type: none"> • Security chip (see information on left) • Security slot (in rear for attachment of optional Kensington® Microsaver® cable) - optional cable also locks the cover by deactivating the cover release buttons • Power-on password • Administrator password • Hard disk password (user and master) • Boot sequence control • Boot without diskette, keyboard • Serial port I/O control • Individual USB port disablement 																																													
SATA controller	Serial ATA, SATA 3.0Gb/s, integrated in ICH10DO, RAID 0/1																																															
SATA DVD	<i>Some:</i> DVD-ROM DL SATA 1.5Gb/s 16-48X Max ⁴ Drive (41N5618)	Supports ThinkVantage® technologies																																														
SATA DVD±RW	<i>Some:</i> Super Multi-Burner DL DVD±RW SATA 1.5Gb/s Drive (41N5620)	Climate Savers®-compliant EPEAT™ Gold rating ENERGY STAR 4.0-compliant GREENGUARD® certified RoHS-compliant																																														
SATA cables	Two SATA cables (each 1-drop to device), two SATA connectors on planar	Limited Warranty¹	<ul style="list-style-type: none"> ↪ 3-year parts and labor ↪ International Warranty Service⁹ ↪ Customer Replaceable Unit (CRU) parts only (with limited onsite service for selected parts³, 8 am - 5 pm, Mon - Fri coverage excluding holidays, next business day response time) ↪ Onsite service upgrade options (in eligible locations):⁷ <ul style="list-style-type: none"> • 3-year LOR 9x5, 4 hour response (ThinkPlus™ part number 41C9192) • 3-year LOR 24x7, 4 hour response (ThinkPlus part number 41C9193) • 4-year LOR 9x5, Next Business Day (ThinkPlus part number 41C9194) • 4-year LOR 9x5, 4 hour response (ThinkPlus part number 41C9195) • 4-year LOR 24x7, 4 hour response (ThinkPlus part number 41C9196) ↪ ThinkPlus services at lenovo.com/thinkplus/warranty ↪ Post warranty maintenance services available ↪ 24 hour x 7 day¹⁴ toll-free support during the warranty period¹ via 800-426-7378 																																													
eSATA port	One external SATA (eSATA) port																																															
Diskette drive	None	Keyboard Preferred Pro USB Keyboard (USB connector), 104-key, black, Lenovo logo Mouse Optical Wheel Mouse (USB connector), 400 dpi, black, Lenovo logo Power supply 280 watts with variable speed fan, autosenesing, 85% PSU																																														
Media reader	None	Chipset Intel Q45 Express Chipset (PCI Express 2.0 x16), I/O Controller Hub 10 Digital Office [ICH10DO] (SATA 3.0Gb/s with RAID 0/1 support, PCI Express x1, ethernet MAC, PCI 2.3, USB, LPC bus), SMSC® SCH5617 Super I/O																																														
Chipset	Intel Q45 Express Chipset (PCI Express 2.0 x16), I/O Controller Hub 10 Digital Office [ICH10DO] (SATA 3.0Gb/s with RAID 0/1 support, PCI Express x1, ethernet MAC, PCI 2.3, USB, LPC bus), SMSC® SCH5617 Super I/O	Preloaded operating system ²⁰ - Microsoft® Windows® Vista® Business Edition (32-bit) ↕ Vista Premium logo Preloaded applications ⁵ <ul style="list-style-type: none"> • Rescue and Recovery™ • Client Security Solution™ • ThinkVantage Productivity Center • ThinkVantage System Update • ThinkVantage Power Manager • Norton Internet Security™ (90 days of virus definitions) • Diskeeper® Home • PC-Doctor™ (diagnostics) • Adobe® Reader • Windows Live™ Toolbar • Windows Live Search • Picasa from Google • Microsoft Office 2007 Trial (60-day) • Sonic RecordNow and Drive Letter Access (DVD±RW) • Corel® WinDVD® (DVD, DVD±RW) Accessories <table border="0"> <tr><td>1GB PC3-8500 DDR3 UDIMM</td><td>45J5434</td></tr> <tr><td>2GB PC3-8500 DDR3 UDIMM</td><td>45J5435</td></tr> <tr><td>500GB SATA 3.0Gb/s Disk (7200 rpm)</td><td>43R1990</td></tr> <tr><td>1TB SATA 3.0Gb/s Disk (7200 rpm)</td><td>45J7918</td></tr> <tr><td>USB Portable Diskette Drive</td><td>05K9276</td></tr> <tr><td>USB 2.0 Lenovo Multimedia Headset</td><td>40Y8518</td></tr> <tr><td>USB 2.0 Lenovo Webcam</td><td>40Y8519</td></tr> <tr><td>USB 2.0 Essential Memory Key 32GB</td><td>45K1258</td></tr> <tr><td>USB 2.0 Security Memory Key 2GB</td><td>41U5119</td></tr> <tr><td>USB 2.0 Security Memory Key 4GB</td><td>41U5120</td></tr> <tr><td>USB 2.0 Ultra Secure Memory Key 2GB</td><td>45J5916</td></tr> <tr><td>USB 2.0 Ultra Secure Memory Key 4GB</td><td>45J5917</td></tr> <tr><td>USB 2.0 Ultra Secure Memory Key 8GB</td><td>45J5918</td></tr> <tr><td>USB 2.0 Portable 160GB Hard Disk</td><td>43R1784</td></tr> <tr><td>USB 2.0 Portable Secure 320GB Hard Disk</td><td>43R2019</td></tr> <tr><td>USB 2.0 Super Multi-Burner Drive</td><td>41N5565</td></tr> <tr><td>ThinkVision® L2440x Wide 24" Monitor</td><td>4421HB2</td></tr> <tr><td>Wireless Kbd & Opt Wheel Mouse (via USB)</td><td>73P4067</td></tr> <tr><td>Laser Tilt Wheel Mouse (USB, PS/2)</td><td>41U3074</td></tr> <tr><td>Kensington Cable Lock from Lenovo</td><td>73P2582</td></tr> <tr><td>ATI Radeon HD 3470 256MB (DP, VGA)</td><td>45K1636</td></tr> <tr><td>Acc Guide in pdf lenovo.com/accessoriesguide</td><td></td></tr> <tr><td>Other accessories at lenovo.com/accessories</td><td></td></tr> </table>	1GB PC3-8500 DDR3 UDIMM	45J5434	2GB PC3-8500 DDR3 UDIMM	45J5435	500GB SATA 3.0Gb/s Disk (7200 rpm)	43R1990	1TB SATA 3.0Gb/s Disk (7200 rpm)	45J7918	USB Portable Diskette Drive	05K9276	USB 2.0 Lenovo Multimedia Headset	40Y8518	USB 2.0 Lenovo Webcam	40Y8519	USB 2.0 Essential Memory Key 32GB	45K1258	USB 2.0 Security Memory Key 2GB	41U5119	USB 2.0 Security Memory Key 4GB	41U5120	USB 2.0 Ultra Secure Memory Key 2GB	45J5916	USB 2.0 Ultra Secure Memory Key 4GB	45J5917	USB 2.0 Ultra Secure Memory Key 8GB	45J5918	USB 2.0 Portable 160GB Hard Disk	43R1784	USB 2.0 Portable Secure 320GB Hard Disk	43R2019	USB 2.0 Super Multi-Burner Drive	41N5565	ThinkVision® L2440x Wide 24" Monitor	4421HB2	Wireless Kbd & Opt Wheel Mouse (via USB)	73P4067	Laser Tilt Wheel Mouse (USB, PS/2)	41U3074	Kensington Cable Lock from Lenovo	73P2582	ATI Radeon HD 3470 256MB (DP, VGA)	45K1636	Acc Guide in pdf lenovo.com/accessoriesguide		Other accessories at lenovo.com/accessories	
1GB PC3-8500 DDR3 UDIMM	45J5434																																															
2GB PC3-8500 DDR3 UDIMM	45J5435																																															
500GB SATA 3.0Gb/s Disk (7200 rpm)	43R1990																																															
1TB SATA 3.0Gb/s Disk (7200 rpm)	45J7918																																															
USB Portable Diskette Drive	05K9276																																															
USB 2.0 Lenovo Multimedia Headset	40Y8518																																															
USB 2.0 Lenovo Webcam	40Y8519																																															
USB 2.0 Essential Memory Key 32GB	45K1258																																															
USB 2.0 Security Memory Key 2GB	41U5119																																															
USB 2.0 Security Memory Key 4GB	41U5120																																															
USB 2.0 Ultra Secure Memory Key 2GB	45J5916																																															
USB 2.0 Ultra Secure Memory Key 4GB	45J5917																																															
USB 2.0 Ultra Secure Memory Key 8GB	45J5918																																															
USB 2.0 Portable 160GB Hard Disk	43R1784																																															
USB 2.0 Portable Secure 320GB Hard Disk	43R2019																																															
USB 2.0 Super Multi-Burner Drive	41N5565																																															
ThinkVision® L2440x Wide 24" Monitor	4421HB2																																															
Wireless Kbd & Opt Wheel Mouse (via USB)	73P4067																																															
Laser Tilt Wheel Mouse (USB, PS/2)	41U3074																																															
Kensington Cable Lock from Lenovo	73P2582																																															
ATI Radeon HD 3470 256MB (DP, VGA)	45K1636																																															
Acc Guide in pdf lenovo.com/accessoriesguide																																																
Other accessories at lenovo.com/accessories																																																

See footnotes for important warranty information
 US models announced October 21, 2008

ThinkCentre® M58p Small (6137) - GMP

Personal Systems Reference (PSREF)

Name	Type-model	Slot x bay	Processor	GHz	Cores	Memory ^a	SATA disk	SATA optical	Graphics	Monitor conn	DisplayPort dongle	Chassis intr switch	Intel vPro	Vista preload	Global (G) GMP (P)	Avail date
ES* M58p	6137-A2U	2x3	Core 2 Duo E8400	3.00	2	2GB	160GB ²	DVD	GMA	VGA, DP	None		vPro	Bus32	G P	Jan 09
M58p	6137-A1U	2x3	Core 2 Duo E8400	3.00	2	2GB	160GB	DVD±RW	GMA	VGA, DP	None	Switch	vPro	Bus32	G P	Nov 08

- **Intel Core 2 Processor with vPro™ Technology (includes Intel Active Management Technology)**
- **These models are part of the Global Models Plus (GMP) program with limited onsite service³ 3-year limited warranty**

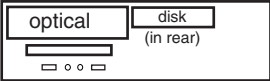
Positioning Processor	<i>Ultimate stability/manageability for large enterprise and mid-market</i>		Small	
Implementation	Processor in FC-LGA8 package in LGA775 socket		Bay ① 5.25", 1.6" high, access, std optical	
Memory	2GB std, 8GB max⁸, PC3-8500 1066MHz DDR3, non-parity, dual-channel capable, four 240-pin DIMM sockets; <i>Italics:</i> standard memory in two sockets; two sockets available		Bay ② 3.5", 1" high, no access, std disk	
Graphics	Intel Graphics Media Accelerator 4500 (GMA 4500), integrated graphics in Q45, uses main memory (up to 765MB), one analog VGA DB-15 connector, one DisplayPort™ connector (supports single-link DVI-D via cable 45J7915), HDCP, DirectX® 10, supports dual independent display		Bay ③ 3.5", .5" high, access, open (reader)	
SATA disk	160GB, SATA 3.0Gb/s 7200 rpm, vibration dampening mounts		Slot 1: Low Profile, PCI Express 2.0 x16	
SATA controller	Serial ATA, SATA 3.0Gb/s, integrated in ICH10DO, RAID 0/1		Slot 2: Low Profile, 32-bit PCI 2.3	
SATA DVD	<i>Some:</i> DVD-ROM DL SATA 1.5Gb/s 16-48X Max ⁴ Drive (41N5618)		• Business black color; metal case	
SATA DVD±RW	<i>Some:</i> Super Multi-Burner DL DVD±RW SATA Drive (41N5620)		• 12.5" W X 14.0" D X 3.9" H	
SATA cables	Two SATA cables (each 1-drop to device), two SATA connectors		• 317mm W X 355mm D X 99mm H	
eSATA port	One external SATA (eSATA) port		• 16.5 lb (7.5 kg) in maximum configuration	
Diskette drive	None		• Toolless cover flips up and tilts backward on rear hinges	
Media reader	None		• Toolless disk, optical drive removal	
Chipset	Intel Q45 Express Chipset (PCI Express® 2.0 x16), I/O Controller Hub 10 Digital Office [ICH10DO] (SATA 3.0Gb/s with RAID 0/1 support, PCI Express x1, ethernet MAC, PCI 2.3, USB, LPC bus), SMSC® SCH5617 Super I/O		• Toolless adapter retention	
Front ports	Two USB 2.0, microphone (stereo, 3.5mm), headphone (stereo, 3.5mm)		• Toolless systemboard retention	
Rear ports	Six USB 2.0, serial (9-pin), ethernet (RJ-45), monitor (VGA DB-15, DisplayPort), eSATA		• System floor stand for vertical orientation	
Internal connector	Two USB 2.0 planar conn (1 used; one open for media reader or 2 rear USB ports)			Security
Rear audio ports	Line-in (stereo, 3.5mm), line-out (stereo, 3.5mm), microphone-in (stereo, 3.5mm)			• Security chip (see information on left)
Audio	High Definition (HD) Audio, Analog Devices AD1882 codec			• Security slot (in rear for attachment of optional Kensington® Microsaver® cable) - optional cable also locks the cover by deactivating the cover release buttons
Speaker	One internal speaker for business audio			• Power-on password
Ethernet	Gigabit ethernet on planar, Intel 82567LM, Wake on LAN®, ASF2.0, DASH 1.0			• Administrator password
Intel AMT	Intel Active Management Technology (iAMT)			• Hard disk password (user and master)
Modem	None			• Boot sequence control
Security chip	Winbond® WPCT200 SafeKeeper™ Trusted Platform Module, TCG 1.2-compliant			• Boot without diskette, keyboard
Keyboard	Preferred Pro USB Keyboard (USB connector), 104-key, black, Lenovo logo			• Serial port I/O control
Mouse	Optical Wheel Mouse (USB connector), 400 dpi, black, Lenovo logo			• Individual USB port disablement
Power supply	280 watts with variable speed fan, autosensing, two diagnostic LEDs			• <i>Some:</i> Chassis intrusion switch
Preloaded operating system²⁰	Accessories			
- Microsoft® Windows® Vista® Business Edition (32-bit)	1GB PC3-8500 DDR3 UDIMM	45J5434		
↳ Vista Premium logo	2GB PC3-8500 DDR3 UDIMM	45J5435		
Preloaded applications⁵	500GB SATA 3.0Gb/s Disk (7200 rpm)	43R1990		
• Rescue and Recovery™	1TB SATA 3.0Gb/s Disk (7200 rpm)	45J7918		
• Client Security Solution™	USB Portable Diskette Drive	05K9276		
• ThinkVantage Productivity Center	USB 2.0 Lenovo Multimedia Headset	40Y8518		
• ThinkVantage System Update	USB 2.0 Lenovo Webcam	40Y8519		
• ThinkVantage Power Manager	USB 2.0 Essential Memory Key 32GB	45K1258		
• Norton Internet Security™ (90 days of virus definitions)	USB 2.0 Security Memory Key 2GB	41U5119		
• Diskeeper® Home	USB 2.0 Security Memory Key 4GB	41U5120		
• PC-Doctor™ (diagnostics)	USB 2.0 Ultra Secure Memory Key 2GB	45J5916		
• Adobe® Reader	USB 2.0 Ultra Secure Memory Key 4GB	45J5917		
• Windows Live™ Toolbar	USB 2.0 Ultra Secure Memory Key 8GB	45J5918		
• Windows Live Search	USB 2.0 Portable 160GB Hard Disk	43R1784		
• Picasa from Google	USB 2.0 Portable Secure 320GB Hard Disk	43R2019		
• Microsoft Office 2007 Trial (60-day)	USB 2.0 Super Multi-Burner Drive	41N5565		
• Sonic RecordNow and Drive Letter Access (DVD±RW)	ThinkVision® L2440x Wide 24" Monitor	4421HB2		
• Corel® WinDVD® (DVD, DVD±RW)	DisplayPort to Single-link DVI-D Cable	45J7915		
	Wireless Kbd & Opt Wheel Mouse (via USB)	73P4067		
	Lenovo USB Fingerprint Keyboard	73P4730		
	Laser Tilt Wheel Mouse (USB, PS/2)	41U3074		
	Kensington Cable Lock from Lenovo	73P2582		
	Kensington Twin Head Cable Lock	45K1620		
	ATI™ Radeon™ HD 3470 256MB (DP, VGA)	45K1636		
	Acc Guide in pdf lenovo.com/accessoriesguide			
	Other accessories at lenovo.com/accessories			
				Supports ThinkVantage® technologies
				GREENGUARD® certified RoHS-compliant
				Limited Warranty¹
				↳ 3-year parts and labor
				↳ International Warranty Service⁹
				↳ Customer Replaceable Unit (CRU) parts only (with limited onsite service for selected parts³, 8 am - 5 pm, Mon - Fri coverage excluding holidays, next business day response time)
				↳ Onsite service upgrade options (in eligible locations):⁷
				• 4-year LOR 9x5, Next Business Day (ThinkPlus part number 41C9194)
				• 4-year LOR 9x5, 4 hour response (ThinkPlus part number 41C9195)
				• 4-year LOR 24x7, 4 hour response (ThinkPlus part number 41C9196)
				↳ ThinkPlus services at lenovo.com/thinkplus/warranty
				↳ Post warranty maintenance services available
				↳ 24 hour x 7 day¹⁴ toll-free support during the warranty period¹ via 800-426-7378

See footnotes for important warranty information

ES* US model announced December 9, 2008; previous model on October 21, 2008

© Lenovo
(MLAN1-7) December 2008

ThinkCentre® M58p Small (6234) - ENERGY STAR® 4.0 (GMP)

Personal Systems Reference (PSREF)

Name	Type-model	Slot x bay	Processor	GHz Cores	Memory ⁸	SATA disk	SATA optical	Graphics	Monitor conn	DisplayPort dongle	ENERGY STAR 4.0	Intel vPro	Vista preload	Global (G) GMP (P)	Avail date
M58p	6234-A1U	2x3	Core 2 Duo E8400	3.00 2	2GB	160GB ²	DVD±RW	GMA	VGA, DP	None	ES40	vPro	Bus32	G P	Nov 08

- **Intel Core 2 Processor with vPro™ Technology (includes Intel Active Management Technology)**
- **This model is part of the Global Models Plus (GMP) program with limited onsite service³ 3-year limited warranty**

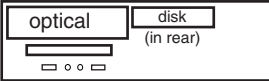
Positioning Processor	<i>Ultimate stability/manageability for large enterprise and mid-market</i> Intel® Core™ 2 Duo Processor E8400 with dual-core , Virtualization Technology, TXT, 1333MHz system bus, and 6MB L2 cache	Small	
Implementation	Processor in FC-LGA8 package in LGA775 socket		
Memory	2GB std , 8GB max ⁸ , PC3-8500 1066MHz DDR3 , non-parity, dual-channel capable, four 240-pin DIMM sockets; <i>Italics:</i> standard memory in two sockets; two sockets available	Bay ① 5.25", 1.6" high, access, std optical Bay ② 3.5", 1" high, no access, std disk Bay ③ 3.5", .5" high, access, open (reader)	
Graphics	Intel Graphics Media Accelerator 4500 (GMA 4500) , integrated graphics in Q45, uses main memory (up to 765MB), one analog VGA DB-15 connector, one DisplayPort™ connector (supports single-link DVI-D via cable 45J7915), HDCP, DirectX® 10, supports dual independent display	Slot 1: Low Profile, PCI Express 2.0 x16 Slot 2: Low Profile, 32-bit PCI 2.3	
SATA disk	160GB , SATA 3.0Gb/s 7200 rpm, vibration dampening mounts	Security <ul style="list-style-type: none"> • Security chip (see information on left) • Security slot (in rear for attachment of optional Kensington® Microsaver® cable) - optional cable also locks the cover by deactivating the cover release buttons • Power-on password • Administrator password • Hard disk password (user and master) • Boot sequence control • Boot without diskette, keyboard • Serial port I/O control • Individual USB port disablement • Chassis intrusion switch 	
SATA controller	Serial ATA, SATA 3.0Gb/s, integrated in ICH10DO, RAID 0/1		
SATA DVD±RW	Super Multi-Burner DL DVD±RW SATA 1.5Gb/s Drive (41N5620)		
SATA cables	Two SATA cables (each 1-drop to device), two SATA connectors		
eSATA port	One external SATA (eSATA) port		
Diskette drive	None		
Media reader	None		
Chipset	Intel Q45 Express Chipset (PCI Express® 2.0 x16), I/O Controller Hub 10 Digital Office [ICH10DO] (SATA 3.0Gb/s with RAID 0/1 support, PCI Express x1, ethernet MAC, PCI 2.3, USB, LPC bus), SMSC® SCH5617 Super I/O		
Front ports	Two USB 2.0, microphone (stereo, 3.5mm), headphone (stereo, 3.5mm)		
Rear ports	Six USB 2.0, serial (9-pin), ethernet (RJ-45), monitor (VGA DB-15, DisplayPort), eSATA		
Internal connector	Two USB 2.0 planar conn (1 used; one open for media reader or 2 rear USB ports)		
Rear audio ports	Line-in (stereo, 3.5mm), line-out (stereo, 3.5mm), microphone-in (stereo, 3.5mm)		
Audio	High Definition (HD) Audio, Analog Devices AD1882 codec		
Speaker	One internal speaker for business audio		
Ethernet	Gigabit ethernet on planar, Intel 82567LM, Wake on LAN®, ASF2.0, DASH 1.0		
Intel AMT	Intel Active Management Technology (iAMT)		
Modem	None		
Security chip	Winbond® WPCT200 SafeKeeper™ Trusted Platform Module, TCG 1.2-compliant		
Keyboard	Preferred Pro USB Keyboard (USB connector), 104-key, black, Lenovo logo		
Mouse	Optical Wheel Mouse (USB connector), 400 dpi, black, Lenovo logo		
Power supply	280 watts with variable speed fan, autosenesing, 85% PSU		
Preloaded operating system²⁰	Accessories	Supports ThinkVantage® technologies	
- Microsoft® Windows® Vista® Business Edition (32-bit)	1GB PC3-8500 DDR3 UDIMM 45J5434	Climate Savers®-compliant	
↕ Vista Premium logo	2GB PC3-8500 DDR3 UDIMM 45J5435		
Preloaded applications⁵	500GB SATA 3.0Gb/s Disk (7200 rpm) 43R1990	EPEAT™ Gold rating	
• Rescue and Recovery™	1TB SATA 3.0Gb/s Disk (7200 rpm) 45J7918	ENERGY STAR 4.0-compliant	
• Client Security Solution™	USB Portable Diskette Drive 05K9276	GREENGUARD® certified	
• ThinkVantage Productivity Center	USB 2.0 Lenovo Multimedia Headset 40Y8518	RoHS-compliant	
• ThinkVantage System Update	USB 2.0 Lenovo Webcam 40Y8519		
• ThinkVantage Power Manager	USB 2.0 Essential Memory Key 32GB 45K1258		
• Norton Internet Security™ (90 days of virus definitions)	USB 2.0 Security Memory Key 2GB 41U5119		
• Diskeeper® Home	USB 2.0 Security Memory Key 4GB 41U5120		
• PC-Doctor™ (diagnostics)	USB 2.0 Ultra Secure Memory Key 2GB 45J5916		
• Adobe® Reader	USB 2.0 Ultra Secure Memory Key 4GB 45J5917		
• Windows Live™ Toolbar	USB 2.0 Ultra Secure Memory Key 8GB 45J5918		
• Windows Live Search	USB 2.0 Portable 160GB Hard Disk 43R1784		
• Picasa from Google	USB 2.0 Portable Secure 320GB Hard Disk 43R2019		
• Microsoft Office 2007 Trial (60-day)	USB 2.0 Super Multi-Burner Drive 41N5565		
• Sonic RecordNow and Drive Letter Access (DVD±RW)	ThinkVision® L2440x Wide 24" Monitor 4421HB2		
• Corel® WinDVD® (DVD±RW)	DisplayPort to Single-link DVI-D Cable 45J7915		
	Wireless Kbd & Opt Wheel Mouse (via USB) 73P4067		
	Lenovo USB Fingerprint Keyboard 73P4730		
	Laser Tilt Wheel Mouse (USB, PS/2) 41U3074		
	Kensington Cable Lock from Lenovo 73P2582		
	Kensington Twin Head Cable Lock 45K1620		
	ATI™ Radeon™ HD 3470 256MB (DP, VGA) 45K1636		
	Acc Guide in pdf lenovo.com/accessoriesguide		
	Other accessories at lenovo.com/accessories		
		Limited Warranty¹	
		↔ 3-year parts and labor	
		↔ International Warranty Service⁹	
		↔ Customer Replaceable Unit (CRU) parts only (with limited onsite service for selected parts³, 8 am - 5 pm, Mon - Fri coverage excluding holidays, next business day response time)	
		↔ Onsite service upgrade options (in eligible locations):⁷	
		• 4-year LOR 9x5, Next Business Day (ThinkPlus part number 41C9194)	
		• 4-year LOR 9x5, 4 hour response (ThinkPlus part number 41C9195)	
		• 4-year LOR 24x7, 4 hour response (ThinkPlus part number 41C9196)	
		↔ ThinkPlus services at lenovo.com/thinkplus/warranty	
		↔ Post warranty maintenance services available	
		↔ 24 hour x 7 day¹⁴ toll-free support during the warranty period¹ via 800-426-7378	

See footnotes for important warranty information
US model announced October 21, 2008

© Lenovo
(MLAN1-8) October 2008

Name	Type-model	Slot x bay	Processor	GHz	Cores	Memory ⁸	SATA disk	SATA optical	Graphics	Monitor connectors	DisplayPort dongle	Intel vPro	Preload	Global Educ	Avail date
M58p	9965-A1U	4x4	Core 2 Duo E8400	3.00	2	2GB	160GB ²	DVD±RW	GMA	VGA, DP	None	vPro	XP Pro	None	Nov 08
M58p	9965-A2U	4x4	Core 2 Quad Q9400	2.66	4	2GB	250GB	DVD±RW	GMA	VGA, DP	None	vPro	XP Pro	None	Nov 08

- Intel Core 2 Processor with vPro™ Technology (includes Intel Active Management Technology)
- These small and medium business (SMB) models are part of the US TopSeller™ Program
- These models have a 3-year limited warranty¹

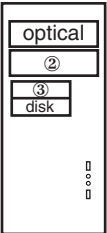
Positioning Processor	Ultimate stability/manageability for small and medium businesses Intel® Core™ 2 Duo Processor E8400 with dual-core, Virtualization Technology, TXT, 1333MHz system bus, and 6MB L2 cache or Intel Core 2 Quad Processor Q9400 with quad-core, Virtualization Technology, TXT, 1333MHz system bus, and 6MB L2 cache		Tower					
Implementation	Processor in FC-LGA8 package in LGA775 socket		<ul style="list-style-type: none"> • Business black color; metal case • 6.9" W X 17.3" D X 15.8" H • 175mm W X 440mm D X 402mm H • 24.2 lb (11.0 kg) in max configuration • Handle on top front • Toolless cover removal • Toolless disk, diskette drive, optical drive removal • Toolless adapter retention 					
Memory	2GB std , 8GB max ⁸ , PC3-8500 1066MHz DDR3 , non-parity, dual-channel capable, four 240-pin DIMM sockets; <i>Italics:</i> standard memory in two sockets; two sockets available		Bay ① 5.25", 1.6" high, access, std optical Bay ② 5.25", 1.6" high, access, open Bay ③ 3.5", 1" high, access, open (reader/diskette) Bay ④ 3.5", 1" high, no access, std disk					
Graphics	Intel Graphics Media Accelerator 4500 (GMA 4500) , integrated graphics in Q45, uses main memory (up to 1GB), one analog VGA DB-15 connector, one DisplayPort™ connector (supports single-link DVI-D via cable 45J7915), HDCP, DirectX® 10, supports dual independent display		Slot 1: half-length, full-height, PCIe 2.0 x16 (75w max) Slot 2: half-length, full-height, PCIe x1 Slot 3: half-length, full-height, 32-bit PCI 2.3 Slot 4: half-length, full-height, 32-bit PCI 2.3					
SATA disk	160GB or 250GB , SATA 3.0Gb/s 7200 rpm, vibration dampening Serial ATA, SATA 3.0Gb/s, integrated in ICH10DO, RAID 0/1		Security <ul style="list-style-type: none"> • Security chip (see information on left) • One lock to secure both cover and entire system to fixed object: <ul style="list-style-type: none"> - Padlock loop (in rear for opt padlock) - Security slot (in rear for optional Kensington® Microsaver® cable) • Power-on password • Administrator password • Hard disk password (user and master) • Boot sequence control • Boot without diskette, keyboard • Serial port I/O control • Individual USB port disablement Supports ThinkVantage® technologies					
SATA controller	Super Multi-Burner DL DVD±RW SATA 1.5Gb/s Drive (41N5620)							
SATA DVD±RW	Two SATA cables (each 1-drop to device), three SATA connectors and one eSATA connector on planar							
SATA cables	None							
eSATA port	None		GREENGUARD® certified RoHS-compliant					
Diskette drive	None							
Media reader	None							
Chipset	Intel Q45 Express Chipset (PCI Express® 2.0 x16), I/O Controller Hub 10 Digital Office [ICH10DO] (SATA 3.0Gb/s with RAID 0/1 support, PCI Express x1, ethernet MAC, PCI 2.3, USB, LPC bus), SMSC® SCH5617 Super I/O							
Front ports	Two USB 2.0, microphone (stereo, 3.5mm), headphone (stereo, 3.5mm)		Limited Warranty¹ <ul style="list-style-type: none"> ↔ 3-year parts and labor ↔ International Warranty Service⁹ ↔ Customer Replaceable Unit (CRU) parts only (with limited onsite service for selected parts³, 8 am - 5 pm, Mon - Fri coverage excluding holidays, next business day response time) ↔ Onsite service upgrade options (in eligible locations):⁷ <ul style="list-style-type: none"> • 3-year LOR 9x5, 4 hour response (ThinkPlus™ part number 41C9192) • 3-year LOR 24x7, 4 hour response (ThinkPlus part number 41C9193) • 4-year LOR 9x5, Next Business Day (ThinkPlus part number 41C9194) • 4-year LOR 9x5, 4 hour response (ThinkPlus part number 41C9195) • 4-year LOR 24x7, 4 hour response (ThinkPlus part number 41C9196) ↔ ThinkPlus services at lenovo.com/thinkplus/warranty ↔ Post warranty maintenance services available ↔ 24 hour x 7 day¹⁴ toll-free support during the warranty period¹ via 800-426-7378 					
Rear ports	Six USB 2.0, serial (9-pin), keyboard (PS/2), mouse (PS/2), ethernet (RJ-45), monitor (VGA DB-15, DisplayPort)							
Internal connector	Two USB 2.0 planar conn (1 used; one open for media reader or 2 rear USB ports)							
Rear audio ports	Line-in (stereo, 3.5mm), line-out (stereo, 3.5mm), microphone-in (stereo, 3.5mm)							
Audio	High Definition (HD) Audio, Analog Devices AD1882 codec							
Speaker	One internal speaker for business audio							
Ethernet	Gigabit ethernet on planar, Intel 82567LM, Wake on LAN®, ASF2.0, DASH 1.0							
Intel AMT	Intel Active Management Technology (iAMT)							
Modem	None							
Security chip	Winbond® WPCT200 SafeKeeper™ Trusted Platform Module, TCG 1.2-compliant							
Keyboard	Preferred Pro USB Keyboard (USB connector), 104-key, black, Lenovo logo					See footnotes for important warranty information US models announced October 21, 2008		
Mouse	Optical Wheel Mouse (USB connector), black, Lenovo logo							
Power supply	280 watts with variable speed fan, manual switch, two diagnostic LEDs							
Preloaded operating system²⁰	- Microsoft® Windows® XP Professional with Vista® COA ↕ Disk-to-Disk Recovery (in hidden protected area) ↕ Vista Basic logo		Accessories					
Preloaded applications⁵	<ul style="list-style-type: none"> • Rescue and Recovery™ • Client Security Solution™ • ThinkVantage Productivity Center • ThinkVantage System Update • Norton Internet Security™ (90 days of virus definitions) • Diskeeper® Home • PC-Doctor™ (diagnostics) • Adobe® Reader • Windows Live™ Toolbar • Windows Live Search • Picasa from Google • Microsoft Office 2007 Trial (60-day) • Multimedia Center for Think Offerings (DVD±RW) • Sonic RecordNow and Drive Letter Access (DVD±RW) • Corel® WinDVD® (DVD±RW) • Corel WinDVD Creator (DVD±RW) 		<ul style="list-style-type: none"> 1GB PC3-8500 DDR3 UDIMM 45J5434 2GB PC3-8500 DDR3 UDIMM 45J5435 500GB SATA 3.0Gb/s Disk (7200 rpm) 43R1990 1TB SATA 3.0Gb/s Disk (7200 rpm) 45J7918 USB Portable Diskette Drive 05K9276 USB 2.0 Lenovo Multimedia Headset 40Y8518 USB 2.0 Lenovo Webcam 40Y8519 USB 2.0 Essential Memory Key 32GB 45K1258 USB 2.0 Ultra Secure Memory Key 4GB 45J5917 USB 2.0 Ultra Secure Memory Key 8GB 45J5918 USB 2.0 Portable 160GB Hard Disk 43R1784 USB 2.0 Portable Secure 320GB Hard Disk 43R2019 Blu-ray Burner / HD-DVD Player SATA Drive 43R1958 ThinkVision® L2440x Wide 24" Monitor 4421HB2 DisplayPort to Single-link DVI-D Cable 45J7915 Wireless Kbd & Opt Wheel Mouse (via USB) 73P4067 Lenovo USB Fingerprint Keyboard 73P4730 Laser Tilt Wheel Mouse (USB, PS/2) 41U3074 Kensington Cable Lock from Lenovo 73P2582 Kensington Twin Head Cable Lock 45K1620 ATI™ Radeon™ HD 3470 256MB (DP, VGA) 45K1636 NVIDIA® GeForce® 9500GT 512MB (DP, DVI) 45K1635 NVIDIA Quadro® 256MB FX 370 43R1766 NVIDIA Quadro 512MB FX 1700 43R1767 Acc Guide in pdf lenovo.com/accessoriesguide Other accessories at lenovo.com/accessories 					

See footnotes for important warranty information
US models announced October 21, 2008

Name	Type-model	Slot x bay	Processor	GHz	Cores	Memory ⁶	SATA disk	SATA optical	Graphics	Monitor conn	DisplayPort dongle	Chassis intr switch	Intel vPro	Vista preload	Global Educ	Avail date
M58p	7484-A9U	4x4	Core 2 Duo E8400	3.00	2	1GB	160GB ²	DVD	GMA	VGA, DP			vPro	Bus32		Nov 08
M58p	7484-AHU	4x4	Core 2 Duo E8400	3.00	2	1GB	160GB	DVD±RW	GMA	VGA, DP	DP-to-DVI-D		vPro	Bus32		Nov 08
M58p	7484-AEU	4x4	Core 2 Duo E8400	3.00	2	2GB	160GB	DVD±RW	GMA	VGA, DP			vPro	Bus32		Nov 08
M58p	7484-AGU	4x4	Core 2 Duo E8400	3.00	2	2GB	250GB	DVD	3470	VGA, DP	DP-to-DVI-D		vPro	Bus32		Nov 08
M58p	7484-A8U	4x4	Core 2 Duo E8400	3.00	2	2GB	250GB	DVD±RW	GMA	VGA, DP		Switch	vPro	Bus32		Nov 08
M58p	7484-AJU	4x4	Core 2 Duo E8500	3.16	2	1GB	160GB	DVD	GMA	VGA, DP			vPro	Bus32		Nov 08
M58p	7484-AMU	4x4	Core 2 Duo E8500	3.16	2	2GB	160GB	DVD±RW	GMA	VGA, DP			vPro	Bus32	Educ	Nov 08
M58p	7484-ALU	4x4	Core 2 Duo E8500	3.16	2	2GB	250GB	DVD	GMA	VGA, DP			vPro	Bus32		Nov 08
M58p	7484-AKU	4x4	Core 2 Duo E8500	3.16	2	2GB	250GB	DVD	3470	VGA, DP	DP-to-DVI-D		vPro	Bus32		Nov 08
M58p	7484-ANU	4x4	Core 2 Quad Q9400	2.66	4	2GB	160GB	DVD±RW	3470	VGA, DP	DP-to-DVI-D		vPro	Bus32		Nov 08

- Intel Core 2 Processor with vPro™ Technology (includes Intel Active Management Technology)
- These models have a 3-year limited warranty¹

Positioning Processor	Ultimate stability/manageability for large enterprise and mid-market Intel® Core™ 2 Duo Processor E8400 or E8500 with dual-core, Virtualization Technology, TXT, 1333MHz system bus, and 6MB L2 cache or Intel Core 2 Quad Processor Q9400 with quad-core, Virtualization Technology, TXT, 1333MHz system bus, and 6MB L2 cache	Tower	<ul style="list-style-type: none"> • Business black color; metal case • 6.9" W X 17.3" D X 15.8" H • 175mm W X 440mm D X 402mm H • 24.2 lb (11.0 kg) in max configuration • Handle on top front • Toolless cover removal • Toolless disk, diskette drive, optical drive removal • Toolless adapter retention 	
Implementation	Processor in FC-LGA8 package in LGA775 socket			
Memory	1GB or 2GB std, 8GB max ⁸ , PC3-8500 1066MHz DDR3, non-parity, dual-channel capable, four 240-pin DIMM sockets; <i>Italics:</i> standard memory in two sockets; two sockets available; <i>Non-italics:</i> standard memory in one socket; 3 sockets available			
Graphics	Some: Intel Graphics Media Accelerator 4500 (GMA 4500), integrated graphics in Q45, uses main memory (up to 253MB [1GB system mem], 765MB [2GB system mem]), one analog VGA DB-15 connector, one DisplayPort™ conn, HDCP, DirectX® 10, supports dual independent display Some: ATI™ Radeon™ HD 3470, PCI Express® 2.0 x16 adapter, 256MB, one analog VGA DB-15 connector, one DisplayPort connector, HDCP, DirectX 10.1, ATI Avivo™, 25 watts	<ul style="list-style-type: none"> Bay ① 5.25", 1.6" high, access, std optical Bay ② 5.25", 1.6" high, access, open Bay ③ 3.5", 1" high, access, open (reader/diskette) Bay ④ 3.5", 1" high, no access, std disk 		
DP dongle	Some: DisplayPort to Single-link DVI-D Cable (45J7915)		<ul style="list-style-type: none"> Slot 1: half-length, full-height, PCIe 2.0 x16 (75w max)* Slot 2: half-length, full-height, PCIe x1 Slot 3: half-length, full-height, 32-bit PCI 2.3 Slot 4: half-length, full-height, 32-bit PCI 2.3 	
SATA disk	160GB or 250GB, SATA 3.0Gb/s 7200 rpm, vibration dampening			
SATA controller	Serial ATA, SATA 3.0Gb/s, integrated in ICH10DO, RAID 0/1 support			
SATA DVD	Some: DVD-ROM DL SATA 1.5Gb/s 16-48X Max ⁴ Drive (41N5618)			
SATA DVD±RW	Some: Super Multi-Burner DL DVD±RW SATA 1.5Gb/s Drive (41N5620)			
SATA cables	Two SATA cables (each 1-drop to device), three SATA connectors and one eSATA connector on planar			
eSATA port	None			
Diskette drive	None			
Media reader	None			
Chipset	Intel Q45 Express Chipset (PCI Express 2.0 x16), I/O Controller Hub 10 Digital Office [ICH10DO] (SATA 3.0Gb/s with RAID 0/1 support, PCI Express x1, ethernet MAC, PCI 2.3, USB, LPC bus), SMSC® SCH5617 Super I/O			
Front ports	Two USB 2.0, microphone (stereo, 3.5mm), headphone (stereo, 3.5mm)			
Rear ports	Six USB 2.0, serial (9-pin), keyboard (PS/2), mouse (PS/2), ethernet (RJ-45), monitor (VGA DB-15, DisplayPort)			
Internal connector	Two USB 2.0 planar conn (1 used; one open for media reader or 2 rear USB ports)			
Rear audio ports	Line-in (stereo, 3.5mm), line-out (stereo, 3.5mm), microphone-in (stereo, 3.5mm)			
Audio	High Definition (HD) Audio, Analog Devices AD1882 codec			
Speaker	One internal speaker for business audio			
Ethernet	Gigabit ethernet on planar, Intel 82567LM, Wake on LAN®, ASF2.0, DASH 1.0			
Intel AMT	Intel Active Management Technology (iAMT)			
Modem	None			
Security chip	Winbond® WPCT200 SafeKeeper™ Trusted Platform Module, TCG 1.2-compliant			
Keyboard	Preferred Pro USB Keyboard (USB connector), 104-key, black, Lenovo logo			
Mouse	Optical Wheel Mouse (USB connector), black, Lenovo logo			
Power supply	280 watts with variable speed fan, manual switch, two diagnostic LEDs			

<p>Preloaded operating system²⁰</p> <ul style="list-style-type: none"> - Microsoft® Windows® Vista® Business Edition (32-bit) ◇ Vista Premium logo <p>Preloaded applications⁵ (only some listed)</p> <ul style="list-style-type: none"> • Some: Education software - VitalSource Library College Edition - Adobe® Instructor Resource Center - Adobe Digital School Collection <ul style="list-style-type: none"> - Photoshop Elements 6 (and CD) - Premier Elements 4 (and DVD) - Acrobat 8 Professional (and CD) - Contribute 4 (and CD) • Rescue and Recovery™ • Client Security Solution™ • ThinkVantage Productivity Center • ThinkVantage System Update 	<p>Accessories</p> <ul style="list-style-type: none"> 1GB PC3-8500 DDR3 UDIMM 45J5434 2GB PC3-8500 DDR3 UDIMM 45J5435 1TB SATA 3.0Gb/s Disk (7200 rpm) 45J7918 USB 2.0 Lenovo Multimedia Headset 40Y8518 USB 2.0 Lenovo Webcam 40Y8519 USB 2.0 Essential Memory Key 32GB 45K1258 USB 2.0 Portable Secure 320GB Hard Disk 43R2019 Blu-ray Burner / HD-DVD Player SATA Drive 43R1958 ThinkVision® L2440x Wide 24" Monitor 4421HB2 Wireless Kbd & Opt Wheel Mouse (via USB) 73P4067 Kensington Cable Lock from Lenovo 73P2582 ATI Radeon HD 3470 256MB (DP, VGA) 45K1636 NVIDIA® GeForce® 9500GT 512MB (DP, DVI) 45K1635 NVIDIA Quadro® 256MB FX 370 43R1766 NVIDIA Quadro 512MB FX 1700 43R1767 Other accessories at lenovo.com/accessories 	<p>Security</p> <ul style="list-style-type: none"> • Security chip (see information on left) • One lock to secure both cover and entire system to fixed object: <ul style="list-style-type: none"> - Padlock loop (in rear for opt padlock) - Security slot (in rear for optional Kensington® Microsaver® cable) • Power-on password • Administrator password • Hard disk password (user and master) • Boot sequence control • Boot without diskette, keyboard • Serial port I/O control • Individual USB port disablement • Some: Chassis intrusion switch <p>Supports ThinkVantage® technologies</p> <p>GREENGUARD® certified RoHS-compliant</p> <p>Limited Warranty¹</p> <ul style="list-style-type: none"> ⇐ 3-year parts and labor ⇐ International Warranty Service⁹ ⇐ Customer Replaceable Unit (CRU) parts only (with limited onsite service for selected parts⁷, 8 am - 5 pm, Mon - Fri coverage excluding holidays, next business day response time) ⇐ Onsite service upgrade options (in eligible locations):⁷ <ul style="list-style-type: none"> • 3-year LOR 9x5, 4 hour response (ThinkPlus™ part number 41C9192) • 3-year LOR 24x7, 4 hour response (ThinkPlus part number 41C9193) • 4-year LOR 9x5, 4 hour response (ThinkPlus part number 41C9195) • 4-year LOR 24x7, 4 hour response (ThinkPlus part number 41C9196) ⇐ Other ThinkPlus services at lenovo.com/thinkplus/warranty ⇐ 24 hour x 7 day¹⁴ toll-free support during the warranty period¹ via 800-426-7378
--	--	--

See footnotes for important warranty information
US models announced October 21, 2008

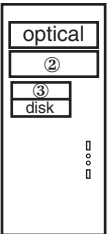
Name	Type-model	Slot x bay	Processor	GHz	Cores	Memory ⁸	SATA disk	SATA optical	Graphics	Monitor conn	DisplayPort dongle	ENERGY STAR 4.0	Intel vPro	Vista preload	Global Educ	Avail date			
M58p	7188-ABU	4x4	Core 2 Duo E8400	3.00	2	1GB	160GB ²	DVD	GMA	VGA, DP		ES40	vPro	Bus32	No	Nov 08			
M58p	7188-ABU	4x4	Core 2 Duo E8400	3.00	2	1GB	160GB	DVD±RW	GMA	VGA, DP		ES40	vPro	Bus32	No	Nov 08			
M58p	7188-A9U	4x4	Core 2 Duo E8400	3.00	2	2GB	250GB	DVD	3470	VGA, DP	DP-to-DVI-D	ES40	vPro	Bus32	No	Nov 08			
M58p	7188-ACU	4x4	Core 2 Duo E8500	3.16	2	1GB	160GB	DVD	GMA	VGA, DP		ES40	vPro	Bus32	No	Nov 08			
M58p	7188-AEU	4x4	Core 2 Duo E8500	3.16	2	1GB	250GB	DVD±RW	3470	VGA, DP	DP-to-DVI-D	ES40	vPro	Bus32	No	Nov 08			
M58p	7188-ADU	4x4	Core 2 Duo E8500	3.16	2	2GB	250GB	DVD	3470	VGA, DP		ES40	vPro	Bus32	No	Nov 08			
<ul style="list-style-type: none"> • Intel Core 2 Processor with vPro™ Technology (includes Intel Active Management Technology) • These models have a 3-year limited warranty¹ 																			
Positioning	<i>Ultimate stability/manageability for large enterprise and mid-market</i>										Tower								
Processor	Intel® Core™ 2 Duo Processor E8400 or E8500 with dual-core, Virtualization Technology, TXT, 1333MHz system bus, and 6MB L2 cache										<ul style="list-style-type: none"> • Business black color; metal case • 6.9" W X 17.3" D X 15.8" H • 175mm W X 440mm D X 402mm H • 24.2 lb (11.0 kg) in max configuration • Handle on top front • Toolless cover removal • Toolless disk, diskette drive, optical drive removal • Toolless adapter retention 								
Implementation	Processor in FC-LGA8 package in LGA775 socket										Bay ① 5.25", 1.6" high, access, std optical Bay ② 5.25", 1.6" high, access, open Bay ③ 3.5", 1" high, access, open (reader/diskette) Bay ④ 3.5", 1" high, no access, std disk								
Memory	1GB or 2GB std, 8GB max⁸, PC3-8500 1066MHz DDR3, non-parity, dual-channel capable, four 240-pin DIMM sockets; <i>Italics:</i> standard memory in two sockets; two sockets available; <i>Non-italics:</i> standard memory in one socket; 3 sockets available										Slot 1: half-length, full-height, PCIe 2.0 x16 (75w max)* Slot 2: half-length, full-height, PCIe x1 Slot 3: half-length, full-height, 32-bit PCI 2.3 Slot 4: half-length, full-height, 32-bit PCI 2.3 * used in some models								
Graphics	<i>Some:</i> Intel Graphics Media Accelerator 4500 (GMA 4500), integrated graphics in Q45, uses main memory (up to 253MB [1GB system mem], 765MB [2GB system mem]), one analog VGA DB-15 connector, one DisplayPort™ conn, HDCP, DirectX® 10, supports dual independent display <i>Some:</i> ATI™ Radeon™ HD 3470, PCI Express® 2.0 x16 adapter, 256MB, one analog VGA DB-15 connector, one DisplayPort connector, HDCP, DirectX 10.1, ATI Avivo™, 25 watts																		
DP dongle	<i>Some:</i> DisplayPort to Single-link DVI-D Cable (45J7915)																		
SATA disk	160GB or 250GB, SATA 3.0Gb/s 7200 rpm, vibration dampening																		
SATA controller	Serial ATA, SATA 3.0Gb/s, integrated in ICH10DO, RAID 0/1																		
SATA DVD	<i>Some:</i> DVD-ROM DL SATA 1.5Gb/s 16-48X Max ⁴ Drive (41N5618)																		
SATA DVD±RW	<i>Some:</i> Super Multi-Burner DL DVD±RW SATA Drive (41N5620)																		
SATA cables	Two SATA cables (each 1-drop to device), three SATA connectors and one eSATA connector on planar																		
eSATA port	None																		
Diskette drive	None																		
Media reader	None																		
Chipset	Intel Q45 Express Chipset (PCI Express 2.0 x16), I/O Controller Hub 10 Digital Office [ICH10DO] (SATA 3.0Gb/s with RAID 0/1 support, PCI Express x1, ethernet MAC, PCI 2.3, USB, LPC bus), SMSC® SCH5617 Super I/O																		
Front ports	Two USB 2.0, microphone (stereo, 3.5mm), headphone (stereo, 3.5mm)																		
Rear ports	Six USB 2.0, serial (9-pin), keyboard (PS/2), mouse (PS/2), ethernet (RJ-45), monitor (VGA DB-15, DisplayPort)																		
Internal connector	Two USB 2.0 planar conn (1 used; one open for media reader or 2 rear USB ports)																		
Rear audio ports	Line-in (stereo, 3.5mm), line-out (stereo, 3.5mm), microphone-in (stereo, 3.5mm)																		
Audio	High Definition (HD) Audio, Analog Devices AD1882 codec																		
Speaker	One internal speaker for business audio																		
Ethernet	Gigabit ethernet on planar, Intel 82567LM, Wake on LAN®, ASF2.0, DASH 1.0																		
Intel AMT	Intel Active Management Technology (iAMT)																		
Modem	None																		
Security chip	Winbond® WPCT200 SafeKeeper™ Trusted Platform Module, TCG 1.2-compliant																		
Keyboard	Preferred Pro USB Keyboard (USB connector), 104-key, black, Lenovo logo																		
Mouse	Optical Wheel Mouse (USB connector), black, Lenovo logo																		
Power supply	280 watts with variable speed fan, autosenesing, two diagnostic LEDs, 80% PSU																		
<table border="0"> <tr> <td style="vertical-align: top;"> Preloaded operating system²⁰ - Microsoft® Windows® Vista® Business Edition (32-bit) ♦ Vista Premium logo Preloaded applications⁵ • Rescue and Recovery™ • Client Security Solution™ • ThinkVantage Productivity Center • ThinkVantage System Update • ThinkVantage Power Manager • Norton Internet Security™ (90 days of virus definitions) • Diskeeper® Home • PC-Doctor™ (diagnostics) • Adobe® Reader • Windows Live™ Toolbar • Windows Live Search • Picasa from Google • Microsoft Office 2007 Trial (60-day) • Sonic RecordNow and Drive Letter Access (DVD±RW) • Corel® WinDVD® (DVD, DVD±RW) </td> <td style="vertical-align: top;"> Accessories 1GB PC3-8500 DDR3 UDIMM 45J5434 2GB PC3-8500 DDR3 UDIMM 45J5435 500GB SATA 3.0Gb/s Disk (7200 rpm) 43R1990 1TB SATA 3.0Gb/s Disk (7200 rpm) 45J7918 USB 2.0 Lenovo Multimedia Headset 40Y8518 USB 2.0 Lenovo Webcam 40Y8519 USB 2.0 Essential Memory Key 32GB 45K1258 USB 2.0 Ultra Secure Memory Key 8GB 45J5918 USB 2.0 Portable Secure 320GB Hard Disk 43R2019 USB 2.0 Super Multi-Burner Drive 41N5565 Blu-ray Burner / HD-DVD Player SATA Drive 43R1958 ThinkVision® L2440x Wide 24" Monitor 4421HB2 Wireless Kbd & Opt Wheel Mouse (via USB) 73P4067 Lenovo USB Fingerprint Keyboard 73P4730 Laser Tilt Wheel Mouse (USB, PS/2) 41U3074 Kensington Cable Lock from Lenovo 73P2582 Kensington Twin Head Cable Lock 45K1620 ATI Radeon HD 3470 256MB (DP, VGA) 45K1636 NVIDIA® GeForce® 9500GT 512MB (DP, DVI) 45K1635 NVIDIA Quadro® 256MB FX 370 43R1766 NVIDIA Quadro 512MB FX 1700 43R1767 Acc Guide in pdf lenovo.com/accessoriesguide Other accessories at lenovo.com/accessories </td> <td style="vertical-align: top;"> Supports ThinkVantage® technologies EPEAT™ Gold rating ENERGY STAR 4.0-compliant GREENGUARD® certified RoHS-compliant Limited Warranty¹ ⇨ 3-year parts and labor ⇨ International Warranty Service® ⇨ Customer Replaceable Unit (CRU) parts only (with limited onsite service for selected parts³, 8 am - 5 pm, Mon - Fri coverage excluding holidays, next business day response time) ⇨ Onsite service upgrade options (in eligible locations):⁷ • 3-year LOR 9x5, 4 hour response (ThinkPlus™ part number 41C9192) • 3-year LOR 24x7, 4 hour response (ThinkPlus part number 41C9193) • 4-year LOR 9x5, Next Business Day (ThinkPlus part number 41C9194) • 4-year LOR 9x5, 4 hour response (ThinkPlus part number 41C9195) • 4-year LOR 24x7, 4 hour response (ThinkPlus part number 41C9196) ⇨ ThinkPlus services at lenovo.com/thinkplus/warranty ⇨ Post warranty maintenance services available ⇨ 24 hour x 7 day¹⁴ toll-free support during the warranty period¹ </td> </tr> </table>																	Preloaded operating system²⁰ - Microsoft® Windows® Vista® Business Edition (32-bit) ♦ Vista Premium logo Preloaded applications⁵ • Rescue and Recovery™ • Client Security Solution™ • ThinkVantage Productivity Center • ThinkVantage System Update • ThinkVantage Power Manager • Norton Internet Security™ (90 days of virus definitions) • Diskeeper® Home • PC-Doctor™ (diagnostics) • Adobe® Reader • Windows Live™ Toolbar • Windows Live Search • Picasa from Google • Microsoft Office 2007 Trial (60-day) • Sonic RecordNow and Drive Letter Access (DVD±RW) • Corel® WinDVD® (DVD, DVD±RW)	Accessories 1GB PC3-8500 DDR3 UDIMM 45J5434 2GB PC3-8500 DDR3 UDIMM 45J5435 500GB SATA 3.0Gb/s Disk (7200 rpm) 43R1990 1TB SATA 3.0Gb/s Disk (7200 rpm) 45J7918 USB 2.0 Lenovo Multimedia Headset 40Y8518 USB 2.0 Lenovo Webcam 40Y8519 USB 2.0 Essential Memory Key 32GB 45K1258 USB 2.0 Ultra Secure Memory Key 8GB 45J5918 USB 2.0 Portable Secure 320GB Hard Disk 43R2019 USB 2.0 Super Multi-Burner Drive 41N5565 Blu-ray Burner / HD-DVD Player SATA Drive 43R1958 ThinkVision® L2440x Wide 24" Monitor 4421HB2 Wireless Kbd & Opt Wheel Mouse (via USB) 73P4067 Lenovo USB Fingerprint Keyboard 73P4730 Laser Tilt Wheel Mouse (USB, PS/2) 41U3074 Kensington Cable Lock from Lenovo 73P2582 Kensington Twin Head Cable Lock 45K1620 ATI Radeon HD 3470 256MB (DP, VGA) 45K1636 NVIDIA® GeForce® 9500GT 512MB (DP, DVI) 45K1635 NVIDIA Quadro® 256MB FX 370 43R1766 NVIDIA Quadro 512MB FX 1700 43R1767 Acc Guide in pdf lenovo.com/accessoriesguide Other accessories at lenovo.com/accessories	Supports ThinkVantage® technologies EPEAT™ Gold rating ENERGY STAR 4.0-compliant GREENGUARD® certified RoHS-compliant Limited Warranty¹ ⇨ 3-year parts and labor ⇨ International Warranty Service® ⇨ Customer Replaceable Unit (CRU) parts only (with limited onsite service for selected parts ³ , 8 am - 5 pm, Mon - Fri coverage excluding holidays, next business day response time) ⇨ Onsite service upgrade options (in eligible locations): ⁷ • 3-year LOR 9x5, 4 hour response (ThinkPlus™ part number 41C9192) • 3-year LOR 24x7, 4 hour response (ThinkPlus part number 41C9193) • 4-year LOR 9x5, Next Business Day (ThinkPlus part number 41C9194) • 4-year LOR 9x5, 4 hour response (ThinkPlus part number 41C9195) • 4-year LOR 24x7, 4 hour response (ThinkPlus part number 41C9196) ⇨ ThinkPlus services at lenovo.com/thinkplus/warranty ⇨ Post warranty maintenance services available ⇨ 24 hour x 7 day ¹⁴ toll-free support during the warranty period ¹
Preloaded operating system²⁰ - Microsoft® Windows® Vista® Business Edition (32-bit) ♦ Vista Premium logo Preloaded applications⁵ • Rescue and Recovery™ • Client Security Solution™ • ThinkVantage Productivity Center • ThinkVantage System Update • ThinkVantage Power Manager • Norton Internet Security™ (90 days of virus definitions) • Diskeeper® Home • PC-Doctor™ (diagnostics) • Adobe® Reader • Windows Live™ Toolbar • Windows Live Search • Picasa from Google • Microsoft Office 2007 Trial (60-day) • Sonic RecordNow and Drive Letter Access (DVD±RW) • Corel® WinDVD® (DVD, DVD±RW)	Accessories 1GB PC3-8500 DDR3 UDIMM 45J5434 2GB PC3-8500 DDR3 UDIMM 45J5435 500GB SATA 3.0Gb/s Disk (7200 rpm) 43R1990 1TB SATA 3.0Gb/s Disk (7200 rpm) 45J7918 USB 2.0 Lenovo Multimedia Headset 40Y8518 USB 2.0 Lenovo Webcam 40Y8519 USB 2.0 Essential Memory Key 32GB 45K1258 USB 2.0 Ultra Secure Memory Key 8GB 45J5918 USB 2.0 Portable Secure 320GB Hard Disk 43R2019 USB 2.0 Super Multi-Burner Drive 41N5565 Blu-ray Burner / HD-DVD Player SATA Drive 43R1958 ThinkVision® L2440x Wide 24" Monitor 4421HB2 Wireless Kbd & Opt Wheel Mouse (via USB) 73P4067 Lenovo USB Fingerprint Keyboard 73P4730 Laser Tilt Wheel Mouse (USB, PS/2) 41U3074 Kensington Cable Lock from Lenovo 73P2582 Kensington Twin Head Cable Lock 45K1620 ATI Radeon HD 3470 256MB (DP, VGA) 45K1636 NVIDIA® GeForce® 9500GT 512MB (DP, DVI) 45K1635 NVIDIA Quadro® 256MB FX 370 43R1766 NVIDIA Quadro 512MB FX 1700 43R1767 Acc Guide in pdf lenovo.com/accessoriesguide Other accessories at lenovo.com/accessories	Supports ThinkVantage® technologies EPEAT™ Gold rating ENERGY STAR 4.0-compliant GREENGUARD® certified RoHS-compliant Limited Warranty¹ ⇨ 3-year parts and labor ⇨ International Warranty Service® ⇨ Customer Replaceable Unit (CRU) parts only (with limited onsite service for selected parts ³ , 8 am - 5 pm, Mon - Fri coverage excluding holidays, next business day response time) ⇨ Onsite service upgrade options (in eligible locations): ⁷ • 3-year LOR 9x5, 4 hour response (ThinkPlus™ part number 41C9192) • 3-year LOR 24x7, 4 hour response (ThinkPlus part number 41C9193) • 4-year LOR 9x5, Next Business Day (ThinkPlus part number 41C9194) • 4-year LOR 9x5, 4 hour response (ThinkPlus part number 41C9195) • 4-year LOR 24x7, 4 hour response (ThinkPlus part number 41C9196) ⇨ ThinkPlus services at lenovo.com/thinkplus/warranty ⇨ Post warranty maintenance services available ⇨ 24 hour x 7 day ¹⁴ toll-free support during the warranty period ¹																	

See footnotes for important warranty information
 US models announced October 21, 2008

Name	Type-model	Slot x bay	Processor	GHz	Cores	Memory ³	SATA disk	SATA optical	Graphics	Monitor connectors	DisplayPort dongle	Intel vPro	Vista preload	Global (G) GMP (P)	Avail date
M58p	6138-A1U	4x4	Core 2 Duo E8400	3.00	2	2GB	160GB ²	DVD±RW	GMA	VGA, DP	None	vPro	Bus32	G P	Nov 08

- **Intel Core 2 Processor with vPro™ Technology (includes Intel Active Management Technology)**
- **This model is part of the Global Models Plus (GMP) program with limited onsite service³ 3-year limited warranty**

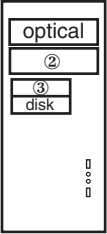
Positioning Processor	<i>Ultimate stability/manageability for large enterprise and mid-market</i>										<p>Tower</p> <ul style="list-style-type: none"> • Business black color; metal case • 6.9" W X 17.3" D X 15.8" H • 175mm W X 440mm D X 402mm H • 24.2 lb (11.0 kg) in max configuration • Handle on top front • Toolless cover removal • Toolless disk, diskette drive, optical drive removal • Toolless adapter retention 	
Implementation	Processor in FC-LGA8 package in LGA775 socket											
Memory	2GB std, 8GB max⁶, PC3-8500 1066MHz DDR3 , non-parity, dual-channel capable, four 240-pin DIMM sockets; <i>Italics:</i> standard memory in two sockets; two sockets available										<p>Bay ① 5.25", 1.6" high, access, std optical</p> <p>Bay ② 5.25", 1.6" high, access, open</p> <p>Bay ③ 3.5", 1" high, access, open (reader/diskette)</p> <p>Bay ④ 3.5", 1" high, no access, std disk</p>	
Graphics	Intel Graphics Media Accelerator 4500 (GMA 4500) , integrated graphics in Q45, uses main memory (up to 765MB), one analog VGA DB-15 connector, one DisplayPort™ connector (supports single-link DVI-D via cable 45J7915), HDCP, DirectX® 10, supports dual independent display											
SATA disk	160GB , SATA 3.0Gb/s 7200 rpm, vibration dampening mounts										<p>Slot 1: half-length, full-height, PCIe 2.0 x16 (75w max)</p> <p>Slot 2: half-length, full-height, PCIe x1</p> <p>Slot 3: half-length, full-height, 32-bit PCI 2.3</p> <p>Slot 4: half-length, full-height, 32-bit PCI 2.3</p>	
SATA controller	Serial ATA, SATA 3.0Gb/s, integrated in ICH10DO, RAID 0/1											
SATA DVD±RW	Multi-Burner DL DVD±RW SATA 1.5Gb/s Drive (41N5620)											
SATA cables	Two SATA cables (each 1-drop to device), three SATA connectors and one eSATA connector on planar											
eSATA port	None											
Diskette drive	None											
Media reader	None											
Chipset	Intel Q45 Express Chipset (PCI Express® 2.0 x16), I/O Controller Hub 10 Digital Office [ICH10DO] (SATA 3.0Gb/s with RAID 0/1 support, PCI Express x1, ethernet MAC, PCI 2.3, USB, LPC bus), SMSC® SCH5617 Super I/O										<p>Security</p> <ul style="list-style-type: none"> • Security chip (see information on left) • One lock to secure both cover and entire system to fixed object: <ul style="list-style-type: none"> - Padlock loop (in rear for opt padlock) - Security slot (in rear for optional Kensington® Microsaver® cable) • Power-on password • Administrator password • Hard disk password (user and master) • Boot sequence control • Boot without diskette, keyboard • Serial port I/O control • Individual USB port disablement • Chassis intrusion switch 	
Front ports	Two USB 2.0, microphone (stereo, 3.5mm), headphone (stereo, 3.5mm)											
Rear ports	Six USB 2.0, serial (9-pin), keyboard (PS/2), mouse (PS/2), ethernet (RJ-45), monitor (VGA DB-15, DisplayPort)											
Internal connector	Two USB 2.0 planar conn (1 used; one open for media reader or 2 rear USB ports)											
Rear audio ports	Line-in (stereo, 3.5mm), line-out (stereo, 3.5mm), microphone-in (stereo, 3.5mm)											
Audio	High Definition (HD) Audio, Analog Devices AD1882 codec											
Speaker	One internal speaker for business audio											
Ethernet	Gigabit ethernet on planar, Intel 82567LM, Wake on LAN®, ASF2.0, DASH 1.0											
Intel AMT	Intel Active Management Technology (iAMT)											
Modem	None											
Security chip	Winbond® WPCT200 SafeKeeper™ Trusted Platform Module, TCG 1.2-compliant											
Keyboard	Preferred Pro USB Keyboard (USB connector), 104-key, black, Lenovo logo											
Mouse	Optical Wheel Mouse (USB connector), black, Lenovo logo											
Power supply	280 watts with variable speed fan, manual switch, two diagnostic LEDs											
Preloaded operating system²⁰	Accessories										<p>Supports ThinkVantage® technologies</p> <p>GREENGUARD® certified</p> <p>RoHS-compliant</p>	
- Microsoft® Windows® Vista® Business Edition (32-bit)	1GB PC3-8500 DDR3 UDIMM 45J5434											
◇ Vista Premium logo	2GB PC3-8500 DDR3 UDIMM 45J5435											
Preloaded applications⁵	500GB SATA 3.0Gb/s Disk (7200 rpm) 43R1990											
• Rescue and Recovery™	1TB SATA 3.0Gb/s Disk (7200 rpm) 45J7918											
• Client Security Solution™	USB Portable Diskette Drive 05K9276											
• ThinkVantage Productivity Center	USB 2.0 Lenovo Multimedia Headset 40Y8518											
• ThinkVantage System Update	USB 2.0 Lenovo Webcam 40Y8519											
• ThinkVantage Power Manager	USB 2.0 Essential Memory Key 32GB 45K1258											
• Norton Internet Security™ (90 days of virus definitions)	USB 2.0 Ultra Secure Memory Key 2GB 45J5916											
• Diskeeper® Home	USB 2.0 Ultra Secure Memory Key 4GB 45J5917											
• PC-Doctor™ (diagnostics)	USB 2.0 Ultra Secure Memory Key 8GB 45J5918											
• Adobe® Reader	USB 2.0 Portable 160GB Hard Disk 43R1784											
• Windows Live™ Toolbar	USB 2.0 Portable Secure 320GB Hard Disk 43R2019											
• Windows Live Search	Blu-ray Burner / HD-DVD Player SATA Drive 43R1958											
• Picasa from Google	ThinkVision® L2440x Wide 24" Monitor 4421HB2											
• Microsoft Office 2007 Trial (60-day)	DisplayPort to Single-link DVI-D Cable 45J7915											
• Sonic RecordNow and Drive Letter Access (DVD±RW)	Wireless Kbd & Opt Wheel Mouse (via USB) 73P4067											
• Corel® WinDVD® (DVD±RW)	Lenovo USB Fingerprint Keyboard 73P4730											
	Laser Tilt Wheel Mouse (USB, PS/2) 41U3074											
	Kensington Cable Lock from Lenovo 73P2582											
	Kensington Twin Head Cable Lock 45K1620											
	ATI™ Radeon™ HD 3470 256MB (DP, VGA) 45K1636											
	NVIDIA® GeForce® 9500GT 512MB (DP, DVI) 45K1635											
	NVIDIA Quadro® 256MB FX 370 43R1766											
	NVIDIA Quadro 512MB FX 1700 43R1767											
	Acc Guide in pdf lenovo.com/accessoriesguide											
	Other accessories at lenovo.com/accessories											
	Limited Warranty ¹											
	<ul style="list-style-type: none"> ↔ 3-year parts and labor ↔ International Warranty Service⁹ ↔ Customer Replaceable Unit (CRU) parts only (with limited onsite service for selected parts³, 8 am - 5 pm, Mon - Fri coverage excluding holidays, next business day response time) ↔ Onsite service upgrade options (in eligible locations):⁷ <ul style="list-style-type: none"> • 4-year LOR 9x5, Next Business Day (ThinkPlus part number 41C9194) • 4-year LOR 9x5, 4 hour response (ThinkPlus part number 41C9195) • 4-year LOR 24x7, 4 hour response (ThinkPlus part number 41C9196) ↔ ThinkPlus services at lenovo.com/thinkplus/warranty ↔ Post warranty maintenance services available ↔ 24 hour x 7 day¹⁴ toll-free support during the warranty period¹ via 800-426-7378 											

See footnotes for important warranty information
US model announced October 21, 2008

ThinkCentre® M58p Tower (6209) - ENERGY STAR® 4.0 (GMP)

Personal Systems Reference (PSREF)

Name	Type-model	Slot x bay	Processor	GHz	Cores	Memory ^a	SATA disk	SATA optical	Graphics	Monitor conn	DisplayPort dongle	ENERGY STAR 4.0	Intel vPro	Vista preload	Global (G) GMP (P)	Avail date
M58p	6209-A1U	4x4	Core 2 Duo E8400	3.00	2	2GB	160GB ²	DVD±RW	GMA	VGA, DP	None	ES40	vPro	Bus32	G P	Nov 08

- **Intel Core 2 Processor with vPro™ Technology (includes Intel Active Management Technology)**
- **This model is part of the Global Models Plus (GMP) program with limited onsite service³ 3-year limited warranty**

Positioning Processor	<i>Ultimate stability/manageability for large enterprise and mid-market</i>										Tower		
Implementation	Intel® Core™ 2 Duo Processor E8400 with dual-core, Virtualization Technology, TXT, 1333MHz system bus, and 6MB L2 cache Processor in FC-LGA8 package in LGA775 socket										<ul style="list-style-type: none"> • Business black color; metal case • 6.9" W X 17.3" D X 15.8" H • 175mm W X 440mm D X 402mm H • 24.2 lb (11.0 kg) in max configuration • Handle on top front • Toolless cover removal • Toolless disk, diskette drive, optical drive removal • Toolless adapter retention 		
Memory	2GB std, 8GB max^a, PC3-8500 1066MHz DDR3 , non-parity, dual-channel capable, four 240-pin DIMM sockets; <i>Italics:</i> standard memory in two sockets; two sockets available										Bay ① 5.25", 1.6" high, access, std optical Bay ② 5.25", 1.6" high, access, open Bay ③ 3.5", 1" high, access, open (reader/diskette) Bay ④ 3.5", 1" high, no access, std disk		
Graphics	Intel Graphics Media Accelerator 4500 (GMA 4500) , integrated graphics in Q45, uses main memory (up to 765MB), one analog VGA DB-15 connector, one DisplayPort™ connector (supports single-link DVI-D via cable 45J7915), HDCP, DirectX® 10, supports dual independent display										Slot 1: half-length, full-height, PCIe 2.0 x16 (75w max) Slot 2: half-length, full-height, PCIe x1 Slot 3: half-length, full-height, 32-bit PCI 2.3 Slot 4: half-length, full-height, 32-bit PCI 2.3		
SATA disk	160GB , SATA 3.0Gb/s 7200 rpm, vibration dampening mounts Serial ATA, SATA 3.0Gb/s, integrated in ICH10DO, RAID 0/1 Super Multi-Burner DL DVD±RW SATA 1.5Gb/s Drive (41N5620) Two SATA cables (each 1-drop to device), three SATA connectors and one eSATA connector on planar										Security		
SATA controller	None										<ul style="list-style-type: none"> • Security chip (see information on left) • One lock to secure both cover and entire system to fixed object: <ul style="list-style-type: none"> - Padlock loop (in rear for opt padlock) - Security slot (in rear for optional Kensington® Microsaver® cable) • Power-on password • Administrator password • Hard disk password (user and master) • Boot sequence control • Boot without diskette, keyboard • Serial port I/O control • Individual USB port disablement • Chassis intrusion switch 		
SATA DVD±RW	None										Supports ThinkVantage® technologies		
SATA cables	None										EPEAT™ Gold rating ENERGY STAR 4.0-compliant GREENGUARD® certified RoHS-compliant		
eSATA port	None										Limited Warranty¹ <ul style="list-style-type: none"> ↔ 3-year parts and labor ↔ International Warranty Service⁹ ↔ Customer Replaceable Unit (CRU) parts only (with limited onsite service for selected LOR 24x7, 8 am - 5 pm, Mon - Fri coverage excluding holidays, next business day response time) ↔ Onsite service upgrade options (in eligible locations):⁷ <ul style="list-style-type: none"> • 4-year LOR 9x5, Next Business Day (ThinkPlus part number 41C9194) • 4-year LOR 9x5, 4 hour response (ThinkPlus part number 41C9195) • 4-year LOR 24x7, 4 hour response (ThinkPlus part number 41C9196) ↔ ThinkPlus services at lenovo.com/thinkplus/warranty ↔ Post warranty maintenance services available ↔ 24 hour x 7 day¹⁴ toll-free support during the warranty period¹ via 800-426-7378 		
Diskette drive	None										Accessories		
Media reader	None										1GB PC3-8500 DDR3 UDIMM 45J5434 2GB PC3-8500 DDR3 UDIMM 45J5435 500GB SATA 3.0Gb/s Disk (7200 rpm) 43R1990 1TB SATA 3.0Gb/s Disk (7200 rpm) 45J7918 USB Portable Diskette Drive 05K9276 USB 2.0 Lenovo Multimedia Headset 40Y8518 USB 2.0 Lenovo Webcam 40Y8519 USB 2.0 Essential Memory Key 32GB 45K1258 USB 2.0 Ultra Secure Memory Key 2GB 45J5916 USB 2.0 Ultra Secure Memory Key 4GB 45J5917 USB 2.0 Ultra Secure Memory Key 8GB 45J5918 USB 2.0 Portable 160GB Hard Disk 43R1784 USB 2.0 Portable Secure 320GB Hard Disk 43R2019 Blu-ray Burner / HD-DVD Player SATA Drive 43R1958 ThinkVision™ L2440x Wide 24" Monitor 4421HB2 DisplayPort to Single-link DVI-D Cable 45J7915 Wireless Kbd & Opt Wheel Mouse (via USB) 73P4067 Lenovo USB Fingerprint Keyboard 73P4730 Laser Tilt Wheel Mouse (USB, PS/2) 41U3074 Kensington Cable Lock from Lenovo 73P2582 Kensington Twin Head Cable Lock 45K1620 ATI™ Radeon™ HD 3470 256MB (DP, VGA) 45K1636 NVIDIA® GeForce® 9500GT 512MB (DP, DVI) 45K1635 NVIDIA Quadro® 256MB FX 370 43R1766 NVIDIA Quadro 512MB FX 1700 43R1767 Acc Guide in pdf lenovo.com/accessoriesguide Other accessories at lenovo.com/accessories		
Chipset	Intel Q45 Express Chipset (PCI Express® 2.0 x16), I/O Controller Hub 10 Digital Office [ICH10DO] (SATA 3.0Gb/s with RAID 0/1 support, PCI Express x1, ethernet MAC, PCI 2.3, USB, LPC bus), SMSC® SCH5617 Super I/O										Preloaded operating system ²⁰		
Front ports	Two USB 2.0, microphone (stereo, 3.5mm), headphone (stereo, 3.5mm)										- Microsoft® Windows® Vista® Business Edition (32-bit) ♦ Vista Premium logo		
Rear ports	Six USB 2.0, serial (9-pin), keyboard (PS/2), mouse (PS/2), ethernet (RJ-45), monitor (VGA DB-15, DisplayPort)										Preloaded applications ⁵ <ul style="list-style-type: none"> • Rescue and Recovery™ • Client Security Solution™ • ThinkVantage Productivity Center • ThinkVantage System Update • ThinkVantage Power Manager • Norton Internet Security™ (90 days of virus definitions) • Diskeeper® Home • PC-Doctor™ (diagnostics) • Adobe® Reader • Windows Live™ Toolbar • Windows Live Search • Picasa from Google • Microsoft Office 2007 Trial (60-day) • Sonic RecordNow and Drive Letter Access (DVD±RW) • Corel® WinDVD® (DVD±RW) 		
Internal connector	Two USB 2.0 planar conn (1 used; one open for media reader or 2 rear USB ports)										Keyboard Preferred Pro USB Keyboard (USB connector), 104-key, black, Lenovo logo Mouse Optical Wheel Mouse (USB connector), black, Lenovo logo Power supply 280 watts with variable speed fan, autosensing, two diagnostic LEDs, 80% PSU		
Rear audio ports	Line-in (stereo, 3.5mm), line-out (stereo, 3.5mm), microphone-in (stereo, 3.5mm)										Security chip Winbond® WPCT200 SafeKeeper™ Trusted Platform Module, TCG 1.2-compliant		
Audio	High Definition (HD) Audio, Analog Devices AD1882 codec										Preloaded operating system ²⁰		
Speaker	One internal speaker for business audio										♦ Vista Premium logo		
Ethernet	Gigabit ethernet on planar, Intel 82567LM, Wake on LAN®, ASF2.0, DASH 1.0										Preloaded applications ⁵		
Intel AMT	Intel Active Management Technology (iAMT)										• Rescue and Recovery™		
Modem	None										• Client Security Solution™		
Security chip	Winbond® WPCT200 SafeKeeper™ Trusted Platform Module, TCG 1.2-compliant										• ThinkVantage Productivity Center		
Keyboard	Preferred Pro USB Keyboard (USB connector), 104-key, black, Lenovo logo										• ThinkVantage System Update		
Mouse	Optical Wheel Mouse (USB connector), black, Lenovo logo										• ThinkVantage Power Manager		
Power supply	280 watts with variable speed fan, autosensing, two diagnostic LEDs, 80% PSU										• Norton Internet Security™ (90 days of virus definitions)		
											• Diskeeper® Home		
											• PC-Doctor™ (diagnostics)		
											• Adobe® Reader		
											• Windows Live™ Toolbar		
											• Windows Live Search		
											• Picasa from Google		
											• Microsoft Office 2007 Trial (60-day)		
											• Sonic RecordNow and Drive Letter Access (DVD±RW)		
											• Corel® WinDVD® (DVD±RW)		

See footnotes for important warranty information
 US model announced October 21, 2008

© Lenovo
 (MLAN1-15) November 2008

Partial list of accessories supported on ThinkCentre M58 and M58p**Memory**

Eco Ultra Small 8820/7359/9961/7479/6136 use notebook memory:
 1GB PC3-8500 DDR3 SODIMM (notebook) 43R1987 *ann 08/05/08*
 2GB PC3-8500 DDR3 SODIMM (notebook) 43R1988 *ann 08/05/08*

Small 8910/7360/6258/9964/7483/7220/6137/6234, and Tower 9960/7373/6239/9965/7484/7188/6138/6209 use desktop memory:

1GB PC3-8500 DDR3 UDIMM 45J5434 *ann 11/18/08*
 2GB PC3-8500 DDR3 UDIMM 45J5435 *ann 11/18/08*

Optical

All:
 DVD-ROM DL SATA 1.5Gb/s 16X-48X Max⁴ 41N5618 *ann 09/26/06*
 Super Multi-Burner DL DVD±RW SATA Drive 41N5620 *ann 09/26/06*

Tower 9960/7373/6239/9965/7484/7188/6138/6209 support:
 Blu-ray Burner / HD-DVD Player SATA Drive 43R1958 *ann 12/18/07*

Storage and removable storage

80GB SATA 3.0Gb/s Disk (7200 rpm) 09N4253 *ann 05/19/03*
 160GB SATA 3.0Gb/s Disk (7200 rpm) 09N4254 *ann 05/19/03*
 250GB SATA 3.0Gb/s Disk (7200 rpm) 41N3015 *ann 01/24/06*
 500GB SATA 3.0Gb/s Disk (7200 rpm) 43R1990 *ann 11/06/07*
 1TB SATA 3.0Gb/s Disk (7200 rpm) 45J7918 *ann 08/19/08*

USB Portable Diskette Drive 05K9276 *ann 06/05/00*
 USB 2.0 Essential Memory Key 1GB 41U4940 *ann 01/23/07*
 USB 2.0 Essential Memory Key 2GB 41U4944 *ann 01/23/07*
 USB 2.0 Essential Memory Key 4GB 45J7904 *ann 06/24/08*
 USB 2.0 Essential Memory Key 8GB 45J7905 *ann 07/15/08*
 USB 2.0 Essential Memory Key 32GB 45K1258 *ann 10/28/08*
 USB 2.0 Security Memory Key 1GB 41U5118 *ann 07/17/07*
 USB 2.0 Security Memory Key 2GB 41U5119 *ann 07/17/07*
 USB 2.0 Security Memory Key 4GB 41U5120 *ann 07/17/07*
 USB 2.0 Ultra Secure Memory Key 1GB 45J5915 *ann 08/26/08*
 USB 2.0 Ultra Secure Memory Key 2GB 45J5916 *ann 08/26/08*
 USB 2.0 Ultra Secure Memory Key 4GB 45J5917 *ann 08/26/08*
 USB 2.0 Ultra Secure Memory Key 8GB 45J5918 *ann 08/26/08*
 USB 2.0 Portable 160GB Hard Disk 43R1784 *ann 09/23/08*
 USB 2.0 Portable Secure 160GB Hard Disk 43R2018 *ann 11/18/08*
 USB 2.0 Portable Secure 320GB Hard Disk 43R2019 *ann 11/18/08*
 USB 2.0 CD-RW/DVD-ROM Combo II Drive 40Y8637 *ann 01/05/06*
 USB 2.0 Super Multi-Burner Drive 41N5565 *ann 01/23/07*

Graphics

Small 8910/7360/6258/7638/9964/7483/7220/6137/6234 support Low Profile:

ATI™ Radeon™ HD 3470 256MB (DP, VGA) 45K1636 *ann 11/18/08*
Tower 9960/7373/6239/9965/7484/7188/6138/6209 support 75 watts max:
 ATI Radeon HD 3470 256MB (DP, VGA) 45K1636 *ann 11/18/08*
 NVIDIA® GeForce® 9500 GT 512MB (DP, DVI) 45K1635 *ann 11/18/08*
 NVIDIA Quadro® 256MB FX 370 43R1766 *ann 12/18/07*
 NVIDIA Quadro 512MB FX 1700 43R1767 *ann 12/18/07*

More information at www.lenovo.com/support/graphiccards

Keyboard

Preferred Pro USB Keyboard 73P5220 *ann 06/21/05*
 Preferred Pro Full Size PS/2 Keyboard 31P7415 *ann 06/04/02*
 Enhanced Performance USB Keyboard 73P2620 *ann 03/23/04*
 Wireless Kbd & Opt Wheel Mouse (via USB) 73P4067 *ann 12/07/04*
 USB Travel Keyboard with UltraNav™ 31P9490 *ann 04/27/04*
 Lenovo USB Fingerprint Keyboard 73P4730 *ann 02/22/05*

More information at www.lenovo.com/support/keyboards

Mouse

Optical Wheel Mouse (USB) 06P4069 *ann 05/21/03*
 Optical ScrollPoint® Mouse (USB, PS/2) 31P7405 *ann 08/27/02*
 Laser Tilt Wheel Mouse (USB, PS/2) 41U3074 *ann 01/23/07*
 Lenovo Wireless Laser Mouse (blk, via USB) 45K1696 *ann 11/25/08*
 Lenovo Wireless Laser Mouse (red, via USB) 51J0198 *ann 11/25/08*

More information at www.lenovo.com/support/mice

Multimedia

USB 2.0 Lenovo Multimedia Headset 40Y8518 *ann 06/27/06*
 USB 2.0 Lenovo Webcam 40Y8519 *ann 08/29/06*

Security

Kensington® Cable Lock from Lenovo 73P2582 *ann 12/29/03*
 Kensington Twin Head Cable Lock 45K1620 *ann 09/30/08*
 USB Gemplus GemPC Smart Card Reader 41N3040 *ann 02/21/06*

Mounting Device

Eco Ultra Small 8820/7359/9961/7479/6136 support under desk mounting device:
 ThinkCentre Ultra Small Under Desk Mount 40Y8625 *ann 09/06/05*

Monitors

ThinkVision® L174 17" Monitor 9227AE1 *ann 04/15/08*
 ThinkVision L1700p 17" Monitor 9417HE2 *ann 09/17/08*
 ThinkVision L1900p 19" Monitor 4431HE1 *ann 11/11/08*
 ThinkVision L1940p Wide 19" Monitor 4424HB6 *ann 09/17/08*
 ThinkVision L200p Wide 20.1" Monitor 4438HB6 *ann 04/15/08*
 ThinkVision L2240p Wide 22" Monitor 4422HB6 *ann 09/17/08*
 ThinkVision L2440p Wide 24" Monitor 4420HB2 *ann 09/17/08*
 ThinkVision L2440x Wide 24" Monitor 4421HB2 *ann 09/17/08*

More information at www.lenovo.com/thinkvision

Monitor Accessories⁴⁶

DisplayPort to Single-link DVI-D Cable 45J7915 *ann 08/05/08*
 ThinkVision USB Soundbar 40Y7616 *ann 08/23/05*
 ThinkVision Soundbar (L1900p, 24" Wide) 45K1263 *ann 09/16/08*
 Kensington Cable Lock from Lenovo 73P2582 *ann 12/29/03*
 Kensington Twin Head Cable Lock 45K1620 *ann 09/30/08*
 Radial Arm 19K4464 *ann 05/05/00*

⁴⁶Compatible on selected Lenovo and ThinkVision monitors.

More information at www.lenovo.com/support/monitoraccessories

Medialess License Key (MLK)

Microsoft® Office 2007 Basic, English 43R1528 *ann 01/31/07*
 Microsoft Office 2007 Small Business, Engl 43R1534 *ann 01/31/07*
 Microsoft Office 2007 Professional, English 43R1531 *ann 01/31/07*

Other accessories at www.lenovo.com/accessories

Accessories Guide pdf at www.lenovo.com/accessoriesguide

Lenovo ThinkCentre A57 Small (9704) and Tower (9702)



Lenovo ThinkCentre A57 Small



Lenovo ThinkCentre A57 Small



Lenovo ThinkCentre A57 Small



Lenovo ThinkCentre A57 Small
with dual Lenovo ThinkVision monitors



Lenovo ThinkCentre A57 Tower



Lenovo ThinkCentre A57 Tower

ThinkCentre® A57 Small (9704) - TopSeller

Personal Systems Reference (PSREF)

Name	Type-model	Slot x bay	Processor	GHz	L2 cache	Core	Memory ⁸	SATA disk	SATA optical	Graphics	Preload	Limited warranty ¹	Global Educ	Avail date
A57	9704-ALU	2x3	Pentium E2180	2.00	1MB	Dual	512MB	80GB ²	DVD	GMA	XP Pro	1-yr	None	Mar 08
A57	9704-AMU	2x3	Pentium E2180	2.00	1MB	Dual	512MB	160GB	Combo	GMA	XP Pro	1-yr	None	Mar 08
A57	9704-ANU	2x3	Pentium E2180	2.00	1MB	Dual	1GB	160GB	DVD±RW	GMA	XP Pro	1-yr	None	Mar 08
A57	9704-APU	2x3	Pentium E2200	2.20	1MB	Dual	1GB	160GB	Combo	GMA	XP Pro	1-yr	None	Mar 08
A57	9704-BDU	2x3	Pentium E2200	2.20	1MB	Dual	2GB	160GB	DVD±RW	GMA	XP Pro	1-yr	None	Mar 08

• **These small and medium business (SMB) models are part of the US TopSeller™ Program**

Positioning Processor	Quality, reliability, and security for small/medium businesses Intel® Pentium® Dual-Core Processor E2180 or E2200 with dual-core, Intel 64 Technology, Execute Disable Bit, EIST, and 800MHz system bus with 1MB shared L2 cache Processor in FC-LGA6 package in LGA775 socket		Small	
Implementation			Bay ① 5.25", 1.6" high, access, std optical Bay ② 3.5", 1" high, no access, std disk Bay ③ 3.5", .5" high, access, open (reader/diskette)	
Memory	512MB, 1GB, or 2GB std , 4GB max ⁸ , PC2-5300 667MHz DDR2 , non-parity, dual-channel capable, two 240-pin DIMM sockets; <i>Italics:</i> standard memory in both sockets; no sockets avail; <i>Non-italics:</i> standard memory in one socket; one socket available		Slot 1: Low Profile, PCI Express x16 (35w max) Slot 2: Low Profile, 32-bit PCI 2.3	
Graphics	Intel Graphics Media Accelerator 3100 (GMA 3100) , integrated graphics in G31, uses main memory (up to 256MB), one analog VGA DB-15 connector, supports dual independent display with optional ADD2 adapter		<ul style="list-style-type: none"> Business black color; metal case 12.5" W X 14.0" D X 3.9" H 317mm W X 355mm D X 99mm H 16.1 lb (7.3 kg) in maximum configuration Bays 1, 2, 3 flip up (latched and pivoting) Toolless cover flips up and tilts backward on rear hinges Toolless disk, diskette drive, optical drive removal Toolless adapter retention Toolless systemboard retention Steel chassis supports 100 lb (45kg) monitor on top System floor stand for vertical orientation 	
SATA disk	80GB or 160GB , SATA 3.0Gb/s 7200 rpm, vibration dampening			
SATA controller	Serial ATA, SATA 3.0Gb/s, integrated in ICH7			
SATA DVD	<i>Some:</i> DVD-ROM DL SATA 1.5Gb/s 16-48X Max ⁴ Drive (41N5618)			
SATA Combo	<i>Some:</i> CD-RW/DVD-ROM Combo SATA 1.5Gb/s Drive			
SATA DVD±RW	<i>Some:</i> Super Multi-Burner DL DVD±RW SATA Drive (41N5620)			
SATA cables	Two SATA cables (each 1-drop to device), two SATA connectors			
eSATA port	None			
EIDE controller	Enhanced IDE, ATA-100, integrated in ICH7, one EIDE connector on planar			
Diskette drive	None			
Media reader	None			
Chipset	Intel G31 Express Chipset ; I/O Controller Hub 7 (ICH7) for SATA 3.0Gb/s, ATA-100 EIDE, PCI Express [®] x1, PCI 2.3, USB, LPC bus / ITE Tech [®] IT8718 Super I/O for serial, parallel, keyboard, mouse functions			
Front ports	Two USB 2.0, microphone (stereo, 3.5mm), headphone (stereo, 3.5mm)			
Rear ports	Four USB 2.0, serial (9-pin), parallel (25-pin), keyboard (PS/2), mouse (PS/2), ethernet (RJ-45), monitor (VGA DB-15)			
Internal connector	Two USB 2.0 planar connectors (one used; one open for media reader)			
Rear audio ports	Line-in (stereo, 3.5mm), line-out (stereo, 3.5mm), microphone (stereo, 3.5mm)			
Audio	High Definition (HD) Audio, Realtek [®] ALC662 codec			
Speaker	One internal speaker for business audio			
Ethernet	Gigabit ethernet on planar, Marvell [®] 88E8056, PCIe x1, Wake on LAN [®]			
Intel AMT	None			
Modem	None			
Security chip	None			
Keyboard	Preferred Pro USB Keyboard (USB connector), 104-key, black, Lenovo logo			
Mouse	Optical Wheel Mouse (USB connector), 400 dpi, black, Lenovo logo			
Power supply	280 watts with variable speed fan, autosensing			
Preloaded operating system²⁰	- Microsoft [®] Windows [®] XP Professional with Vista [®] COA ◇ Disk-to-Disk Recovery (in hidden protected area)			
Preloaded applications⁵	<ul style="list-style-type: none"> Rescue and Recovery™ Client Security Solution™ ThinkVantage Productivity Center ThinkVantage System Update System Migration Assistant Norton Internet Security™ (90 days of virus definitions) Diskeeper[®] Home PC-Doctor™ (diagnostics) Adobe[®] Reader Windows Live™ Toolbar Windows Live Search Picasa from Google Microsoft Office 2007 Trial (60-day) Multimedia Center for Think Offerings (combo, DVD, DVD±RW) Sonic RecordNow and Drive Letter Access (combo, DVD±RW) Corel[®] WinDVD[®] (combo, DVD, DVD±RW) Corel WinDVD Creator (DVD±RW) 			
Accessories	<ul style="list-style-type: none"> 1GB PC2-5300 DDR2 UDIMM (TopSeller) 43R2001 2GB PC2-5300 DDR2 UDIMM (TopSeller) 43R2002 250GB SATA 3.0Gb/s Disk (7200 rpm) 41N3015 500GB SATA 3.0Gb/s Disk (7200 rpm) 41R1990 USB Portable Diskette Drive 05K9276 USB 2.0 Lenovo Multimedia Headset 40Y8518 USB 2.0 Lenovo Webcam 40Y8519 USB 2.0 Essential Memory Key 32GB 45K1258 USB 2.0 Ultra Secure Memory Key 2GB 45J5916 USB 2.0 Ultra Secure Memory Key 4GB 45J5917 USB 2.0 Ultra Secure Memory Key 8GB 45J5918 USB 2.0 Portable 160GB Hard Disk 43R1784 USB 2.0 Portable Secure 320GB Hard Disk 43R2019 USB 2.0 Super Multi-Burner Drive 41N5565 ThinkVision[®] L1700p 17" Monitor 9417HE2 ThinkVision L1940p Wide 19" Monitor 4424HB6 ThinkVision L2240p Wide 22" Monitor 4422HB6 ThinkVision L2440p Wide 24" Monitor 4420HB2 Wireless Kbd & Opt Wheel Mouse (via USB) 73P4067 Laser Tilt Wheel Mouse (USB, PS/2) 41U3074 Kensington Cable Lock from Lenovo 73P2582 ADD2 DVI-I PCIe Connection Adapter 73P2516 ADD2 DVI-D Monitor Connection (HDCP) 43R1985 ATI[™] Radeon[™] HD 2400 Pro 128MB 43R1961 ATI Radeon HD 2400 XT 256MB 43R1962 Acc Guide in pdf lenovo.com/accessoriesguide Other accessories at lenovo.com/accessories 			
			Supports ThinkVantage [®] technologies	
			RoHS-compliant	
			Limited Warranty¹	
			<ul style="list-style-type: none"> 1-year parts and labor International Warranty Service⁹ Customer Replaceable Unit (CRU) parts only (with limited onsite service for selected parts³, 8 am - 5 pm, Mon - Fri coverage excluding holidays, next business day response time) Onsite service upgrade options (in eligible locations):⁷ <ul style="list-style-type: none"> 1-year LOR 9x5, 4 hour response (ThinkPlus™ part number 41C9189) 2-year LOR 9x5, Next Business Day (ThinkPlus part number 41C9187) 2-year LOR 9x5, 4 hour response (4422HB6 part number 41C9190) 3-year LOR 9x5, Next Business Day (ThinkPlus part number 41C9188) 3-year LOR 9x5, 4 hour response (ThinkPlus part number 41C9191) ThinkPlus services at lenovo.com/thinkplus/warranty Post warranty maintenance services available 24 hour x 7 day¹⁴ toll-free support during the warranty period¹ via 800-426-7378 	

See footnotes for important warranty information
US models announced February 26, 2008

© Lenovo
(TUNS1-1) March 2008

Name	Type-model	Slot x bay	Processor	GHz	Cores	Memory ⁸	SATA disk	SATA optical	Graphics	Preload	Vista logo	Limited warranty ¹	Global Educ	Avail date
A57	9704-B5U	2x3	Pentium E2200	2.20	2	512MB	160GB ²	DVD	GMA	XP Pro	Basic	1-yr	None	Nov 08
A57	9704-B6U	2x3	Pentium E2200	2.20	2	1GB	160GB	DVD±RW	GMA	XP Pro	Premium	1-yr	None	Nov 08

• These small and medium business (SMB) models are part of the US TopSeller™ Program

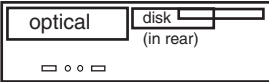
Positioning	Quality, reliability, and security for small/medium businesses		Small	
Processor	Intel® Pentium® Dual-Core Processor E2200 with dual-core, 800MHz system bus, and 1MB L2 cache			
Implementation	Processor in FC-LGA6 package in LGA775 socket			
Memory	512MB or 1GB std, 4GB max ⁸ , PC2-5300 667MHz DDR2, non-parity, dual-channel capable, two 240-pin DIMM sockets; <i>Non-italics</i> : standard memory in one socket; one socket available		Bay ① 5.25", 1.6" high, access, std optical	
Graphics	Intel Graphics Media Accelerator 3100 (GMA 3100), integrated graphics in G31, uses main memory (up to 256MB), one analog VGA DB-15 connector, supports dual independent display with optional ADD2 adapter		Bay ② 3.5", 1" high, no access, std disk	
SATA disk	160GB, SATA 3.0Gb/s 7200 rpm, vibration dampening mounts		Bay ③ 3.5", .5" high, access, open (reader/diskette)	
SATA controller	Serial ATA, SATA 3.0Gb/s, integrated in ICH7		Slot 1: Low Profile, PCI Express x16 (35w max)	
SATA DVD	<i>Some</i> : DVD-ROM DL SATA 1.5Gb/s 16-48X Max ⁴ Drive (41N5618)		Slot 2: Low Profile, 32-bit PCI 2.3	
SATA DVD±RW	<i>Some</i> : Super Multi-Burner DL DVD±RW SATA Drive (41N5620)		<ul style="list-style-type: none"> • Business black color; metal case • 12.5" W X 14.0" D X 3.9" H • 317mm W X 355mm D X 99mm H • 16.1 lb (7.3 kg) in maximum configuration • Bays 1, 2, 3 flip up (latched and pivoting) • Toolless cover flips up and tilts backward on rear hinges • Toolless disk, diskette drive, optical drive removal • Toolless adapter retention • Toolless systemboard retention • Steel chassis supports 100 lb (45kg) monitor on top • System floor stand for vertical orientation 	
SATA cables	Two SATA cables (each 1-drop to device), two SATA connectors			
eSATA port	None			
EIDE controller	Enhanced IDE, ATA-100, integrated in ICH7, one EIDE connector			
Diskette drive	None			
Media reader	None			
Chipset	Intel G31 Express Chipset; I/O Controller Hub 7 (ICH7) for SATA 3.0Gb/s, ATA-100 EIDE, PCI Express ⁹ x1, PCI 2.3, USB, LPC bus / ITE Tech® IT8718 Super I/O for serial, parallel, keyboard, mouse functions			Security
Front ports	Two USB 2.0, microphone (stereo, 3.5mm), headphone (stereo, 3.5mm)			<ul style="list-style-type: none"> • Security slot (in rear for attachment of optional Kensington® Microsaver® cable) - optional cable also locks the cover by deactivating the cover release buttons • Power-on password • Administrator password • Hard disk password • Boot sequence control • Boot without keyboard, mouse, diskette • Serial port I/O control • Parallel port I/O control • USB port disablement
Rear ports	Four USB 2.0, serial (9-pin), parallel (25-pin), keyboard (PS/2), mouse (PS/2), ethernet (RJ-45), monitor (VGA DB-15)			
Internal connector	Two USB 2.0 planar connectors (one used; one open for media reader)			
Rear audio ports	Line-in (stereo, 3.5mm), line-out (stereo, 3.5mm), microphone (stereo, 3.5mm)			
Audio	High Definition (HD) Audio, Realtek® ALC662 codec			
Speaker	One internal speaker for business audio			
Ethernet	Gigabit ethernet on planar, Marvell® 88E8056, PCIe x1, Wake on LAN®			
Intel AMT	None			
Modem	None			
Security chip	None			
Keyboard	Preferred Pro USB Keyboard (USB connector), 104-key, black, Lenovo logo			
Mouse	Optical Wheel Mouse (USB connector), 400 dpi, black, Lenovo logo			
Power supply	280 watts with variable speed fan, autosensing			
Preloaded operating system ²⁰			Supports ThinkVantage® technologies	
<ul style="list-style-type: none"> - Microsoft® Windows® XP Professional with Vista® COA ◆ Disk-to-Disk Recovery (in hidden protected area) 			RoHS-compliant	
Preloaded applications ⁵			Limited Warranty ¹	
<ul style="list-style-type: none"> • Rescue and Recovery™ • Client Security Solution™ • ThinkVantage Productivity Center • ThinkVantage System Update • System Migration Assistant • Norton Internet Security™ (90 days of virus definitions) • Diskeeper® Home • PC-Doctor™ (diagnostics) • Adobe® Reader • Windows Live™ Toolbar • Windows Live Search • Picasa from Google • Microsoft Office 2007 Trial (60-day) • Multimedia Center for Think Offerings (DVD, DVD±RW) • Sonic RecordNow and Drive Letter Access (DVD±RW) • Corel® WinDVD® (DVD, DVD±RW) • Corel WinDVD Creator (DVD±RW) 			<ul style="list-style-type: none"> ↔ 1-year parts and labor ↔ International Warranty Service⁹ ↔ Customer Replaceable Unit (CRU) parts only (with limited onsite service for selected parts³, 8 am - 5 pm, Mon - Fri coverage excluding holidays, next business day response time) ↔ Onsite service upgrade options (in eligible locations):⁷ <ul style="list-style-type: none"> • 1-year LOR 9x5, 4 hour response (ThinkPlus™ part number 41C9189) • 2-year LOR 9x5, Next Business Day (ThinkPlus part number 41C9187) • 2-year LOR 9x5, 4 hour response (ThinkPlus part number 41C9190) • 3-year LOR 9x5, Next Business Day (ThinkPlus part number 41C9188) • 3-year LOR 9x5, 4 hour response (ThinkPlus part number 41C9191) ↔ ThinkPlus services at lenovo.com/thinkplus/warranty ↔ Post warranty maintenance services available ↔ 24 hour x 7 day¹⁴ toll-free support during the warranty period¹ via 800-426-7378 	
Accessories				
1GB PC2-5300 DDR2 UDIMM (TopSeller)			43R2001	
2GB PC2-5300 DDR2 UDIMM (TopSeller)			43R2002	
250GB SATA 3.0Gb/s Disk (7200 rpm)			41N3015	
500GB SATA 3.0Gb/s Disk (7200 rpm)			43R1990	
USB Portable Diskette Drive			05K9276	
USB 2.0 Lenovo Multimedia Headset			40Y8518	
USB 2.0 Lenovo Webcam			40Y8519	
USB 2.0 Essential Memory Key 32GB			45K1258	
USB 2.0 Security Memory Key 4GB			41U5120	
USB 2.0 Ultra Secure Memory Key 2GB			45J5916	
USB 2.0 Ultra Secure Memory Key 4GB			45J5917	
USB 2.0 Ultra Secure Memory Key 8GB			45J5918	
USB 2.0 Portable 160GB Hard Disk			43R1784	
USB 2.0 Portable Secure 320GB Hard Disk			43R2019	
USB 2.0 Super Multi-Burner Drive			41N5565	
ThinkVision® L1700p 17" Monitor			9417HE2	
ThinkVision L1940p Wide 19" Monitor			4424HB6	
ThinkVision L2240p Wide 22" Monitor			4422HB6	
ThinkVision L2440p Wide 24" Monitor			4420HB2	
Wireless Kbd & Opt Wheel Mouse (via USB)			73P4067	
Laser Tilt Wheel Mouse (USB, PS/2)			41U3074	
Kensington Cable Lock from Lenovo			73P2582	
ADD2 DVI-I PCIe Connection Adapter			73P2516	
ADD2 DVI-D Monitor Connection (HDCP)			43R1985	
ATI™ Radeon™ HD 2400 Pro 128MB			43R1961	
ATI Radeon HD 2400 XT 256MB			43R1962	
Acc Guide in pdf lenovo.com/accessoriesguide				
Other accessories at lenovo.com/accessories				

See footnotes for important warranty information
US models announced October 21, 2008

ThinkCentre® A57 Small (9704) - TopSeller (Vista®)

Personal Systems Reference (PSREF)

Name	Type-model	Slot x bay	Processor	GHz	L2 cache	Core	Memory ⁶	SATA disk	SATA optical	Graphics	Chassis intr switch	Vista preload	Vista logo	Global Educ	Avail date
ES	A57	9704-BRU	2x3 Pentium E2180	2.00	1MB	Dual	512MB	80GB ²	DVD	GMA		Bus32	Basic	None	Apr 08
ES	A57	9704-BSU	2x3 Pentium E2180	2.00	1MB	Dual	1GB	160GB	Combo	GMA		Bus32	Basic	None	Apr 08
ES	A57	9704-BFU	2x3 Pentium E2180	2.00	1MB	Dual	2GB	160GB	DVD±RW	GMA		Bus32	Prem	None	Apr 08
	A57	9704-AKU	2x3 Core 2 Duo E4600	2.40	2MB	Dual	2GB	160GB	Combo	GMA	Switch	Bus32	Prem	None	Mar 08

- These small and medium business (SMB) models are part of the US TopSeller™ Program
- These models have a 1-year limited warranty¹

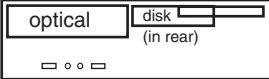
Positioning Processor	Quality, reliability, and security for small/medium businesses Intel® Pentium® Dual-Core Processor E2180 with dual-core, Intel 64 Technology, Execute Disable Bit, EIST, 800MHz system bus, and 1MB shared L2 cache or Intel Core™ 2 Duo Processor E4600 with dual-core, Intel 64 Technology, Execute Disable Bit, EIST, and 800MHz system bus with 2MB shared L2 cache	Small	
Implementation	Processor in FC-LGA6 package in LGA775 socket		
Memory	512MB, 1GB, or 2GB std , 4GB max ⁸ , PC2-5300 667MHz DDR2 , non-parity, dual-channel capable, two 240-pin DIMM sockets; <i>Italics:</i> standard memory in both sockets; no sockets avail; <i>Non-italics:</i> standard memory in one socket; one socket available	Bay ① 5.25", 1.6" high, access, std optical Bay ② 3.5", 1" high, no access, std disk Bay ③ 3.5", .5" high, access, open (reader/diskette) Slot 1: Low Profile, PCI Express x16 (35w max) Slot 2: Low Profile, 32-bit PCI 2.3 <ul style="list-style-type: none"> • Business black color; metal case • 12.5" W X 14.0" D X 3.9" H • 317mm W X 355mm D X 99mm H • 16.1 lb (7.3 kg) in maximum configuration • Bays 1, 2, 3 flip up (latched and pivoting) • Toolless cover flips up and tilts backward on rear hinges • Toolless disk, diskette drive, optical drive removal • Toolless adapter retention • Toolless systemboard retention • Steel chassis supports 100 lb (45kg) monitor on top • System floor stand for vertical orientation 	
Graphics	Intel Graphics Media Accelerator 3100 (GMA 3100) , integrated graphics in G31, uses main memory (up to 256MB), one analog VGA DB-15 connector, supports dual independent display with optional ADD2 adapter		
SATA disk	80GB or 160GB , SATA 3.0Gb/s 7200 rpm, vibration dampening		
SATA controller	Serial ATA, SATA 3.0Gb/s, integrated in ICH7		
SATA DVD	<i>Some:</i> DVD-ROM DL SATA 1.5Gb/s 16X-48X Max ⁴ (41N5618)		
SATA Combo	<i>Some:</i> CD-RW/DVD-ROM Combo SATA 1.5Gb/s Drive		
SATA DVD±RW	<i>Some:</i> Super Multi-Burner DL DVD±RW SATA 1.5Gb/s Drive (41N5620)		
SATA cables	Two SATA cables (each 1-drop to device), two SATA connectors on planar		
eSATA port	None		
EIDE controller	Enhanced IDE, ATA-100, integrated in ICH7, one EIDE connector on planar		
Diskette drive	None		
Media reader	None		
Chipset	Intel G31 Express Chipset ; I/O Controller Hub 7 (ICH7) for SATA 3.0Gb/s, ATA-100 EIDE, PCI Express® x1, PCI 2.3, USB, LPC bus / ITE Tech® IT8718 Super I/O for serial, parallel, keyboard, mouse functions	Security <ul style="list-style-type: none"> • Security slot (in rear for attachment of optional Kensington® Microsaver® cable) - optional cable also locks the cover by deactivating the cover release buttons • Power-on password • Administrator password • Hard disk password • Boot sequence control • Boot without keyboard, mouse, diskette • Serial port I/O control • Parallel port I/O control • USB port disablement • <i>Some:</i> Chassis intrusion switch Supports ThinkVantage® technologies RoHS-compliant Limited Warranty¹ <ul style="list-style-type: none"> ↔ 1-year parts and labor ↔ International Warranty Service⁹ ↔ Customer Replaceable Unit (CRU) parts only (with limited onsite service for selected parts³, 8 am - 5 pm, Mon - Fri coverage excluding holidays, next business day response time) ↔ Onsite service upgrade options (in eligible locations):⁷ <ul style="list-style-type: none"> • 1-year LOR 9x5, 4 hour response (ThinkPlus™ part number 41C9189) • 2-year LOR 9x5, Next Business Day (ThinkPlus part number 41C9187) • 2-year LOR 9x5, 4 hour response (ThinkPlus part number 41C9190) • 3-year LOR 9x5, Next Business Day (ThinkPlus part number 41C9188) • 3-year LOR 9x5, 4 hour response (ThinkPlus part number 41C9191) ↔ ThinkPlus services at lenovo.com/thinkplus/warranty ↔ Post warranty maintenance services available ↔ 24 hour x 7 day¹⁴ toll-free support during the warranty period¹ via 800-426-7378 	
Front ports	Two USB 2.0, microphone (stereo, 3.5mm), headphone (stereo, 3.5mm)		
Rear ports	Four USB 2.0, serial (9-pin), parallel (25-pin), keyboard (PS/2), mouse (PS/2), ethernet (RJ-45), monitor (VGA DB-15)		
Internal connector	Two USB 2.0 planar connectors (one used; one open for media reader)		
Rear audio ports	Line-in (stereo, 3.5mm), line-out (stereo, 3.5mm), microphone (stereo, 3.5mm)		
Audio	High Definition (HD) Audio, Realtek® ALC662 codec		
Speaker	One internal speaker for business audio		
Ethernet	Gigabit ethernet on planar, Marvel® 88E8056, PCIe x1, Wake on LAN®		
Intel AMT	None		
Modem	None		
Security chip	None		
Keyboard	Preferred Pro USB Keyboard (USB connector), 104-key, black, Lenovo logo		
Mouse	Optical Wheel Mouse (USB connector), 400 dpi, black, Lenovo logo		
Power supply	280 watts with variable speed fan, autosenesing		
Preloaded operating system²⁰	Accessories		
- Microsoft® Windows® Vista Business Edition (32-bit)	1GB PC2-5300 DDR2 UDIMM (TopSeller) 43R2001		
	2GB PC2-5300 DDR2 UDIMM (TopSeller) 43R2002		
	250GB SATA 3.0Gb/s Disk (7200 rpm) 41N3015		
	500GB SATA 3.0Gb/s Disk (7200 rpm) 43R1990		
	USB Portable Diskette Drive 05K9276		
	USB 2.0 Lenovo Multimedia Headset 40Y8518		
	USB 2.0 Lenovo Webcam 40Y8519		
	USB 2.0 Essential Memory Key 32GB 45K1258		
	USB 2.0 Ultra Secure Memory Key 8GB 45J5918		
	USB 2.0 Portable 160GB Hard Disk 43R1784		
	USB 2.0 Portable Secure 320GB Hard Disk 43R2019		
	ThinkVision® L1700p 17" Monitor 9417HE2		
	ThinkVision L1940p Wide 19" Monitor 4424HB6		
	ThinkVision L2240p Wide 22" Monitor 4422HB6		
	ThinkVision L2440p Wide 24" Monitor 4420HB2		
	Wireless Kbd & Opt Wheel Mouse (via USB) 73P4067		
	Laser Tilt Wheel Mouse (USB, PS/2) 41U3074		
	Kensington Cable Lock from Lenovo 73P2582		
	ADD2 DVI-I PCIe Connection Adapter 73P2516		
	ADD2 DVI-D Monitor Connection (HDCP) 43R1985		
	ATI™ Radeon™ HD 2400 Pro 128MB 43R1961		
	ATI Radeon HD 2400 XT 256MB 43R1962		
	Acc Guide in pdf lenovo.com/accessoriesguide		
	Other accessories at lenovo.com/accessories		

See footnotes for important warranty information

ES US models announced April 8, 2008; previous model on February 26, 2008

© Lenovo (TUNS1-2) April 2008

Name	Type-model	Slot x bay	Processor	GHz	L2 cache	Core	Memory ⁸	SATA disk	2nd Disk Bay	SATA optical	Graphics	Preload warranty ¹	Limited warranty ¹	Global Educ	Avail date
A57	9702-B3U	4x4	Celeron 430	1.80	512KB	Single	512MB	80GB ²	None	DVD	GMA	XP Pro	1-yr	None	Mar 08
A57	9702-B7U	4x4	Pentium E2160	1.80	1MB	Dual	1GB	160GB	None	DVD±RW	GMA	XP Pro	1-yr	None	Mar 08
A57	9702-B5U	4x4	Pentium E2180	2.00	1MB	Dual	512MB	80GB	None	DVD	GMA	XP Pro	1-yr	None	Mar 08
A57	9702-B6U	4x4	Pentium E2180	2.00	1MB	Dual	512MB	160GB	None	Combo	GMA	XP Pro	1-yr	None	Mar 08
A57	9702-D9U	4x4	Pentium E2180	2.00	1MB	Dual	1GB	160GB	None	DVD±RW	GMA	XP Pro	1-yr	None	Apr 08
A57	9702-A4U	4x4	Pentium E2200	2.20	1MB	Dual	1GB	160GB	None	Combo	GMA	XP Pro	1-yr	None	Mar 08
A57	9702-A5U	4x4	Pentium E2200	2.20	1MB	Dual	2GB	160GB	None	DVD±RW	GMA	XP Pro	1-yr	None	Mar 08

• **These small and medium business (SMB) models are part of the US TopSeller™ Program**

Positioning Processor	<p><i>Quality, reliability, and security for small/medium businesses</i></p> <p>Intel® Celeron® Processor 430 with single-core, Intel 64 Tech, Execute Disable Bit, 800MHz system bus, and 512KB L2 cache or Intel Pentium® Dual-Core Processor E2160, E2180, or E2200 with dual-core, Intel 64 Technology, Execute Disable Bit, EIST, and 800MHz system bus with 1MB shared L2 cache Processor in FC-LGA6 package in LGA775 socket</p>		<p>Tower</p> <ul style="list-style-type: none"> • Business black color; metal case • 6.9" W X 17.3" D X 15.8" H • 175mm W X 440mm D X 402mm H • 24.2 lb (11.0 kg) in max configuration • Handle on top front • Toolless cover removal • Toolless disk, diskette drive, optical drive removal • Toolless adapter retention 	
Implementation			<p>Bay ① 5.25", 1.6" high, access, std optical</p> <p>Bay ② 5.25", 1.6" high, access, open</p> <p>Bay ③ 3.5", 1" high, access, open (reader/diskette)</p> <p>Bay ④ 3.5", 1" high, no access, std disk</p>	
Memory	<p>512MB, 1GB, or 2GB std, 4GB max⁸, PC2-5300 667MHz DDR2, non-parity, dual-channel capable, two 240-pin DIMM sockets; <i>Italics:</i> standard memory in both sockets; no sockets avail; <i>Non-italics:</i> standard memory in one socket; one socket available</p>		<p>Slot 1: half-length, full-height, PCI Express x16 (75w max)</p> <p>Slot 2: half-length, full-height, PCI Express x1</p> <p>Slot 3: half-length, full-height, 32-bit PCI 2.3</p> <p>Slot 4: half-length, full-height, 32-bit PCI 2.3</p>	
Graphics	<p>Intel Graphics Media Accelerator 3100 (GMA 3100), integrated graphics in G31, uses main memory (up to 256MB), one analog VGA DB-15 connector, supports dual independent display with optional ADD2 adapter</p>			
SATA disk	<p>80GB or 160GB, SATA 3.0Gb/s 7200 rpm, vibration dampening Serial ATA, SATA 3.0Gb/s, integrated in ICH7</p>			
SATA controller	<p>Some: DVD-ROM/DL SATA 1.5Gb/s 16X-48X Max⁴ (41N5618)</p>			
SATA DVD	<p>Some: CD-RW/DVD-ROM Combo SATA 1.5Gb/s Drive</p>			
SATA Combo	<p>Some: Super Multi-Burner DL DVD±RW SATA 1.5Gb/s Drive (41N5620)</p>			
SATA DVD±RW	<p>Two SATA cables (each 1-drop to device), four SATA connectors on planar</p>			
SATA cables	<p>None</p>			
eSATA port	<p>Enhanced IDE, ATA-100, integrated in ICH7, one EIDE connector on planar</p>			
EIDE controller	<p>None</p>			
Diskette drive	<p>None</p>			
Media reader	<p>None</p>			
Chipset	<p>Intel G31 Express Chipset; I/O Controller Hub 7 (ICH7) for SATA 3.0Gb/s, ATA-100 EIDE, PCI Express⁹ x1, PCI 2.3, USB, LPC bus / ITE Tech[®] IT8718 Super I/O for serial, parallel, keyboard, mouse functions</p>			
Front ports	<p>Two USB 2.0, microphone (stereo, 3.5mm), headphone (stereo, 3.5mm)</p>			
Rear ports	<p>Four USB 2.0, serial (9-pin), parallel (25-pin), keyboard (PS/2), mouse (PS/2), ethernet (RJ-45), monitor (VGA DB-15)</p>			
Internal connector	<p>Two USB 2.0 planar connectors (one used; one open for media reader)</p>			
Rear audio ports	<p>Line-in (stereo, 3.5mm), line-out (stereo, 3.5mm), microphone (stereo, 3.5mm)</p>			
Audio	<p>High Definition (HD) Audio, Realtek[®] ALC662 codec</p>			
Speaker	<p>One internal speaker for business audio</p>			
Ethernet	<p>Gigabit ethernet on planar, Marvell[®] 88E8056, PCIe x1, Wake on LAN[®]</p>			
Intel AMT	<p>None</p>			
Modem	<p>None</p>			
Security chip	<p>None</p>			
Keyboard	<p>Preferred Pro USB Keyboard (USB connector), 104-key, black, Lenovo logo</p>			
Mouse	<p>Optical Wheel Mouse (USB connector), 400 dpi, black, Lenovo logo</p>			
Power supply	<p>280 watts with variable speed fan, manual switch</p>			
Preloaded operating system²⁰	<p>- Microsoft[®] Windows[®] XP Professional with Vista[®] COA</p> <p>◇ Disk-to-Disk Recovery (in hidden protected area)</p>			
Preloaded applications⁵	<ul style="list-style-type: none"> • Rescue and Recovery™ • Client Security Solution™ • ThinkVantage Productivity Center • ThinkVantage System Update • System Migration Assistant • Norton Internet Security™ • Diskeeper[®] Home • PC-Doctor™ (diagnostics) • Adobe[®] Reader • Windows Live™ Toolbar • Windows Live Search • Picasa from Google • Microsoft Office 2007 Trial (60-day) • Multimedia Center for Think Offerings (combo, DVD, DVD±RW) • Sonic RecordNow and Drive Letter Access (combo, DVD±RW) • Corel[®] WinDVD[®] (combo, DVD, DVD±RW) • Corel WinDVD Creator (DVD±RW) 			
Accessories	<p>1GB PC2-5300 DDR2 UDIMM (TopSeller) 43R2001</p> <p>2GB PC2-5300 DDR2 UDIMM (TopSeller) 43R2002</p> <p>250GB SATA 3.0Gb/s Disk (7200 rpm) 41N3015</p> <p>500GB SATA 3.0Gb/s Disk (7200 rpm) 43R1990</p> <p>USB 2.0 Lenovo Multimedia Headset 40Y8518</p> <p>USB 2.0 Lenovo Webcam 40Y8519</p> <p>USB 2.0 Essential Memory Key 32GB 45K1258</p> <p>USB 2.0 Ultra Secure Memory Key 8GB 45J5918</p> <p>USB 2.0 Portable 160GB Hard Disk 43R1784</p> <p>USB 2.0 Portable Secure 320GB Hard Disk 43R2019</p> <p>ThinkVision[™] L1700p 17" Monitor 9417HE2</p> <p>ThinkVision L1940p Wide 19" Monitor 4424HB6</p> <p>ThinkVision L2240p Wide 22" Monitor 4422HB6</p> <p>ThinkVision L2440p Wide 24" Monitor 4420HB2</p> <p>Wireless Kbd & Opt Wheel Mouse (via USB) 73P4067</p> <p>Laser Tilt Wheel Mouse (USB, PS/2) 41U3074</p> <p>Kensington Cable Lock from Lenovo 73P2582</p> <p>ADD2 DVI-I PCIe Connection Adapter 73P2516</p> <p>ADD2 DVI-D Monitor Connection (HDCP) 43R1985</p> <p>ATI™ Radeon™ HD 2400 Pro 128MB 43R1961</p> <p>ATI Radeon HD 2400 XT 256MB 43R1962</p> <p>ATI Radeon HD 2600 XT 512MB 43R1963</p> <p>Acc Guide in pdf lenovo.com/accessoriesguide</p> <p>Other accessories at lenovo.com/accessories</p>			
			<p>Security</p> <ul style="list-style-type: none"> • One lock to secure both cover and entire system to fixed object: <ul style="list-style-type: none"> - Padlock loop (in rear for opt padlock) - Security slot (in rear for optional Kensington[®] Microsaver[®] cable) • Power-on password • Administrator password • Hard disk password • Boot sequence control • Boot without keyboard, mouse, diskette • Serial port I/O control • Parallel port I/O control • USB port disablement 	
			<p>Supports ThinkVantage[®] technologies</p>	
			<p>RoHS-compliant</p>	
			<p>Limited Warranty¹</p> <ul style="list-style-type: none"> ⇨ 1-year parts and labor ⇨ International Warranty Service⁹ ⇨ Customer Replaceable Unit (CRU) parts only (with limited onsite service for selected parts³, 8 am - 5 pm, Mon - Fri coverage excluding holidays, next business day response time) ⇨ Onsite service upgrade options (in eligible locations):⁷ <ul style="list-style-type: none"> • 1-year LOR 9x5, 4 hour response (ThinkPlus™ part number 41C9189) • 2-year LOR 9x5, Next Business Day (ThinkPlus part number 41C9187) • 2-year LOR 9x5, 4 hour response (ThinkPlus part number 41C9190) • 3-year LOR 9x5, Next Business Day (ThinkPlus part number 41C9188) • 3-year LOR 9x5, 4 hour response (ThinkPlus part number 41C9191) ⇨ ThinkPlus services at lenovo.com/thinkplus/warranty ⇨ Post warranty maintenance services available ⇨ 24 hour x 7 day¹⁴ toll-free support during the warranty period¹ via 800-426-7378 	

See footnotes for important warranty information

¹⁸ US model announced April 8, 2008; previous models on February 26, 2008

Name	Type-model	Slot x bay	Processor	GHz	Cores	Memory ⁸	SATA disk	2nd Disk Bay	SATA optical	Graphics	Preload	Vista logo	Limited warranty ¹	Global Educ	Avail date
A57	9702-FDU	4x4	Pentium E2200	2.20	2	512MB	160GB ²	None	DVD	GMA	XP Pro	Basic	1-yr	None	Nov 08
A57	9702-F9U	4x4	Pentium E2200	2.20	2	1GB	160GB	None	DVD±RW	GMA	XP Pro	Premium	1-yr	None	Nov 08

• These small and medium business (SMB) models are part of the US TopSeller™ Program

Positioning Processor	<p><i>Quality, reliability, and security for small/medium businesses</i> Intel® Pentium® Dual-Core Processor E2200 with dual-core, 800MHz system bus, and 1MB L2 cache</p>										<p>Tower</p> <ul style="list-style-type: none"> • Business black color; metal case • 6.9" W X 17.3" D X 15.8" H • 175mm W X 440mm D X 402mm H • 24.2 lb (11.0 kg) in max configuration • Handle on top front • Toolless cover removal • Toolless disk, diskette drive, optical drive removal • Toolless adapter retention
Implementation	Processor in FC-LGA6 package in LGA775 socket										
Memory	<p>512MB or 1GB std, 4GB max³, PC2-5300 667MHz DDR2, non-parity, dual-channel capable, two 240-pin DIMM sockets; <i>Non-italics</i>: standard memory in one socket; one socket available</p>										
Graphics	<p>Intel Graphics Media Accelerator 3100 (GMA 3100), integrated graphics in G31, uses main memory (up to 256MB), one analog VGA DB-15 connector, supports dual independent display with optional ADD2 adapter</p>										
SATA disk	<p>160GB, SATA 3.0Gb/s 7200 rpm, vibration dampening mounts</p>										<p>Bay ① 5.25", 1.6" high, access, std optical Bay ② 5.25", 1.6" high, access, open Bay ③ 3.5", 1" high, access, open (reader/diskette) Bay ④ 3.5", 1" high, no access, std disk</p> <p>Slot 1: half-length, full-height, PCI Express x16 (75w max) Slot 2: half-length, full-height, PCI Express x1 Slot 3: half-length, full-height, 32-bit PCI 2.3 Slot 4: half-length, full-height, 32-bit PCI 2.3</p>
SATA controller	Serial ATA, SATA 3.0Gb/s, integrated in ICH7										
SATA DVD	<p><i>Some</i>: DVD-ROM DL SATA 1.5Gb/s 16X-48X Max⁴ (41N5618)</p>										
SATA DVD±RW	<p><i>Some</i>: Super Multi-Burner DL DVD±RW SATA Drive (41N5620)</p>										
SATA cables	Two SATA cables (each 1-drop to device), four SATA connectors										
eSATA port	None										
EIDE controller	Enhanced IDE, ATA-100, integrated in ICH7, one EIDE connector										
Diskette drive	None										
Media reader	None										
Chipset	<p>Intel G31 Express Chipset; I/O Controller Hub 7 (ICH7) for SATA 3.0Gb/s, ATA-100 EIDE, PCI Express[®] x1, PCI 2.3, USB, LPC bus / ITE Tech[®] IT8718 Super I/O for serial, parallel, keyboard, mouse functions</p>										
Front ports	Two USB 2.0, microphone (stereo, 3.5mm), headphone (stereo, 3.5mm)										
Rear ports	Four USB 2.0, serial (9-pin), parallel (25-pin), keyboard (PS/2), mouse (PS/2), ethernet (RJ-45), monitor (VGA DB-15)										
Internal connector	Two USB 2.0 planar connectors (one used; one open for media reader)										
Rear audio ports	Line-in (stereo, 3.5mm), line-out (stereo, 3.5mm), microphone (stereo, 3.5mm)										
Audio	High Definition (HD) Audio, Realtek [®] ALC662 codec										
Speaker	One internal speaker for business audio										
Ethernet	Gigabit ethernet on planar, Marvell [®] 88E8056, PCIe x1, Wake on LAN [®]										
Intel AMT	None										
Modem	None										
Security chip	None										
Keyboard	Preferred Pro USB Keyboard (USB connector), 104-key, black, Lenovo logo										
Mouse	Optical Wheel Mouse (USB connector), 400 dpi, black, Lenovo logo										
Power supply	280 watts with variable speed fan, manual switch										
Preloaded operating system²⁰	<p>- Microsoft[®] Windows[®] XP Professional with Vista[®] COA ◇ Disk-to-Disk Recovery (in hidden protected area)</p>										
Preloaded applications⁵	<ul style="list-style-type: none"> • Rescue and Recovery™ • Client Security Solution™ • ThinkVantage Productivity Center • ThinkVantage System Update • System Migration Assistant • Norton Internet Security™ • Diskeeper[®] Home • PC-Doctor™ (diagnostics) • Adobe[®] Reader • Windows Live™ Toolbar • Windows Live Search • Picasa from Google • Microsoft Office 2007 Trial (60-day) • Multimedia Center for Think Offerings (DVD, DVD±RW) • Sonic RecordNow and Drive Letter Access (DVD±RW) • Corel[®] WinDVD[®] (DVD, DVD±RW) • Corel WinDVD Creator (DVD±RW) 										
Accessories	<ul style="list-style-type: none"> 1GB PC2-5300 DDR2 UDIMM (TopSeller) 43R2001 2GB PC2-5300 DDR2 UDIMM (TopSeller) 43R2002 250GB SATA 3.0Gb/s Disk (7200 rpm) 41N3015 500GB SATA 3.0Gb/s Disk (7200 rpm) 43R1990 USB 2.0 Lenovo Multimedia Headset 40Y8518 USB 2.0 Lenovo Webcam 40Y8519 USB 2.0 Essential Memory Key 32GB 45K1258 USB 2.0 Ultra Secure Memory Key 4GB 45J5917 USB 2.0 Ultra Secure Memory Key 8GB 45J5918 USB 2.0 Portable 160GB Hard Disk 43R1784 USB 2.0 Portable Secure 320GB Hard Disk 43R2019 ThinkVision[®] L1700p 17" Monitor 9417HE2 ThinkVision L1940p Wide 19" Monitor 4424HB6 ThinkVision L2240p Wide 22" Monitor 4422HB6 ThinkVision L2440p Wide 24" Monitor 4420HB2 Wireless Kbd & Opt Wheel Mouse (via USB) 73P4067 Laser Tilt Wheel Mouse (USB, PS/2) 41U3074 Kensington Cable Lock from Lenovo 73P2582 ADD2 DVI-I PCIe Connection Adapter 73P2516 ADD2 DVI-D Monitor Connection (HDCP) 43R1985 ATI™ Radeon™ HD 2400 Pro 128MB 43R1961 ATI Radeon HD 2400 XT 256MB 43R1962 ATI Radeon HD 2600 XT 512MB 43R1963 Acc Guide in pdf lenovo.com/accessoriesguide Other accessories at lenovo.com/accessories 										
<p>Security</p> <ul style="list-style-type: none"> • One lock to secure both cover and entire system to fixed object: <ul style="list-style-type: none"> - Padlock loop (in rear for opt padlock) - Security slot (in rear for optional Kensington[®] Microsaver[®] cable) • Power-on password • Administrator password • Hard disk password • Boot sequence control • Boot without keyboard, mouse, diskette • Serial port I/O control • Parallel port I/O control • USB port disablement 											
Supports ThinkVantage [®] technologies											
RoHS-compliant											
<p>Limited Warranty¹</p> <ul style="list-style-type: none"> ↔ 1-year parts and labor ↔ International Warranty Service⁹ ↔ Customer Replaceable Unit (CRU) parts only (with limited onsite service for selected parts³, 8 am - 5 pm, Mon - Fri coverage excluding holidays, next business day response time) ↔ Onsite service upgrade options (in eligible locations):⁷ <ul style="list-style-type: none"> • 1-year LOR 9x5, 4 hour response (ThinkPlus™ part number 41C9189) • 2-year LOR 9x5, Next Business Day (ThinkPlus part number 41C9187) • 2-year LOR 9x5, 4 hour response (ThinkPlus part number 41C9190) • 3-year LOR 9x5, Next Business Day (ThinkPlus part number 41C9188) • 3-year LOR 9x5, 4 hour response (ThinkPlus part number 41C9191) ↔ ThinkPlus services at lenovo.com/thinkplus/warranty ↔ Post warranty maintenance services available ↔ 24 hour x 7 day¹⁴ toll-free support during the warranty period¹ via 800-426-7378 											

See footnotes for important warranty information
 US models announced October 21, 2008

ThinkCentre® A57 Tower (9702) - TopSeller (Vista®)

Personal Systems Reference (PSREF)

Name	Type-model	Slot x bay	Processor	GHz	L2 cache	Core	Memory ^o	SATA disk	2nd Disk Bay	SATA optical	Graphics	Chassis intr switch	Vista preload	Vista logo	Global Educ	Avail date
A57	9702-B4U	4x4	Celeron 430	1.80	512KB	Single	512MB	80GB ²	No	DVD	GMA		Home Basic	Basic	No	Mar 08
A57	9702-DAU	4x4	Pentium E2180	2.00	1MB	Dual	512MB	80GB	No	DVD	GMA		Business32	Basic	No	Apr 08
A57	9702-D3U	4x4	Pentium E2180	2.00	1MB	Dual	1GB	160GB	No	Combo	GMA		Business32	Basic	No	May 08
A57	9702-D1U	4x4	Pentium E2180	2.00	1MB	Dual	2GB	160GB	No	DVD±RW	GMA		Business32	Prem	No	Apr 08
A57	9702-AMU	4x4	Core 2 Duo E4600	2.40	2MB	Dual	2GB	160GB	No	Combo	GMA	Switch	Business32	Prem	No	Mar 08

- These small and medium business (SMB) models are part of the US TopSeller™ Program
- These models have a 1-year limited warranty¹

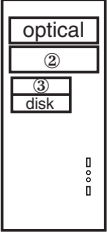
Positioning Processor	<p><i>Quality, reliability, and security for small/medium businesses</i></p> <p>Intel® Celeron® Processor 430 with single-core, Intel 64 Tech, Execute Disable Bit, 800MHz system bus, and 512KB L2 cache or Intel Pentium® Dual-Core Processor E2180 with dual-core, Intel 64 Technology, Execute Disable Bit, EIST, 800MHz system bus, and 1MB shared L2 cache or Intel Core™ 2 Duo Processor E4600 with dual-core, Intel 64 Technology, Execute Disable Bit, EIST, and 800MHz system bus with 2MB shared L2 cache</p> <p>Processor in FC-LGA6 package in LGA775 socket</p>										<p>Tower</p> <ul style="list-style-type: none"> • Business black color; metal case • 6.9" W X 17.3" D X 15.8" H • 175mm W X 440mm D X 402mm H • 24.2 lb (11.0 kg) in max configuration • Handle on top front • Toolless cover removal • Toolless disk, diskette drive, optical drive removal • Toolless adapter retention 		
Implementation											<p>Bay ① 5.25", 1.6" high, access, std optical</p> <p>Bay ② 5.25", 1.6" high, access, open</p> <p>Bay ③ 3.5", 1" high, access, open (reader/diskette)</p> <p>Bay ④ 3.5", 1" high, no access, std disk</p>		
Memory	<p>512MB, 1GB, or 2GB std, 4GB max³, PC2-5300 667MHz DDR2, non-parity, dual-channel capable, two 240-pin DIMM sockets;</p> <p><i>Italics:</i> standard memory in both sockets; no sockets avail;</p> <p><i>Non-italics:</i> standard memory in one socket; one socket available</p>										<p>Slot 1: half-length, full-height, PCI Express x16 (75w max)</p> <p>Slot 2: half-length, full-height, PCI Express x1</p> <p>Slot 3: half-length, full-height, 32-bit PCI 2.3</p> <p>Slot 4: half-length, full-height, 32-bit PCI 2.3</p>		
Graphics	<p>Intel Graphics Media Accelerator 3100 (GMA 3100), integrated graphics in G31, uses main memory (up to 256MB), one analog VGA DB-15 connector, supports dual independent display with optional ADD2 adapter</p>										<p>Security</p> <ul style="list-style-type: none"> • One lock to secure both cover and entire system to fixed object: <ul style="list-style-type: none"> - Padlock loop (in rear for opt padlock) - Security slot (in rear for optional Kensington® Microsaver® cable) • Power-on password • Administrator password • Hard disk password • Boot sequence control • Boot without keyboard, mouse, diskette • Serial port I/O control • Parallel port I/O control • USB port disablement • <i>Some:</i> Chassis intrusion switch 		
SATA disk	<p>80GB or 160GB, SATA 3.0Gb/s 7200 rpm, vibration dampening</p>										<p>Supports ThinkVantage® technologies</p>		
SATA controller	<p>Serial ATA, SATA 3.0Gb/s, integrated in ICH7</p>										<p>RoHS-compliant</p>		
SATA DVD	<p><i>Some:</i> DVD-ROM DL SATA 1.5Gb/s 16-48X Max⁴ Drive (41N5618)</p>										<p>Limited Warranty¹</p> <ul style="list-style-type: none"> ↪ 1-year parts and labor ↪ International Warranty Service⁹ ↪ Customer Replaceable Unit (CRU) parts only (with limited onsite service for selected parts³, 8 am - 5 pm, Mon - Fri coverage excluding holidays, next business day response time) ↪ Onsite service upgrade options (in eligible locations):⁷ <ul style="list-style-type: none"> • 1-year LOR 9x5, 4 hour response (ThinkPlus™ part number 41C9189) • 2-year LOR 9x5, Next Business Day (ThinkPlus part number 41C9187) • 2-year LOR 9x5, 4 hour response (ThinkPlus part number 41C9190) • 3-year LOR 9x5, Next Business Day (ThinkPlus part number 41C9188) • 3-year LOR 9x5, 4 hour response (ThinkPlus part number 41C9191) ↪ ThinkPlus services at lenovo.com/thinkplus/warranty ↪ Post warranty maintenance services available ↪ 24 hour x 7 day¹⁴ toll-free support during the warranty period¹ via 800-426-7378 		
SATA Combo	<p><i>Some:</i> CD-RW/DVD-ROM Combo SATA 1.5Gb/s Drive</p>												
SATA DVD±RW	<p><i>Some:</i> Super Multi-Burner DL DVD±RW SATA 1.5Gb/s Drive (41N5620)</p>												
SATA cables	<p>Two SATA cables (each 1-drop to device), four SATA connectors on planar</p>												
eSATA port	<p>None</p>												
EIDE controller	<p>Enhanced IDE, ATA-100, integrated in ICH7, one EIDE connector on planar</p>												
Diskette drive	<p>None</p>												
Media reader	<p>None</p>												
Chipset	<p>Intel G31 Express Chipset; I/O Controller Hub 7 (ICH7) for SATA 3.0Gb/s, ATA-100 EIDE, PCI Express[®] x1, PCI 2.3, USB, LPC bus / ITE Tech[®] IT8718 Super I/O for serial, parallel, keyboard, mouse functions</p>												
Front ports	<p>Two USB 2.0, microphone (stereo, 3.5mm), headphone (stereo, 3.5mm)</p>												
Rear ports	<p>Four USB 2.0, serial (9-pin), parallel (25-pin), keyboard (PS/2), mouse (PS/2), ethernet (RJ-45), monitor (VGA DB-15)</p>												
Internal connector	<p>Two USB 2.0 planar connectors (one used; one open for media reader)</p>												
Rear audio ports	<p>Line-in (stereo, 3.5mm), line-out (stereo, 3.5mm), microphone (stereo, 3.5mm)</p>												
Audio	<p>High Definition (HD) Audio, Realtek[®] ALC662 codec</p>												
Speaker	<p>One internal speaker for business audio</p>												
Ethernet	<p>Gigabit ethernet on planar, Marvell[®] 88E8056, PCIe x1, Wake on LAN[®]</p>												
Intel AMT	<p>None</p>												
Modem	<p>None</p>												
Security chip	<p>None</p>												
Keyboard	<p>Preferred Pro USB Keyboard (USB connector), 104-key, black, Lenovo logo</p>												
Mouse	<p>Optical Wheel Mouse (USB connector), 400 dpi, black, Lenovo logo</p>												
Power supply	<p>280 watts with variable speed fan, manual switch</p>												
Preloaded operating system^{2o}	<p>Accessories</p>												
- <i>Some:</i> Microsoft® Windows® Vista Home Basic Edition (32-bit)	<p>1GB PC2-5300 DDR2 UDIMM (TopSeller) 43R2001</p>												
- <i>Some:</i> Microsoft Windows Vista Business Edition (32-bit)	<p>2GB PC2-5300 DDR2 UDIMM (TopSeller) 43R2002</p>												
	<p>250GB SATA 3.0Gb/s Disk (7200 rpm) 41N3015</p>												
	<p>500GB SATA 3.0Gb/s Disk (7200 rpm) 43R1990</p>												
	<p>USB 2.0 Lenovo Multimedia Headset 40Y8518</p>												
	<p>USB 2.0 Lenovo Webcam 40Y8519</p>												
	<p>USB 2.0 Essential Memory Key 32GB 45K1258</p>												
	<p>USB 2.0 Ultra Secure Memory Key 8GB 45J5918</p>												
	<p>USB 2.0 Portable 160GB Hard Disk 43R1784</p>												
	<p>USB 2.0 Portable Secure 320GB Hard Disk 43R2019</p>												
	<p>ThinkVision® L1700p 17" Monitor 9417HE2</p>												
	<p>ThinkVision L1940p Wide 19" Monitor 4424HB6</p>												
	<p>ThinkVision L2240p Wide 22" Monitor 4422HB6</p>												
	<p>ThinkVision L2440p Wide 24" Monitor 4420HB2</p>												
	<p>Wireless Kbd & Opt Wheel Mouse (via USB) 73P4067</p>												
	<p>Kensington Cable Lock from Lenovo 73P2582</p>												
	<p>ADD2 DVI-I PCIe Connection Adapter 73P2516</p>												
	<p>ADD2 DVI-D Monitor Connection (HDCP) 43R1985</p>												
	<p>ATI™ Radeon™ HD 2400 Pro 128MB 43R1961</p>												
	<p>ATI Radeon HD 2400 XT 256MB 43R1962</p>												
	<p>ATI Radeon HD 2600 XT 512MB 43R1963</p>												
	<p>Acc Guide in pdf lenovo.com/accessoriesguide</p>												
	<p>Other accessories at lenovo.com/accessories</p>												
Preloaded applications⁵ (all OSes)													
• Rescue and Recovery™													
• Client Security Solution™													
• ThinkVantage Productivity Center													
• ThinkVantage System Update													
• System Migration Assistant													
• Norton Internet Security™ (90 days of virus definitions)													
• Diskeeper® Home													
• PC-Doctor™ (diagnostics)													
• Adobe® Reader													
• Windows Live™ Toolbar													
• Windows Live Search													
• Picasa from Google													
• Microsoft Office 2007 Trial (60-day)													
• EarthLink Trial (Vista Home Basic)													
• Sonic RecordNow and Drive Letter Access (combo, DVD±RW)													
• Corel® WinDVD® (combo, DVD, DVD±RW)													

See footnotes for important warranty information

US model announced April 29, 2008; previous models on February 26 or April 8, 2008

© Lenovo

(TUNS1-4) May 2008

Name	Type-model	Slot x bay	Processor	GHz	L2 cache	Core	Memory ^a	SATA disk	2nd Disk Bay	SATA optical	Graphics	Vista preload	Vista logo	Global Educ	Avail date
A57	9702-H8U	4x4	Celeron E1200	1.60	512KB	Dual	1GB	160GB ^b	No	DVD±RW	GMA	Home Basic	Basic	No	Dec 08
A57	9702-H9U	4x4	Pentium E2160	1.80	1MB	Dual	2GB	160GB	No	DVD±RW	GMA	Home Basic	Basic	No	Dec 08
A57	9702-HBU	4x4	Pentium E2160	1.80	1MB	Dual	2GB	320GB	No	DVD±RW	GMA	Home Premium	Basic	No	Dec 08
A57	9702-HCU	4x4	Pentium E5200	2.50	2MB	Dual	2GB	160GB	No	DVD±RW	GMA	Home Basic	Basic	No	Dec 08

- These small and medium business (SMB) models are part of the US TopSeller™ Program
- These models have a 1-year limited warranty¹

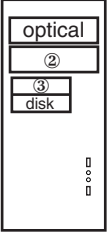
Positioning Processor	<p><i>Quality, reliability, and security for small/medium businesses</i></p> <p>Intel® Celeron® Dual-Core Processor E1200 with dual-core, Intel 64 Technology, Execute Disable Bit, EIST, 800MHz system bus, and 512KB L2 cache or Intel Pentium® Dual-Core Processor E2160 with dual-core, Intel 64 Technology, Execute Disable Bit, EIST, 800MHz system bus, and 1MB L2 cache or Intel Pentium Dual-Core Processor E5200 with dual-core, Intel 64 Technology, Execute Disable Bit, EIST, and 800MHz system bus with 2MB L2 cache</p>		<p>Tower</p> <ul style="list-style-type: none"> • Business black color; metal case • 6.9" W X 17.3" D X 15.8" H • 175mm W X 440mm D X 402mm H • 24.2 lb (11.0 kg) in max configuration • Handle on top front • Toolless cover removal • Toolless disk, diskette drive, optical drive removal • Toolless adapter retention 	
Implementation	Processor in FC-LGA6 package in LGA775 socket			
Memory	<p>1GB or 2GB std, 4GB max^c, PC2-6400 800MHz DDR2, non-parity, dual-channel capable, two 240-pin DIMM sockets; <i>Non-italics</i>: standard memory in one socket; one socket available</p>		<p>Bay ① 5.25", 1.6" high, access, std optical</p> <p>Bay ② 5.25", 1.6" high, access, open</p> <p>Bay ③ 3.5", 1" high, access, open (reader/diskette)</p> <p>Bay ④ 3.5", 1" high, no access, std disk</p>	
Graphics	<p>Intel Graphics Media Accelerator 3100 (GMA 3100), integrated graphics in G31, uses main memory (up to 256MB), one analog VGA DB-15 connector, supports dual independent display with optional ADD2 adapter</p>		<p>Slot 1: half-length, full-height, PCI Express x16 (75w max)</p> <p>Slot 2: half-length, full-height, PCI Express x1</p> <p>Slot 3: half-length, full-height, 32-bit PCI 2.3</p> <p>Slot 4: half-length, full-height, 32-bit PCI 2.3</p>	
SATA disk	<p>160GB or 320GB, SATA 3.0Gb/s 7200 rpm, vibration dampening</p>			
SATA controller	<p>Serial ATA, SATA 3.0Gb/s, integrated in ICH7</p>			
SATA DVD±RW	<p>Super Multi-Burner DL DVD±RW SATA 1.5Gb/s Drive (41N5620)</p>			
SATA cables	<p>Two SATA cables (each 1-drop to device), four SATA connectors on planar</p>			
eSATA port	<p>None</p>			
EIDE controller	<p>Enhanced IDE, ATA-100, integrated in ICH7, one EIDE connector on planar</p>			
Diskette drive	<p>None</p>			
Media reader	<p>None</p>			
Chipset	<p>Intel G31 Express Chipset; I/O Controller Hub 7 (ICH7) for SATA 3.0Gb/s, ATA-100 EIDE, PCI Express® x1, PCI 2.3, USB, LPC bus / ITE Tech® IT8718 Super I/O for serial, parallel, keyboard, mouse functions</p>			
Front ports	<p>Two USB 2.0, microphone (stereo, 3.5mm), headphone (stereo, 3.5mm)</p>			
Rear ports	<p>Four USB 2.0, serial (9-pin), parallel (25-pin), keyboard (PS/2), mouse (PS/2), ethernet (RJ-45), monitor (VGA DB-15)</p>			
Internal connector	<p>Two USB 2.0 planar connectors (one used; one open for media reader)</p>			
Rear audio ports	<p>Line-in (stereo, 3.5mm), line-out (stereo, 3.5mm), microphone (stereo, 3.5mm)</p>			
Audio	<p>High Definition (HD) Audio, Realtek® ALC662 codec</p>			
Speaker	<p>One internal speaker for business audio</p>			
Ethernet	<p>Gigabit ethernet on planar, Marvell® 88E8056, PCIe x1, Wake on LAN®</p>			
Intel AMT	<p>None</p>			
Modem	<p>None</p>			
Security chip	<p>None</p>			
Keyboard	<p>Preferred Pro USB Keyboard (USB connector), 104-key, black, Lenovo logo</p>			
Mouse	<p>Optical Wheel Mouse (USB connector), 400 dpi, black, Lenovo logo</p>			
Power supply	<p>280 watts with variable speed fan, manual switch</p>			
Preloaded operating system²⁰	<p>- <i>Some</i>: Microsoft® Windows® Vista Home Basic Edition (32-bit)</p> <p>- <i>Some</i>: Microsoft Windows Vista Home Premium Edition (32-bit)</p>			
Preloaded applications⁵ (all OSes)	<ul style="list-style-type: none"> • Rescue and Recovery™ • Client Security Solution™ • ThinkVantage Productivity Center • ThinkVantage System Update • System Migration Assistant • Norton Internet Security™ (90 days of virus definitions) • Diskeeper® Home • PC-Doctor™ (diagnostics) • Adobe® Reader • Windows Live™ Toolbar • Windows Live Search • Picasa from Google • Microsoft Office 2007 Trial (60-day) • EarthLink Trial • Sonic RecordNow and Drive Letter Access (DVD±RW) • Corel® WinDVD® (DVD±RW) 			
Accessories	<ul style="list-style-type: none"> 1GB PC2-6400 NP DDR2 UDIMM 41U2977 2GB PC2-6400 NP DDR2 UDIMM 41U2978 250GB SATA 3.0Gb/s Disk (7200 rpm) 41N3015 500GB SATA 3.0Gb/s Disk (7200 rpm) 43R1990 USB 2.0 Lenovo Multimedia Headset 40Y8518 USB 2.0 Lenovo Webcam 40Y8519 USB 2.0 Essential Memory Key 32GB 45K1258 USB 2.0 Ultra Secure Memory Key 4GB 45J5917 USB 2.0 Ultra Secure Memory Key 8GB 45J5918 USB 2.0 Portable 160GB Hard Disk 43R1784 USB 2.0 Portable Secure 320GB Hard Disk 43R2019 ThinkVision® L1700p 17" Monitor 9417HE2 ThinkVision L1940p Wide 19" Monitor 4424HB6 ThinkVision L2240p Wide 22" Monitor 4422HB6 ThinkVision L2440p Wide 24" Monitor 4420HB2 Wireless Kbd & Opt Wheel Mouse (via USB) 73P4067 Laser Tilt Wheel Mouse (USB, PS/2) 41U3074 Kensington Cable Lock from Lenovo 73P2582 ADD2 DVI-I PCIe Connection Adapter 73P2516 ADD2 DVI-D Monitor Connection (HDCP) 43R1985 ATI™ Radeon™ HD 2400 Pro 128MB 43R1961 ATI Radeon HD 2400 XT 256MB 43R1962 ATI Radeon HD 2600 XT 512MB 43R1963 Acc Guide in pdf lenovo.com/accessoriesguide Other accessories at lenovo.com/accessories 			
			<p>Security</p> <ul style="list-style-type: none"> • One lock to secure both cover and entire system to fixed object: <ul style="list-style-type: none"> - Padlock loop (in rear for opt padlock) - Security slot (in rear for optional Kensington® Microsaver® cable) • Power-on password • Administrator password • Hard disk password • Boot sequence control • Boot without keyboard, mouse, diskette • Serial port I/O control • Parallel port I/O control • USB port disablement 	
			<p>Supports ThinkVantage® technologies</p>	
			<p>RoHS-compliant</p>	
			<p>Limited Warranty¹</p> <ul style="list-style-type: none"> ↪ 1-year parts and labor ↪ International Warranty Service⁹ ↪ Customer Replaceable Unit (CRU) parts only (with limited onsite service for selected parts³, 8 am - 5 pm, Mon - Fri coverage excluding holidays, next business day response time) ↪ Onsite service upgrade options (in eligible locations)⁷ <ul style="list-style-type: none"> • 1-year LOR 9x5, 4 hour response (ThinkPlus™ part number 41C9189) • 2-year LOR 9x5, Next Business Day (ThinkPlus part number 41C9187) • 2-year LOR 9x5, 4 hour response (ThinkPlus part number 41C9190) • 3-year LOR 9x5, Next Business Day (ThinkPlus part number 41C9188) • 3-year LOR 9x5, 4 hour response (ThinkPlus part number 41C9191) ↪ ThinkPlus services at lenovo.com/thinkplus/warranty ↪ Post warranty maintenance services available ↪ 24 hour x 7 day¹⁴ toll-free support during the warranty period¹ via 800-426-7378 	

See footnotes for important warranty information
US models announced November 25, 2008

ThinkCentre® A57 Tower (9851) - TopSeller

Personal Systems Reference (PSREF)

Name	Type-model	Slot x bay	Processor	GHz	L2 cache	Core	Memory ⁶	SATA disk	2nd Disk Bay	SATA optical	Graphics	Preload	Limited warranty ¹	Global Educ	Avail date
A57	9851-B1U	4x4	Pentium E2180	2.00	1MB	Dual	512MB	80GB ²	None	DVD	GMA	XP Pro	3-yr	None	Mar 08
A57	9851-B2U	4x4	Pentium E2180	2.00	1MB	Dual	512MB	160GB	None	Combo	GMA	XP Pro	3-yr	None	Mar 08
A57	9851-B3U	4x4	Pentium E2180	2.00	1MB	Dual	1GB	160GB	None	DVD±RW	GMA	XP Pro	3-yr	None	Mar 08
A57	9851-A6U	4x4	Pentium E2200	2.20	1MB	Dual	1GB	160GB	None	Combo	GMA	XP Pro	3-yr	None	Mar 08
ES ³	A57	9851-BSU	Pentium E2200	2.20	1MB	Dual	2GB	160GB	None	DVD±RW	GMA	XP Pro	3-yr	None	Apr 08
A57	9851-B4U	4x4	Core 2 Duo E4600	2.40	2MB	Dual	1GB	160GB	None	Combo	GMA	XP Pro	3-yr	None	Mar 08
A57	9851-B5U	4x4	Core 2 Duo E4600	2.40	2MB	Dual	2GB	160GB	None	DVD±RW	GMA	XP Pro	3-yr	None	Mar 08
ES ³	A57	9851-A7U	Core 2 Duo E8200	2.66	6MB	Dual	1GB	160GB	None	DVD±RW	GMA	XP Pro	3-yr	None	Apr 08

• These small and medium business (SMB) models are part of the US TopSeller™ Program

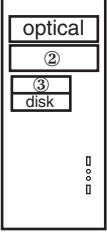
Positioning Processor	Quality, reliability, and security for small/medium businesses Intel® Pentium® Dual-Core Processor E2180 or E2200 with dual-core, Intel 64 Technology, Execute Disable Bit, EIST, 800MHz system bus, and 1MB shared L2 cache or Intel Core™ 2 Duo Processor E4600 with dual-core, Intel 64 Technology, Execute Disable Bit, EIST, 800MHz system bus, and 2MB shared L2 cache or Intel Core 2 Duo Processor E8200 with dual-core, Intel 64 Technology, Virtualization Technology, Execute Disable Bit, EIST, TXT, and 1333MHz system bus with 6MB shared L2 cache Processor in FC-LGA6 or FC-LGA8 package in LGA775 socket	Tower <ul style="list-style-type: none"> • Business black color; metal case • 6.9" W X 17.3" D X 15.8" H • 175mm W X 440mm D X 402mm H • 24.2 lb (11.0 kg) in max configuration • Handle on top front • Toolless cover removal • Toolless disk, diskette drive, optical drive removal • Toolless adapter retention 
Implementation		
Memory	512MB, 1GB, or 2GB std , 4GB max ⁸ , PC2-5300 667MHz DDR2 , non-parity, dual-channel capable, two 240-pin DIMM sockets; <i>Italics:</i> standard memory in both sockets; no sockets avail; <i>Non-italics:</i> standard memory in one socket; one socket available	Bay ① 5.25", 1.6" high, access, std optical Bay ② 5.25", 1.6" high, access, open Bay ③ 3.5", 1" high, access, open (reader/diskette) Bay ④ 3.5", 1" high, no access, std disk
Graphics	Intel Graphics Media Accelerator 3100 (GMA 3100) , integrated graphics in G31, uses main memory (up to 256MB), one analog VGA DB-15 connector, supports dual independent display with optional ADD2 adapter	Slot 1: half-length, full-height, PCI Express x16 (75w max) Slot 2: half-length, full-height, PCI Express x1 Slot 3: half-length, full-height, 32-bit PCI 2.3 Slot 4: half-length, full-height, 32-bit PCI 2.3
SATA disk	80GB or 160GB , SATA 3.0Gb/s 7200 rpm, vibration dampening mounts	<p align="center">Security</p> <ul style="list-style-type: none"> • One lock to secure both cover and entire system to fixed object: <ul style="list-style-type: none"> - Padlock loop (in rear for opt padlock) - Security slot (in rear for optional Kensington® Microsaver® cable) • Power-on password • Administrator password • Hard disk password • Boot sequence control • Boot without keyboard, mouse, diskette • Serial port I/O control • Parallel port I/O control • USB port disablement <p>Supports ThinkVantage® technologies</p> <p>RoHS-compliant</p> <p align="center">Limited Warranty¹</p> <ul style="list-style-type: none"> ↪ 3-year parts and labor ↪ International Warranty Service⁹ ↪ Customer Replaceable Unit (CRU) parts only (with limited onsite service for selected parts³, 8 am - 5 pm, Mon - Fri coverage excluding holidays, next business day response time) ↪ Onsite service upgrade options (in eligible locations):⁷ <ul style="list-style-type: none"> • 3-year LOR 9x5, 4 hour response (ThinkPlus™ part number 41C9192) • 3-year LOR 24x7, 4 hour response (ThinkPlus part number 41C9193) • 4-year LOR 9x5, Next Business Day (ThinkPlus part number 41C9194) • 4-year LOR 9x5, 4 hour response (ThinkPlus part number 41C9195) • 4-year LOR 24x7, 4 hour response (ThinkPlus part number 41C9196) ↪ ThinkPlus services at lenovo.com/thinkplus/warranty ↪ Post warranty maintenance services available ↪ 24 hour x 7 day¹⁴ toll-free support during the warranty period¹ via 800-426-7378
SATA controller	Serial ATA, SATA 3.0Gb/s, integrated in ICH7	
SATA DVD	<i>Some:</i> DVD-ROM DL SATA 1.5Gb/s 16X-48X Max ⁴ Drive (41N5618)	
SATA Combo	<i>Some:</i> CD-RW/DVD-ROM Combo SATA 1.5Gb/s Drive	
SATA DVD±RW	<i>Some:</i> Super Multi-Burner DL DVD±RW SATA 1.5Gb/s Drive (41N5620)	
SATA cables	Two SATA cables (each 1-drop to device), four SATA connectors on planar	
eSATA port	None	
EIDE controller	Enhanced IDE, ATA-100, integrated in ICH7, one EIDE connector on planar	
Diskette drive	None	
Media reader	None	
Chipset	Intel G31 Express Chipset ; I/O Controller Hub 7 (ICH7) for SATA 3.0Gb/s, ATA-100 EIDE, PCI Express [®] x1, PCI 2.3, USB, LPC bus / ITE Tech [®] IT8718 Super I/O for serial, parallel, keyboard, mouse functions	
Front ports	Two USB 2.0, microphone (stereo, 3.5mm), headphone (stereo, 3.5mm)	
Rear ports	Four USB 2.0, serial (9-pin), parallel (25-pin), keyboard (PS/2), mouse (PS/2), ethernet (RJ-45), monitor (VGA DB-15)	
Internal connector	Two USB 2.0 planar connectors (one used; one open for media reader)	
Rear audio ports	Line-in (stereo, 3.5mm), line-out (stereo, 3.5mm), microphone (stereo, 3.5mm)	
Audio	High Definition (HD) Audio, Realtek [®] ALC662 codec	
Speaker	One internal speaker for business audio	
Ethernet	Gigabit ethernet on planar, Marvell [®] 88E8056, PCIe x1, Wake on LAN [®]	
Intel AMT	None	
Modem	None	
Security chip	None	
Keyboard	Preferred Pro USB Keyboard (USB connector), 104-key, black, Lenovo logo	
Mouse	Optical Wheel Mouse (USB connector), 400 dpi, black, Lenovo logo	
Power supply	280 watts with variable speed fan, manual switch	
Preloaded operating system²⁰	Accessories	
- Microsoft® Windows® XP Professional with Vista® COA	1GB PC2-5300 DDR2 UDIMM (TopSeller)	43R2001
◆ Disk-to-Disk Recovery (in hidden protected area)	2GB PC2-5300 DDR2 UDIMM (TopSeller)	43R2002
	500GB SATA 3.0Gb/s (7200 rpm)	43R1990
	USB 2.0 Lenovo Multimedia Headset	40Y8518
	USB 2.0 Essential Memory Key 32GB	45K1258
	USB 2.0 Ultra Secure Memory Key 8GB	45J5918
	USB 2.0 Portable Secure 320GB Hard Disk	43R2019
	ThinkVision® L1940p Wide 19" Monitor	4424HB6
	ThinkVision L2240p Wide 22" Monitor	4422HB6
	ThinkVision L2440p Wide 24" Monitor	4420HB2
	Wireless Kbd & Opt Wheel Mouse (via USB)	73P4067
	Laser Tilt Wheel Mouse (USB, PS/2)	41U3074
	Kensington Cable Lock from Lenovo	73P2582
	ADD2 DVI-I PCIe Connection Adapter	73P2516
	ADD2 DVI-D Monitor Connection (HDCP)	43R1985
	ATI™ Radeon™ HD 2400 Pro 128MB	43R1961
	ATI Radeon HD 2400 XT 256MB	43R1962
	ATI Radeon HD 2600 XT 512MB	43R1963
	Acc Guide in pdf lenovo.com/accessoriesguide	
	Other accessories at lenovo.com/accessories	

See footnotes for important warranty information

ES³ US models announced March 18, 2008; previous models on February 26, 2008

© Lenovo (TUNS1-5) April 2008

Name	Type-model	Slot x bay	Processor	GHz	L2 cache	Core	Memory ⁹	SATA disk	2nd Disk Bay	SATA optical	Graphics	Vista preload	Vista logo	Global Educ	Avail date
☞	A57	9851-C4U	4x4	Pentium E2180	2.00	1MB	Dual 1GB	160GB ²	None	Combo	GMA	Business32	Basic	None	May 08
	A57	9851-BYU	4x4	Pentium E2180	2.00	1MB	Dual 2GB	160GB	None	DVD±RW	GMA	Business32	Premium	None	Apr 08
☞	A57	9851-C9U	4x4	Core 2 Duo E4600	2.40	2MB	Dual 1GB	160GB	None	Combo	GMA	Business32	Basic	None	May 08
	A57	9851-CCU	4x4	Core 2 Duo E4600	2.40	2MB	Dual 2GB	160GB	None	DVD±RW	GMA	Business32	Premium	None	Apr 08
	A57	9851-CDU	4x4	Core 2 Duo E8200	2.66	6MB	Dual 1GB	160GB	None	DVD±RW	GMA	Business32	Basic	None	Apr 08

- These small and medium business (SMB) models are part of the US TopSeller™ Program
- These models have a 3-year limited warranty¹

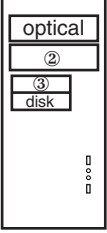
Positioning Processor	Quality, reliability, and security for small/medium businesses Intel® Pentium® Dual-Core Processor E2180 with dual-core, Intel 64 Technology, Execute Disable Bit, EIST, 800MHz system bus, and 1MB shared L2 cache or Intel Core™ 2 Duo Processor E4600 with dual-core, Intel 64 Technology, Execute Disable Bit, EIST, 800MHz system bus, and 2MB shared L2 cache or Intel Core 2 Duo Processor E8200 with dual-core, Intel 64 Technology, Virtualization Technology, Execute Disable Bit, EIST, TXT, and 1333MHz system bus with 6MB shared L2 cache Processor in FC-LGA6 or FC-LGA8 package in LGA775 socket										Tower <ul style="list-style-type: none"> • Business black color; metal case • 6.9" W X 17.3" D X 15.8" H • 175mm W X 440mm D X 402mm H • 24.2 lb (11.0 kg) in max configuration • Handle on top front • Toolless cover removal • Toolless disk, diskette drive, optical drive removal • Toolless adapter retention 																																											
Implementation											Bay ① 5.25", 1.6" high, access, std optical Bay ② 5.25", 1.6" high, access, open Bay ③ 3.5", 1" high, access, open (reader/diskette) Bay ④ 3.5", 1" high, no access, std disk																																											
Memory	1GB or 2GB std , 4GB max ⁸ , PC2-5300 667MHz DDR2 , non-parity, dual-channel capable, two 240-pin DIMM sockets; <i>Italics:</i> standard memory in both sockets; no sockets avail; <i>Non-italics:</i> standard memory in one socket; one socket available																																																					
Graphics	Intel Graphics Media Accelerator 3100 (GMA 3100) , integrated graphics in G31, uses main memory (up to 256MB), one analog VGA DB-15 connector, supports dual independent display with optional ADD2 adapter										Slot 1: half-length, full-height, PCI Express x16 (75w max) Slot 2: half-length, full-height, PCI Express x1 Slot 3: half-length, full-height, 32-bit PCI 2.3 Slot 4: half-length, full-height, 32-bit PCI 2.3																																											
SATA disk	160GB , SATA 3.0Gb/s 7200 rpm, vibration dampening mounts SATA controller Serial ATA, SATA 3.0Gb/s, integrated in ICH7 SATA Combo <i>Some:</i> CD-RW/DVD-ROM Combo SATA 1.5Gb/s Drive SATA DVD±RW <i>Some:</i> Super Multi-Burner DL DVD±RW SATA 1.5Gb/s Drive (41N5620) SATA cables Two SATA cables (each 1-drop to device), four SATA connectors on planar eSATA port None EIDE controller Enhanced IDE, ATA-100, integrated in ICH7, one EIDE connector on planar Diskette drive None Media reader None										Security <ul style="list-style-type: none"> • One lock to secure both cover and entire system to fixed object: <ul style="list-style-type: none"> - Padlock loop (in rear for opt padlock) - Security slot (in rear for optional Kensington® Microsaver® cable) • Power-on password • Administrator password • Hard disk password • Boot sequence control • Boot without keyboard, mouse, diskette • Serial port I/O control • Parallel port I/O control • USB port disablement 																																											
Chipset	Intel G31 Express Chipset ; I/O Controller Hub 7 (ICH7) for SATA 3.0Gb/s, ATA-100 EIDE, PCI Express® x1, PCI 2.3, USB, LPC bus / ITE Tech® IT8718 Super I/O for serial, parallel, keyboard, mouse functions										Supports ThinkVantage® technologies																																											
Front ports	Two USB 2.0, microphone (stereo, 3.5mm), headphone (stereo, 3.5mm)																																																					
Rear ports	Four USB 2.0, serial (9-pin), parallel (25-pin), keyboard (PS/2), mouse (PS/2), ethernet (RJ-45), monitor (VGA DB-15)																																																					
Internal connector	Two USB 2.0 planar connectors (one used; one open for media reader)																																																					
Rear audio ports	Line-in (stereo, 3.5mm), line-out (stereo, 3.5mm), microphone (stereo, 3.5mm)																																																					
Audio	High Definition (HD) Audio, Realtek® ALC662 codec																																																					
Speaker	One internal speaker for business audio																																																					
Ethernet	Gigabit ethernet on planar, Marvell® 88E8056, PCIe x1, Wake on LAN®																																																					
Intel AMT	None																																																					
Modem	None										RoHS-compliant																																											
Security chip	None																																																					
Keyboard	Preferred Pro USB Keyboard (USB connector), 104-key, black, Lenovo logo																																																					
Mouse	Optical Wheel Mouse (USB connector), 400 dpi, black, Lenovo logo																																																					
Power supply	280 watts with variable speed fan, manual switch																																																					
Preloaded operating system²⁰	- Microsoft® Windows® Vista Business Edition (32-bit)										Limited Warranty¹ <ul style="list-style-type: none"> ☞ 3-year parts and labor ☞ International Warranty Service⁹ ☞ Customer Replaceable Unit (CRU) parts only (with limited onsite service for selected parts³, 8 am - 5 pm, Mon - Fri coverage excluding holidays, next business day response time) ☞ Onsite service upgrade options (in eligible locations):⁷ <ul style="list-style-type: none"> • 3-year LOR 9x5, 4 hour response (ThinkPlus™ part number 41C9192) • 3-year LOR 24x7, 4 hour response (ThinkPlus part number 41C9193) • 4-year LOR 9x5, Next Business Day (ThinkPlus part number 41C9194) • 4-year LOR 9x5, 4 hour response (ThinkPlus part number 41C9195) • 4-year LOR 24x7, 4 hour response (ThinkPlus part number 41C9196) ☞ ThinkPlus services at lenovo.com/thinkplus/warranty ☞ Post warranty maintenance services available ☞ 24 hour x 7 day¹⁴ toll-free support during the warranty period¹ via 800-426-7378 																																											
Preloaded applications⁵	<ul style="list-style-type: none"> • Rescue and Recovery™ • Client Security Solution™ • ThinkVantage Productivity Center • ThinkVantage System Update • System Migration Assistant • Norton Internet Security™ (90 days of virus definitions) • Diskeeper® Home • PC-Doctor™ (diagnostics) • Adobe® Reader • Windows Live™ Toolbar • Windows Live Search • Picasa from Google • Microsoft Office 2007 Trial (60-day) • Sonic RecordNow and Drive Letter Access (combo, DVD±RW) • Corel® WinDVD® (combo, DVD±RW) 										Accessories <table border="0"> <tr><td>1GB PC2-5300 DDR2 UDIMM (TopSeller)</td><td>43R2001</td></tr> <tr><td>2GB PC2-5300 DDR2 UDIMM (TopSeller)</td><td>43R2002</td></tr> <tr><td>250GB SATA 3.0Gb/s Disk (7200 rpm)</td><td>41N3015</td></tr> <tr><td>500GB SATA 3.0Gb/s Disk (7200 rpm)</td><td>43R1990</td></tr> <tr><td>USB 2.0 Lenovo Multimedia Headset</td><td>40Y8518</td></tr> <tr><td>USB 2.0 Lenovo Webcam</td><td>40Y8519</td></tr> <tr><td>USB 2.0 Essential Memory Key 32GB</td><td>45K1258</td></tr> <tr><td>USB 2.0 Ultra Secure Memory Key 8GB</td><td>45J5918</td></tr> <tr><td>USB 2.0 Portable 160GB Hard Disk</td><td>43R1784</td></tr> <tr><td>USB 2.0 Portable Secure 320GB Hard Disk</td><td>43R2019</td></tr> <tr><td>ThinkVision® L1940p Wide 19" Monitor</td><td>4424HB6</td></tr> <tr><td>ThinkVision L2240p Wide 22" Monitor</td><td>4422HB6</td></tr> <tr><td>ThinkVision L2440p Wide 24" Monitor</td><td>4420HB2</td></tr> <tr><td>Wireless Kbd & Opt Wheel Mouse (via USB)</td><td>73P4067</td></tr> <tr><td>Laser Tilt Wheel Mouse (USB, PS/2)</td><td>41U3074</td></tr> <tr><td>Kensington Cable Lock from Lenovo</td><td>73P2582</td></tr> <tr><td>ADD2 DVI-I PCIe Connection Adapter</td><td>73P2516</td></tr> <tr><td>ADD2 DVI-D Monitor Connection (HDCP)</td><td>43R1985</td></tr> <tr><td>ATI™ Radeon™ HD 2400 Pro 128MB</td><td>43R1961</td></tr> <tr><td>ATI Radeon HD 2400 XT 256MB</td><td>43R1962</td></tr> <tr><td>ATI Radeon HD 2600 XT 512MB</td><td>43R1963</td></tr> </table> Acc Guide in pdf lenovo.com/accessoriesguide Other accessories at lenovo.com/accessories		1GB PC2-5300 DDR2 UDIMM (TopSeller)	43R2001	2GB PC2-5300 DDR2 UDIMM (TopSeller)	43R2002	250GB SATA 3.0Gb/s Disk (7200 rpm)	41N3015	500GB SATA 3.0Gb/s Disk (7200 rpm)	43R1990	USB 2.0 Lenovo Multimedia Headset	40Y8518	USB 2.0 Lenovo Webcam	40Y8519	USB 2.0 Essential Memory Key 32GB	45K1258	USB 2.0 Ultra Secure Memory Key 8GB	45J5918	USB 2.0 Portable 160GB Hard Disk	43R1784	USB 2.0 Portable Secure 320GB Hard Disk	43R2019	ThinkVision® L1940p Wide 19" Monitor	4424HB6	ThinkVision L2240p Wide 22" Monitor	4422HB6	ThinkVision L2440p Wide 24" Monitor	4420HB2	Wireless Kbd & Opt Wheel Mouse (via USB)	73P4067	Laser Tilt Wheel Mouse (USB, PS/2)	41U3074	Kensington Cable Lock from Lenovo	73P2582	ADD2 DVI-I PCIe Connection Adapter	73P2516	ADD2 DVI-D Monitor Connection (HDCP)	43R1985	ATI™ Radeon™ HD 2400 Pro 128MB	43R1961	ATI Radeon HD 2400 XT 256MB	43R1962	ATI Radeon HD 2600 XT 512MB	43R1963
1GB PC2-5300 DDR2 UDIMM (TopSeller)	43R2001																																																					
2GB PC2-5300 DDR2 UDIMM (TopSeller)	43R2002																																																					
250GB SATA 3.0Gb/s Disk (7200 rpm)	41N3015																																																					
500GB SATA 3.0Gb/s Disk (7200 rpm)	43R1990																																																					
USB 2.0 Lenovo Multimedia Headset	40Y8518																																																					
USB 2.0 Lenovo Webcam	40Y8519																																																					
USB 2.0 Essential Memory Key 32GB	45K1258																																																					
USB 2.0 Ultra Secure Memory Key 8GB	45J5918																																																					
USB 2.0 Portable 160GB Hard Disk	43R1784																																																					
USB 2.0 Portable Secure 320GB Hard Disk	43R2019																																																					
ThinkVision® L1940p Wide 19" Monitor	4424HB6																																																					
ThinkVision L2240p Wide 22" Monitor	4422HB6																																																					
ThinkVision L2440p Wide 24" Monitor	4420HB2																																																					
Wireless Kbd & Opt Wheel Mouse (via USB)	73P4067																																																					
Laser Tilt Wheel Mouse (USB, PS/2)	41U3074																																																					
Kensington Cable Lock from Lenovo	73P2582																																																					
ADD2 DVI-I PCIe Connection Adapter	73P2516																																																					
ADD2 DVI-D Monitor Connection (HDCP)	43R1985																																																					
ATI™ Radeon™ HD 2400 Pro 128MB	43R1961																																																					
ATI Radeon HD 2400 XT 256MB	43R1962																																																					
ATI Radeon HD 2600 XT 512MB	43R1963																																																					

See footnotes for important warranty information

☞ US models announced April 29, 2008; previous models on April 8, 2008

Partial list of accessories supported on ThinkCentre A57

Memory

512MB PC2-5300 CL5 NP DDR2 UDIMM	73P4983	ann 06/28/05
1GB PC2-5300 DDR2 UDIMM (TopSeller)	43R2001	ann 03/25/08
1GB PC2-5300 CL5 NP DDR2 UDIMM	73P4984	ann 06/28/05
2GB PC2-5300 DDR2 UDIMM (TopSeller)	43R2002	ann 03/25/08
2GB PC2-5300 CL5 NP DDR2 UDIMM	73P4985	ann 09/26/06
512MB PC2-6400 NP DDR2 UDIMM ⁴⁸	41U2976	ann 09/26/06
1GB PC2-6400 NP DDR2 UDIMM ⁴⁸	41U2977	ann 09/26/06
2GB PC2-6400 NP DDR2 UDIMM ⁴⁸	41U2978	ann 01/08/08

⁴⁸ When PC2-6400 is installed with systems that have PC2-5300 memory, PC2-6400 will operate at the PC2-5300 memory speed.

Optical

DVD-ROM DL SATA 1.5Gb/s 16X-48X Max ⁴	41N5618	ann 09/26/06
Super Multi-Burner DL DVD±RW SATA Drive	41N5620	ann 09/26/06

Storage and removable storage

80GB SATA 3.0Gb/s Disk (7200 rpm)	09N4253	ann 05/19/03
160GB SATA 3.0Gb/s Disk (7200 rpm)	09N4254	ann 05/19/03
250GB SATA 3.0Gb/s Disk (7200 rpm)	41N3015	ann 01/24/06
500GB SATA 3.0Gb/s Disk (7200 rpm)	43R1990	ann 11/06/07

USB Portable Diskette Drive	05K9276	ann 06/05/00
USB 2.0 Essential Memory Key 1GB	41U4940	ann 01/23/07
USB 2.0 Essential Memory Key 2GB	41U4944	ann 01/23/07
USB 2.0 Essential Memory Key 4GB	45J7904	ann 06/24/08
USB 2.0 Essential Memory Key 8GB	45J7905	ann 07/15/08
USB 2.0 Essential Memory Key 32GB	45K1258	ann 10/28/08
USB 2.0 Security Memory Key 1GB	41U5118	ann 07/17/07
USB 2.0 Security Memory Key 2GB	41U5119	ann 07/17/07
USB 2.0 Security Memory Key 4GB	41U5120	ann 07/17/07
USB 2.0 Ultra Secure Memory Key 1GB	45J5915	ann 08/26/08
USB 2.0 Ultra Secure Memory Key 2GB	45J5916	ann 08/26/08
USB 2.0 Ultra Secure Memory Key 4GB	45J5917	ann 08/26/08
USB 2.0 Ultra Secure Memory Key 8GB	45J5918	ann 08/26/08
USB 2.0 Portable 160GB Hard Disk	43R1784	ann 09/23/08
USB 2.0 Portable Secure 160GB Hard Disk	43R2018	ann 11/18/08
USB 2.0 Portable Secure 320GB Hard Disk	43R2019	ann 11/18/08
USB 2.0 CD-RW/DVD-ROM Combo II Drive	40Y8637	ann 01/05/06
USB 2.0 Super Multi-Burner Drive	41N5565	ann 01/23/07

Graphics

Small 9704 supports Low Profile 35 watts max:

ADD2 DVI-I PCIe Connection Adapter	73P2516	ann 06/28/05
ADD2 DVI-D Monitor Connection (HDCP)	43R1985	ann 11/06/07
ATI™ Radeon™ HD 2400 Pro 128MB	43R1961	ann 11/06/07
ATI Radeon HD 2400 XT 256MB	43R1962	ann 11/06/07

Tower 9702/9851 support 75 watts max:

ADD2 DVI-I PCIe Connection Adapter	73P2516	ann 06/28/05
ADD2 DVI-D Monitor Connection (HDCP)	43R1985	ann 11/06/07
ATI Radeon HD 2400 Pro 128MB	43R1961	ann 11/06/07
ATI Radeon HD 2400 XT 256MB	43R1962	ann 11/06/07
ATI Radeon HD 2600 XT 512MB	43R1963	ann 11/06/07

More information at www.lenovo.com/support/graphiccards

Keyboard

Preferred Pro USB Keyboard	73P5220	ann 06/21/05
Preferred Pro Full Size PS/2 Keyboard	31P7415	ann 06/04/02
Enhanced Performance USB Keyboard	73P2620	ann 03/23/04
Wireless Kbd & Opt Wheel Mouse (via USB)	73P4067	ann 12/07/04
Lenovo USB Fingerprint Keyboard	73P4730	ann 02/22/05

More information at www.lenovo.com/support/keyboards

Mouse

Optical Wheel Mouse (USB)	06P4069	ann 05/21/03
Optical ScrollPoint® Mouse (USB, PS/2)	31P7405	ann 08/27/02
Laser Tilt Wheel Mouse (USB, PS/2)	41U3074	ann 01/23/07
Lenovo Wireless Laser Mouse (blk, via USB)	45K1696	ann 11/25/08
Lenovo Wireless Laser Mouse (red, via USB)	51J0198	ann 11/25/08

More information at www.lenovo.com/support/mice

Multimedia

USB 2.0 Lenovo Multimedia Headset	40Y8518	ann 06/27/06
USB 2.0 Lenovo Webcam	40Y8519	ann 08/29/06

Security

Kensington® Cable Lock from Lenovo	73P2582	ann 12/29/03
Kensington Twin Head Cable Lock	45K1620	ann 09/30/08
USB Gemplus GemPC Smart Card Reader	41N3040	ann 02/21/06

Monitors

ThinkVision® L174 17" Monitor	9227AE1	ann 04/15/08
ThinkVision L1700p 17" Monitor	9417HE2	ann 09/17/08
ThinkVision L1900p 19" Monitor	4431HE1	ann 11/11/08
ThinkVision L1940p Wide 19" Monitor	4424HB6	ann 09/17/08
ThinkVision L200p Wide 20.1" Monitor	4438HB6	ann 04/15/08
ThinkVision L2240p Wide 22" Monitor	4422HB6	ann 09/17/08
ThinkVision L2440p Wide 24" Monitor	4420HB2	ann 09/17/08
ThinkVision L2440x Wide 24" Monitor	4421HB2	ann 09/17/08

More information at www.lenovo.com/thinkvision

Monitor Accessories⁴⁶

ThinkVision USB Soundbar	40Y7616	ann 08/23/05
ThinkVision Soundbar (L1900p, 24" Wide)	45K1263	ann 09/16/08
Kensington Cable Lock from Lenovo	73P2582	ann 12/29/03
Kensington Twin Head Cable Lock	45K1620	ann 09/30/08
Radial Arm	19K4464	ann 05/05/00

⁴⁶ Compatible on selected Lenovo and ThinkVision monitors.

More information at www.lenovo.com/support/monitoraccessories

Medialess License Key (MLK)

Microsoft® Office 2007 Basic, English	43R1528	ann 01/31/07
Microsoft Office 2007 Small Business, Engl	43R1534	ann 01/31/07
Microsoft Office 2007 Professional, English	43R1531	ann 01/31/07

Other accessories at www.lenovo.com/accessories

Accessories Guide pdf at www.lenovo.com/accessoriesguide



Lenovo ThinkCentre A62 Desktop with four Lenovo ThinkVision monitors



Lenovo ThinkCentre A62 Tower



Lenovo ThinkCentre A62 Desktop



Lenovo ThinkCentre A62 Tower and Lenovo ThinkCentre A62 Desktop



Lenovo ThinkCentre A62 Desktop with Lenovo ThinkVision L193p monitor



Lenovo ThinkCentre A62 Tower with Lenovo ThinkVision L193p monitor

Name	Type-model	Slot x bay	AMD processor	GHz	Core	Memory ⁶	SATA disk	SATA optical	Graphics	Monitor connectors	Preload	Global Educ	Avail date
A62	9486-F1U	4x3	Athlon 1640B	2.7	Single	1GB	160GB ²	DVD	3100	VGA, DVI-D	XP Pro	None	Sep 08
A62	9486-F2U	4x3	Athlon X2 5000B	2.6	Dual	1GB	160GB	DVD	3100	VGA, DVI-D	XP Pro	None	Sep 08
A62	9486-F3U	4x3	Athlon X2 5000B	2.6	Dual	1GB	160GB	DVD±RW	3100	VGA, DVI-D	XP Pro	None	Sep 08
A62	9486-F4U	4x3	Athlon X2 5000B	2.6	Dual	2GB	160GB	DVD±RW	3100	VGA, DVI-D	XP Pro	None	Sep 08
A62	9486-F5U	4x3	Athlon X2 5000B	2.6	Dual	2GB	250GB	DVD±RW	9300GE	DVI-I	XP Pro	None	Sep 08
A62	9486-F6U	4x3	Athlon X2 5400B	2.8	Dual	1GB	160GB	DVD	3100	VGA, DVI-D	XP Pro	None	Sep 08
A62	9486-F7U	4x3	Athlon X2 5400B	2.8	Dual	2GB	250GB	DVD±RW	3100	VGA, DVI-D	XP Pro	None	Sep 08
A62	9486-F8U	4x3	Phenom X3 8450	2.1	Triple	1GB	250GB	DVD	3100	VGA, DVI-D	XP Pro	None	Sep 08
A62	9486-F9U	4x3	Phenom X3 8450	2.1	Triple	2GB	160GB	DVD±RW	9300GE	DVI-I	XP Pro	None	Sep 08

• These models have a 3-year limited warranty¹

Positioning Processor	<p><i>Stability and manageability for large enterprise and mid-market</i> AMD® Athlon™ Processor 1640B with single-core, virtualization technology, int DDR2 memory controller, and 512KB L2 cache or AMD Athlon X2 Dual-Core Processor 5000B or 5400B with dual-core, virtualization technology, integrated DDR2 memory controller, and 1MB dedicated L2 cache or AMD Phenom™ X3 Triple-Core Processor 8450 with triple-core, virtualization technology, integrated DDR2 memory controller, 1.5MB dedicated L2 cache and 2MB shared L3 cache Processor in Socket AM2 or AM2+</p>		<p>Desktop</p> <ul style="list-style-type: none"> • Business black color • 13.0" W X 16.2" D X 4.1" H • 331mm W X 412mm D X 104mm H • 19.4lb (8.8kg) in typical configuration • Toolless cover removal • Toolless disk, diskette drive, optical drive removal • Toolless adapter retention <p>Bay ① 5.25", 1.6" high, access, std optical Bay ② 3.5", 1" high, access, open* Bay ③ 3.5", 1" high, no access, std disk</p> <p>* supports reader/diskette/2nd disk</p> <p>Slot 1: Low Profile, PCI Express 2.0 x1 Slot 2: Low Profile, PCI Express 2.0 x16 (35w max)** Slot 3: Low Profile, 32-bit PCI 2.3 Slot 4: Low Profile, 32-bit PCI 2.3</p> <p>** used in some models</p>
Implementation			<p>Security</p> <ul style="list-style-type: none"> • Security chip (see information on left) • One lock to secure both cover and entire system to fixed object: <ul style="list-style-type: none"> - Padlock loop (in rear for opt padlock) - Security slot (in rear for optional Kensington® Microsaver® cable) • Power-on password • Administrator password • Hard disk password • Boot sequence control • Boot without keyboard, mouse, diskette • Serial port I/O control • Parallel port I/O control • Individual USB port disablement
Memory	<p>1GB or 2GB std., 8GB max⁸, four 240-pin DIMM sockets; <i>Italics:</i> standard memory in two sockets; two sockets available; <i>Non-italics:</i> standard memory in one socket; three sockets available; F8U/F9U: PC2-5300 667MHz DDR2, non-parity, dual-channel; <i>Others:</i> PC2-6400 800MHz DDR2, non-parity, dual-channel</p>		<p>Supports ThinkVantage® technologies</p>
Graphics	<p><i>Some:</i> ATI™ Radeon™ 3100, int graphics in 780V, uses main memory (up to 512MB), one analog VGA DB-15 connector, one DVI-D conn, DirectX® 10, ATI Avivo™, SurroundView™, supports dual independent display; supports up to 4 monitors with optional dual-head ATI graphics adapter</p> <p><i>Some:</i> NVIDIA® GeForce® 9300 GE, PCI Express® x16 adapter, 256MB, one DVI-I connector (includes DVI-to-VGA dongle), S-Video out for TV-out, HDCP, DirectX 10, 30 watts</p>		<p>GREENGUARD® certified RoHS-compliant</p>
SATA disk	<p>160GB or 250GB, SATA 3.0Gb/s 7200 rpm, vibration dampening mounts</p>		<p>Limited Warranty¹</p> <ul style="list-style-type: none"> ↪ 3-year parts and labor ↪ International Warranty Service⁹ ↪ Customer Replaceable Unit (CRU) parts only (with limited onsite service for selected parts³, 8 am - 5 pm, Mon - Fri coverage excluding holidays, next business day response time) ↪ Onsite service upgrade options (in eligible locations):⁷ <ul style="list-style-type: none"> • 3-year LOR 9x5, 4 hour response (ThinkPlus™ part number 41C9192) • 3-year LOR 24x7, 4 hour response (ThinkPlus part number 41C9193) • 4-year LOR 9x5, Next Business Day (ThinkPlus part number 41C9194) • 4-year LOR 9x5, 4 hour response (ThinkPlus part number 41C9195) • 4-year LOR 24x7, 4 hour response (ThinkPlus part number 41C9196) ↪ ThinkPlus services at lenovo.com/thinkplus/warranty ↪ 24 hour x 7 day¹⁴ toll-free support during the warranty period¹ via 800-426-7378
SATA controller	<p>Serial ATA, SATA 3.0Gb/s, integrated in SB700, RAID 0/1 support</p>		
SATA DVD	<p><i>Some:</i> DVD-ROM DL SATA 1.5Gb/s 16X-48X Max⁴ Drive (41N5618)</p>		
SATA DVD±RW	<p><i>Some:</i> Super Multi-Burner DL DVD±RW SATA 1.5Gb/s Drive (41N5620)</p>		
SATA cables	<p>Two SATA cables (each 1-drop to device), four SATA connectors on planar</p>		
eSATA port	None		
EIDE controller	None		
Diskette drive	None		
Media reader	None		
Chipset	<p>AMD 780V Chipset with HyperTransport™ 3.0 and PCI Express 2.0 support; SB700 south bridge for SATA 3.0Gb/s with RAID 0/1 support, ATA-133 EIDE, PCI 2.3, USB, LPC bus / Winbond® W83627DHG Super I/O</p>		
Front ports	Two USB 2.0, microphone (stereo, 3.5mm), headphone (stereo, 3.5mm)		
Rear ports	Six USB 2.0, serial (9-pin), parallel (25-pin), keyboard (PS/2), mouse (PS/2), ethernet (RJ-45), F5U/F9U: monitor (DVI-I), S-Video out; Others: monitor (VGA DB-15, DVI-D)		
Internal connector	Two USB 2.0 planar conn (1 used; one open for media reader or 2 rear USB ports)		
Rear audio ports	Line-in (stereo, 3.5mm), line-out (stereo, 3.5mm), microphone-in (stereo, 3.5mm)		
Audio	High Definition (HD) Audio, Realtek® ALC662 codec		
Speaker	One internal speaker for business audio		
Ethernet	Gigabit ethernet on planar, Marvell® 88E8070, Wake on LAN®, ASF 2.0		
Modem	None		
Security chip	Winbond WPCT200 SafeKeeper™ Trusted Platform Module, TCG 1.2-compliant		
Keyboard	Preferred Pro USB Keyboard (USB connector), 104-key, black, Lenovo logo		
Mouse	Optical Wheel Mouse (USB connector), 400dpi, black, Lenovo logo		
Power supply	220 watts with variable speed fan, manual switch		
Preloaded operating system²⁰	<p>- Microsoft® Windows® XP Professional with Vista® COA</p> <p>↪ Disk-to-Disk Recovery (in hidden protected area)</p> <p>↪ Vista Basic logo</p>		
Preloaded applications⁵ (only some listed)	<p>• Rescue and Recovery™</p> <p>• Client Security Solution™</p> <p>• Microsoft Office 2007 Trial (60-day)</p> <p>• Multimedia Center for Think Offerings (DVD, DVD±RW)</p> <p>• Sonic RecordNow and Drive Letter Access (DVD±RW)</p> <p>• Corel® WinDVD® (DVD, DVD±RW)</p> <p>• Corel WinDVD Creator (DVD±RW)</p>		
Accessories	<p>1GB PC2-5300 CL5 NP DDR2 UDIMM 73P4984</p> <p>2GB PC2-5300 CL5 NP DDR2 UDIMM 73P4985</p> <p>1GB PC2-6400 NP DDR2 UDIMM 41U2977</p> <p>2GB PC2-6400 NP DDR2 UDIMM 41U2978</p> <p>500GB SATA 3.0Gb/s Disk (7200 rpm) 43R1990</p> <p>USB 2.0 Lenovo Multimedia Headset 40Y8518</p> <p>USB 2.0 Lenovo Webcam 40Y8519</p> <p>USB 2.0 Ultra Secure Memory Key 8GB 45J5918</p> <p>ThinkVision® L2440p Wide 24" Monitor 4420HB2</p> <p>Wireless Kbd & Opt Wheel Mouse (via USB) 73P4067</p> <p>Laser Tilt Wheel Mouse (USB, PS/2) 41U3074</p> <p>Kensington Cable Lock from Lenovo 73P2582</p> <p>ATI Radeon HD 2400 XT 256MB 43R1962</p> <p>ATI Radeon HD 3470 256MB (DP, VGA) 45K1636</p> <p>Other accessories at lenovo.com/accessories</p>		

See footnotes for important warranty information
 US models announced September 9, 2008

Name	Type-model	Slot x bay	AMD processor	GHz	Core	Memory ⁶	SATA disk	SATA optical	Graphics	Monitor connectors	Vista preload	Global Educ	Avail date
A62	9486-E6U	4x3	Sempron LE-1300	2.3	Single	1GB	160GB ²	DVD±RW	3100	VGA, DVI-D	Business32	Educ	Sep 08
A62	9486-A4U	4x3	Athlon 1640B	2.7	Single	1GB	160GB	DVD	3100	VGA, DVI-D	Business32		Sep 08
A62	9486-H9U	4x3	Athlon X2 4450B	2.3	Dual	1GB	160GB	DVD±RW	3100	VGA, DVI-D	Business32	Educ	Sep 08
A62	9486-H8U	4x3	Athlon X2 4450B	2.3	Dual	2GB	160GB	DVD±RW	3100	VGA, DVI-D	Business32		Sep 08
A62	9486-H7U	4x3	Athlon X2 4450B	2.3	Dual	1GB	160GB	DVD	3100	VGA, DVI-D	Business32		Sep 08
A62	9486-H6U	4x3	Athlon X2 4450B	2.3	Dual	1GB	160GB	DVD±RW	3100GE	DVI-I	Business32		Sep 08
A62	9486-A3U	4x3	Athlon X2 5000B	2.6	Dual	1GB	160GB	DVD±RW	3100	VGA, DVI-D	Business32		Sep 08
A62	9486-A1U	4x3	Athlon X2 5400B	2.8	Dual	2GB	160GB	DVD±RW	3100	VGA, DVI-D	Business32		Sep 08
A62	9486-A2U	4x3	Phenom X3 8600B	2.3	Triple	2GB	160GB	DVD±RW	3100	VGA, DVI-D	Business64		Sep 08

• These models have a 3-year limited warranty¹

Positioning Processor	<p><i>Stability and manageability for large enterprise and mid-market</i></p> <p>AMD® Sempron™ Processor LE-1300 with single-core, integrated DDR2 memory controller, and 512KB L2 cache or AMD Athlon™ Processor 1640B with single-core, virtualization technology, int DDR2 memory controller, and 512KB L2 cache or AMD Athlon X2 Dual-Core Processor 4450B, 5000B, or 5400B with dual-core, virtualization technology, integrated DDR2 memory controller, and 1MB dedicated L2 cache or AMD Phenom™ X3 Triple-Core Processor 8600B with triple-core, virtualization technology, integrated DDR2 memory controller, 1.5MB dedicated L2 cache and 2MB shared L3 cache Processor in Socket AM2 or AM2+</p>	<p>Desktop</p> <ul style="list-style-type: none"> • Business black color • 13.0" W X 16.2" D X 4.1" H • 331mm W X 412mm D X 104mm H • 19.4lb (8.8kg) in typical configuration • Toolless cover removal • Toolless disk, diskette drive, optical drive removal • Toolless adapter retention <p>Bay ① 5.25", 1.6" high, access, std optical Bay ② 3.5", 1" high, access, open* Bay ③ 3.5", 1" high, no access, std disk</p> <p>* supports reader/diskette/2nd disk</p> <p>Slot 1: Low Profile, PCI Express 2.0 x1 Slot 2: Low Profile, PCI Express 2.0 x16 (35w max)** Slot 3: Low Profile, 32-bit PCI 2.3 Slot 4: Low Profile, 32-bit PCI 2.3</p> <p>** used in some models</p>
Implementation		
Memory	<p>1GB or 2GB std, 8GB max⁸, four 240-pin DIMM sockets;</p> <p><i>Italics:</i> standard memory in two sockets; two sockets available; <i>Non-italics:</i> standard memory in one socket; three sockets available; H8U/H9U: PC2-5300 667MHz DDR2, non-parity, dual-channel; Others: PC2-6400 800MHz DDR2, non-parity, dual-channel</p>	
Graphics	<p><i>Some:</i> ATI™ Radeon™ 3100, integrated graphics in 780V, uses main memory (up to 512MB), one analog VGA DB-15 connector, one DVI-D connector, DirectX® 10, ATI Avivo™, SurroundView™, supports dual independent display; supports up to 4 monitors with optional dual-head ATI graphics adapter</p> <p><i>Some:</i> NVIDIA® GeForce® 9300 GE, PCI Express® x16 adapter, 256MB, one DVI-I connector (includes DVI-to-VGA dongle), S-Video out for TV-out, HDCP, DirectX 10, 30 watts</p>	<p>Security</p> <ul style="list-style-type: none"> • Security chip (see information on left) • One lock to secure both cover and entire system to fixed object: <ul style="list-style-type: none"> - Padlock loop (in rear for opt padlock) - Security slot (in rear for optional Kensington® Microsaver® cable) • Power-on password • Administrator password • Hard disk password • Boot sequence control • Boot without keyboard, mouse, diskette • Serial port I/O control • Parallel port I/O control • Individual USB port disablement
SATA disk	160GB , SATA 3.0Gb/s 7200 rpm, vibration dampening mounts	
SATA controller	Serial ATA, SATA 3.0Gb/s, integrated in SB700, RAID 0/1 support	
SATA DVD	<i>Some:</i> DVD-ROM DL SATA 1.5Gb/s 16X-48X Max ⁴ Drive (41N5618)	
SATA DVD±RW	<i>Some:</i> Super Multi-Burner DL DVD±RW SATA 1.5Gb/s Drive (41N5620)	
SATA cables	Two SATA cables (each 1-drop to device), four SATA connectors on planar	
eSATA port	None	
EIDE controller	None	
Diskette drive	None	
Media reader	None	
Chipset	AMD 780V Chipset with HyperTransport™ 3.0 and PCI Express 2.0 support; SB700 south bridge for SATA 3.0Gb/s with RAID 0/1 support, ATA-133 EIDE, PCI 2.3, USB, LPC bus / Winbond® W83627DHG Super I/O	
Front ports	Two USB 2.0, microphone (stereo, 3.5mm), headphone (stereo, 3.5mm)	Supports ThinkVantage® technologies
Rear ports	Six USB 2.0, serial (9-pin), parallel (25-pin), keyboard (PS/2), mouse (PS/2), ethernet (RJ-45), H6U: monitor (DVI-I), S-Video out; Others: monitor (VGA DB-15, DVI-D)	GREENGUARD® certified RoHS-compliant
Internal connector	Two USB 2.0 planar conn (1 used; one open for media reader or 2 rear USB ports)	<p>Limited Warranty¹</p> <ul style="list-style-type: none"> ↪ 3-year parts and labor ↪ International Warranty Service⁹ ↪ Customer Replaceable Unit (CRU) parts only (with limited onsite service for selected parts³, 8 am - 5 pm, Mon - Fri coverage excluding holidays, next business day response time) ↪ Onsite service upgrade options (in eligible locations):⁷ <ul style="list-style-type: none"> • 3-year LOR 9x5, 4 hour response (ThinkPlus™ part number 41C9192) • 3-year LOR 24x7, 4 hour response (ThinkPlus part number 41C9193) • 4-year LOR 9x5, Next Business Day (ThinkPlus part number 41C9194) • 4-year LOR 9x5, 4 hour response (ThinkPlus part number 41C9195) • 4-year LOR 24x7, 4 hour response (ThinkPlus part number 41C9196) ↪ ThinkPlus services at lenovo.com/thinkplus/warranty ↪ 24 hour x 7 day¹⁴ toll-free support during the warranty period¹ via 800-426-7378
Rear audio ports	Line-in (stereo, 3.5mm), line-out (stereo, 3.5mm), microphone-in (stereo, 3.5mm)	
Audio	High Definition (HD) Audio, Realtek® ALC662 codec	
Speaker	One internal speaker for business audio	
Ethernet	Gigabit ethernet on planar, Marvell® 88E8070, Wake on LAN®, ASF 2.0	
Modem	None	
Security chip	Winbond WPCT200 SafeKeeper™ Trusted Platform Module, TCG 1.2-compliant	
Keyboard	Preferred Pro USB Keyboard (USB connector), 104-key, black, Lenovo logo	
Mouse	Optical Wheel Mouse (USB connector), 400dpi, black, Lenovo logo	
Power supply	220 watts with variable speed fan, manual switch	
Preloaded operating system²⁰	Accessories	
- <i>Some:</i> Microsoft® Windows® Vista Business Edition (32-bit)	1GB PC2-5300 CL5 NP DDR2 UDIMM	73P4984
- <i>Some:</i> Microsoft Windows Vista Business Edition (64-bit)	2GB PC2-5300 CL5 NP DDR2 UDIMM	73P4985
↕ Vista Premium logo	1GB PC2-6400 NP DDR2 UDIMM	41U2977
Preloaded applications⁵ (all OSes; only some listed)	2GB PC2-6400 NP DDR2 UDIMM	41U2978
• Rescue and Recovery™	USB 2.0 Lenovo Multimedia Headset	40Y8518
• Client Security Solution™	USB 2.0 Lenovo Webcam	40Y8519
• ThinkVantage Productivity Center	USB 2.0 Ultra Secure Memory Key 8GB	45J5918
• ThinkVantage System Update	ThinkVision® L2440p Wide 24" Monitor	4420HB2
• Norton Internet Security™	Wireless Kbd & Opt Wheel Mouse (via USB)	73P4067
• Microsoft Office 2007 Trial (60-day)	Kensington Cable Lock from Lenovo	73P2582
	ATI Radeon HD 2400 XT 256MB	43R1962
	ATI Radeon HD 3470 256MB (DP, VGA)	45K1636
	Other accessories at lenovo.com/accessories	

See footnotes for important warranty information

Ⓜ US models announced September 9, 2008; previous models on August 12, 2008

ThinkCentre® A62 Desktop (7057) - ENERGY STAR® 4.0

Personal Systems Reference (PSREF)

Name	Type-model	Slot x bay	AMD processor	GHz	Core	Memory ^d	SATA disk	SATA optical	Integrated graphics	Monitor connectors	ENERGY STAR 4.0	Preload	Global Educ	Avail date
A62	7057-B5U	4x3	Athlon X2 5000B	2.6	Dual	1GB	160GB ²	DVD	3100	VGA, DVI-D	ES40	XP Pro	None	Sep 08
A62	7057-B6U	4x3	Athlon X2 5000B	2.6	Dual	2GB	160GB	DVD±RW	3100	VGA, DVI-D	ES40	XP Pro	None	Sep 08
A62	7057-B7U	4x3	Athlon X2 5400B	2.8	Dual	2GB	250GB	DVD±RW	3100	VGA, DVI-D	ES40	XP Pro	None	Sep 08
ES A62	7057-B8U	4x3	Phenom X3 8450	2.1	Triple	1GB	160GB	DVD	3100	VGA, DVI-D	ES40	XP Pro	None	Dec 08
A62	7057-A3U	4x3	Athlon 1640B	2.7	Single	1GB	160GB	DVD	3100	VGA, DVI-D	ES40	Bus32	None	Sep 08
A62	7057-BBU	4x3	Athlon X2 4450B	2.3	Dual	1GB	160GB	DVD	3100	VGA, DVI-D	ES40	Bus32	None	Sep 08
A62	7057-A2U	4x3	Athlon X2 5000B	2.6	Dual	1GB	160GB	DVD±RW	3100	VGA, DVI-D	ES40	Bus32	None	Sep 08
ES A62	7057-A1U	4x3	Phenom X3 8600B	2.3	Triple	2GB	160GB	DVD±RW	3100	VGA, DVI-D	ES40	Bus64	None	Dec 08

• These models have a 3-year limited warranty¹

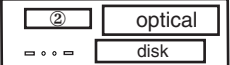
Positioning Processor	Stability and manageability for large enterprise and mid-market AMD® Athlon™ Processor 1640B with single-core, virtualization technology, int DDR2 memory controller, and 512KB L2 cache or AMD Athlon X2 Dual-Core Processor 4450B, 5000B, or 5400B with dual-core , virtualization technology, integrated DDR2 memory controller, and 1MB dedicated L2 cache or AMD Phenom™ X3 Triple-Core Processor 8450 or 8600B with triple-core , virtualization technology, integrated DDR2 memory controller, 1.5MB dedicated L2 cache and 2MB shared L3 cache Processor in Socket AM2 or AM2+		Desktop  <ul style="list-style-type: none"> • Business black color • 13.0" W X 16.2" D X 4.1" H • 331mm W X 412mm D X 104mm H • 19.4lb (8.8kg) in typical configuration • Toolless cover removal • Toolless disk, diskette drive, optical drive removal • Toolless adapter retention 																																																														
Implementation	1GB or 2GB std. , 8GB max ⁸ , four 240-pin DIMM sockets; <i>Italics:</i> standard memory in two sockets; two sockets available; <i>Non-italics:</i> standard memory in one socket; three sockets available; <i>Others:</i> PC2-5300 667MHz DDR2 , non-parity, dual-channel capable; <i>Axx:</i> PC2-6400 800MHz DDR2 , non-parity, dual-channel capable		Bay ① 5.25", 1.6" high, access, std optical Bay ② 3.5", 1" high, access, open* Bay ③ 3.5", 1" high, no access, std disk * supports reader/diskette/2nd disk																																																														
Memory	ATI™ Radeon™ 3100 , integrated graphics in 780V, uses main memory (up to 512MB), one analog VGA DB-15 connector, one DVI-D connector, DirectX® 10, ATI Avivo™, SurroundView™, supports dual independent display; supports up to 4 independent monitors with optional dual-head ATI graphics adapter		Slot 1: Low Profile, PCI Express 2.0 x1 Slot 2: Low Profile, PCI Express 2.0 x16 (35w max) Slot 3: Low Profile, 32-bit PCI 2.3 Slot 4: Low Profile, 32-bit PCI 2.3																																																														
Graphics	AMD 780V Chipset with HyperTransport™ 3.0 and PCI Express® 2.0 support; SB700 south bridge for SATA 3.0Gb/s with RAID 0/1 support, ATA-133 EIDE, PCI 2.3, USB, LPC bus / Winbond® W83627DHG Super I/O		Security <ul style="list-style-type: none"> • Security chip (see information on left) • One lock to secure both cover and entire system to fixed object: <ul style="list-style-type: none"> - Padlock loop (in rear for opt padlock) - Security slot (in rear for optional Kensington® Microsaver® cable) • Power-on password • Administrator password • Hard disk password • Boot sequence control • Boot without keyboard, mouse, diskette • Serial port I/O control • Parallel port I/O control • Individual USB port disablement 																																																														
SATA disk	160GB or 250GB , SATA 3.0Gb/s 7200 rpm, vibration dampening mounts		Supports ThinkVantage® technologies EPEAT™ Gold rating ENERGY STAR 4.0-compliant GREENGUARD® certified RoHS-compliant Limited Warranty¹ ⇨ 3-year parts and labor ⇨ International Warranty Service⁹ ⇨ Customer Replaceable Unit (CRU) parts only (with limited onsite service for selected parts³, 8 am - 5 pm, Mon - Fri coverage excluding holidays, next business day response time) ⇨ Onsite service upgrade options (in eligible locations):⁷ <ul style="list-style-type: none"> • 3-year LOR 9x5, 4 hour response (ThinkPlus™ part number 41C9192) • 3-year LOR 24x7, 4 hour response (ThinkPlus part number 41C9193) • 4-year LOR 9x5, Next Business Day (ThinkPlus part number 41C9194) • 4-year LOR 9x5, 4 hour response (ThinkPlus part number 41C9195) • 4-year LOR 24x7, 4 hour response (ThinkPlus part number 41C9196) ⇨ ThinkPlus services at lenovo.com/thinkplus/warranty ⇨ Post warranty maintenance services available ⇨ 24 hour x 7 day¹⁴ toll-free support during the warranty period¹ via 800-426-7378																																																														
SATA controller	Serial ATA, SATA 3.0Gb/s, integrated in SB700, RAID 0/1 support																																																																
SATA DVD	<i>Some:</i> DVD-ROM DL SATA 1.5Gb/s 16X-48X Max ⁴ Drive (41N5618)																																																																
SATA DVD±RW	<i>Some:</i> Super Multi-Burner DL DVD±RW SATA 1.5Gb/s Drive (41N5620)																																																																
SATA cables	Two SATA cables (each 1-drop to device), four SATA connectors on planar																																																																
eSATA port	None																																																																
EIDE controller	None																																																																
Diskette drive	None																																																																
Media reader	None																																																																
Chipset	AMD 780V Chipset with HyperTransport™ 3.0 and PCI Express® 2.0 support; SB700 south bridge for SATA 3.0Gb/s with RAID 0/1 support, ATA-133 EIDE, PCI 2.3, USB, LPC bus / Winbond® W83627DHG Super I/O																																																																
Front ports	Two USB 2.0, microphone (stereo, 3.5mm), headphone (stereo, 3.5mm)																																																																
Rear ports	Six USB 2.0, serial (9-pin), parallel (25-pin), keyboard (PS/2), mouse (PS/2), ethernet (RJ-45), monitor (VGA DB-15, DVI-D)																																																																
Internal connector	Two USB 2.0 planar conn (1 used; one open for media reader or 2 rear USB ports)																																																																
Rear audio ports	Line-in (stereo, 3.5mm), line-out (stereo, 3.5mm), microphone-in (stereo, 3.5mm)																																																																
Audio	High Definition (HD) Audio, Realtek® ALC662 codec																																																																
Speaker	One internal speaker for business audio																																																																
Ethernet	Gigabit ethernet on planar, Marvell® 88E8070, Wake on LAN®, ASF 2.0																																																																
Modem	None																																																																
Security chip	Winbond WPCT200 SafeKeeper™ Trusted Platform Module, TCG 1.2-compliant																																																																
Keyboard	Preferred Pro USB Keyboard (USB connector), 104-key, black, Lenovo logo																																																																
Mouse	Optical Wheel Mouse (USB connector), 400dpi, black, Lenovo logo																																																																
Power supply	220 watts with variable speed fan, autosensing, 80% PSU																																																																
Preloaded operating system²⁰	Accessories <table border="0"> <tr> <td>- <i>Some:</i> Microsoft® Windows® XP Professional with Vista® COA</td> <td>1GB PC2-5300 CL5 NP DDR2 UDIMM</td> <td>73P4984</td> </tr> <tr> <td>- <i>Some:</i> Microsoft Windows Vista Business Edition (32-bit)</td> <td>2GB PC2-5300 CL5 NP DDR2 UDIMM</td> <td>73P4985</td> </tr> <tr> <td>- <i>Some:</i> Microsoft Windows Vista Business Edition (64-bit)</td> <td>1GB PC2-6400 NP DDR2 UDIMM</td> <td>41U2977</td> </tr> <tr> <td>◇ <i>XP models:</i> Vista Basic logo</td> <td>2GB PC2-6400 NP DDR2 UDIMM</td> <td>41U2978</td> </tr> <tr> <td>◇ <i>Vista models:</i> Vista Premium logo</td> <td>250GB SATA 3.0Gb/s Disk (7200 rpm)</td> <td>41N3015</td> </tr> <tr> <td>Preloaded applications⁵ (all OSes; only some listed)</td> <td>500GB SATA 3.0Gb/s Disk (7200 rpm)</td> <td>43R1990</td> </tr> <tr> <td>• Rescue and Recovery™</td> <td>USB Portable Diskette Drive</td> <td>05K9276</td> </tr> <tr> <td>• Client Security Solution™</td> <td>USB 2.0 Lenovo Multimedia Headset</td> <td>40Y8518</td> </tr> <tr> <td>• ThinkVantage Productivity Center</td> <td>USB 2.0 Lenovo Webcam</td> <td>40Y8519</td> </tr> <tr> <td>• Microsoft Office 2007 Trial (60-day)</td> <td>USB 2.0 Essential Memory Key 32GB</td> <td>45K1258</td> </tr> <tr> <td>• Multimedia Center for Think Offerings (DVD, DVD±RW) (XP)</td> <td>USB 2.0 Ultra Secure Memory Key 8GB</td> <td>45J5918</td> </tr> <tr> <td>• Sonic RecordNow and Drive Letter Access (DVD±RW)</td> <td>USB 2.0 Portable Secure 320GB Hard Disk</td> <td>43R2019</td> </tr> <tr> <td>• Corel® WinDVD® (DVD, DVD±RW)</td> <td>ThinkVision® L2240p Wide 22" Monitor</td> <td>4422HB6</td> </tr> <tr> <td>• Corel WinDVD Creator (DVD±RW) (XP)</td> <td>ThinkVision L2440p Wide 24" Monitor</td> <td>4420HB2</td> </tr> <tr> <td></td> <td>Wireless Kbd & Opt Wheel Mouse (via USB)</td> <td>73P4067</td> </tr> <tr> <td></td> <td>Laser Tilt Wheel Mouse (USB, PS/2)</td> <td>41U3074</td> </tr> <tr> <td></td> <td>Kensington Cable Lock from Lenovo</td> <td>73P2582</td> </tr> <tr> <td></td> <td>ATI Radeon HD 2400 XT 256MB</td> <td>43R1962</td> </tr> <tr> <td></td> <td>ATI Radeon HD 3470 256MB (DP, VGA)</td> <td>45K1636</td> </tr> <tr> <td></td> <td>Acc Guide in pdf lenovo.com/accessoriesguide</td> <td></td> </tr> <tr> <td></td> <td>Other accessories at lenovo.com/accessories</td> <td></td> </tr> </table>		- <i>Some:</i> Microsoft® Windows® XP Professional with Vista® COA	1GB PC2-5300 CL5 NP DDR2 UDIMM	73P4984	- <i>Some:</i> Microsoft Windows Vista Business Edition (32-bit)	2GB PC2-5300 CL5 NP DDR2 UDIMM	73P4985	- <i>Some:</i> Microsoft Windows Vista Business Edition (64-bit)	1GB PC2-6400 NP DDR2 UDIMM	41U2977	◇ <i>XP models:</i> Vista Basic logo	2GB PC2-6400 NP DDR2 UDIMM	41U2978	◇ <i>Vista models:</i> Vista Premium logo	250GB SATA 3.0Gb/s Disk (7200 rpm)	41N3015	Preloaded applications⁵ (all OSes; only some listed)	500GB SATA 3.0Gb/s Disk (7200 rpm)	43R1990	• Rescue and Recovery™	USB Portable Diskette Drive	05K9276	• Client Security Solution™	USB 2.0 Lenovo Multimedia Headset	40Y8518	• ThinkVantage Productivity Center	USB 2.0 Lenovo Webcam	40Y8519	• Microsoft Office 2007 Trial (60-day)	USB 2.0 Essential Memory Key 32GB	45K1258	• Multimedia Center for Think Offerings (DVD, DVD±RW) (XP)	USB 2.0 Ultra Secure Memory Key 8GB	45J5918	• Sonic RecordNow and Drive Letter Access (DVD±RW)	USB 2.0 Portable Secure 320GB Hard Disk	43R2019	• Corel® WinDVD® (DVD, DVD±RW)	ThinkVision® L2240p Wide 22" Monitor	4422HB6	• Corel WinDVD Creator (DVD±RW) (XP)	ThinkVision L2440p Wide 24" Monitor	4420HB2		Wireless Kbd & Opt Wheel Mouse (via USB)	73P4067		Laser Tilt Wheel Mouse (USB, PS/2)	41U3074		Kensington Cable Lock from Lenovo	73P2582		ATI Radeon HD 2400 XT 256MB	43R1962		ATI Radeon HD 3470 256MB (DP, VGA)	45K1636		Acc Guide in pdf lenovo.com/accessoriesguide			Other accessories at lenovo.com/accessories	
- <i>Some:</i> Microsoft® Windows® XP Professional with Vista® COA	1GB PC2-5300 CL5 NP DDR2 UDIMM	73P4984																																																															
- <i>Some:</i> Microsoft Windows Vista Business Edition (32-bit)	2GB PC2-5300 CL5 NP DDR2 UDIMM	73P4985																																																															
- <i>Some:</i> Microsoft Windows Vista Business Edition (64-bit)	1GB PC2-6400 NP DDR2 UDIMM	41U2977																																																															
◇ <i>XP models:</i> Vista Basic logo	2GB PC2-6400 NP DDR2 UDIMM	41U2978																																																															
◇ <i>Vista models:</i> Vista Premium logo	250GB SATA 3.0Gb/s Disk (7200 rpm)	41N3015																																																															
Preloaded applications⁵ (all OSes; only some listed)	500GB SATA 3.0Gb/s Disk (7200 rpm)	43R1990																																																															
• Rescue and Recovery™	USB Portable Diskette Drive	05K9276																																																															
• Client Security Solution™	USB 2.0 Lenovo Multimedia Headset	40Y8518																																																															
• ThinkVantage Productivity Center	USB 2.0 Lenovo Webcam	40Y8519																																																															
• Microsoft Office 2007 Trial (60-day)	USB 2.0 Essential Memory Key 32GB	45K1258																																																															
• Multimedia Center for Think Offerings (DVD, DVD±RW) (XP)	USB 2.0 Ultra Secure Memory Key 8GB	45J5918																																																															
• Sonic RecordNow and Drive Letter Access (DVD±RW)	USB 2.0 Portable Secure 320GB Hard Disk	43R2019																																																															
• Corel® WinDVD® (DVD, DVD±RW)	ThinkVision® L2240p Wide 22" Monitor	4422HB6																																																															
• Corel WinDVD Creator (DVD±RW) (XP)	ThinkVision L2440p Wide 24" Monitor	4420HB2																																																															
	Wireless Kbd & Opt Wheel Mouse (via USB)	73P4067																																																															
	Laser Tilt Wheel Mouse (USB, PS/2)	41U3074																																																															
	Kensington Cable Lock from Lenovo	73P2582																																																															
	ATI Radeon HD 2400 XT 256MB	43R1962																																																															
	ATI Radeon HD 3470 256MB (DP, VGA)	45K1636																																																															
	Acc Guide in pdf lenovo.com/accessoriesguide																																																																
	Other accessories at lenovo.com/accessories																																																																

See footnotes for important warranty information

ES US models announced December 9, 2008; previous models on August 12 or September 9, 2008

© Lenovo (ATHN1-2) December 2008

Name	Type-model	Slot x bay	AMD processor	GHz	Core	Memory ⁶	SATA disk	SATA optical	Integrated graphics	Monitor connectors	Vista preload	Global (G) GMP (P)	Avail date
A62	7062-A1U	4x3	Athlon X2 5400B	2.8	Dual	2GB	160GB ²	DVD±RW	3100	VGA, DVI-D	Business32	G P	Sep 08

- This model is part of the Global Models Plus (GMP) program with limited onsite service³ 3-year limited warranty

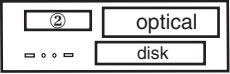
Positioning Processor	Stability and manageability for large enterprise and mid-market AMD® Athlon™ X2 Dual-Core Processor 5400B with dual-core, virtualization technology, integrated DDR2 memory controller, and 1MB dedicated L2 cache		Desktop	
Implementation	Processor in Socket AM2		<ul style="list-style-type: none"> • Business black color • 13.0" W X 16.2" D X 4.1" H • 331mm W X 412mm D X 104mm H • 19.4lb (8.8kg) in typical configuration • Toolless cover removal • Toolless disk, diskette drive, optical drive removal • Toolless adapter retention 	
Memory	2GB std , 8GB max ⁶ , PC2-6400 800MHz DDR2 , non-parity, dual-channel capable, four 240-pin DIMM sockets; <i>Italics:</i> standard memory in two sockets; two sockets available		<ul style="list-style-type: none"> • 19.4lb (8.8kg) in typical configuration • Toolless cover removal • Toolless disk, diskette drive, optical drive removal • Toolless adapter retention 	
Graphics	ATI™ Radeon™ 3100 , integrated graphics in 780V, uses main memory (up to 512MB), one analog VGA DB-15 connector, one DVI-D connector, DirectX® 10, ATI Avivo™, SurroundView™, supports dual independent display; supports up to 4 independent monitors with optional dual-head ATI graphics adapter		<ul style="list-style-type: none"> • 19.4lb (8.8kg) in typical configuration • Toolless cover removal • Toolless disk, diskette drive, optical drive removal • Toolless adapter retention 	
SATA disk	160GB , SATA 3.0Gb/s 7200 rpm, vibration dampening mounts		<ul style="list-style-type: none"> • 19.4lb (8.8kg) in typical configuration • Toolless cover removal • Toolless disk, diskette drive, optical drive removal • Toolless adapter retention 	
SATA controller	Serial ATA, SATA 3.0Gb/s, integrated in SB700, RAID 0/1 support		<ul style="list-style-type: none"> • 19.4lb (8.8kg) in typical configuration • Toolless cover removal • Toolless disk, diskette drive, optical drive removal • Toolless adapter retention 	
SATA DVD±RW	Super Multi-Burner DL DVD±RW SATA 1.5Gb/s Drive (41N5620)		<ul style="list-style-type: none"> • 19.4lb (8.8kg) in typical configuration • Toolless cover removal • Toolless disk, diskette drive, optical drive removal • Toolless adapter retention 	
SATA cables	Two SATA cables (each 1-drop to device), four SATA connectors		<ul style="list-style-type: none"> • 19.4lb (8.8kg) in typical configuration • Toolless cover removal • Toolless disk, diskette drive, optical drive removal • Toolless adapter retention 	
eSATA port	None		<ul style="list-style-type: none"> • 19.4lb (8.8kg) in typical configuration • Toolless cover removal • Toolless disk, diskette drive, optical drive removal • Toolless adapter retention 	
EIDE controller	None		<ul style="list-style-type: none"> • 19.4lb (8.8kg) in typical configuration • Toolless cover removal • Toolless disk, diskette drive, optical drive removal • Toolless adapter retention 	
Diskette drive	None		<ul style="list-style-type: none"> • 19.4lb (8.8kg) in typical configuration • Toolless cover removal • Toolless disk, diskette drive, optical drive removal • Toolless adapter retention 	
Media reader	None		<ul style="list-style-type: none"> • 19.4lb (8.8kg) in typical configuration • Toolless cover removal • Toolless disk, diskette drive, optical drive removal • Toolless adapter retention 	
Chipset	AMD 780V Chipset with HyperTransport™ 3.0 and PCI Express® 2.0 support; SB700 south bridge for SATA 3.0Gb/s with RAID 0/1 support, ATA-133 EIDE, PCI 2.3, USB, LPC bus / Winbond® W83627DHG Super I/O		<ul style="list-style-type: none"> • 19.4lb (8.8kg) in typical configuration • Toolless cover removal • Toolless disk, diskette drive, optical drive removal • Toolless adapter retention 	
Front ports	Two USB 2.0, microphone (stereo, 3.5mm), headphone (stereo, 3.5mm)		<ul style="list-style-type: none"> • 19.4lb (8.8kg) in typical configuration • Toolless cover removal • Toolless disk, diskette drive, optical drive removal • Toolless adapter retention 	
Rear ports	Six USB 2.0, serial (9-pin), parallel (25-pin), keyboard (PS/2), mouse (PS/2), ethernet (RJ-45), monitor (VGA DB-15, DVI-D)		<ul style="list-style-type: none"> • 19.4lb (8.8kg) in typical configuration • Toolless cover removal • Toolless disk, diskette drive, optical drive removal • Toolless adapter retention 	
Internal connector	Two USB 2.0 planar conn (1 used; one open for media reader or 2 rear USB ports)		<ul style="list-style-type: none"> • 19.4lb (8.8kg) in typical configuration • Toolless cover removal • Toolless disk, diskette drive, optical drive removal • Toolless adapter retention 	
Rear audio ports	Line-in (stereo, 3.5mm), line-out (stereo, 3.5mm), microphone-in (stereo, 3.5mm)		<ul style="list-style-type: none"> • 19.4lb (8.8kg) in typical configuration • Toolless cover removal • Toolless disk, diskette drive, optical drive removal • Toolless adapter retention 	
Audio	High Definition (HD) Audio, Realtek® ALC662 codec		<ul style="list-style-type: none"> • 19.4lb (8.8kg) in typical configuration • Toolless cover removal • Toolless disk, diskette drive, optical drive removal • Toolless adapter retention 	
Speaker	One internal speaker for business audio		<ul style="list-style-type: none"> • 19.4lb (8.8kg) in typical configuration • Toolless cover removal • Toolless disk, diskette drive, optical drive removal • Toolless adapter retention 	
Ethernet	Gigabit ethernet on planar, Marvel® 88E8070, Wake on LAN®, ASF 2.0		<ul style="list-style-type: none"> • 19.4lb (8.8kg) in typical configuration • Toolless cover removal • Toolless disk, diskette drive, optical drive removal • Toolless adapter retention 	
Modem	None		<ul style="list-style-type: none"> • 19.4lb (8.8kg) in typical configuration • Toolless cover removal • Toolless disk, diskette drive, optical drive removal • Toolless adapter retention 	
Security chip	Winbond WPCT200 SafeKeeper™ Trusted Platform Module, TCG 1.2-compliant		<ul style="list-style-type: none"> • 19.4lb (8.8kg) in typical configuration • Toolless cover removal • Toolless disk, diskette drive, optical drive removal • Toolless adapter retention 	
Keyboard	Preferred Pro USB Keyboard (USB connector), 104-key, black, Lenovo logo		<ul style="list-style-type: none"> • 19.4lb (8.8kg) in typical configuration • Toolless cover removal • Toolless disk, diskette drive, optical drive removal • Toolless adapter retention 	
Mouse	Optical Wheel Mouse (USB connector), 400dpi, black, Lenovo logo		<ul style="list-style-type: none"> • 19.4lb (8.8kg) in typical configuration • Toolless cover removal • Toolless disk, diskette drive, optical drive removal • Toolless adapter retention 	
Power supply	220 watts with variable speed fan, manual switch		<ul style="list-style-type: none"> • 19.4lb (8.8kg) in typical configuration • Toolless cover removal • Toolless disk, diskette drive, optical drive removal • Toolless adapter retention 	
Preloaded operating system²⁰	Accessories			
- Microsoft® Windows® Vista® Business Edition (32-bit)	1GB PC2-6400 NP DDR2 UDIMM	41U2977		Supports ThinkVantage® technologies
◇ Vista Premium logo	2GB PC2-6400 NP DDR2 UDIMM	41U2978		GREENGUARD® certified
Preloaded applications⁵	250GB SATA 3.0Gb/s Disk (7200 rpm)	41N3015		RoHS-compliant
• Rescue and Recovery™	500GB SATA 3.0Gb/s Disk (7200 rpm)	43R1990		
• Client Security Solution™	USB Portable Diskette Drive	05K9276		
• ThinkVantage Productivity Center	USB 2.0 Lenovo Multimedia Headset	40Y8518		
• ThinkVantage System Update	USB 2.0 Lenovo Webcam	40Y8519		
• Norton Internet Security™ (90 days of virus definitions)	USB 2.0 Essential Memory Key 32GB	45K1258		
• Diskeeper® Home	USB 2.0 Security Memory Key 2GB	41U5119		
• PC-Doctor™ (diagnostics)	USB 2.0 Security Memory Key 4GB	41U5120		
• Adobe® Reader	USB 2.0 Ultra Secure Memory Key 2GB	45J5916		
• Windows Live™ Toolbar	USB 2.0 Ultra Secure Memory Key 4GB	45J5917		
• Windows Live Search	USB 2.0 Ultra Secure Memory Key 8GB	45J5918		
• Picasa from Google	USB 2.0 Portable 160GB Hard Disk	43R1784		
• Microsoft Office 2007 Trial (60-day)	USB 2.0 Portable Secure 320GB Hard Disk	43R2019		
• Sonic RecordNow and Drive Letter Access (DVD±RW)	ThinkVision® L1700p 17" Monitor	9417HE2		
• Corel® WinDVD® (DVD±RW)	ThinkVision L1940p Wide 19" Monitor	4424HB6		
	ThinkVision L2240p Wide 22" Monitor	4422HB6		
	ThinkVision L2440p Wide 24" Monitor	4420HB2		
	Wireless Kbd & Opt Wheel Mouse (via USB)	73P4067		
	Laser Tilt Wheel Mouse (USB, PS/2)	41U3074		
	Kensington Cable Lock from Lenovo	73P2582		
	ATI Radeon HD 2400 XT 256MB	43R1962		
	ATI Radeon HD 3470 256MB (DP, VGA)	45K1636		
	Acc Guide in pdf lenovo.com/accessoriesguide			
	Other accessories at lenovo.com/accessories			
				Limited Warranty¹
				↔ 3-year parts and labor
				↔ International Warranty Service⁹
				↔ Customer Replaceable Unit (CRU) parts only (with limited onsite service for selected parts³, 8 am - 5 pm, Mon - Fri coverage excluding holidays, next business day response time)
				↔ Onsite service upgrade options (in eligible locations):⁷
				• 4-year LOR 9x5, Next Business Day (ThinkPlus part number 41C9194)
				• 4-year LOR 9x5, 4 hour response (ThinkPlus part number 41C9195)
				• 4-year LOR 24x7, 4 hour response (ThinkPlus part number 41C9196)
				↔ ThinkPlus services at lenovo.com/thinkplus/warranty
				↔ Post warranty maintenance services available
				↔ 24 hour x 7 day¹⁴ toll-free support during the warranty period¹ via 800-426-7378

See footnotes for important warranty information
US model announced August 12, 2008

ThinkCentre® A62 Desktop (3658) - ENERGY STAR® 4.0 (GMP)

Personal Systems Reference (PSREF)

Name	Type-model	Slot x bay	AMD processor	GHz	Core	Memory ⁸	SATA disk	SATA optical	Integrated graphics	Monitor connectors	ENERGY STAR 4.0	Vista preload	Global (G) GMP (P)	Avail date
A62	3658-AAU	4x3	Athlon X2 5400B	2.8	Dual	2GB	160GB ²	DVD±RW	3100	VGA, DVI-D	ES40	Bus32	G P	Jan 09

- This model is part of the Global Models Plus (GMP) program with limited onsite service³ 3-year limited warranty

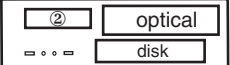
Positioning Processor	Stability and manageability for large enterprise and mid-market AMD® Athlon™ X2 Dual-Core Processor 5400B with dual-core, virtualization technology, integrated DDR2 memory controller, and 1MB dedicated L2 cache		Desktop  <ul style="list-style-type: none"> • Business black color • 13.0" W X 16.2" D X 4.1" H • 331mm W X 412mm D X 104mm H • 19.4lb (8.8kg) in typical configuration • Toolless cover removal • Toolless disk, diskette drive, optical drive removal • Toolless adapter retention
Implementation	Processor in Socket AM2		
Memory	2GB std, 8GB max ⁸ , PC2-6400 800MHz DDR2, non-parity, dual-channel capable, four 240-pin DIMM sockets; <i>Italics:</i> standard memory in two sockets; two sockets available		<ul style="list-style-type: none"> Bay ① 5.25", 1.6" high, access, std optical Bay ② 3.5", 1" high, access, open* Bay ③ 3.5", 1" high, no access, std disk
Graphics	ATI™ Radeon™ 3100, integrated graphics in 780V, uses main memory (up to 512MB), one analog VGA DB-15 connector, one DVI-D connector, DirectX® 10, ATI Avivo™, SurroundView™, supports dual independent display; supports up to 4 independent monitors with optional dual-head ATI graphics adapter		<ul style="list-style-type: none"> * supports reader/diskette/2nd disk
SATA disk	160GB, SATA 3.0Gb/s 7200 rpm, vibration dampening mounts		<ul style="list-style-type: none"> Slot 1: Low Profile, PCI Express 2.0 x1 Slot 2: Low Profile, PCI Express 2.0 x16 (35w max) Slot 3: Low Profile, 32-bit PCI 2.3 Slot 4: Low Profile, 32-bit PCI 2.3
SATA controller	Serial ATA, SATA 3.0Gb/s, integrated in SB700, RAID 0/1 support		
SATA DVD±RW	Super Multi-Burner DL DVD±RW SATA 1.5Gb/s Drive (41N5620)		
SATA cables	Two SATA cables (each 1-drop to device), four SATA connectors		
eSATA port	None		Security <ul style="list-style-type: none"> • Security chip (see information on left) • One lock to secure both cover and entire system to fixed object: <ul style="list-style-type: none"> - Padlock loop (in rear for opt padlock) - Security slot (in rear for optional Kensington® Microsaver® cable) • Power-on password • Administrator password • Hard disk password • Boot sequence control • Boot without keyboard, mouse, diskette • Serial port I/O control • Parallel port I/O control • Individual USB port disablement
EIDE controller	None		
Diskette drive	None		
Media reader	None		
Chipset	AMD 780V Chipset with HyperTransport™ 3.0 and PCI Express® 2.0 support; SB700 south bridge for SATA 3.0Gb/s with RAID 0/1 support, ATA-133 EIDE, PCI 2.3, USB, LPC bus / Winbond® W83627DHG Super I/O		
Front ports	Two USB 2.0, microphone (stereo, 3.5mm), headphone (stereo, 3.5mm)		
Rear ports	Six USB 2.0, serial (9-pin), parallel (25-pin), keyboard (PS/2), mouse (PS/2), ethernet (RJ-45), monitor (VGA DB-15, DVI-D)		
Internal connector	Two USB 2.0 planar conn (1 used; one open for media reader or 2 rear USB ports)		
Rear audio ports	Line-in (stereo, 3.5mm), line-out (stereo, 3.5mm), microphone-in (stereo, 3.5mm)		
Audio	High Definition (HD) Audio, Realtek® ALC662 codec		
Speaker	One internal speaker for business audio		
Ethernet	Gigabit ethernet on planar, Marvell® 88E8070, Wake on LAN®, ASF 2.0		
Modem	None		
Security chip	Winbond WPCT200 SafeKeeper™ Trusted Platform Module, TCG 1.2-compliant		
Keyboard	Preferred Pro USB Keyboard (USB connector), 104-key, black, Lenovo logo		
Mouse	Optical Wheel Mouse (USB connector), 400dpi, black, Lenovo logo		
Power supply	220 watts with variable speed fan, autosensing, 80% PSU		
Preloaded operating system²⁰	Accessories		Supports ThinkVantage® technologies EPEAT™ Gold rating ENERGY STAR 4.0-compliant GREENGUARD® certified RoHS-compliant Limited Warranty¹ <ul style="list-style-type: none"> ↔ 3-year parts and labor ↔ International Warranty Service⁹ ↔ Customer Replaceable Unit (CRU) parts only (with limited onsite service for selected parts³, 8 am - 5 pm, Mon - Fri coverage excluding holidays, next business day response time) ↔ Onsite service upgrade options (in eligible locations):⁷ <ul style="list-style-type: none"> • 4-year LOR 9x5, Next Business Day (ThinkPlus part number 41C9194) • 4-year LOR 9x5, 4 hour response (ThinkPlus part number 41C9195) • 4-year LOR 24x7, 4 hour response (ThinkPlus part number 41C9196) ↔ ThinkPlus services at lenovo.com/thinkplus/warranty ↔ Post warranty maintenance services available ↔ 24 hour x 7 day¹⁴ toll-free support during the warranty period¹ via 800-426-7378
- Microsoft® Windows® Vista® Business Edition (32-bit) ↔ Vista Premium logo	1GB PC2-6400 NP DDR2 UDIMM 41U2977 2GB PC2-6400 NP DDR2 UDIMM 41U2978 250GB SATA 3.0Gb/s Disk (7200 rpm) 41N3015 500GB SATA 3.0Gb/s Disk (7200 rpm) 43R1990 USB Portable Diskette Drive 05K9276 USB 2.0 Lenovo Multimedia Headset 40Y8518 USB 2.0 Lenovo Webcam 40Y8519 USB 2.0 Essential Memory Key 32GB 45K1258 USB 2.0 Security Memory Key 2GB 41U5119 USB 2.0 Security Memory Key 4GB 41U5120 USB 2.0 Ultra Secure Memory Key 2GB 45J5916 USB 2.0 Ultra Secure Memory Key 4GB 45J5917 USB 2.0 Ultra Secure Memory Key 8GB 45J5918 USB 2.0 Portable 160GB Hard Disk 43R1784 USB 2.0 Portable Secure 320GB Hard Disk 43R2019 ThinkVision® L1700p 17" Monitor 9417HE2 ThinkVision L1940p Wide 19" Monitor 4424HB6 ThinkVision L2240p Wide 22" Monitor 4422HB6 ThinkVision L2440p Wide 24" Monitor 4420HB2 Wireless Kbd & Opt Wheel Mouse (via USB) 73P4067 Laser Tilt Wheel Mouse (USB, PS/2) 41U3074 Kensington Cable Lock from Lenovo 73P2582 ATI Radeon HD 2400 XT 256MB 43R1962 ATI Radeon HD 3470 256MB (DP, VGA) 45K1636 Acc Guide in pdf lenovo.com/accessoriesguide Other accessories at lenovo.com/accessories		

See footnotes for important warranty information
US model announced December 9, 2008

ThinkCentre® A62 Tower (9705) - TopSeller

Personal Systems Reference (PSREF)

Name	Type-model	Slot x bay	AMD processor	GHz	Core	Memory ^a	SATA disk	2nd Disk Bay	SATA optical	Integrated graphics	Monitor connectors	Vista preload	Global Educ	Avail date
A62	9705-B5U	4x4	Athlon 1640B	2.7	Single	1GB	160GB ^b	None	DVD±RW	3100	VGA, DVI-D	Home Basic	None	Dec 08
A62	9705-B6U	4x4	Athlon X2 4450B	2.3	Dual	2GB	160GB	None	DVD±RW	3100	VGA, DVI-D	Home Basic	None	Dec 08
A62	9705-B7U	4x4	Athlon X2 5000B	2.6	Dual	2GB	320GB	None	DVD±RW	3100	VGA, DVI-D	Home Premium	None	Dec 08

- These small and medium business (SMB) models are part of the US TopSeller™ Program
- These models have a 1-year limited warranty¹

Positioning Processor	Quality, reliability, and manageability for small/medium businesses										Tower																																															
Implementation	AMD® Athlon™ Processor 1640B with single-core, virtualization technology, int DDR2 memory controller, and 512KB L2 cache or AMD Athlon X2 Dual-Core Processor 4450B or 5000B with dual-core, virtualization technology, integrated DDR2 memory controller, and 1MB dedicated L2 cache										<ul style="list-style-type: none"> • Business black color • 6.9" W X 17.3" D X 15.8" H • 175mm W X 440mm D X 402mm H • 24.2lb (11.0kg) in typical configuration • Handle on top front • Toolless cover removal • Toolless disk, diskette drive, optical drive removal • Toolless adapter retention 																																															
Memory	1GB or 2GB std, 8GB max ⁸ , PC2-6400 800MHz DDR2, non-parity, dual-channel capable, four 240-pin DIMM sockets; <i>Italics:</i> standard memory in two sockets; two sockets available; <i>Non-italics:</i> standard memory in one socket; three sockets available										Bay ① 5.25", 1.6" high, access, std optical Bay ② 5.25", 1.6" high, access, open Bay ③ 3.5", 1" high, access, open (reader/diskette) Bay ④ 3.5", 1" high, no access, std disk																																															
Graphics	ATI™ Radeon™ 3100, integrated graphics in 780V, uses main memory (up to 512MB), one analog VGA DB-15 connector, one DVI-D connector, DirectX® 10, ATI Avivo™, SurroundView™, supports dual independent display; supports up to 4 independent monitors with optional dual-head ATI graphics adapter										Slot 1: half-length, full-height, PCIe 2.0 x1 Slot 2: half-length, full-height, PCIe 2.0 x16 (75w max) Slot 3: half-length, full-height, 32-bit PCI 2.3 Slot 4: half-length, full-height, 32-bit PCI 2.3																																															
SATA disk	160GB or 320GB, SATA 3.0Gb/s 7200 rpm, vibration dampening										Security <ul style="list-style-type: none"> • Security chip (see information on left) • One lock to secure both cover and entire system to fixed object: <ul style="list-style-type: none"> - Padlock loop (in rear for opt padlock) - Security slot (in rear for optional Kensington® Microsaver® cable) • Power-on password • Administrator password • Hard disk password • Boot sequence control • Boot without keyboard, mouse, diskette • Serial port I/O control • Parallel port I/O control • Individual USB port disablement 																																															
SATA controller	Serial ATA, SATA 3.0Gb/s, integrated in SB700, RAID 0/1 support																																																									
SATA DVD±RW	Super Multi-Burner DL DVD±RW SATA 1.5Gb/s Drive (41N5620)																																																									
SATA cables	Two SATA cables (each 1-drop to device), four SATA connectors on planar																																																									
eSATA port	None										Supports ThinkVantage® technologies																																															
EIDE controller	None																																																									
Diskette drive	None																																																									
Media reader	None																																																									
Chipset	AMD 780V Chipset with HyperTransport™ 3.0 and PCI Express® 2.0 support; SB700 south bridge for SATA 3.0Gb/s with RAID 0/1 support, ATA-133 EIDE, PCI 2.3, USB, LPC bus / Winbond® W83627DHG Super I/O										GREENGUARD® certified RoHS-compliant																																															
Front ports	Two USB 2.0, microphone (stereo, 3.5mm), headphone (stereo, 3.5mm)																																																									
Rear ports	Six USB 2.0, serial (9-pin), parallel (25-pin), keyboard (PS/2), mouse (PS/2), ethernet (RJ-45), monitor (VGA DB-15, DVI-D)																																																									
Internal connector	Two USB 2.0 planar conn (1 used; one open for media reader or 2 rear USB ports)																																																									
Rear audio ports	Line-in (stereo, 3.5mm), line-out (stereo, 3.5mm), microphone-in (stereo, 3.5mm)										Limited Warranty¹ <ul style="list-style-type: none"> ↔ 1-year parts and labor ↔ International Warranty Service⁹ ↔ Customer Replaceable Unit (CRU) parts only (with limited onsite service for selected parts³, 8 am - 5 pm, Mon - Fri coverage excluding holidays, next business day response time) ↔ Onsite service upgrade options (in eligible locations):⁷ <ul style="list-style-type: none"> • 1-year LOR 9x5, 4 hour response (ThinkPlus™ part number 41C9189) • 2-year LOR 9x5, Next Business Day (ThinkPlus part number 41C9187) • 2-year LOR 9x5, 4 hour response (ThinkPlus part number 41C9190) • 3-year LOR 9x5, Next Business Day (ThinkPlus part number 41C9188) • 3-year LOR 9x5, 4 hour response (ThinkPlus part number 41C9191) ↔ ThinkPlus services at lenovo.com/thinkplus/warranty ↔ Post warranty maintenance services available ↔ 24 hour x 7 day¹⁴ toll-free support during the warranty period¹ via 800-426-7378 																																															
Audio	High Definition (HD) Audio, Realtek® ALC662 codec																																																									
Speaker	One internal speaker for business audio																																																									
Ethernet	Gigabit ethernet on planar, Marvel® 88E8070, Wake on LAN®, ASF 2.0																																																									
Modem	None										Preloaded operating system²⁰ <ul style="list-style-type: none"> - <i>Some:</i> Microsoft® Windows® Vista® Home Basic Edition (32-bit) - <i>Some:</i> Microsoft Windows Vista Home Premium Edition (32-bit) ✦ Vista Basic logo																																															
Security chip	Winbond WPCT200 SafeKeeper™ Trusted Platform Module, TCG 1.2-compliant																																																									
Keyboard	Preferred Pro USB Keyboard (USB connector), 104-key, black, Lenovo logo																																																									
Mouse	Optical Wheel Mouse (USB connector), 400dpi, black, Lenovo logo																																																									
Power supply	280 watts with variable speed fan, manual switch										Accessories <table border="0"> <tr><td>1GB PC2-6400 NP DDR2 UDIMM</td><td>41U2977</td></tr> <tr><td>2GB PC2-6400 NP DDR2 UDIMM</td><td>41U2978</td></tr> <tr><td>250GB SATA 3.0Gb/s Disk (7200 rpm)</td><td>41N3015</td></tr> <tr><td>500GB SATA 3.0Gb/s Disk (7200 rpm)</td><td>43R1990</td></tr> <tr><td>USB Portable Diskette Drive</td><td>05K9276</td></tr> <tr><td>USB 2.0 Lenovo Multimedia Headset</td><td>40Y8518</td></tr> <tr><td>USB 2.0 Lenovo Webcam</td><td>40Y8519</td></tr> <tr><td>USB 2.0 Essential Memory Key 32GB</td><td>45K1258</td></tr> <tr><td>USB 2.0 Ultra Secure Memory Key 2GB</td><td>45J5916</td></tr> <tr><td>USB 2.0 Ultra Secure Memory Key 4GB</td><td>45J5917</td></tr> <tr><td>USB 2.0 Ultra Secure Memory Key 8GB</td><td>45J5918</td></tr> <tr><td>USB 2.0 Portable 160GB Hard Disk</td><td>43R1784</td></tr> <tr><td>USB 2.0 Portable Secure 320GB Hard Disk</td><td>43R2019</td></tr> <tr><td>ThinkVision® L1700p 17" Monitor</td><td>9417HE2</td></tr> <tr><td>ThinkVision L1940p Wide 19" Monitor</td><td>4424HB6</td></tr> <tr><td>ThinkVision L2240p Wide 22" Monitor</td><td>4422HB6</td></tr> <tr><td>ThinkVision L2440p Wide 24" Monitor</td><td>4420HB2</td></tr> <tr><td>Wireless Kbd & Opt Wheel Mouse (via USB)</td><td>73P4067</td></tr> <tr><td>Laser Tilt Wheel Mouse (USB, PS/2)</td><td>41U3074</td></tr> <tr><td>Kensington Cable Lock from Lenovo</td><td>73P2582</td></tr> <tr><td>ATI Radeon HD 2400 XT 256MB</td><td>43R1962</td></tr> <tr><td>ATI Radeon HD 3470 256MB (DP, VGA)</td><td>45K1636</td></tr> <tr><td>NVIDIA® GeForce® 9500GT 512MB (DP, DVI)</td><td>45K1635</td></tr> </table> Acc Guide in pdf lenovo.com/accessoriesguide Other accessories at lenovo.com/accessories		1GB PC2-6400 NP DDR2 UDIMM	41U2977	2GB PC2-6400 NP DDR2 UDIMM	41U2978	250GB SATA 3.0Gb/s Disk (7200 rpm)	41N3015	500GB SATA 3.0Gb/s Disk (7200 rpm)	43R1990	USB Portable Diskette Drive	05K9276	USB 2.0 Lenovo Multimedia Headset	40Y8518	USB 2.0 Lenovo Webcam	40Y8519	USB 2.0 Essential Memory Key 32GB	45K1258	USB 2.0 Ultra Secure Memory Key 2GB	45J5916	USB 2.0 Ultra Secure Memory Key 4GB	45J5917	USB 2.0 Ultra Secure Memory Key 8GB	45J5918	USB 2.0 Portable 160GB Hard Disk	43R1784	USB 2.0 Portable Secure 320GB Hard Disk	43R2019	ThinkVision® L1700p 17" Monitor	9417HE2	ThinkVision L1940p Wide 19" Monitor	4424HB6	ThinkVision L2240p Wide 22" Monitor	4422HB6	ThinkVision L2440p Wide 24" Monitor	4420HB2	Wireless Kbd & Opt Wheel Mouse (via USB)	73P4067	Laser Tilt Wheel Mouse (USB, PS/2)	41U3074	Kensington Cable Lock from Lenovo	73P2582	ATI Radeon HD 2400 XT 256MB	43R1962	ATI Radeon HD 3470 256MB (DP, VGA)	45K1636	NVIDIA® GeForce® 9500GT 512MB (DP, DVI)	45K1635
1GB PC2-6400 NP DDR2 UDIMM	41U2977																																																									
2GB PC2-6400 NP DDR2 UDIMM	41U2978																																																									
250GB SATA 3.0Gb/s Disk (7200 rpm)	41N3015																																																									
500GB SATA 3.0Gb/s Disk (7200 rpm)	43R1990																																																									
USB Portable Diskette Drive	05K9276																																																									
USB 2.0 Lenovo Multimedia Headset	40Y8518																																																									
USB 2.0 Lenovo Webcam	40Y8519																																																									
USB 2.0 Essential Memory Key 32GB	45K1258																																																									
USB 2.0 Ultra Secure Memory Key 2GB	45J5916																																																									
USB 2.0 Ultra Secure Memory Key 4GB	45J5917																																																									
USB 2.0 Ultra Secure Memory Key 8GB	45J5918																																																									
USB 2.0 Portable 160GB Hard Disk	43R1784																																																									
USB 2.0 Portable Secure 320GB Hard Disk	43R2019																																																									
ThinkVision® L1700p 17" Monitor	9417HE2																																																									
ThinkVision L1940p Wide 19" Monitor	4424HB6																																																									
ThinkVision L2240p Wide 22" Monitor	4422HB6																																																									
ThinkVision L2440p Wide 24" Monitor	4420HB2																																																									
Wireless Kbd & Opt Wheel Mouse (via USB)	73P4067																																																									
Laser Tilt Wheel Mouse (USB, PS/2)	41U3074																																																									
Kensington Cable Lock from Lenovo	73P2582																																																									
ATI Radeon HD 2400 XT 256MB	43R1962																																																									
ATI Radeon HD 3470 256MB (DP, VGA)	45K1636																																																									
NVIDIA® GeForce® 9500GT 512MB (DP, DVI)	45K1635																																																									

See footnotes for important warranty information
US models announced November 25, 2008

ThinkCentre® A62 Tower (9705) - TopSeller (December 2008)

Personal Systems Reference (PSREF)

Name	Type-model	Slot x bay	AMD processor	GHz Core	Memory ⁸	SATA disk	SATA optical	Graphics	Monitor connectors	Vista preload	Global Educ	Avail date
A62	9705-B8U	4x4	Phenom X3 8450	2.1 Triple	3 x 1GB	320GB ²	DVD±RW	3100, 3470	VGA, DVI-D, VGA, DP	Home Prem	No	Jan 09

- **This small and medium business (SMB) model is part of the US TopSeller™ Program**
- **This model has a 1-year limited warranty¹**

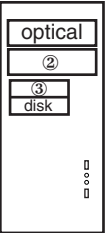
Positioning Processor	Quality, reliability, and manageability for small/medium businesses		AMD® Phenom™ X3 Triple-Core Processor 8450 with triple-core, virtualization technology, integrated DDR2 memory controller, 1.5MB dedicated L2 cache and 2MB shared L3 cache Processor in Socket AM2+		Tower			
Implementation	3GB std, 8GB max⁸, PC2-6400 800MHz DDR2 , non-parity, dual-channel capable, four 240-pin DIMM sockets; <i>Italics:</i> standard memory in three sockets; one socket available		ATI™ Radeon™ 3100 , integrated graphics in 780V, uses main memory (up to 512MB), one analog VGA DB-15 connector, one DVI-D connector, DirectX® 10, ATI Avivo™, SurroundView™, supports dual independent display; supports up to 4 independent monitors with standard dual-head ATI graphics adapter ATI Radeon HD 3470 , PCI Express® 2.0 x16 adapter, 256MB, one analog VGA DB-15 connector, one DisplayPort™ connector, HDCP, DirectX 10.1, ATI Avivo, SurroundView, 25 watts		<ul style="list-style-type: none"> • Business black color • 6.9" W X 17.3" D X 15.8" H • 175mm W X 440mm D X 402mm H • 24.2lb (11.0kg) in typical configuration • Handle on top front • Toolless cover removal • Toolless disk, diskette drive, optical drive removal • Toolless adapter retention 		Bay ① 5.25", 1.6" high, access, std optical Bay ② 5.25", 1.6" high, access, open Bay ③ 3.5", 1" high, access, open (reader/diskette) Bay ④ 3.5", 1" high, no access, std disk	
Memory	320GB , SATA 3.0Gb/s 7200 rpm, vibration dampening mounts SATA controller Serial ATA, SATA 3.0Gb/s, integrated in SB700, RAID 0/1 support SATA DVD±RW Super Multi-Burner DL DVD±RW SATA 1.5Gb/s Drive (41N5620) SATA cables Two SATA cables (each 1-drop to device), four SATA connectors eSATA port None EIDE controller None Diskette drive None Media reader None		Slot 1: half-length, full-height, PCIe 2.0 x1 Slot 2: half-length, full-height, PCIe 2.0 x16 (75w max)* Slot 3: half-length, full-height, 32-bit PCI 2.3 Slot 4: half-length, full-height, 32-bit PCI 2.3 * graphics adapter in slot		Security <ul style="list-style-type: none"> • Security chip (see information on left) • One lock to secure both cover and entire system to fixed object: <ul style="list-style-type: none"> - Padlock loop (in rear for opt padlock) - Security slot (in rear for optional Kensington® Microsaver® cable) • Power-on password • Administrator password • Hard disk password • Boot sequence control • Boot without keyboard, mouse, diskette • Serial port I/O control • Parallel port I/O control • Individual USB port disablement 		Supports ThinkVantage® technologies	
Chipset	AMD 780V Chipset with HyperTransport™ 3.0 and PCI Express 2.0 support; SB700 south bridge for SATA 3.0Gb/s with RAID 0/1 support, ATA-133 EIDE, PCI 2.3, USB, LPC bus / Winbond® W83627DHG Super I/O		Front ports Two USB 2.0, microphone (stereo, 3.5mm), headphone (stereo, 3.5mm) Rear ports Six USB 2.0, serial (9-pin), parallel (25-pin), keyboard (PS/2), mouse (PS/2), ethernet (RJ-45), monitor (VGA DB-15, DVI-D, VGA DB-15, DP) Internal connector Two USB 2.0 planar conn (1 used; one open for media reader or 2 rear USB ports) Rear audio ports Line-in (stereo, 3.5mm), line-out (stereo, 3.5mm), microphone-in (stereo, 3.5mm) Audio High Definition (HD) Audio, Realtek® ALC662 codec Speaker One internal speaker for business audio Ethernet Gigabit ethernet on planar, Marvel® 88E8070, Wake on LAN®, ASF 2.0 Modem None Security chip Winbond WPCT200 SafeKeeper™ Trusted Platform Module, TCG 1.2-compliant		GREENGUARD® certified RoHS-compliant		Limited Warranty¹ <ul style="list-style-type: none"> ↔ 1-year parts and labor ↔ International Warranty Service⁹ ↔ Customer Replaceable Unit (CRU) parts only (with limited onsite service for selected parts³, 8 am - 5 pm, Mon - Fri coverage excluding holidays, next business day response time) ↔ Onsite service upgrade options (in eligible locations):⁷ <ul style="list-style-type: none"> • 1-year LOR 9x5, 4 hour response (ThinkPlus™ part number 41C9189) • 2-year LOR 9x5, Next Business Day (ThinkPlus part number 41C9187) • 2-year LOR 9x5, 4 hour response (ThinkPlus part number 41C9190) • 3-year LOR 9x5, Next Business Day (ThinkPlus part number 41C9188) • 3-year LOR 9x5, 4 hour response (ThinkPlus part number 41C9191) ↔ ThinkPlus services at lenovo.com/thinkplus/warranty ↔ Post warranty maintenance services available ↔ 24 hour x 7 day¹⁴ toll-free support during the warranty period¹ via 800-426-7378 	
Keyboard	Preferred Pro USB Keyboard (USB connector), 104-key, black, Lenovo logo		Accessories		1GB PC2-6400 NP DDR2 UDIMM 41U2977 2GB PC2-6400 NP DDR2 UDIMM 41U2978 250GB SATA 3.0Gb/s Disk (7200 rpm) 41N3015 500GB SATA 3.0Gb/s Disk (7200 rpm) 43R1990 USB Portable Diskette Drive 05K9276 USB 2.0 Lenovo Multimedia Headset 40Y8518 USB 2.0 Lenovo Webcam 40Y8519 USB 2.0 Essential Memory Key 32GB 45K1258 USB 2.0 Ultra Secure Memory Key 2GB 45J5916 USB 2.0 Ultra Secure Memory Key 4GB 45J5917 USB 2.0 Ultra Secure Memory Key 8GB 45J5918 USB 2.0 Portable 160GB Hard Disk 43R1784 USB 2.0 Portable Secure 320GB Hard Disk 43R2019 ThinkVision® L1700p 17" Monitor 9417HE2 ThinkVision L1940p Wide 19" Monitor 4424HB6 ThinkVision L2240p Wide 22" Monitor 4422HB6 ThinkVision L2440p Wide 24" Monitor 4420HB2 ThinkVision L2440x Wide 24" Monitor 4421HB2 Wireless Kbd & Opt Wheel Mouse (via USB) 73P4067 Laser Tilt Wheel Mouse (USB, PS/2) 41U3074 Kensington Cable Lock from Lenovo 73P2582 ATI Radeon HD 2400 XT 256MB 43R1962 ATI Radeon HD 3470 256MB (DP, VGA) 45K1636 NVIDIA® GeForce® 9500GT 512MB (DP, DVI) 45K1635 Acc Guide in pdf lenovo.com/accessoriesguide Other accessories at lenovo.com/accessories		Preloaded operating system²⁰ <ul style="list-style-type: none"> - Microsoft® Windows® Vista® Home Premium Edition (32-bit) ◇ Vista Premium logo Preloaded applications⁵ <ul style="list-style-type: none"> • Rescue and Recovery™ • Client Security Solution™ • ThinkVantage Productivity Center • ThinkVantage System Update • Norton Internet Security™ (90 days of virus definitions) • Diskeeper® Home • PC-Doctor™ (diagnostics) • Adobe® Reader • Windows Live™ Toolbar • Windows Live Search • Picasa from Google • Microsoft Office 2007 Trial (60-day) • EarthLink Trial • Sonic RecordNow and Drive Letter Access (DVD±RW) • Corel® WinDVD® (DVD±RW) 	
Mouse	Optical Wheel Mouse (USB connector), 400dpi, black, Lenovo logo							
Power supply	280 watts with variable speed fan, manual switch							

See footnotes for important warranty information
 US model announced December 16, 2008

ThinkCentre® A62 Tower (9935) - TopSeller

Personal Systems Reference (PSREF)

Name	Type-model	Slot x bay	AMD processor	GHz	Core	Memory ⁸	SATA disk	2nd Disk Bay	SATA optical	Integrated graphics	Monitor connectors	Preload	Global Educ	Avail date
A62	9935-B1U	4x4	Athlon 1640B	2.7	Single	1GB	160GB ²	None	DVD	3100	VGA, DVI-D	XP Pro	None	Sep 08
A62	9935-B6U	4x4	Athlon X2 4450B	2.3	Dual	1GB	160GB	None	DVD	3100	VGA, DVI-D	XP Pro	None	Sep 08
A62	9935-B7U	4x4	Athlon X2 4450B	2.3	Dual	2GB	160GB	None	DVD±RW	3100	VGA, DVI-D	XP Pro	None	Sep 08
A62	9935-B2U	4x4	Athlon X2 5000B	2.6	Dual	1GB	160GB	None	DVD	3100	VGA, DVI-D	XP Pro	None	Sep 08
A62	9935-B3U	4x4	Athlon X2 5000B	2.6	Dual	2GB	160GB	None	DVD±RW	3100	VGA, DVI-D	XP Pro	None	Sep 08
A62	9935-B4U	4x4	Phenom X3 8450	2.1	Triple	1GB	160GB	None	DVD±RW	3100	VGA, DVI-D	XP Pro	None	Sep 08
A62	9935-B5U	4x4	Phenom X3 8450	2.1	Triple	2GB	320GB	None	DVD±RW	3100	VGA, DVI-D	XP Pro	None	Sep 08

• **These small and medium business (SMB) models are part of the US TopSeller™ Program**
 • **These models have a 3-year limited warranty¹**

Positioning Processor	Quality, reliability, and manageability for small/medium businesses AMD® Athlon™ Processor 1640B with single-core, virtualization technology, int DDR2 memory controller, and 512KB L2 cache or AMD Athlon X2 Dual-Core Processor 4450B or 5000B with dual-core, virtualization technology, integrated DDR2 memory controller, and 1MB dedicated L2 cache or AMD Phenom™ X3 Triple-Core Processor 8450 with triple-core, virtualization technology, integrated DDR2 memory controller, 1.5MB dedicated L2 cache and 2MB shared L3 cache Processor in Socket AM2 or AM2+	Tower <ul style="list-style-type: none"> Business black color 6.9" W X 17.3" D X 15.8" H 175mm W X 440mm D X 402mm H 24.2lb (11.0kg) in typical configuration Handle on top front Toolless cover removal Toolless disk, diskette drive, optical drive removal Toolless adapter retention 
Implementation		
Memory	1GB or 2GB std , 8GB max ⁸ , PC2-5300 667MHz DDR2 , non-parity, dual-channel capable, four 240-pin DIMM sockets; <i>Italics:</i> standard memory in two sockets; two sockets available; <i>Non-italics:</i> standard memory in one socket; three sockets available	Bay ① 5.25", 1.6" high, access, std optical Bay ② 5.25", 1.6" high, access, open Bay ③ 3.5", 1" high, access, open (reader/diskette) Bay ④ 3.5", 1" high, no access, std disk
Graphics	ATI™ Radeon™ 3100 , integrated graphics in 780V, uses main memory (up to 512MB), one analog VGA DB-15 connector, one DVI-D connector, DirectX® 10, ATI Avivo™, SurroundView™, supports dual independent display; supports up to 4 independent monitors with optional dual-head ATI graphics adapter	Slot 1: half-length, full-height, PCIe 2.0 x1 Slot 2: half-length, full-height, PCIe 2.0 x16 (75w max) Slot 3: half-length, full-height, 32-bit PCI 2.3 Slot 4: half-length, full-height, 32-bit PCI 2.3
SATA disk	160GB or 320GB , SATA 3.0Gb/s 7200 rpm, vibration dampening mounts	Security <ul style="list-style-type: none"> Security chip (see information on left) One lock to secure both cover and entire system to fixed object: <ul style="list-style-type: none"> Padlock loop (in rear for opt padlock) Security slot (in rear for optional Kensington® Microsaver® cable) Power-on password Administrator password Hard disk password Boot sequence control Boot without keyboard, mouse, diskette Serial port I/O control Parallel port I/O control Individual USB port disablement Supports ThinkVantage® technologies GREENGUARD® certified RoHS-compliant Limited Warranty¹ <ul style="list-style-type: none"> 3-year parts and labor International Warranty Service⁹ Customer Replaceable Unit (CRU) parts only (with limited onsite service for selected parts³, 8 am - 5 pm, Mon - Fri coverage excluding holidays, next business day response time) Onsite service upgrade options (in eligible locations):⁷ <ul style="list-style-type: none"> 3-year LOR 9x5, 4 hour response (ThinkPlus™ part number 41C9192) 3-year LOR 24x7, 4 hour response (ThinkPlus part number 41C9193) 4-year LOR 9x5, Next Business Day (ThinkPlus part number 41C9194) 4-year LOR 9x5, 4 hour response (ThinkPlus part number 41C9195) 4-year LOR 24x7, 4 hour response (ThinkPlus part number 41C9196) ThinkPlus services at lenovo.com/thinkplus/warranty Post warranty maintenance services available 24 hour x 7 day¹⁴ toll-free support during the warranty period¹ via 800-426-7378
SATA controller	Serial ATA, SATA 3.0Gb/s, integrated in SB700, RAID 0/1 support	
SATA DVD	<i>Some:</i> DVD-ROM DL SATA 1.5Gb/s 16X-48X Max ⁴ Drive (41N5618)	
SATA DVD±RW	<i>Some:</i> Super Multi-Burner DL DVD±RW SATA 1.5Gb/s Drive (41N5620)	
SATA cables	Two SATA cables (each 1-drop to device), four SATA connectors on planar	
eSATA port	None	
EIDE controller	None	
Diskette drive	None	
Media reader	None	
Chipset	AMD 780V Chipset with HyperTransport™ 3.0 and PCI Express® 2.0 support; SB700 south bridge for SATA 3.0Gb/s with RAID 0/1 support, ATA-133 EIDE, PCI 2.3, USB, LPC bus / Winbond® W83627DHG Super I/O	
Front ports	Two USB 2.0, microphone (stereo, 3.5mm), headphone (stereo, 3.5mm)	
Rear ports	Six USB 2.0, serial (9-pin), parallel (25-pin), keyboard (PS/2), mouse (PS/2), ethernet (RJ-45), monitor (VGA DB-15, DVI-D)	
Internal connector	Two USB 2.0 planar conn (1 used; one open for media reader or 2 rear USB ports)	
Rear audio ports	Line-in (stereo, 3.5mm), line-out (stereo, 3.5mm), microphone-in (stereo, 3.5mm)	
Audio	High Definition (HD) Audio, Realtek® ALC662 codec	
Speaker	One internal speaker for business audio	
Ethernet	Gigabit ethernet on planar, Marvell® 88E8070, Wake on LAN®, ASF 2.0	
Modem	None	
Security chip	Winbond WPCT200 SafeKeeper™ Trusted Platform Module, TCG 1.2-compliant	
Keyboard	Preferred Pro USB Keyboard (USB connector), 104-key, black, Lenovo logo	
Mouse	Optical Wheel Mouse (USB connector), 400dpi, black, Lenovo logo	
Power supply	280 watts with variable speed fan, manual switch	
Preloaded operating system²⁰	Accessories	
- Microsoft® Windows® XP Professional with Vista® COA	1GB PC2-5300 CL5 NP DDR2 UDIMM	73P4984
◆ Disk-to-Disk Recovery (in hidden protected area)	2GB PC2-5300 CL5 NP DDR2 UDIMM	73P4985
◆ Vista Basic logo	250GB SATA 3.0Gb/s Disk (7200 rpm)	41N3015
	500GB SATA 3.0Gb/s Disk (7200 rpm)	43R1990
	USB Portable Diskette Drive	05K9276
	USB 2.0 Lenovo Multimedia Headset	40Y8518
	USB 2.0 Lenovo Webcam	40Y8519
	USB 2.0 Essential Memory Key 32GB	45K1258
	USB 2.0 Ultra Secure Memory Key 8GB	45J5918
	USB 2.0 Portable 160GB Hard Disk	43R1784
	USB 2.0 Portable Secure 320GB Hard Disk	43R2019
	ThinkVision® L1940p Wide 19" Monitor	4424HB6
	ThinkVision L2240p Wide 22" Monitor	4422HB6
	ThinkVision L2440p Wide 24" Monitor	4420HB2
	Wireless Kbd & Opt Wheel Mouse (via USB)	73P4067
	Laser Tilt Wheel Mouse (USB, PS/2)	41U3074
	Kensington Cable Lock from Lenovo	73P2582
	ATI Radeon HD 2400 XT 256MB	43R1962
	ATI Radeon HD 3470 256MB (DP, VGA)	45K1636
	NVIDIA® GeForce® 9500GT 512MB (DP, DVI)	45K1635
	Acc Guide in pdf lenovo.com/accessoriesguide	
	Other accessories at lenovo.com/accessories	

See footnotes for important warranty information
US models announced September 9, 2008

ThinkCentre® A62 Tower (9485)

Personal Systems Reference (PSREF)

Name	Type-model	Slot x bay	AMD processor	GHz	Core	Memory ⁸	SATA disk	2nd Disk Bay	SATA optical	Graphics	Monitor connectors	Preload	Global Educ	Avail date
A62	9485-E4U	4x5	Athlon 1640B	2.7	Single	1GB	160GB ²	Bay	DVD	3100	VGA, DVI-D	XP Pro	None	Sep 08
A62	9485-E5U	4x5	Athlon X2 5000B	2.6	Dual	1GB	160GB	Bay	DVD	3100	VGA, DVI-D	XP Pro	None	Sep 08
A62	9485-E6U	4x5	Athlon X2 5000B	2.6	Dual	1GB	160GB	Bay	DVD±RW	3100	VGA, DVI-D	XP Pro	None	Sep 08
A62	9485-E7U	4x5	Athlon X2 5000B	2.6	Dual	2GB	160GB	Bay	DVD±RW	3100	VGA, DVI-D	XP Pro	None	Sep 08
A62	9485-E8U	4x4	Athlon X2 5400B	2.8	Dual	1GB	250GB		DVD	3100	VGA, DVI-D	XP Pro	None	Sep 08
A62	9485-E9U	4x5	Athlon X2 5400B	2.8	Dual	2GB	250GB	Bay	DVD±RW	3100	VGA, DVI-D	XP Pro	None	Sep 08
A62	9485-F1U	4x5	Phenom X3 8450	2.1	Triple	1GB	160GB	Bay	DVD	3100	VGA, DVI-D	XP Pro	None	Sep 08
A62	9485-F2U	4x5	Phenom X3 8450	2.1	Triple	2GB	160GB	Bay	DVD±RW	9300GE	VGA, DVI-I	XP Pro	None	Sep 08

• These models have a 3-year limited warranty¹

Positioning Processor	<i>Stability and manageability for large enterprise and mid-market</i> AMD® Athlon™ Processor 1640B with single-core, virtualization technology, int DDR2 memory controller, and 512KB L2 cache or AMD Athlon X2 Dual-Core Processor 5000B or 5400B with dual-core , virtualization technology, integrated DDR2 memory controller, and 1MB dedicated L2 cache or AMD Phenom™ X3 Triple-Core Processor 8450 with triple-core , virtualization technology, integrated DDR2 memory controller, 1.5MB dedicated L2 cache and 2MB shared L3 cache Processor in Socket AM2 or AM2+	<p>Tower</p> <ul style="list-style-type: none"> • Business black color • 6.9" W X 17.3" D X 15.8" H • 175mm W X 440mm D X 402mm H • 24.2lb (11.0kg) in typical configuration • Handle on top front • Toolless cover removal • Toolless disk, diskette drive, optical drive removal • Toolless adapter retention
Implementation		
Memory	1GB or 2GB std , 8GB max ⁸ , PC2-5300 667MHz DDR2 , non-parity, dual-channel capable, four 240-pin DIMM sockets; <i>Italics:</i> standard memory in two sockets; two sockets available; <i>Non-italics:</i> standard memory in one socket; three sockets available	
Graphics	<i>Some:</i> ATI™ Radeon™ 3100 , int graphics in 780V, uses main memory (up to 512MB), one analog VGA DB-15 connector, one DVI-D conn, DirectX® 10, ATI Avivo™, SurroundView™, supports dual independent display; supports up to 4 monitors with optional dual-head ATI graphics adapter <i>Some:</i> NVIDIA® GeForce® 9300 GE , PCI Express® x16 adapter, 256MB, one analog VGA DB-15 conn via cable, one DVI-I conn, S-Video out for TV-out, HDCP, DirectX 10, 30 watts	
SATA disk	160GB or 250GB , SATA 3.0Gb/s 7200 rpm, vibration dampening	<p>Bay ① 5.25", 1.6" high, access, std optical Bay ② 5.25", 1.6" high, access, open Bay ③ 3.5", 1" high, access, open (reader/diskette) Bay ④ 3.5", 1" high, no access, std disk Bay ⑤ 3.5", 1" high, no access, opt disk*</p> <p>* 2nd Disk Bay is only available on some models</p> <p>Slot 1: half-length, full-height, PCIe 2.0 x1 Slot 2: half-length, full-height, PCIe 2.0 x16 (75w max)** Slot 3: half-length, full-height, 32-bit PCI 2.3 Slot 4: half-length, full-height, 32-bit PCI 2.3</p> <p>** used in some models</p>
SATA controller	Serial ATA, SATA 3.0Gb/s, integrated in SB700, RAID 0/1 support	
SATA DVD	<i>Some:</i> DVD-ROM DL SATA 1.5Gb/s 16X-48X Max ⁴ Drive (41N5618)	
SATA DVD±RW	<i>Some:</i> Super Multi-Burner DL DVD±RW SATA 1.5Gb/s Drive (41N5620)	
SATA cables	Two SATA cables (each 1-drop to device), four SATA connectors on planar	
eSATA port	None	
EIDE controller	None	
Diskette drive	None	
Media reader	None	
Chipset	AMD 780V Chipset with HyperTransport™ 3.0 and PCI Express 2.0 support; SB700 south bridge for SATA 3.0Gb/s with RAID 0/1 support, ATA-133 EIDE, PCI 2.3, USB, LPC bus / Winbond® W83627DHG Super I/O	
Front ports	Two USB 2.0, microphone (stereo, 3.5mm), headphone (stereo, 3.5mm)	
Rear ports	Six USB 2.0, serial (9-pin), parallel (25-pin), keyboard (PS/2), mouse (PS/2), ethernet (RJ-45), <i>F2U:</i> monitor (VGA DB-15, DVI-I), S-Video out; <i>Others:</i> monitor (VGA DB-15, DVI-D)	
Internal connector	Two USB 2.0 planar conn (1 used; one open for media reader or 2 rear USB ports)	
Rear audio ports	Line-in (stereo, 3.5mm), line-out (stereo, 3.5mm), microphone-in (stereo, 3.5mm)	
Audio	High Definition (HD) Audio, Realtek® ALC662 codec	
Speaker	One internal speaker for business audio	
Ethernet	Gigabit ethernet on planar, Marvel® 88E8070, Wake on LAN®, ASF 2.0	
Modem	None	
Security chip	Winbond WPCT200 SafeKeeper™ Trusted Platform Module, TCG 1.2-compliant	
Keyboard	Preferred Pro USB Keyboard (USB connector), 104-key, black, Lenovo logo	
Mouse	Optical Wheel Mouse (USB connector), 400dpi, black, Lenovo logo	
Power supply	280 watts with variable speed fan, manual switch	
Preloaded operating system²⁰	Accessories	<p>Security</p> <ul style="list-style-type: none"> • Security chip (see information on left) • One lock to secure both cover and entire system to fixed object: <ul style="list-style-type: none"> - Padlock loop (in rear for opt padlock) - Security slot (in rear for optional Kensington® Microsaver® cable) • Power-on password • Administrator password • Hard disk password • Boot sequence control • Boot without keyboard, mouse, diskette • Serial port I/O control • Parallel port I/O control • Individual USB port disablement <p>Supports ThinkVantage® technologies</p> <p>GREENGUARD® certified RoHS-compliant</p> <p>Limited Warranty¹</p> <ul style="list-style-type: none"> ↪ 3-year parts and labor ↪ International Warranty Service⁹ ↪ Customer Replaceable Unit (CRU) parts only (with limited onsite service for selected parts³, 8 am - 5 pm, Mon - Fri coverage excluding holidays, next business day response time) ↪ Onsite service upgrade options (in eligible locations):⁷ <ul style="list-style-type: none"> • 3-year LOR 9x5, 4 hour response (ThinkPlus™ part number 41C9192) • 3-year LOR 24x7, 4 hour response (ThinkPlus part number 41C9193) • 4-year LOR 9x5, Next Business Day (ThinkPlus part number 41C9194) • 4-year LOR 9x5, 4 hour response (ThinkPlus part number 41C9195) • 4-year LOR 24x7, 4 hour response (ThinkPlus part number 41C9196) ↪ ThinkPlus services at lenovo.com/thinkplus/warranty ↪ 24 hour x 7 day¹⁴ toll-free support during the warranty period¹
- Microsoft® Windows® XP Professional with Vista® COA	1GB PC2-5300 CL5 NP DDR2 UDIMM 73P4984	
◇ Disk-to-Disk Recovery (in hidden protected area)	2GB PC2-5300 CL5 NP DDR2 UDIMM 73P4985	
◇ Vista Basic logo	500GB SATA 3.0Gb/s Disk (7200 rpm) 43R1990	
	USB 2.0 Lenovo Multimedia Headset 40Y8518	
	USB 2.0 Lenovo Webcam 40Y8519	
	USB 2.0 Essential Memory Key 32GB 45K1258	
	USB 2.0 Portable Secure 320GB Hard Disk 43R2019	
Preloaded applications⁵ (only some listed)	ThinkVision® L2240p Wide 22" Monitor 4422HB6	
• Rescue and Recovery™	ThinkVision L2440p Wide 24" Monitor 4420HB2	
• Client Security Solution™	Wireless Kbd & Opt Wheel Mouse (via USB) 73P4067	
• ThinkVantage Productivity Center	Laser Tilt Wheel Mouse (USB, PS/2) 41U3074	
• Microsoft Office 2007 Trial (60-day)	Kensington Cable Lock from Lenovo 73P2582	
• Multimedia Center for Think Offerings (DVD, DVD±RW)	ATI Radeon HD 2400 XT 256MB 43R1962	
• Sonic RecordNow and Drive Letter Access (DVD±RW)	ATI Radeon HD 3470 256MB (DP, VGA) 45K1636	
• Corel® WinDVD® (DVD, DVD±RW)	NVIDIA® GeForce® 9500GT 512MB (DP, DVI) 45K1635	
• Corel WinDVD Creator (DVD±RW)	Acc Guide in pdf lenovo.com/accessoriesguide	
	Other accessories at lenovo.com/accessories	

See footnotes for important warranty information
US models announced September 9, 2008

© Lenovo
(ATHN1-8) September 2008

Name	Type-model	Slot x bay	AMD processor	GHz	Core	Memory ⁸	SATA disk	2nd Disk Bay	SATA optical	Graphics	Monitor connectors	Vista preload	Global Educ	Avail date
A62	9485-A4U	4x5	Athlon 1640B	2.7	Single	1GB	160GB ²	Bay	DVD	3100	VGA, DVI-D	Bus32		Sep 08
A62	9485-F9U	4x4	Athlon X2 4450B	2.3	Dual	1GB	160GB		DVD	3100	VGA, DVI-D	Bus32		Sep 08
A62	9485-F8U	4x5	Athlon X2 4450B	2.3	Dual	1GB	160GB	Bay	DVD±RW	9300GE	VGA, DVI-I	Bus32		Sep 08
A62	9485-H1U	4x4	Athlon X2 4450B	2.3	Dual	2GB	160GB		DVD±RW	3100	VGA, DVI-D	Bus32	Educ	Sep 08
A62	9485-E2U	4x4	Athlon X2 5000B	2.6	Dual	1GB	160GB		DVD±RW	3100	VGA, DVI-D	Bus32		Sep 08
A62	9485-A1U	4x4	Athlon X2 5400B	2.8	Dual	2GB	160GB		DVD±RW	3100	VGA, DVI-D	Bus32		Sep 08
A62	9485-A2U	4x5	Phenom X3 8600B	2.3	Triple	2GB	160GB	Bay	DVD±RW	3100	VGA, DVI-D	Bus64		Sep 08

• **These models have a 3-year limited warranty¹**

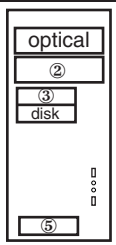
Positioning Processor	<i>Stability and manageability for large enterprise and mid-market</i> AMD Athlon™ Processor 1640B with single-core, virtualization technology, int DDR2 memory controller, and 512KB L2 cache or AMD Athlon X2 Dual-Core Processor 4450B, 5000B, or 5400B with dual-core, virtualization technology, integrated DDR2 memory controller, and 1MB dedicated L2 cache or AMD Phenom™ X3 Triple-Core Processor 8600B with triple-core, virtualization technology, integrated DDR2 memory controller, 1.5MB dedicated L2 cache and 2MB shared L3 cache Processor in Socket AM2 or AM2+	Tower <ul style="list-style-type: none"> Business black color 6.9" W X 17.3" D X 15.8" H 175mm W X 440mm D X 402mm H 24.2lb (11.0kg) in typical configuration Handle on top front Toolless cover removal Toolless disk, diskette drive, optical drive removal Toolless adapter retention 	
Implementation			
Memory	1GB or 2GB std, 8GB max⁸ , four 240-pin DIMM sockets; <i>Italics:</i> standard memory in two sockets; two sockets available; <i>Non-italics:</i> standard memory in one socket; three sockets available; <i>Fxx/H1U:</i> PC2-5300 667MHz DDR2 , non-parity, dual-channel; <i>Others:</i> PC2-6400 800MHz DDR2 , non-parity, dual-channel	<ul style="list-style-type: none"> Bay ① 5.25", 1.6" high, access, std optical Bay ② 5.25", 1.6" high, access, open Bay ③ 3.5", 1" high, access, open (reader/diskette) Bay ④ 3.5", 1" high, no access, std disk Bay ⑤ 3.5", 1" high, no access, opt disk* 	
Graphics	<i>Some:</i> ATI™ Radeon™ 3100 , int graphics in 780V, uses main memory (up to 512MB), one analog VGA DB-15 connector, one DVI-D conn, DirectX® 10, ATI Avivo™, SurroundView™, supports dual independent display; supports up to 4 monitors with optional dual-head ATI graphics adapter <i>Some:</i> NVIDIA® GeForce® 9300 GE , PCI Express® x16 adapter, 256MB, one analog VGA DB-15 conn via cable, one DVI-I conn, S-Video out for TV-out, HDCP, DirectX 10, 30 watts	* 2nd Disk Bay is only available on some models Slot 1: half-length, full-height, PCIe 2.0 x1 Slot 2: half-length, full-height, PCIe 2.0 x16 (75w max)** Slot 3: half-length, full-height, 32-bit PCI 2.3 Slot 4: half-length, full-height, 32-bit PCI 2.3 ** used in some models	
SATA disk	160GB , SATA 3.0Gb/s 7200 rpm, vibration dampening mounts		
SATA controller	Serial ATA, SATA 3.0Gb/s, integrated in SB700, RAID 0/1 support		
SATA DVD	<i>Some:</i> DVD-ROM DL SATA 1.5Gb/s 16X-48X Max ⁴ Drive (41N5618)		
SATA DVD±RW	<i>Some:</i> Super Multi-Burner DL DVD±RW SATA 1.5Gb/s Drive (41N5620)		
SATA cables	Two SATA cables (each 1-drop to device), four SATA connectors on planar		
eSATA port	None		
EIDE controller	None		
Diskette drive	None		
Media reader	None		
Chipset	AMD 780V Chipset with HyperTransport™ 3.0 and PCI Express 2.0 support; SB700 south bridge for SATA 3.0Gb/s with RAID 0/1 support, ATA-133 EIDE, PCI 2.3, USB, LPC bus / Winbond® W83627DHG Super I/O		
Front ports	Two USB 2.0, microphone (stereo, 3.5mm), headphone (stereo, 3.5mm)		
Rear ports	Six USB 2.0, serial (9-pin), parallel (25-pin), keyboard (PS/2), mouse (PS/2), ethernet (RJ-45), <i>F8U:</i> monitor (VGA DB-15, DVI-I), S-Video out; <i>Others:</i> monitor (VGA DB-15, DVI-D)		
Internal connector	Two USB 2.0 planar conn (1 used; one open for media reader or 2 rear USB ports)		
Rear audio ports	Line-in (stereo, 3.5mm), line-out (stereo, 3.5mm), microphone-in (stereo, 3.5mm)		
Audio	High Definition (HD) Audio, Realtek® ALC662 codec		
Speaker	One internal speaker for business audio		
Ethernet	Gigabit ethernet on planar, Marvel® 88E8070, Wake on LAN®, ASF 2.0		
Modem	None		
Security chip	Winbond WPCT200 SafeKeeper™ Trusted Platform Module, TCG 1.2-compliant		
Keyboard	Preferred Pro USB Keyboard (USB connector), 104-key, black, Lenovo logo		
Mouse	Optical Wheel Mouse (USB connector), 400dpi, black, Lenovo logo		
Power supply	280 watts with variable speed fan, manual switch		
Preloaded operating system²⁰	Accessories		
- <i>Some:</i> Microsoft® Windows® Vista Business Edition (32-bit)	1GB PC2-5300 CL5 NP DDR2 UDIMM 73P4984		
- <i>Some:</i> Microsoft Windows Vista Business Edition (64-bit)	2GB PC2-5300 CL5 NP DDR2 UDIMM 73P4985		
◇ Vista Premium logo	1GB PC2-6400 NP DDR2 UDIMM 41U2977		
Preloaded applications⁵ (all OSes; only some listed)	2GB PC2-6400 NP DDR2 UDIMM 41U2978		
• <i>Some:</i> Education software	500GB SATA 3.0Gb/s Disk (7200 rpm) 43R1990		
- VitalSource Library College Edition	USB 2.0 Lenovo Multimedia Headset 40Y8518		
- Adobe® Instructor Resource Center	USB 2.0 Lenovo Webcam 40Y8519		
- Adobe Digital School Collection	USB 2.0 Ultra Secure Memory Key 8GB 45J5918		
- Photoshop Elements 6 (and CD)	USB 2.0 Portable Secure 320GB Hard Disk 43R2019		
- Premier Elements 4 (and DVD)	ThinkVision® L2440p Wide 24" Monitor 4420HB2		
- Acrobat 8 Professional (and CD)	Wireless Kbd & Opt Wheel Mouse (via USB) 73P4067		
- Contribute 4 (and CD)	Kensington Cable Lock from Lenovo 73P2582		
• Rescue and Recovery™	ATI Radeon HD 2400 XT 256MB 43R1962		
	ATI Radeon HD 3470 256MB (DP, VGA) 45K1636		
	NVIDIA® GeForce® 9500GT 512MB (DP, DVI) 45K1635		
	Acc Guide in pdf lenovo.com/accessoriesguide		
	Other accessories at lenovo.com/accessories		
		Security	
		<ul style="list-style-type: none"> Security chip (see information on left) One lock to secure both cover and entire system to fixed object: <ul style="list-style-type: none"> Padlock loop (in rear for opt padlock) Security slot (in rear for optional Kensington® Microsaver® cable) Power-on password Administrator password Hard disk password Boot sequence control Boot without keyboard, mouse, diskette Serial port I/O control Parallel port I/O control Individual USB port disablement 	
		Supports ThinkVantage® technologies	
		GREENGUARD® certified RoHS-compliant	
		Limited Warranty¹	
		<ul style="list-style-type: none"> 3-year parts and labor International Warranty Service® Customer Replaceable Unit (CRU) parts only (with limited onsite service for selected parts³, 8 am - 5 pm, Mon - Fri coverage excluding holidays, next business day response time) Onsite service upgrade options (in eligible locations):⁷ <ul style="list-style-type: none"> 3-year LOR 9x5, 4 hour response (ThinkPlus™ part number 41C9192) 3-year LOR 24x7, 4 hour response (ThinkPlus part number 41C9193) 4-year LOR 9x5, Next Business Day (ThinkPlus part number 41C9194) 4-year LOR 9x5, 4 hour response (ThinkPlus part number 41C9195) 4-year LOR 24x7, 4 hour response (ThinkPlus part number 41C9196) ThinkPlus services at lenovo.com/thinkplus/warranty 24 hour x 7 day¹⁴ toll-free support during the warranty period¹ via 800-426-7378 	

See footnotes for important warranty information

US models announced September 9, 2008; previous models on August 12, 2008

ThinkCentre® A62 Tower (9625) - ENERGY STAR® 4.0

Personal Systems Reference (PSREF)

Name	Type-model	Slot x bay	AMD processor	GHz	Core	Memory ^a	SATA disk	2nd Disk Bay	SATA optical	Graphics	Monitor connectors	ENERGY STAR 4.0	Preload	Global Educ	Avail date
A62	9625-B5U	4x4	Athlon X2 5000B	2.6	Dual	1GB	160GB ²		DVD	3100	VGA, DVI-D	ES40	XP Pro	None	Sep 08
A62	9625-B6U	4x4	Athlon X2 5000B	2.6	Dual	2GB	160GB		DVD±RW	3100	VGA, DVI-D	ES40	XP Pro	None	Sep 08
A62	9625-B7U	4x4	Athlon X2 5400B	2.8	Dual	2GB	250GB		DVD±RW	3100	VGA, DVI-D	ES40	XP Pro	None	Sep 08
A62	9625-B9U	4x4	Athlon X2 5400B	2.8	Dual	2GB	160GB		DVD±RW	9300GE	VGA, DVI-I	ES40	XP Pro	None	Sep 08
A62	9625-B8U	4x4	Phenom X3 8450	2.1	Triple	2GB	160GB		DVD	3100	VGA, DVI-D	ES40	XP Pro	None	Dec 08
A62	9625-A3U	4x5	Athlon 1640B	2.7	Single	1GB	160GB	Bay	DVD	3100	VGA, DVI-D	ES40	Bus32	None	Sep 08
A62	9625-D2U	4x4	Athlon X2 4450B	2.3	Dual	1GB	160GB		DVD±RW	3100	VGA, DVI-D	ES40	Bus32	None	Sep 08
A62	9625-A2U	4x5	Athlon X2 5000B	2.6	Dual	1GB	160GB	Bay	DVD±RW	3100	VGA, DVI-D	ES40	Bus32	None	Sep 08
A62	9625-A1U	4x5	Phenom X3 8600B	2.3	Triple	2GB	160GB	Bay	DVD±RW	3100	VGA, DVI-D	ES40	Bus64	None	Dec 08

• These models have a 3-year limited warranty¹

Positioning Processor	<p><i>Stability and manageability for large enterprise and mid-market</i></p> <p>AMD® Athlon™ Processor 1640B with single-core, virtualization technology, int DDR2 memory controller, and 512KB L2 cache or AMD Athlon X2 Dual-Core Processor 4450B, 5000B, or 5400B with dual-core, virtualization technology, integrated DDR2 memory controller, and 1MB dedicated L2 cache or AMD Phenom™ X3 Triple-Core Processor 8450 or 8600B with triple-core, virtualization technology, integrated DDR2 memory controller, 1.5MB dedicated L2 cache and 2MB shared L3 cache Processor in Socket AM2 or AM2+</p>		<p>Tower</p> <ul style="list-style-type: none"> • Business black color • 6.9" W X 17.3" D X 15.8" H • 175mm W X 440mm D X 402mm H • 24.2lb (11.0kg) in typical configuration • Handle on top front • Toolless cover removal • Toolless disk, diskette drive, optical drive removal • Toolless adapter retention 	
Implementation				
Memory	<p>1GB or 2GB std, 8GB max⁸, four 240-pin DIMM sockets;</p> <p><i>Italics:</i> standard memory in two sockets; two sockets available;</p> <p><i>Non-italics:</i> standard memory in one socket; three sockets available;</p> <p><i>D2U:</i> PC2-5300 667MHz DDR2, non-parity, dual-channel capable;</p> <p><i>Others:</i> PC2-6400 800MHz DDR2, non-parity, dual-channel capable</p>		<p>Bay ① 5.25", 1.6" high, access, std optical</p> <p>Bay ② 5.25", 1.6" high, access, open</p> <p>Bay ③ 3.5", 1" high, access, open (reader/diskette)</p> <p>Bay ④ 3.5", 1" high, no access, std disk</p> <p>Bay ⑤ 3.5", 1" high, no access, opt disk*</p>	
Graphics	<p><i>Some:</i> ATI™ Radeon™ 3100, int graphics in 780V, uses main memory (up to 512MB), one analog VGA DB-15 connector, one DVI-D conn, DirectX® 10, ATI Avivo™, SurroundView™, supports dual independent display; supports up to 4 monitors with optional dual-head ATI graphics adapter</p> <p><i>Some:</i> NVIDIA® GeForce® 9300 GE, PCI Express® x16 adapter, 256MB, one analog VGA DB-15 conn via cable, one DVI-I conn, S-Video out for TV-out, HDCP, DirectX 10, 30 watts</p>		<p>* 2nd Disk Bay is only available on some models</p> <p>Slot 1: half-length, full-height, PCIe 2.0 x1</p> <p>Slot 2: half-length, full-height, PCIe 2.0 x16 (75w max)**</p> <p>Slot 3: half-length, full-height, 32-bit PCI 2.3</p> <p>Slot 4: half-length, full-height, 32-bit PCI 2.3</p> <p>** used in some models</p>	
SATA disk	<p>160GB or 250GB, SATA 3.0Gb/s 7200 rpm, vibration dampening mounts</p>		<p>Security</p> <ul style="list-style-type: none"> • Security chip (see information on left) • One lock to secure both cover and entire system to fixed object: <ul style="list-style-type: none"> - Padlock loop (in rear for opt padlock) - Security slot (in rear for optional Kensington® Microsaver® cable) • Power-on password • Administrator password • Hard disk password • Boot sequence control • Boot without keyboard, mouse, diskette • Serial port I/O control • Parallel port I/O control • Individual USB port disablement 	
SATA controller	<p>Serial ATA, SATA 3.0Gb/s, integrated in SB700, RAID 0/1 support</p>			
SATA DVD	<p><i>Some:</i> DVD-ROM DL SATA 1.5Gb/s 16X-48X Max⁴ Drive (41N5618)</p>			
SATA DVD±RW	<p><i>Some:</i> Super Multi-Burner DL DVD±RW SATA 1.5Gb/s Drive (41N5620)</p>			
SATA cables	<p>Two SATA cables (each 1-drop to device), four SATA connectors on planar</p>			
eSATA port	<p>None</p>			
EIDE controller	<p>None</p>			
Diskette drive	<p>None</p>			
Media reader	<p>None</p>			
Chipset	<p>AMD 780V Chipset with HyperTransport™ 3.0 and PCI Express 2.0 support; SB700 south bridge for SATA 3.0Gb/s with RAID 0/1 support, ATA-133 EIDE, PCI 2.3, USB, LPC bus / Winbond® W83627DHG Super I/O</p>		<p>Supports ThinkVantage® technologies</p>	
Front ports	<p>Two USB 2.0, microphone (stereo, 3.5mm), headphone (stereo, 3.5mm)</p>		<p>EPEAT™ Gold rating</p>	
Rear ports	<p>Six USB 2.0, serial (9-pin), parallel (25-pin), keyboard (PS/2), mouse (PS/2), ethernet (RJ-45),</p> <p><i>B9U:</i> monitor (VGA DB-15, DVI-I), S-Video out;</p> <p><i>Others:</i> monitor (VGA DB-15, DVI-D)</p>		<p>ENERGY STAR 4.0-compliant</p>	
Internal connector	<p>Two USB 2.0 planar conn (1 used; one open for media reader or 2 rear USB ports)</p>		<p>GREENGUARD® certified</p>	
Rear audio ports	<p>Line-in (stereo, 3.5mm), line-out (stereo, 3.5mm), microphone-in (stereo, 3.5mm)</p>		<p>RoHS-compliant</p>	
Audio	<p>High Definition (HD) Audio, Realtek® ALC662 codec</p>			
Speaker	<p>One internal speaker for business audio</p>			
Ethernet	<p>Gigabit ethernet on planar, Marvell® 88E8070, Wake on LAN®, ASF 2.0</p>			
Modem	<p>None</p>			
Security chip	<p>Winbond WPCT200 SafeKeeper™ Trusted Platform Module, TCG 1.2-compliant</p>		<p>Limited Warranty¹</p> <ul style="list-style-type: none"> ↪ 3-year parts and labor ↪ International Warranty Service⁹ ↪ Customer Replaceable Unit (CRU) parts only (with limited onsite service for selected parts³, 8 am - 5 pm, Mon - Fri coverage excluding holidays, next business day response time) ↪ Onsite service upgrade options (in eligible locations):⁷ <ul style="list-style-type: none"> • 3-year LOR 9x5, 4 hour response (ThinkPlus™ part number 41C9192) • 4-year LOR 9x5, 4 hour response (ThinkPlus part number 41C9195) • 4-year LOR 24x7, 4 hour response (ThinkPlus part number 41C9196) ↪ Other ThinkPlus services at lenovo.com/thinkplus/warranty ↪ 24 hour x 7 day¹⁴ toll-free support during the warranty period¹ via 800-426-7378 	
Keyboard	<p>Preferred Pro USB Keyboard (USB connector), 104-key, black, Lenovo logo</p>			
Mouse	<p>Optical Wheel Mouse (USB connector), 400dpi, black, Lenovo logo</p>			
Power supply	<p>280 watts with variable speed fan, autosensing, 80% PSU</p>			
Preloaded operating system²⁰	<p>Accessories</p>			
- <i>Some:</i> Microsoft® Windows® XP Professional with Vista® COA	<p>1GB PC2-5300 CL5 NP DDR2 UDIMM 73P4984</p> <p>2GB PC2-5300 CL5 NP DDR2 UDIMM 73P4985</p>			
- <i>Some:</i> Microsoft Windows Vista Business Edition (32-bit)	<p>1GB PC2-6400 NP DDR2 UDIMM 41U2977</p> <p>2GB PC2-6400 NP DDR2 UDIMM 41U2978</p>			
- <i>Some:</i> Microsoft Windows Vista Business Edition (64-bit)	<p>500GB SATA 3.0Gb/s Disk (7200 rpm) 43R1990</p> <p>USB 2.0 Essential Memory Key 32GB 45K1258</p>			
↪ <i>XP models:</i> Vista Basic logo	<p>USB 2.0 Portable Secure 320GB Hard Disk 43R2019</p> <p>ThinkVision® L2440p Wide 24" Monitor 4420HB2</p>			
↪ <i>Vista models:</i> Vista Premium logo	<p>Wireless Kbd & Opt Wheel Mouse (via USB) 73P4067</p> <p>Kensington Cable Lock from Lenovo 73P2582</p>			
Preloaded applications⁵ (all OSes; only some listed)	<p>ATI Radeon HD 2400 XT 256MB 43R1962</p> <p>ATI Radeon HD 3470 256MB (DP, VGA) 45K1636</p> <p>NVIDIA® GeForce® 9500GT 512MB (DP, DVI) 45K1635</p> <p>Other accessories at lenovo.com/accessories</p>			
• Microsoft Office 2007 Trial (60-day)				
• Sonic RecordNow and Drive Letter Access (DVD±RW)				
• Corel® WinDVD® (DVD, DVD±RW)				

See footnotes for important warranty information

US models announced December 9, 2008; previous models on August 12 or September 9, 2008

© Lenovo (ATHN1-5) December 2008

Name	Type-model	Slot x bay	AMD processor	GHz	Core	Memory ⁸	SATA disk	2nd Disk Bay	SATA optical	Integrated graphics	Monitor connectors	Vista preload	Global (G) GMP (P)	Avail date
A62	7061-A1U	4x4	Athlon X2 5400B	2.8	Dual	2GB	160GB ²	None	DVD±RW	3100	VGA, DVI-D	Bus32	G P	Sep 08

- This model is part of the Global Models Plus (GMP) program with limited onsite service³ 3-year limited warranty

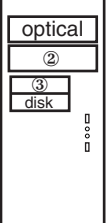
Positioning Processor	Stability and manageability for large enterprise and mid-market AMD® Athlon™ X2 Dual-Core Processor 5400B with dual-core, virtualization technology, integrated DDR2 memory controller, and 1MB dedicated L2 cache		Tower <ul style="list-style-type: none"> • Business black color • 6.9" W X 17.3" D X 15.8" H • 175mm W X 440mm D X 402mm H • 24.2lb (11.0kg) in typical configuration • Handle on top front • Toolless cover removal • Toolless disk, diskette drive, optical drive removal • Toolless adapter retention 																																																					
Implementation	Processor in Socket AM2																																																							
Memory	2GB std, 8GB max⁸, PC2-6400 800MHz DDR2 , non-parity, dual-channel capable, four 240-pin DIMM sockets; <i>Italics:</i> standard memory in two sockets; two sockets available																																																							
Graphics	ATI™ Radeon™ 3100 , integrated graphics in 780V, uses main memory (up to 512MB), one analog VGA DB-15 connector, one DVI-D connector, DirectX® 10, ATI Avivo™, SurroundView™, supports dual independent display; supports up to 4 independent monitors with optional dual-head ATI graphics adapter																																																							
SATA disk	160GB , SATA 3.0Gb/s 7200 rpm, vibration dampening mounts		Bay ① 5.25", 1.6" high, access, std optical Bay ② 5.25", 1.6" high, access, open Bay ③ 3.5", 1" high, access, open (reader/diskette) Bay ④ 3.5", 1" high, no access, std disk Slot 1: half-length, full-height, PCIe 2.0 x1 Slot 2: half-length, full-height, PCIe 2.0 x16 (75w max) Slot 3: half-length, full-height, 32-bit PCI 2.3 Slot 4: half-length, full-height, 32-bit PCI 2.3																																																					
SATA controller	Serial ATA, SATA 3.0Gb/s, integrated in SB700, RAID 0/1 support																																																							
SATA DVD±RW	Super Multi-Burner DL DVD±RW SATA 1.5Gb/s Drive (41N5620)																																																							
SATA cables	Two SATA cables (each 1-drop to device), four SATA connectors																																																							
eSATA port	None																																																							
EIDE controller	None																																																							
Diskette drive	None																																																							
Media reader	None																																																							
Chipset	AMD 780V Chipset with HyperTransport™ 3.0 and PCI Express® 2.0 support; SB700 south bridge for SATA 3.0Gb/s with RAID 0/1 support, ATA-133 EIDE, PCI 2.3, USB, LPC bus / Winbond® W83627DHG Super I/O																																																							
Front ports	Two USB 2.0, microphone (stereo, 3.5mm), headphone (stereo, 3.5mm)																																																							
Rear ports	Six USB 2.0, serial (9-pin), parallel (25-pin), keyboard (PS/2), mouse (PS/2), ethernet (RJ-45), monitor (VGA DB-15, DVI-D)																																																							
Internal connector	Two USB 2.0 planar conn (1 used; one open for media reader or 2 rear USB ports)																																																							
Rear audio ports	Line-in (stereo, 3.5mm), line-out (stereo, 3.5mm), microphone-in (stereo, 3.5mm)																																																							
Audio	High Definition (HD) Audio, Realtek® ALC662 codec																																																							
Speaker	One internal speaker for business audio																																																							
Ethernet	Gigabit ethernet on planar, Marvell® 88E8070, Wake on LAN®, ASF 2.0																																																							
Modem	None																																																							
Security chip	Winbond WPCT200 SafeKeeper™ Trusted Platform Module, TCG 1.2-compliant																																																							
Keyboard	Preferred Pro USB Keyboard (USB connector), 104-key, black, Lenovo logo																																																							
Mouse	Optical Wheel Mouse (USB connector), 400dpi, black, Lenovo logo																																																							
Power supply	280 watts with variable speed fan, manual switch																																																							
Preloaded operating system²⁰	Accessories <table border="0"> <tr><td>1GB PC2-6400 NP DDR2 UDIMM</td><td>41U2977</td></tr> <tr><td>2GB PC2-6400 NP DDR2 UDIMM</td><td>41U2978</td></tr> <tr><td>250GB SATA 3.0Gb/s Disk (7200 rpm)</td><td>41N3015</td></tr> <tr><td>500GB SATA 3.0Gb/s Disk (7200 rpm)</td><td>43R1990</td></tr> <tr><td>USB Portable Diskette Drive</td><td>05K9276</td></tr> <tr><td>USB 2.0 Lenovo Multimedia Headset</td><td>40Y8518</td></tr> <tr><td>USB 2.0 Lenovo Webcam</td><td>40Y8519</td></tr> <tr><td>USB 2.0 Essential Memory Key 32GB</td><td>45K1258</td></tr> <tr><td>USB 2.0 Security Memory Key 2GB</td><td>41U5119</td></tr> <tr><td>USB 2.0 Security Memory Key 4GB</td><td>41U5120</td></tr> <tr><td>USB 2.0 Ultra Secure Memory Key 2GB</td><td>45J5916</td></tr> <tr><td>USB 2.0 Ultra Secure Memory Key 4GB</td><td>45J5917</td></tr> <tr><td>USB 2.0 Ultra Secure Memory Key 8GB</td><td>45J5918</td></tr> <tr><td>USB 2.0 Portable 160GB Hard Disk</td><td>43R1784</td></tr> <tr><td>USB 2.0 Portable Secure 320GB Hard Disk</td><td>43R2019</td></tr> <tr><td>ThinkVision® L1700p 17" Monitor</td><td>9417HE2</td></tr> <tr><td>ThinkVision L1940p Wide 19" Monitor</td><td>4424HB6</td></tr> <tr><td>ThinkVision L2240p Wide 22" Monitor</td><td>4422HB6</td></tr> <tr><td>ThinkVision L2440p Wide 24" Monitor</td><td>4420HB2</td></tr> <tr><td>Wireless Kbd & Opt Wheel Mouse (via USB)</td><td>73P4067</td></tr> <tr><td>Laser Tilt Wheel Mouse (USB, PS/2)</td><td>41U3074</td></tr> <tr><td>Kensington Cable Lock from Lenovo</td><td>73P2582</td></tr> <tr><td>ATI Radeon HD 2400 XT 256MB</td><td>43R1962</td></tr> <tr><td>ATI Radeon HD 3470 256MB (DP, VGA)</td><td>45K1636</td></tr> <tr><td>NVIDIA® GeForce® 9500GT 512MB (DP, DVI)</td><td>45K1635</td></tr> <tr><td>Acc Guide in pdf lenovo.com/accessoriesguide</td><td></td></tr> <tr><td>Other accessories at lenovo.com/accessories</td><td></td></tr> </table>		1GB PC2-6400 NP DDR2 UDIMM	41U2977	2GB PC2-6400 NP DDR2 UDIMM	41U2978	250GB SATA 3.0Gb/s Disk (7200 rpm)	41N3015	500GB SATA 3.0Gb/s Disk (7200 rpm)	43R1990	USB Portable Diskette Drive	05K9276	USB 2.0 Lenovo Multimedia Headset	40Y8518	USB 2.0 Lenovo Webcam	40Y8519	USB 2.0 Essential Memory Key 32GB	45K1258	USB 2.0 Security Memory Key 2GB	41U5119	USB 2.0 Security Memory Key 4GB	41U5120	USB 2.0 Ultra Secure Memory Key 2GB	45J5916	USB 2.0 Ultra Secure Memory Key 4GB	45J5917	USB 2.0 Ultra Secure Memory Key 8GB	45J5918	USB 2.0 Portable 160GB Hard Disk	43R1784	USB 2.0 Portable Secure 320GB Hard Disk	43R2019	ThinkVision® L1700p 17" Monitor	9417HE2	ThinkVision L1940p Wide 19" Monitor	4424HB6	ThinkVision L2240p Wide 22" Monitor	4422HB6	ThinkVision L2440p Wide 24" Monitor	4420HB2	Wireless Kbd & Opt Wheel Mouse (via USB)	73P4067	Laser Tilt Wheel Mouse (USB, PS/2)	41U3074	Kensington Cable Lock from Lenovo	73P2582	ATI Radeon HD 2400 XT 256MB	43R1962	ATI Radeon HD 3470 256MB (DP, VGA)	45K1636	NVIDIA® GeForce® 9500GT 512MB (DP, DVI)	45K1635	Acc Guide in pdf lenovo.com/accessoriesguide		Other accessories at lenovo.com/accessories	
1GB PC2-6400 NP DDR2 UDIMM	41U2977																																																							
2GB PC2-6400 NP DDR2 UDIMM	41U2978																																																							
250GB SATA 3.0Gb/s Disk (7200 rpm)	41N3015																																																							
500GB SATA 3.0Gb/s Disk (7200 rpm)	43R1990																																																							
USB Portable Diskette Drive	05K9276																																																							
USB 2.0 Lenovo Multimedia Headset	40Y8518																																																							
USB 2.0 Lenovo Webcam	40Y8519																																																							
USB 2.0 Essential Memory Key 32GB	45K1258																																																							
USB 2.0 Security Memory Key 2GB	41U5119																																																							
USB 2.0 Security Memory Key 4GB	41U5120																																																							
USB 2.0 Ultra Secure Memory Key 2GB	45J5916																																																							
USB 2.0 Ultra Secure Memory Key 4GB	45J5917																																																							
USB 2.0 Ultra Secure Memory Key 8GB	45J5918																																																							
USB 2.0 Portable 160GB Hard Disk	43R1784																																																							
USB 2.0 Portable Secure 320GB Hard Disk	43R2019																																																							
ThinkVision® L1700p 17" Monitor	9417HE2																																																							
ThinkVision L1940p Wide 19" Monitor	4424HB6																																																							
ThinkVision L2240p Wide 22" Monitor	4422HB6																																																							
ThinkVision L2440p Wide 24" Monitor	4420HB2																																																							
Wireless Kbd & Opt Wheel Mouse (via USB)	73P4067																																																							
Laser Tilt Wheel Mouse (USB, PS/2)	41U3074																																																							
Kensington Cable Lock from Lenovo	73P2582																																																							
ATI Radeon HD 2400 XT 256MB	43R1962																																																							
ATI Radeon HD 3470 256MB (DP, VGA)	45K1636																																																							
NVIDIA® GeForce® 9500GT 512MB (DP, DVI)	45K1635																																																							
Acc Guide in pdf lenovo.com/accessoriesguide																																																								
Other accessories at lenovo.com/accessories																																																								
- Microsoft® Windows® Vista® Business Edition (32-bit)																																																								
◆ Vista Premium logo																																																								
Preloaded applications⁵																																																								
• Rescue and Recovery™																																																								
• Client Security Solution™																																																								
• ThinkVantage Productivity Center																																																								
• ThinkVantage System Update																																																								
• Norton Internet Security™ (90 days of virus definitions)																																																								
• Diskeeper® Home																																																								
• PC-Doctor™ (diagnostics)																																																								
• Adobe® Reader																																																								
• Windows Live™ Toolbar																																																								
• Windows Live Search																																																								
• Picasa from Google																																																								
• Microsoft Office 2007 Trial (60-day)																																																								
• Sonic RecordNow and Drive Letter Access (DVD±RW)																																																								
• Corel® WinDVD® (DVD±RW)																																																								
	Supports ThinkVantage® technologies																																																							
	GREENGUARD® certified ROHS-compliant																																																							
	Limited Warranty¹ <ul style="list-style-type: none"> ↪ 3-year parts and labor ↪ International Warranty Service⁹ ↪ Customer Replaceable Unit (CRU) parts only (with limited onsite service for selected parts³, 8 am - 5 pm, Mon - Fri coverage excluding holidays, next business day response time) ↪ Onsite service upgrade options (in eligible locations):⁷ <ul style="list-style-type: none"> • 4-year LOR 9x5, Next Business Day (ThinkPlus™ part number 41C9194) • 4-year LOR 9x5, 4 hour response (ThinkPlus part number 41C9195) • 4-year LOR 24x7, 4 hour response (ThinkPlus part number 41C9196) ↪ ThinkPlus services at lenovo.com/thinkplus/warranty ↪ Post warranty maintenance services available ↪ 24 hour x 7 day¹⁴ toll-free support during the warranty period¹ via 800-426-7378 																																																							

See footnotes for important warranty information
US model announced August 12, 2008

ThinkCentre® A62 Tower (3656) - ENERGY STAR® 4.0 (GMP)

Personal Systems Reference (PSREF)

Name	Type-model	Slot x bay	AMD processor	GHz	Core	Memory ⁸	SATA disk	2nd Disk Bay	SATA optical	Integrated graphics	Monitor connectors	ENERGY STAR 4.0	Vista preload	Global (G) GMP (P)	Avail date
A62	3656-AAU	4x4	Athlon X2 5400B	2.8	Dual	2GB	160GB ²	None	DVD±RW	3100	VGA, DVI-D	ES40	Bus32	G P	Jan 09

- This model is part of the Global Models Plus (GMP) program with limited onsite service³ 3-year limited warranty

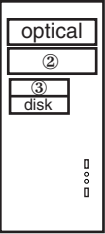
Positioning Processor	Stability and manageability for large enterprise and mid-market AMD® Athlon™ X2 Dual-Core Processor 5400B with dual-core, virtualization technology, integrated DDR2 memory controller, and 1MB dedicated L2 cache Processor in Socket AM2										Tower <ul style="list-style-type: none"> • Business black color • 6.9" W X 17.3" D X 15.8" H • 175mm W X 440mm D X 402mm H • 24.2lb (11.0kg) in typical configuration • Handle on top front • Toolless cover removal • Toolless disk, diskette drive, optical drive removal • Toolless adapter retention 	
Implementation	2GB std, 8GB max⁸, PC2-6400 800MHz DDR2, non-parity, dual-channel capable, four 240-pin DIMM sockets; <i>Italics:</i> standard memory in two sockets; two sockets available										Bay ① 5.25", 1.6" high, access, std optical Bay ② 5.25", 1.6" high, access, open Bay ③ 3.5", 1" high, access, open (reader/diskette) Bay ④ 3.5", 1" high, no access, std disk	
Memory	ATI™ Radeon™ 3100, integrated graphics in 780V, uses main memory (up to 512MB), one analog VGA DB-15 connector, one DVI-D connector, DirectX® 10, ATI Avivo™, SurroundView™, supports dual independent display; supports up to 4 independent monitors with optional dual-head ATI graphics adapter										Slot 1: half-length, full-height, PCIe 2.0 x1 Slot 2: half-length, full-height, PCIe 2.0 x16 (75w max) Slot 3: half-length, full-height, 32-bit PCI 2.3 Slot 4: half-length, full-height, 32-bit PCI 2.3	
Graphics	160GB, SATA 3.0Gb/s 7200 rpm, vibration dampening mounts SATA controller Serial ATA, SATA 3.0Gb/s, integrated in SB700, RAID 0/1 support SATA DVD±RW Super Multi-Burner DL DVD±RW SATA 1.5Gb/s Drive (41N5620) SATA cables Two SATA cables (each 1-drop to device), four SATA connectors eSATA port None EIDE controller None Diskette drive None Media reader None											
Chipset	AMD 780V Chipset with HyperTransport™ 3.0 and PCI Express 2.0 support; SB700 south bridge for SATA 3.0Gb/s with RAID 0/1 support, ATA-133 EIDE, PCI 2.3, USB, LPC bus / Winbond® W83627DHG Super I/O											
Front ports	Two USB 2.0, microphone (stereo, 3.5mm), headphone (stereo, 3.5mm)											
Rear ports	Six USB 2.0, serial (9-pin), parallel (25-pin), keyboard (PS/2), mouse (PS/2), ethernet (RJ-45), monitor (VGA DB-15, DVI-D)											
Internal connector	Two USB 2.0 planar conn (1 used; one open for media reader or 2 rear USB ports)											
Rear audio ports	Line-in (stereo, 3.5mm), line-out (stereo, 3.5mm), microphone-in (stereo, 3.5mm)											
Audio	High Definition (HD) Audio, Realtek® ALC662 codec											
Speaker	One internal speaker for business audio											
Ethernet	Gigabit ethernet on planar, Marvel® 88E8070, Wake on LAN®, ASF 2.0											
Modem	None											
Security chip	Winbond WPCT200 SafeKeeper™ Trusted Platform Module, TCG 1.2-compliant											
Keyboard	Preferred Pro USB Keyboard (USB connector), 104-key, black, Lenovo logo											
Mouse	Optical Wheel Mouse (USB connector), 400dpi, black, Lenovo logo											
Power supply	280 watts with variable speed fan, autosensing, 80% PSU											
Preloaded operating system²⁰	- Microsoft® Windows® Vista® Business Edition (32-bit) ↕ Vista Premium logo											
Preloaded applications⁵	<ul style="list-style-type: none"> • Rescue and Recovery™ • Client Security Solution™ • ThinkVantage Productivity Center • ThinkVantage System Update • Norton Internet Security™ (90 days of virus definitions) • Diskeeper® Home • PC-Doctor™ (diagnostics) • Adobe® Reader • Windows Live™ Toolbar • Windows Live Search • Picasa from Google • Microsoft Office 2007 Trial (60-day) • Sonic RecordNow and Drive Letter Access (DVD±RW) • Corel® WinDVD® (DVD±RW) 											
Accessories	1GB PC2-6400 NP DDR2 UDIMM 41U2977 2GB PC2-6400 NP DDR2 UDIMM 41U2978 250GB SATA 3.0Gb/s Disk (7200 rpm) 41N3015 500GB SATA 3.0Gb/s Disk (7200 rpm) 43R1990 USB Portable Diskette Drive 05K9276 USB 2.0 Lenovo Multimedia Headset 40Y8518 USB 2.0 Lenovo Webcam 40Y8519 USB 2.0 Essential Memory Key 32GB 45K1258 USB 2.0 Security Memory Key 2GB 41U5119 USB 2.0 Security Memory Key 4GB 41U5120 USB 2.0 Ultra Secure Memory Key 2GB 45J5916 USB 2.0 Ultra Secure Memory Key 4GB 45J5917 USB 2.0 Ultra Secure Memory Key 8GB 45J5918 USB 2.0 Portable 160GB Hard Disk 43R1784 USB 2.0 Portable Secure 320GB Hard Disk 43R2019 ThinkVision® L1700p 17" Monitor 9417HE2 ThinkVision L1940p Wide 19" Monitor 4424HB6 ThinkVision L2240p Wide 22" Monitor 4422HB6 ThinkVision L2440p Wide 24" Monitor 4420HB2 Wireless Kbd & Opt Wheel Mouse (via USB) 73P4067 Laser Tilt Wheel Mouse (USB, PS/2) 41U3074 Kensington Cable Lock from Lenovo 73P2582 ATI Radeon HD 2400 XT 256MB 43R1962 ATI Radeon HD 3470 256MB (DP, VGA) 45K1636 NVIDIA® GeForce® 9500GT 512MB (DP, DVI) 45K1635 Acc Guide in pdf lenovo.com/accessoriesguide Other accessories at lenovo.com/accessories											
	Supports ThinkVantage® technologies											
	EPEAT™ Gold rating ENERGY STAR 4.0-compliant GREENGUARD® certified RoHS-compliant											
	Limited Warranty¹ <ul style="list-style-type: none"> ↔ 3-year parts and labor ↔ International Warranty Service⁹ ↔ Customer Replaceable Unit (CRU) parts only (with limited onsite service for selected parts³, 8 am - 5 pm, Mon - Fri coverage excluding holidays, next business day response time) ↔ Onsite service upgrade options (in eligible locations):⁷ <ul style="list-style-type: none"> • 4-year LOR 9x5, Next Business Day (ThinkPlus™ part number 41C9194) • 4-year LOR 9x5, 4 hour response (ThinkPlus part number 41C9195) • 4-year LOR 24x7, 4 hour response (ThinkPlus part number 41C9196) ↔ ThinkPlus services at lenovo.com/thinkplus/warranty ↔ Post warranty maintenance services available ↔ 24 hour x 7 day¹⁴ toll-free support during the warranty period¹ via 800-426-7378 											

See footnotes for important warranty information
 US model announced December 9, 2008

Partial list of accessories supported on ThinkCentre A62

Memory

512MB PC2-5300 CL5 NP DDR2 UDIMM ⁴⁰	73P4983	ann 06/28/05
1GB PC2-5300 CL5 NP DDR2 UDIMM ⁴⁰	73P4984	ann 06/28/05
2GB PC2-5300 CL5 NP DDR2 UDIMM ⁴⁰	73P4985	ann 09/26/06
512MB PC2-6400 NP DDR2 UDIMM	41U2976	ann 09/26/06
1GB PC2-6400 NP DDR2 UDIMM	41U2977	ann 09/26/06
2GB PC2-6400 NP DDR2 UDIMM	41U2978	ann 01/08/08

⁴⁰ When PC2-5300 is installed with systems that have PC2-6400 memory, PC2-6400 will operate at the PC2-5300 memory speed.

Optical

DVD-ROM DL SATA 1.5Gb/s 16X-48X Max ⁴	41N5618	ann 09/26/06
Super Multi-Burner DL DVD±RW SATA Drive	41N5620	ann 09/26/06

Storage and removable storage

80GB SATA 3.0Gb/s Disk (7200 rpm)	09N4253	ann 05/19/03
160GB SATA 3.0Gb/s Disk (7200 rpm)	09N4254	ann 05/19/03
250GB SATA 3.0Gb/s Disk (7200 rpm)	41N3015	ann 01/24/06
500GB SATA 3.0Gb/s Disk (7200 rpm)	43R1990	ann 11/06/07
USB Portable Diskette Drive	05K9276	ann 06/05/00
USB 2.0 Essential Memory Key 1GB	41U4940	ann 01/23/07
USB 2.0 Essential Memory Key 2GB	41U4944	ann 01/23/07
USB 2.0 Essential Memory Key 4GB	45J7904	ann 06/24/08
USB 2.0 Essential Memory Key 8GB	45J7905	ann 07/15/08
USB 2.0 Essential Memory Key 32GB	45K1258	ann 10/28/08
USB 2.0 Security Memory Key 1GB	41U5118	ann 07/17/07
USB 2.0 Security Memory Key 2GB	41U5119	ann 07/17/07
USB 2.0 Security Memory Key 4GB	41U5120	ann 07/17/07
USB 2.0 Ultra Secure Memory Key 1GB	45J5915	ann 08/26/08
USB 2.0 Ultra Secure Memory Key 2GB	45J5916	ann 08/26/08
USB 2.0 Ultra Secure Memory Key 4GB	45J5917	ann 08/26/08
USB 2.0 Ultra Secure Memory Key 8GB	45J5918	ann 08/26/08
USB 2.0 Portable 160GB Hard Disk	43R1784	ann 09/23/08
USB 2.0 Portable Secure 160GB Hard Disk	43R2018	ann 11/18/08
USB 2.0 Portable Secure 320GB Hard Disk	43R2019	ann 11/18/08
USB 2.0 CD-RW/DVD-ROM Combo II Drive	40Y8637	ann 01/05/06
USB 2.0 Super Multi-Burner Drive	41N5565	ann 01/23/07

Graphics

Desktop 9486/7057/7062/3658 support Low Profile 35 watts max:

ATI™ Radeon™ HD 2400 XT 256MB	43R1962	ann 11/06/07
ATI Radeon HD 3470 256MB (DP, VGA)	45K1636	ann 11/18/08

Tower 9705/9935/9485/9625/7061/3656 support 75 watts max:

ATI Radeon HD 2400 XT 256MB	43R1962	ann 11/06/07
ATI Radeon HD 3470 256MB (DP, VGA)	45K1636	ann 11/18/08
NVIDIA® GeForce® 9500 GT 512MB (DP, DVI)	45K1635	ann 11/18/08

More information at www.lenovo.com/support/graphiccards

Keyboard

Preferred Pro USB Keyboard	73P5220	ann 06/21/05
Preferred Pro Full Size PS/2 Keyboard	31P7415	ann 06/04/02
Enhanced Performance USB Keyboard	73P2620	ann 03/23/04
Wireless Kbd & Opt Wheel Mouse (via USB)	73P4067	ann 12/07/04
Lenovo USB Fingerprint Keyboard	73P4730	ann 02/22/05

More information at www.lenovo.com/support/keyboards

Mouse

Optical Wheel Mouse (USB)	06P4069	ann 05/21/03
Optical ScrollPoint® Mouse (USB, PS/2)	31P7405	ann 08/27/02
Laser Tilt Wheel Mouse (USB, PS/2)	41U3074	ann 01/23/07
Lenovo Wireless Laser Mouse (blk, via USB)	45K1696	ann 11/25/08
Lenovo Wireless Laser Mouse (red, via USB)	51J0198	ann 11/25/08

More information at www.lenovo.com/support/mice

Multimedia

USB 2.0 Lenovo Multimedia Headset	40Y8518	ann 06/27/06
USB 2.0 Lenovo Webcam	40Y8519	ann 08/29/06

Security

Kensington® Cable Lock from Lenovo	73P2582	ann 12/29/03
Kensington Twin Head Cable Lock	45K1620	ann 09/30/08
USB Gemplus GemPC Smart Card Reader	41N3040	ann 02/21/06

Monitors

ThinkVision® L174 17" Monitor	9227AE1	ann 04/15/08
ThinkVision L1700p 17" Monitor	9417HE2	ann 09/17/08
ThinkVision L1900p 19" Monitor	4431HE1	ann 11/11/08
ThinkVision L1940p Wide 19" Monitor	4424HB6	ann 09/17/08
ThinkVision L200p Wide 20.1" Monitor	4438HB6	ann 04/15/08
ThinkVision L2240p Wide 22" Monitor	4422HB6	ann 09/17/08
ThinkVision L2440p Wide 24" Monitor	4420HB2	ann 09/17/08
ThinkVision L2440x Wide 24" Monitor	4421HB2	ann 09/17/08

More information at www.lenovo.com/thinkvision

Monitor Accessories⁴⁶

ThinkVision USB Soundbar	40Y7616	ann 08/23/05
ThinkVision Soundbar (L1900p, 24" Wide)	45K1263	ann 09/16/08
Kensington Cable Lock from Lenovo	73P2582	ann 12/29/03
Kensington Twin Head Cable Lock	45K1620	ann 09/30/08
Radiant Arm	19K4464	ann 05/05/00

⁴⁶ Compatible on selected Lenovo and ThinkVision monitors.

More information at www.lenovo.com/support/monitoraccessories

Medialess License Key (MLK)

Microsoft® Office 2007 Basic, English	43R1528	ann 01/31/07
Microsoft Office 2007 Small Business, Engl	43R1534	ann 01/31/07
Microsoft Office 2007 Professional, English	43R1531	ann 01/31/07

Other accessories at www.lenovo.com/accessories

Accessories Guide pdf at www.lenovo.com/accessoriesguide

Partial list of Lenovo® ThinkPlus Services⁷ for ThinkCentre desktops

For more information see:

http://www.lenovo.com/services_warranty/us/en/index.html

<p>ThinkPlus service upgrade options</p> <p>ThinkCentre desktop with 1-year Onsite warranty <i>LOR = Lenovo Onsite Repair</i></p> <table border="0"> <tr> <td>1-year LOR 9x5 4-hour response</td> <td>41C9189</td> </tr> <tr> <td>2-year LOR 9x5 Next Business Day</td> <td>41C9187</td> </tr> <tr> <td>2-year LOR 9x5 4-hour response</td> <td>41C9190</td> </tr> <tr> <td>3-year LOR 9x5 Next Business Day</td> <td>41C9188</td> </tr> <tr> <td>3-year LOR 9x5 4-hour response</td> <td>41C9191</td> </tr> </table> <p>ThinkCentre desktop with 3-year Onsite warranty <i>LOR = Lenovo Onsite Repair</i></p> <table border="0"> <tr> <td>3-year LOR 9x5 4-hour response</td> <td>41C9192</td> </tr> <tr> <td>3-year LOR 24x7 4-hour response</td> <td>41C9193</td> </tr> <tr> <td>4-year LOR 9x5 Next Business Day</td> <td>41C9194</td> </tr> <tr> <td>4-year LOR 9x5 4-hour response</td> <td>41C9195</td> </tr> <tr> <td>4-year LOR 24x7 4-hour response</td> <td>41C9196</td> </tr> </table>	1-year LOR 9x5 4-hour response	41C9189	2-year LOR 9x5 Next Business Day	41C9187	2-year LOR 9x5 4-hour response	41C9190	3-year LOR 9x5 Next Business Day	41C9188	3-year LOR 9x5 4-hour response	41C9191	3-year LOR 9x5 4-hour response	41C9192	3-year LOR 24x7 4-hour response	41C9193	4-year LOR 9x5 Next Business Day	41C9194	4-year LOR 9x5 4-hour response	41C9195	4-year LOR 24x7 4-hour response	41C9196	<p>ThinkPlus Priority Support for enterprise customers</p> <ul style="list-style-type: none"> • 9x5 next-business-day response Lenovo Onsite Repair • 24x7 support with priority routing and advanced level technicians <p>ThinkCentre desktop with 1-year Onsite warranty</p> <table border="0"> <tr> <td>3-year Priority Support</td> <td>45J9087</td> </tr> </table> <p>ThinkCentre desktop with 3-year Onsite warranty</p> <table border="0"> <tr> <td>3-year Priority Support</td> <td>45J9088</td> </tr> <tr> <td>4-year Priority Support</td> <td>45J9089</td> </tr> <tr> <td>5-year Priority Support</td> <td>45J9090</td> </tr> <tr> <td>3-year Priority Support 4-hour response</td> <td>45J9091</td> </tr> <tr> <td>4-year Priority Support 4-hour response</td> <td>45J9092</td> </tr> <tr> <td>5-year Priority Support 4-hour response</td> <td>45J9093</td> </tr> </table>	3-year Priority Support	45J9087	3-year Priority Support	45J9088	4-year Priority Support	45J9089	5-year Priority Support	45J9090	3-year Priority Support 4-hour response	45J9091	4-year Priority Support 4-hour response	45J9092	5-year Priority Support 4-hour response	45J9093
1-year LOR 9x5 4-hour response	41C9189																																		
2-year LOR 9x5 Next Business Day	41C9187																																		
2-year LOR 9x5 4-hour response	41C9190																																		
3-year LOR 9x5 Next Business Day	41C9188																																		
3-year LOR 9x5 4-hour response	41C9191																																		
3-year LOR 9x5 4-hour response	41C9192																																		
3-year LOR 24x7 4-hour response	41C9193																																		
4-year LOR 9x5 Next Business Day	41C9194																																		
4-year LOR 9x5 4-hour response	41C9195																																		
4-year LOR 24x7 4-hour response	41C9196																																		
3-year Priority Support	45J9087																																		
3-year Priority Support	45J9088																																		
4-year Priority Support	45J9089																																		
5-year Priority Support	45J9090																																		
3-year Priority Support 4-hour response	45J9091																																		
4-year Priority Support 4-hour response	45J9092																																		
5-year Priority Support 4-hour response	45J9093																																		
<p>ThinkPlus Secure Business</p> <p>Lenovo Online Data Backup</p> <ul style="list-style-type: none"> • Secure offsite data storage • 256-bit Advanced Encryption System • Data recovery or access in case of an unforeseen event • Automatic, remote management • Choose which business critical data to back up <table border="0"> <tr> <td>1-year Lenovo Online Data Backup - <i>50GB</i></td> <td>45K5849</td> </tr> <tr> <td>1-year Lenovo Online Data Backup - <i>Unlimited</i></td> <td>45K5870</td> </tr> </table>	1-year Lenovo Online Data Backup - <i>50GB</i>	45K5849	1-year Lenovo Online Data Backup - <i>Unlimited</i>	45K5870																															
1-year Lenovo Online Data Backup - <i>50GB</i>	45K5849																																		
1-year Lenovo Online Data Backup - <i>Unlimited</i>	45K5870																																		

- Availability:** All offers subject to availability. Lenovo reserves the right to alter product offerings and specifications at any time, without notice. Lenovo is not responsible for photographic or typographic errors.
- Warranty:** For a copy of applicable product warranties, write to: Warranty Information, P.O. Box 12195, RTP, NC, 27709, Attn: Dept ZPYA/B676. Lenovo makes no representation or warranty regarding third party products or services.
- ¹ **Limited warranty:** Support unrelated to a warranty issue may be subject to additional charges.
 - ² **Hard drive:** GB = billion bytes, TB = trillion bytes. Accessible capacity is less; up to 4GB is service partition.
 - ³ **Limited onsite service systems** are designed to be repaired during the applicable warranty period primarily with customer-replaceable parts provided by Lenovo. Lenovo will only send a technician onsite to perform a repair if (a) remote telephone diagnosis and/or customer part replacement are unable to resolve the problem, or (b) the part is one of the few designated by Lenovo for onsite replacement. For a list of onsite replaceable parts, contact Lenovo. In the United States call 1-800-426-7378. Support unrelated to a warranty issue may be subject to additional charges. Lenovo onsite repair (LOR), 8 am to 5 pm, Monday through Friday coverage excluding holidays, next business day (NBD) response time.
 - ⁴ **CD and DVD list** maximum rates; rates are variable and are often less than the maximum.
 - ⁵ **Included software** may differ from its retail version (if available), and may not include user manuals or all program functionality. License agreements may apply.
 - ⁶ **Multi-Burner Plus** (part number 73P3305 or 73P3370) is a DVD±RW device that reads and writes to DVD-RAM, DVD-R, DVD-RW, DVD+R, and DVD+RW. It also reads and writes to CD-R and CD-RW media. 73P3370 also writes to DVD+R double layer media.
 - ⁷ **ThinkPlus Services:** These services are available for machines normally used for business, professional, or trade purposes, rather than personal, family, or household purposes. Not all machine types and models are covered. Service period begins with the equipment date of purchase. Service must be purchased during the original limited product warranty period. Service levels are response time objectives and are not guarantees. If the machine problem turns out to be a Customer Replaceable Unit (CRU), a part will be express shipped to you for quick replacement. Onsite 24x7x2-hour service is not available in all locations. P&L means parts and labor. P/U means pick-up. See ThinkPlus terms and conditions for complete details and restrictions.
 - ⁸ **Memory:** For PCs without a separate graphics card, memory supports both system and video. Accessible system memory may be up to 384MB less than the amount stated, depending on video mode.
 - ⁹ **International Warranty Service** is available in any country in which this product is sold and serviced. Service delivery methods and parts availability vary by country, may be different from that in the country of purchase, and are subject to change without notice. Fees and restrictions may apply in some countries.
 - ¹⁰ **Modem speeds:** Public network download speeds are limited to 53Kbps. Upload speeds are limited to 48Kbps for V.92 modems. Actual speeds depend on many factors and are often less than the maximum possible. V.92 functions and speeds require compatible phone line and server equipment. Check with your telephone and ISP service providers for availability.
 - ¹¹ **For combination drives**, maximum speeds only are given in the following order: CD read, CD write, CD re-write, DVD read.
 - ¹⁴ **Response times may vary.** May exclude some holidays. Telephone support may be subject to additional charges.
 - ¹⁵ **Update Connector** is available at no charge to registered customers during the limited warranty period. Line charges may apply.
 - ¹⁶ **Embedded Security Subsystem** works with optional VPN software.

- ¹⁸ **Embedded Security Subsystem** may require download of client security software from the Web.
- ¹⁹ **Asset ID** allows system-specific information to be stored in a chip inside the system; it does not have any radio frequency support.
- ²⁰ **Operating System:** Level of support varies by operating system. Operating systems not preloaded on the system may not provide full feature functionality. Refer to lenovo.com/pc/support and enter your machine type and model number for more information.

This publication was developed for products and services offered in the United States. Lenovo may not offer the products, services or features discussed in this document in other countries. Lenovo may withdraw an offering at any time. Information is subject to change without notice. Consult your local representative for information on offerings available in your area.

Lenovo reserves the right to change specifications and other product information at any time without prior notice. Lenovo is not responsible for photographic or typographical errors. LENOVO PROVIDES THIS PUBLICATION "AS IS" WITHOUT WARRANTY OF ANY KIND, EITHER EXPRESS OR IMPLIED, INCLUDING THE IMPLIED WARRANTIES OF MERCHANTABILITY OR FITNESS FOR A PARTICULAR PURPOSE. Some jurisdictions do not allow disclaimer of express or implied warranties in certain transactions; therefore this disclaimer may not apply to you.

ThinkCentre®

Trademarks: Lenovo, the Lenovo logo, New World. New Thinking., Access Connections, Rescue and Recovery, ThinkCentre, ThinkPad, ThinkVantage, and ThinkVision are trademarks of Lenovo. Microsoft, Windows, and Vista are registered trademarks of Microsoft Corporation. Intel, the Intel logo, Intel Inside logo, Intel Core and Core Inside are trademarks of Intel Corporation in the US and other countries. Other company, product, or service names may be trademarks or service marks of others.

Visit lenovo.com/safecomputing periodically for the latest information on safe and effective computing.

© Lenovo, 2009.
All rights reserved.

Lenovo
1009 Think Place
Morrisville, NC 27560
U.S.A.

January 2009
tcbook.pdf

ThinkStation

Personal Systems Reference Lenovo ThinkStation Workstations

December 2008 - Version 349



ThinkStation S10 (left)
ThinkStation D10 (right)

lenovo.com

ThinkStation



Lenovo ThinkStation S10



Lenovo ThinkStation S10 (left)
Lenovo ThinkStation D10 (right)



Lenovo ThinkStation S10



Lenovo ThinkStation S10



Lenovo ThinkStation S10



Lenovo ThinkStation S10
with Lenovo ThinkVision Monitor

Name	Type-model	Slot x bay	Processor	GHz	Cores	Mem-ory	Disk(s)	RAID	SATA optical	Graphics adapter(s)	1394 adptry	Sound adptry	ENERGY STAR 4.0	Vista preload	Workhorse Global	Avail date
S10	6423-26U	5x6	E6750	2.66	2	2GB	1 x 250GB ² SATA		DVD±RW	1 x FX370	1394		ES40	Bus64	No	Jan 08
S10	6423-27U	5x6	E6850	3.00	2	2GB	2 x 250GB SATA		DVD±RW	1 x FX1700			ES40	Bus64	No	Jan 08
S10	6423-28U	5x6	E6850	3.00	2	2GB	1 x 146GB SAS		DVD±RW	1 x FX1700			ES40	Bus64	No	Jan 08
S10	6423-29U	5x6	E6850	3.00	2	2GB	2 x 250GB SATA		DVD±RW	1 x FX1700	1394	X-Fi	ES40	Bus64	No	Jan 08
S10	6423-31U	5x6	Q6600	2.40	4	2GB	2 x 250GB SATA		DVD±RW	1 x FX1700	1394	X-Fi	ES40	Bus64	No	Jan 08
S10	6423-32U	5x6	Q6700	2.66	4	2GB	2 x 160GB SATA	1	DVD±RW	2 x NVS290			ES40	Bus64	No	Jan 08

- High performance workstation with premium graphics for specialized professionals
- Environmentally friendly, cool, and quiet with rock solid engineering
- These small and medium business (SMB) models are part of the US TopSeller™ Program

Processor	Intel® Core™ 2 Duo Processor E6750 or E6850 with dual-core, 1333MHz system bus, and 4MB L2 cache or Intel Core 2 Quad Processor Q6600 or Q6700 with quad-core, 1066MHz system bus, and 8MB L2 cache Processor uses FC-LGA6 package, one LGA775 socket		Tower <ul style="list-style-type: none"> • Raven black color; metal case • 6.9"W x 19.0"D x 16.8"H (without handle) • 175mm W x 483mm D x 426mm H • 36 lb (16.4kg) max configuration • 31-liter • Removable handle on top front • Toolless side cover removal • Toolless disk and optical drive removal • Toolless adapter retention • Illuminated front icons • Rack shelf support 	
Implementation	2GB std, 8GB max, PC3-8500 1066MHZ DDR3, ECC, dual-channel capable, four 240-pin DIMM sockets; <i>Non-italics:</i> standard memory in two sockets; two sockets available			
Memory	Two PCI Express® x16 adapters required for quad monitor support, * 76 to 150W adapters use auxiliary power connector from PSU <i>Some:</i> NVIDIA® Quadro® NVS 290, PCIe x16 adapter, 256MB, two single-link DVI via DMS-59 with dual DVI-I dongle, 21W <i>Some:</i> NVIDIA Quadro FX 370, PCIe x16 adapter, 256MB, one single-link and 1 dual-link DVI, dual DVI-I or dual VGA, 25W <i>Some:</i> NVIDIA Quadro FX 1700, PCIe x16 adapter, 512MB, two dual-link DVI, dual DVI-I or dual VGA, HDTV out, 42W		Bay ① 5.25", 1.6" high, external, std optical Bay ② 5.25", 1.6" high, external, open Bay ③ 3.5", 1" high, external, std media reader Bay ④ 3.5", 1" high, internal, std disk Bay ⑤ 3.5", 1" high, internal, std or opt disk Bay ⑥ 3.5", 1" high, internal, std or opt disk	
Media reader	9-in-1 media reader, internal USB 2.0		Slot 1: full-length, full-height, PCIe 2.0 x16 (75W* max)	
SATA disk(s)	<i>Some:</i> 160GB or 250GB, SATA 3.0Gb/s, 7200 rpm		Slot 2: full-length, full-height, PCIe 2.0 x16 (75W* max)	
SATA controller	Serial ATA, SATA 3.0Gb/s, integrated in ICH9R		Slot 3: full-length, full-height, 32-bit PCI 2.3	
SATA connectors	Six SATA connectors on planar		Slot 4: full-length, full-height, PCIe x4 (x16 mechanical)	
SATA DVD±RW	Super Multi-Burner DL DVD±RW SATA 1.5Gb/s Drive (41N5620)		Slot 5: half-length, full-height, 32-bit PCI 2.3	
SAS disk	<i>Some:</i> 146GB, Serial Attached SCSI, 3.0Gb/s, 15000 rpm			
SAS controller	<i>Some:</i> LSI™ LSI SAS3041E-R PCIe x4 adapter, 4-port, 3.0Gb/s, RAID® 0, 1, 1E			
Chipset	Intel X38 Express Chipset, Intel I/O Controller Hub 9 RAID (ICH9R) for RAID 0, 1, 5 support, SMSC® SCH5027D Super I/O			
Front ports	Two USB 2.0, microphone (3.5mm), headphone (3.5mm), FireWire 400 (IEEE 1394)		SECURITY <ul style="list-style-type: none"> • Security chip (see information on left) • Side cover lock (ships with two identical keys) • Padlock loop (in rear for opt padlock; padlock prohibits side cover removal) • Security slot (in rear for optional Kensington® Microsaver® cable; prohibits side cover removal) • Chassis intrusion switch • Power-on password • Administrator password • Boot sequence control • Boot without keyboard, mouse, diskette • Serial port I/O control • USB port disablement (front or all) 	
Rear ports	Eight USB 2.0, serial (9-pin), keyboard (PS/2), mouse (PS/2), two ethernet (RJ-45), five analog audio ports (line-in, microphone-in, front-out, rear-out, center/sub-out), optical S/PDIF digital out <i>Some:</i> FireWire PCI adapter, 1394a-2000, 400Mbps, two 6-pin ports on rear High Definition (HD) Audio, Analog Devices AD1988A codec; <i>Some:</i> Creative Sound Blaster® X-Fi, PCI adapter, high-end sound adapter			
IEEE 1394 adptry	Internal speaker for business audio		Supports ThinkVantage® technologies RoHS-compliant ENERGY STAR® 4.0-compliant	
Audio	Dual gigabit ethernet on planar, Broadcom® BCM5754 and BCM5755, 2 x PCIe x1			
Speaker	Integrated in ethernet controller BCM5755, TCG 1.2-compliant		LIMITED WARRANTY¹ <ul style="list-style-type: none"> ↔ 3-year parts and labor ↔ Customer Replaceable Unit (CRU) parts only (with limited onsite service for selected parts³, 8 am - 5 pm, Mon - Fri coverage excluding holidays, next business day response time) ↔ ThinkPlus™ services available; see http://lenovo.com/thinkplus/warranty • Onsite service upgrade options (in eligible locations)⁷ • Post warranty maintenance services ↔ 24 hour x 7 day¹⁴ toll-free support during the warranty period¹ via 800-426-7378 	
Ethernet	Preferred Pro USB Keyboard (USB connector), 104-key, black			
Security chip	Optical Wheel Mouse (USB connector), black			
Keyboard	650 watts with 120mm bottom-mounted variable speed fan, universal, 80 PLUS®			
Mouse	3 to 5 fans (power supply, CPU, rear, opt front PCI [>75W graphics], opt front [SAS])			
Power supply	Rack shelf support			
Cooling				
Rack mount				
Preloaded operating system²⁰ - Microsoft® Windows® Vista® Business Edition (64-bit) ♦ Vista Premium logo Preloaded applications⁵ <ul style="list-style-type: none"> • Rescue and Recovery™ • Client Security Solution™ • ThinkVantage Productivity Center • ThinkVantage System Update • System Migration Assistant • Norton Internet Security™ (90 days of virus definitions) • PC-Doctor™ (diagnostics) • Adobe® Reader • Microsoft Office 2007 Trial (60-day) • Sonic RecordNow and Drive Letter Access (DVD±RW) • Corel® WinDVD® (DVD±RW) 			Accessories <ul style="list-style-type: none"> 1GB PC3-8500 DDR3 ECC UDIMM 41U5251 2GB PC3-8500 DDR3 ECC UDIMM 41U5252 500GB SATA 3.0Gb/s Disk (7200 rpm) 43R1990 750GB SATA 3.0Gb/s Disk (7200 rpm) 43R1991 1TB SATA 3.0Gb/s Disk (7200 rpm) 45J7918 Super Multi-Burner DL DVD±RW SATA 1.5Gb/s 41N5620 Blu-ray Burner/HD-DVD Player SATA 1.5Gb/s 43R1958 USB 2.0 Lenovo Multimedia Headset 40Y8518 USB 2.0 Webcam 40Y8519 USB 2.0 Ultra Secure Memory Key 8GB 45J5918 USB 2.0 Portable Secure 320GB Hard Disk 43R2019 ThinkVision® L1700p 17" Monitor 9417HE2 ThinkVision L1940p Wide 19" Monitor 4424HB6 ThinkVision L2240p Wide 22" Monitor 4422HB6 ThinkVision L2440x Wide 24" Monitor 4421HB2 Wireless Kbd & Opt Wheel Mouse (via USB) 73P4067 Laser Tilt Wheel Mouse (USB, PS/2) 41U3074 Kensington® Cable Lock from Lenovo 73P2582 NVIDIA® Quadro® 512MB FX 570 45J7917 NVIDIA Quadro 512MB FX 1700 43R1767 NVIDIA Quadro 512MB FX 3700 43R1768 NVIDIA Quadro 768MB FX 4600 43R1769 Other accessories at lenovo.com/accessories	

See footnotes for important warranty information
 US models announced December 18, 2007

Name	Type-model	Slot x bay	Processor	GHz	Cores	Mem-ory	Disk(s)	RAID	SATA optical	Graphics adapter(s)	1394 adptry	Sound adptry	ENERGY STAR 4.0	Preload	Workhorse Global	Avail date
S10	6423-33U	5x6	E6850	3.00	2	2GB	1 x 250GB ² SATA		DVD±RW	1 x NVS290			Pending	XP Pro	No	Apr 08
S10	6423-34U	5x6	E6850	3.00	2	2GB	1 x 250GB SATA		DVD±RW	1 x FX370			Pending	XP Pro	No	Apr 08
S10	6423-35U	5x6	E6850	3.00	2	2GB	1 x 250GB SATA		DVD±RW	1 x FX1700			Pending	XP Pro	No	Apr 08
S10	6423-36U	5x6	QX6850	3.00	4	2GB	1 x 250GB SATA		DVD±RW	1 x FX4600			Pending	XP Pro	No	Apr 08
S10	6423-37U	5x6	E6850	3.00	2	2GB	1 x 250GB SATA		Blu-ray™	1 x FX1700			Pending	XP Pro	No	Apr 08
S10	6423-38U	5x6	QX6850	3.00	4	2GB	1 x 250GB SATA		Blu-ray	1 x FX4600			Pending	XP Pro	No	Apr 08
S10	6423-49U	5x6	E6750	2.66	2	2GB	1 x 250GB SATA		DVD±RW	1 x FX370	1394		Pending	Bus32	No	Apr 08
S10	6423-51U	5x6	E6850	3.00	2	2GB	2 x 250GB SATA		DVD±RW	1 x FX1700			Pending	Bus32	No	Apr 08
S10	6423-52U	5x6	E6850	3.00	2	2GB	1 x 146GB SAS		DVD±RW	1 x FX1700			Pending	Bus32	No	Apr 08
S10	6423-53U	5x6	E6850	3.00	2	2GB	2 x 250GB SATA		DVD±RW	1 x FX1700		X-Fi	Pending	Bus32	No	Apr 08
S10	6423-54U	5x6	Q6600	2.40	4	2GB	2 x 250GB SATA		DVD±RW	1 x FX1700		X-Fi	Pending	Bus32	No	Apr 08
S10	6423-55U	5x6	Q6700	2.66	4	2GB	2 x 160GB SATA	1	DVD±RW	2 x NVS290			Pending	Bus32	No	Apr 08

- High performance workstation with premium graphics for specialized professionals
- Environmentally friendly, cool, and quiet with rock solid engineering
- These small and medium business (SMB) models are part of the US TopSeller™ Program

Processor	Intel® Core™ 2 Duo Processor E6750 or E6850 with dual-core, 1333MHz system bus, and 4MB L2 cache or Intel Core 2 Quad Processor Q6600 or Q6700 with quad-core, 1066MHz system bus, and 8MB L2 cache or Intel Core 2 Extreme Processor QX6850 with quad-core, 1333MHz system bus, and 8MB L2 cache	Tower	
Implementation	Processor uses FC-LGA6 package, one LGA775 socket	<ul style="list-style-type: none"> • Raven black color; metal case • 6.9"W x 19.0"D x 16.8"H (without handle) • 175mm W x 483mm D x 426mm H • 36 lb (16.4kg) max configuration • 31-liter • Removable handle on top front • Toolless side cover removal • Toolless disk and optical drive removal • Toolless adapter retention • Illuminated front icons • Rack shelf support 	
Memory	2GB std, 8GB max, PC3-8500 1066MHz DDR3, ECC, dual-channel capable, four 240-pin DIMM sockets; Non-italics: standard memory in two sockets; two sockets available	<ul style="list-style-type: none"> • Bay ① 5.25", 1.6" high, external, std optical • Bay ② 5.25", 1.6" high, external, open • Bay ③ 3.5", 1" high, external, std media reader • Bay ④ 3.5", 1" high, internal, std disk • Bay ⑤ 3.5", 1" high, internal, std or opt disk • Bay ⑥ 3.5", 1" high, internal, std or opt disk 	
Graphics	Two PCI Express® x16 adapters required for quad monitor support, * 76 to 150W adapters use auxiliary power connector from PSU Some: NVIDIA® Quadro® NVS 290, PCIe x16 adapter, 256MB, two single-link DVI via DMS-59 with dual DVI-I dongle, 21W Some: NVIDIA Quadro FX 370, PCIe x16 adapter, 256MB, one single-link and 1 dual-link DVI, dual DVI-I or dual VGA, 25W Some: NVIDIA Quadro FX 1700, PCIe x16 adapter, 512MB, two dual-link DVI, dual DVI-I or dual VGA, HDTV out, 42W Some: NVIDIA Quadro FX 4600, PCIe x16 adapter, 768MB, two slot width, 2 dual-link DVI, dual DVI-I or dual VGA, 134W	<ul style="list-style-type: none"> • Slot 1: full-length, full-height, PCIe 2.0 x16 (75W* max) • Slot 2: full-length, full-height, PCIe 2.0 x16 (75W* max) • Slot 3: full-length, full-height, 32-bit PCI 2.3 • Slot 4: full-length, full-height, PCIe x4 (x16 mechanical) • Slot 5: half-length, full-height, 32-bit PCI 2.3 	
Media reader	9-in-1 media reader, internal USB 2.0		
SATA disk(s)	Some: 160GB or 250GB, SATA 3.0Gb/s, 7200 rpm		
SATA controller	Serial ATA, SATA 3.0Gb/s, integrated in ICH9R		
SATA connectors	Six SATA connectors on planar		
SATA DVD±RW	Some: Super Multi-Burner DL DVD±RW SATA 1.5Gb/s (41N5620)		
SATA Blu-ray	Some: Blu-ray Burner / HD-DVD Player SATA 1.5Gb/s (43R1958)		
SAS disk	Some: 146GB, Serial Attached SCSI, 3.0Gb/s, 15000 rpm		
SAS controller	Some: LSI™ LSISAS3041E-R PCIe x4 adapter, 4-port, 3.0Gb/s, RAID® 0, 1, 1E		
Chipset	Intel X38 Express Chipset, Intel I/O Controller Hub 9 RAID (ICH9R) for RAID 0, 1, 5 support, SMC® SCH5027D Super I/O		
Front ports	Two USB 2.0, microphone (3.5mm), headphone (3.5mm), FireWire 400 (IEEE 1394)		
Rear ports	Eight USB 2.0, serial (9-pin), keyboard (PS/2), mouse (PS/2), two ethernet (RJ-45), five analog audio ports (line-in, microphone-in, front-out, rear-out, center/sub-out), optical S/PDIF digital out		
IEEE 1394 adptry	Some: FireWire PCI adapter, 1394a-2000, 400Mbps, two 6-pin ports on rear		
Audio	High Definition (HD) Audio, Analog Devices AD1988A codec; Some: Creative Sound Blaster® X-Fi, PCI adapter, high-end sound adapter		
Speaker	Internal speaker for business audio		
Ethernet	Dual gigabit ethernet on planar, Broadcom® BCM5754 and BCM5755, 2 x PCIe x1		
Security chip	Integrated in ethernet controller BCM5755, TCG 1.2-compliant		
Keyboard	Preferred Pro USB Keyboard (USB connector), 104-key, black		
Mouse	Optical Wheel Mouse (USB connector), black		
Power supply	650 watts with 120mm bottom-mounted variable speed fan, universal, 80 PLUS®		
Cooling	3 to 5 fans (power supply, CPU, rear, opt front PCI [>75W graphics], opt front [SAS])		
Rack mount	Rack shelf support		
Preloaded operating system²⁰			
- Microsoft® Windows® XP Professional	1GB PC3-8500 DDR3 ECC UDIMM	41U5251	
- Microsoft® Windows® Vista® Business Edition (32-bit)	2GB PC3-8500 DDR3 ECC UDIMM	41U5252	
◆ Vista models: Vista Premium logo	750GB SATA 3.0Gb/s Disk (7200 rpm)	43R1991	
	1TB SATA 3.0Gb/s Disk (7200 rpm)	45J7918	
Preloaded applications⁵ (all OSes; only some listed)	Super Multi-Burner DL DVD±RW SATA 1.5Gb/s	41N5620	
• Rescue and Recovery™	Blu-ray Burner / HD-DVD Player SATA 1.5Gb/s	43R1958	
• ThinkVantage Productivity Center	USB 2.0 Ultra Secure Memory Key 8GB	45J5918	
• ThinkVantage System Update	USB 2.0 Portable Secure 320GB Hard Disk	43R2019	
• Norton Internet Security™ (90 days of virus definitions)	ThinkVision® L2240p Wide 22" Monitor	4422HB6	
• Sonic RecordNow and Drive Letter Access (DVD±RW)	ThinkVision L2440p Wide 24" Monitor	4420HB2	
• Corel® WinDVD® (DVD±RW)	NVIDIA® Quadro® 512MB FX 1700	43R1767	
	NVIDIA Quadro 512MB FX 3700	43R1768	
	NVIDIA Quadro 768MB FX 4600	43R1769	
	Other accessories at lenovo.com/accessories		
			Security
			<ul style="list-style-type: none"> • Security chip (see information on left) • Side cover lock (ships with two identical keys) • Padlock loop (in rear for opt padlock; padlock prohibits side cover removal) • Security slot (in rear for optional Kensington® Microsaver® cable; prohibits side cover removal) • Chassis intrusion switch • Power-on password • Administrator password • Boot sequence control • Boot without keyboard, mouse, diskette • Serial port I/O control • USB port disablement (front or all)
			Supports ThinkVantage® technologies
			RoHS-compliant
			Pending: ENERGY STAR® 4.0-compliant
			Limited Warranty¹
			↔ 3-year parts and labor
			↔ Customer Replaceable Unit (CRU) parts only (with limited onsite service for selected parts ³ , 8 am - 5 pm, Mon - Fri coverage excluding holidays, next business day response time)
			↔ ThinkPlus™ services available; see http://lenovo.com/thinkplus/warranty
			• Onsite service upgrade options (in eligible locations) ⁷
			↔ 24 hour x 7 day ¹⁴ toll-free support during the warranty period ¹ via 800-426-7378

See footnotes for important warranty information
US models announced April 15, 2008

Name	Type-model	Slot x bay	Processor	GHz	Cores	Mem-ory	Disk(s)	RAID	SATA optical	Graphics adapter(s)	1394 adptr	Sound adptr	ENERGY STAR 4.0 Preload	Workhorse Global	Avail date	
S10	6423-56U	5x6	Q9550	2.83	4	2GB	2 x 250GB ² SATA	None	DVD±RW	1 x FX3700		None	Pending	Bus32	No	Aug 08
S10	6423-57U	5x6	Q9450	2.66	4	2GB	1 x 250GB SATA	None	DVD±RW	1 x FX570		None	Pending	Bus32	No	Aug 08
S10	6423-58U	5x6	E8200	2.66	2	2GB	1 x 250GB SATA	None	DVD±RW	1 x NVS290	1394	None	Pending	Bus64	No	Aug 08
S10	6423-59U	5x6	E8400	3.00	2	2GB	1 x 250GB SATA	None	DVD±RW	1 x FX370		None	Pending	Bus64	No	Aug 08
S10	6423-61U	5x6	E8500	3.16	2	4GB	1 x 146GB SAS	None	DVD±RW	1 x FX1700		None	Pending	Bus64	No	Aug 08
S10	6423-67U	5x6	Q9450	2.66	4	2GB	1 x 250GB SATA	None	DVD±RW	1 x FX570		None	Pending	Bus64	No	Aug 08
S10	6423-68U	5x6	Q9450	2.66	4	4GB	1 x 250GB SATA	None	DVD±RW	1 x FX1700		None	Pending	Bus64	No	Aug 08
S10	6423-69U	5x6	Q9550	2.83	4	4GB	1 x 500GB SATA	None	DVD±RW	1 x FX3700		None	Pending	Bus64	No	Aug 08
S10	6423-72U	5x6	QX9650	3.00	4	4GB	1 x 500GB SATA	None	DVD±RW	1 x FX3700		None	Pending	Bus64	No	Aug 08
S10	6423-H1U	5x6	Q9550	2.83	4	4GB	1 x 500GB SATA	None	DVD±RW	None		None	Pending	Bus64	No	Sep 08
S10	6423-H2U	5x6	E8400	3.00	2	2GB	1 x 250GB SATA	None	DVD±RW	None		None	Pending	Bus64	No	Sep 08
S10	6423-H3U	5x6	Q9550	2.83	4	4GB	1 x 146GB SAS	None	DVD±RW	None		None	Pending	Bus64	No	Sep 08
S10	6423-H4U	5x6	E8400	3.00	2	2GB	1 x 146GB SAS	None	DVD±RW	None		None	Pending	Bus64	No	Sep 08

• These small and medium business (SMB) models are part of the US TopSeller™ Program

Processor	Intel® Core™ 2 Duo Processor E8200, E8400, or E8500 with dual-core, 1333MHz system bus, and 6MB L2 cache or Intel Core 2 Quad Processor Q9450 or Q9550 with quad-core, 1333MHz system bus, and 12MB L2 cache or Intel Core 2 Extreme Processor QX9650 with quad-core, 1333MHz system bus, and 12MB L2 cache	Tower	
Implementation	Processor uses FC-LGA6 package, one LGA775 socket	<ul style="list-style-type: none"> Raven black color; metal case 6.9"W x 19.0"D x 16.8"H (without handle) 175mm W x 483mm D x 426mm H 36 lb (16.4kg) max configuration 31-liter Removable handle on top front Toolless side cover removal Toolless disk and optical drive removal Toolless adapter retention Illuminated front icons Rack shelf support 	
Memory	2GB or 4GB std, 8GB max, PC3-8500 1066MHz DDR3, ECC, dual-channel capable, four 240-pin DIMM sockets; <i>Italics:</i> standard memory in four sockets; no sockets available <i>Non-italics:</i> standard memory in two sockets; two sockets available	<ul style="list-style-type: none"> Bay ① 5.25", 1.6" high, external, std optical Bay ② 5.25", 1.6" high, external, open Bay ③ 3.5", 1" high, external, std media reader Bay ④ 3.5", 1" high, internal, std disk Bay ⑤ 3.5", 1" high, internal, std or opt disk Bay ⑥ 3.5", 1" high, internal, std or opt disk 	
Graphics	Two PCI Express® x16 adapters required for quad monitor support, * 76W to 150W adapters use auxiliary power connector from PSU Some: NVIDIA® Quadro® NVS 290, PCIe x16 adapter, 256MB, two single-link DVI via DMS-59 with dual DVI-I dongle, 21W Some: NVIDIA Quadro FX 370, PCIe x16 adapter, 256MB, one single-link and 1 dual-link DVI, dual DVI-I or dual VGA, 25W Some: NVIDIA Quadro FX 570, PCIe 2.0 x16 adapter, 256MB, two dual-link DVI, dual DVI-I or dual VGA, 38W Some: NVIDIA Quadro FX 1700, PCIe x16 adapter, 512MB, two dual-link DVI, dual DVI-I or dual VGA, HDTV out, 42W Some: NVIDIA Quadro FX 3700, PCIe 2.0 x16 adapter, 512MB, two dual-link DVI, dual DVI-I or dual VGA, 78W	<ul style="list-style-type: none"> Slot 1: full-length, full-height, PCIe 2.0 x16 (75W* max) Slot 2: full-length, full-height, PCIe 2.0 x16 (75W* max) Slot 3: full-length, full-height, 32-bit PCI 2.3 Slot 4: full-length, full-height, PCIe x4 (x16 mechanical) Slot 5: half-length, full-height, 32-bit PCI 2.3 	
Media reader	9-in-1 media reader, internal USB 2.0		
SATA disk(s)	Some: 250GB or 500GB, SATA 3.0Gb/s, 7200 rpm		
SATA controller	Serial ATA, SATA 3.0Gb/s, integrated in ICH9R		
SATA connectors	Six SATA connectors on planar		
SATA DVD±RW	Super Multi-Burner DL DVD±RW SATA 1.5Gb/s (41N5620)		
SAS disk	Some: 146GB, Serial Attached SCSI, 3.0Gb/s, 15000 rpm		
SAS controller	Some: LSI™ LSISAS3041E-R PCIe x4 adapter, 4-port, 3.0Gb/s, RAID® 0, 1, 1E		
Chipset	Intel X38 Express Chipset, Intel I/O Controller Hub 9 RAID (ICH9R) for RAID 0, 1, 5 support, SMSC® SCH5027D Super I/O	Security	<ul style="list-style-type: none"> Security chip (see information on left) Side cover lock (ships with two identical keys) Padlock loop (in rear for opt padlock; padlock prohibits side cover removal) Security slot (in rear for optional Kensington® Microsaver® cable; prohibits side cover removal) Chassis intrusion switch Power-on password Administrator password Boot sequence control Boot without keyboard, mouse, diskette Serial port I/O control USB port disablement (front or all)
Front ports	Two USB 2.0, microphone (3.5mm), headphone (3.5mm), FireWire 400 (IEEE 1394)		
Rear ports	Eight USB 2.0, serial (9-pin), keyboard (PS/2), mouse (PS/2), two ethernet (RJ-45), five analog audio ports (line-in, microphone-in, front-out, rear-out, center/sub-out), optical S/PDIF digital out		
IEEE 1394 adptr	Some: FireWire PCI adapter, 1394a-2000, 400Mbps, two 6-pin ports on rear		
Audio	High Definition (HD) Audio, Analog Devices AD1988A codec;		
Speaker	Internal speaker for business audio		
Ethernet	Dual gigabit ethernet on planar, Broadcom® BCM5754 and BCM5755, 2 x PCIe x1		
Security chip	Integrated in ethernet controller BCM5755, TCG 1.2-compliant		
Keyboard	Preferred Pro USB Keyboard (USB connector), 104-key, black		
Mouse	Optical Wheel Mouse (USB connector), black		
Power supply	650 watts with 120mm bottom-mounted variable speed fan, universal, 80 PLUS®		
Cooling	3 to 5 fans (power supply, CPU, rear, opt front PCI [>75W graphics], opt front [SAS])		
Rack mount	Rack shelf support		
Preloaded operating system²⁰	Accessories		
- Microsoft® Windows® Vista® Business Edition (32-bit)	1GB PC3-8500 DDR3 ECC UDIMM	41U5251	
- Microsoft Windows Vista Business Edition (64-bit)	2GB PC3-8500 DDR3 ECC UDIMM	41U5252	
◇ Vista models: Vista Premium logo	750GB SATA 3.0Gb/s Disk (7200 rpm)	43R1991	
Preloaded applications⁵ (all OSes; only some listed)	1TB SATA 3.0Gb/s Disk (7200 rpm)	45J7918	
• Rescue and Recovery™	Super Multi-Burner DL DVD±RW SATA 1.5Gb/s	41N5620	
• ThinkVantage Productivity Center	Blu-ray Burner / HD-DVD Player SATA 1.5Gb/s	43R1958	
• ThinkVantage System Update	USB 2.0 Ultra Secure Memory Key 8GB	45J5918	
• Norton Internet Security™	USB 2.0 Portable Secure 320GB Hard Disk	43R2019	
• Sonic RecordNow and Drive Letter Access (DVD±RW)	ThinkVision® L2240p Wide 22" Monitor	4422HB6	
• Corel® WinDVD® (DVD±RW)	ThinkVision L2440p Wide 24" Monitor	4420HB2	
	NVIDIA® Quadro® 512MB FX 1700	43R1767	
	NVIDIA Quadro 512MB FX 3700	43R1768	
	NVIDIA Quadro 768MB FX 4600	43R1769	
	Other accessories at lenovo.com/accessories		
			Limited Warranty¹
			⇒ 3-year parts and labor
			⇒ Customer Replaceable Unit (CRU) parts only (with limited onsite service for selected parts ³ , 8 am - 5 pm, Mon - Fri coverage excluding holidays, next business day response time)
			⇒ ThinkPlus™ services available; see http://lenovo.com/thinkplus/warranty
			• Onsite service upgrade options (in eligible locations) ⁷
			⇒ 24 hour x 7 day ¹⁴ toll-free support during the warranty period ¹ via 800-426-7378

See footnotes for important warranty information

US models announced September 30, 2008; previous models on August 19, 2008

Name	Type-model	Slot x bay	Processor	GHz	Cores	Mem-ory	Disk(s)	RAID	SATA optical	Graphics adapter(s)	1394 adptr	Sound adptr	ENERGY STAR 4.0	Vista preload	Workhorse Global	Avail date
S10	6483-22U	5x6	Q6700	2.66	4	2GB	1 x 250GB ² SATA		DVD±RW	1 x FX4600			ES40	Bus64	No	Jan 08
S10	6483-23U	5x6	E6850	3.00	2	2GB	1 x 146GB SAS		DVD±RW	1 x FX4600				Bus64	No	Jan 08
S10	6483-24U	5x6	QX6850	3.00	4	2GB	1 x 146GB SAS		DVD±RW	1 x FX4600	1394	X-Fi	ES40	Bus64	No	Jan 08
S10	6483-33U	5x6	QX6850	3.00	4	4GB	1 x 146GB SAS		DVD±RW	1 x FX4600	1394	X-Fi	ES40	Bus64	No	Jan 08
S10	6483-25U	5x6	Q6700	2.66	4	2GB	2 x 250GB SATA		DVD±RW	1 x FX1700			ES40	Bus64	No	Jan 08
S10	6483-26U	5x6	E6850	3.00	2	2GB	2 x 250GB SATA		DVD±RW	1 x FX1700			ES40	Bus64	No	Jan 08
S10	6483-27U	5x6	Q6600	2.40	4	2GB	1 x 146GB SAS		DVD±RW	1 x FX1700			ES40	Bus64	No	Jan 08
S10	6483-29U	5x6	Q6700	2.66	4	4GB	2 x 250GB SATA		DVD±RW	1 x FX1700			ES40	Bus64	No	Jan 08
S10	6483-31U	5x6	E6850	3.00	2	2GB	2 x 250GB SATA	1	DVD±RW	1 x FX1700			ES40	Bus64	No	Jan 08
S10	6483-32U	5x6	E6850	3.00	2	2GB	3 x 250GB SATA	5	DVD±RW	1 x FX1700			ES40	Bus64	No	Jan 08
S10	6483-19U	5x6	E6850	3.00	2	2GB	1 x 250GB SATA		DVD±RW	1 x FX1700			ES40	Bus64	No	Jan 08
S10	6483-21U	5x6	QX6800	2.93	4	4GB	2 x 500GB SATA	0	Blu-ray™	2 x FX4600		X-Fi	ES40	Bus64	No	Jan 08

- High performance workstation with premium graphics for specialized professionals
- Environmentally friendly, cool, and quiet with rock solid engineering

Processor	Intel® Core™ 2 Duo Processor E6850 with dual-core, 1333MHz system bus, and 4MB L2 cache or Intel Core 2 Quad Processor Q6600 or Q6700 with quad-core, 1066MHz system bus, and 8MB L2 cache or Intel Core 2 Extreme Processor QX6800 with quad-core, 1066MHz system bus, and 8MB L2 cache or Intel Core 2 Extreme Processor QX6850 with quad-core, 1333MHz system bus, and 8MB L2 cache	Tower	
Implementation	Processor uses FC-LGA6 package, one LGA775 socket	<ul style="list-style-type: none"> • Raven black color; metal case • 6.9"W x 19.0"D x 16.8"H (without handle) • 175mm W x 483mm D x 426mm H • 36 lb (16.4kg) max configuration • 31-liter • Removable handle on top front • Toolless side cover removal • Toolless disk and optical drive removal • Toolless adapter retention • Illuminated front icons • Rack shelf support 	
Memory	2GB or 4GB std, 8GB max, PC3-8500 1066MHz DDR3, ECC, dual-channel capable, four 240-pin DIMM sockets; <i>Italics:</i> standard memory in four sockets; no sockets available <i>Non-italics:</i> standard memory in two sockets; two sockets available	<ul style="list-style-type: none"> Bay ① 5.25", 1.6" high, external, std optical Bay ② 5.25", 1.6" high, external, open Bay ③ 3.5", 1" high, external, std media reader Bay ④ 3.5", 1" high, internal, std disk Bay ⑤ 3.5", 1" high, internal, std or opt disk Bay ⑥ 3.5", 1" high, internal, std or opt disk 	
Graphics	Two PCI Express® x16 adapters required for quad monitor support, * 76 to 150W adapters use auxiliary power connector from PSU <i>Some: NVIDIA® Quadro® FX 1700, PCIe x16 adapter, 512MB, two dual-link DVI, dual DVI-I or dual VGA, HDTV out, 42W</i> <i>Some: NVIDIA Quadro FX 4600, PCIe x16 adapter, 768MB, two slot width, 2 dual-link DVI, dual DVI-I or dual VGA, 134W</i>	<ul style="list-style-type: none"> Slot 1: full-length, full-height, PCIe 2.0 x16 (75W* max) Slot 2: full-length, full-height, PCIe 2.0 x16 (75W* max) Slot 3: full-length, full-height, 32-bit PCI 2.3 Slot 4: full-length, full-height, PCIe x4 (x16 mechanical) Slot 5: half-length, full-height, 32-bit PCI 2.3 	
Media reader	9-in-1 media reader, internal USB 2.0		
SATA disk(s)	<i>Some: 250GB or 500GB, SATA 3.0Gb/s, 7200 rpm</i>		
SATA controller	Serial ATA, SATA 3.0Gb/s, integrated in ICH9R		
SATA connectors	Six SATA connectors on planar		
SATA DVD±RW	<i>Some: Super Multi-Burner DL DVD±RW SATA 1.5Gb/s (41N5620)</i>		
SATA Blu-ray	<i>Some: Blu-ray Burner / HD-DVD Player SATA 1.5Gb/s (43R1958)</i>		
SAS disk	<i>Some: 146GB, Serial Attached SCSI, 3.0Gb/s, 15000 rpm</i>		
SAS controller	<i>Some: LSI™ LSISAS3041E-R PCIe x4 adapter, 4-port, 3.0Gb/s, RAID® 0, 1, 1E</i>		
Chipset	Intel X38 Express Chipset, Intel I/O Controller Hub 9 RAID (ICH9R) for RAID 0, 1, 5 support, SMSC® SCH5027D Super I/O	SECURITY	<ul style="list-style-type: none"> • Security chip (see information on left) • Side cover lock (ships with two identical keys) • Padlock loop (in rear for opt padlock; padlock prohibits side cover removal) • Security slot (in rear for optional Kensington® Microsaver® cable; prohibits side cover removal) • Chassis intrusion switch • Power-on password • Administrator password • Boot sequence control • Boot without keyboard, mouse, diskette • Serial port I/O control • USB port disablement (front or all)
Front ports	Two USB 2.0, microphone (3.5mm), headphone (3.5mm), FireWire 400 (IEEE 1394)		
Rear ports	Eight USB 2.0, serial (9-pin), keyboard (PS/2), mouse (PS/2), two ethernet (RJ-45), five analog audio ports (line-in, microphone-in, front-out, rear-out, center/sub-out), optical S/PDIF digital out		
IEEE 1394 adptr	<i>Some: FireWire PCI adapter, 1394a-2000, 400Mbps, two 6-pin ports on rear</i>		
Audio	High Definition (HD) Audio, Analog Devices AD1988A codec; <i>Some: Creative Sound Blaster® X-Fi, PCI adapter, high-end sound adapter</i>		
Speaker	Internal speaker for business audio		
Ethernet	Dual gigabit ethernet on planar, Broadcom® BCM5754 and BCM5755, 2 x PCIe x1		
Security chip	Integrated in ethernet controller BCM5755, TCG 1.2-compliant		
Keyboard	<i>Model 21U:</i> Lenovo USB Fingerprint Keyboard (USB connector), black <i>Others:</i> Preferred Pro USB Keyboard (USB connector), 104-key, black		
Mouse	Optical Wheel Mouse (USB connector), black		
Power supply	650 watts with 120mm bottom-mounted variable speed fan, universal, 80 PLUS®		
Cooling	3 to 5 fans (power supply, CPU, rear, opt front PCI [>75W graphics], opt front [SAS])		
Rack mount	Rack shelf support		
Preloaded operating system²⁰	Accessories		
- Microsoft® Windows® Vista® Business Edition (64-bit)	1GB PC3-8500 DDR3 ECC UDIMM	41U5251	
◇ Vista Premium logo	2GB PC3-8500 DDR3 ECC UDIMM	41U5252	
Preloaded applications⁵ (only some listed)	1TB SATA 3.0Gb/s Disk (7200 rpm)	45J7918	
• Rescue and Recovery™	750GB SATA 3.0Gb/s Disk (7200 rpm)	43R1991	
• Client Security Solution™	Super Multi-Burner DL DVD±RW SATA 1.5Gb/s	41N5620	
• ThinkVantage Fingerprint Software (fingerprint keyboard model)	Blu-ray Burner / HD-DVD Player SATA 1.5Gb/s	43R1958	
• System Migration Assistant	USB 2.0 Lenovo Webcam	40Y8519	
• Norton Internet Security™	USB 2.0 Ultra Secure Memory Key 8GB	45J5918	
• PC-Doctor™ (diagnostics)	USB 2.0 Portable Secure 320GB Hard Disk	43R2019	
• Microsoft Office 2007 Trial (60-day)	ThinkVision® L2240p Wide 22" Monitor	4422HB6	
• Sonic RecordNow and Drive Letter Access (DVD±RW)	ThinkVision L2440x Wide 24" Monitor	4421HB2	
• Corel® WinDVD® (DVD±RW, Blu-ray)	Wireless Kbd & Opt Wheel Mouse (via USB)	73P4067	
• Ulead® DVD MovieFactory (Blu-ray)	Laser Tilt Wheel Mouse (USB, PS/2)	41U3074	
	NVIDIA® Quadro® 512MB FX 570	45J7917	
	NVIDIA Quadro 512MB FX 1700	43R1767	
	NVIDIA Quadro 512MB FX 3700	43R1768	
	Other accessories at lenovo.com/accessories		
			Supports ThinkVantage® technologies
			RoHS-compliant
			<i>Some: ENERGY STAR 4.0-compliant</i>
			LIMITED WARRANTY¹
			⇒ 3-year parts and labor
			⇒ Customer Replaceable Unit (CRU) parts only (with limited onsite service for selected parts ³ , 8 am - 5 pm, Mon - Fri coverage excluding holidays, next business day response time)
			⇒ ThinkPlus™ services available; see http://lenovo.com/thinkplus/warranty
			• Onsite service upgrade options (in eligible locations) ⁷
			• Post warranty maintenance services
			⇒ 24 hour x 7 day ¹⁴ toll-free support during the warranty period ¹ via 800-426-7378

See footnotes for important warranty information
US models announced December 18, 2007

Name	Type-model	Slot x bay	Processor	GHz	Cores	Mem-ory	Disk(s)	RAID	SATA optical	Graphics adapter(s)	1394 adptry	Sound adptry	ENERGY STAR 4.0	Preload	Workhorse Global	Avail date
S10	6483-34U	5x6	E6850	3.00	2	2GB	1 x 250GB ² SATA		DVD±RW	1 x NVS290	None	None	Pending	XP Pro	No	Apr 08
S10	6483-35U	5x6	E6850	3.00	2	2GB	1 x 250GB SATA		DVD±RW	1 x FX370	None	None	Pending	XP Pro	No	Apr 08
S10	6483-36U	5x6	E6850	3.00	2	2GB	1 x 250GB SATA		DVD±RW	1 x FX1700	None	None	Pending	XP Pro	No	Apr 08
S10	6483-37U	5x6	QX6850	3.00	4	2GB	1 x 250GB SATA		DVD±RW	1 x FX1700	None	None	Pending	XP Pro	No	Apr 08
S10	6483-38U	5x6	QX6850	3.00	4	2GB	1 x 250GB SATA		DVD±RW	1 x FX4600	None	None	Pending	XP Pro	No	Apr 08
S10	6483-39U	5x6	E6850	3.00	2	2GB	1 x 146GB SAS		DVD±RW	1 x FX1700	None	None	Pending	XP Pro	No	Apr 08
S10	6483-41U	5x6	QX6850	3.00	4	2GB	1 x 146GB SAS		DVD±RW	1 x FX1700	None	None	Pending	XP Pro	No	Apr 08
S10	6483-42U	5x6	QX6850	3.00	4	2GB	1 x 146GB SAS		DVD±RW	1 x FX4600	None	None	Pending	XP Pro	No	Apr 08
S10	6483-43U	5x6	E6850	3.00	2	2GB	2 x 250GB SATA	1	DVD±RW	1 x FX1700	None	None	Pending	XP Pro	No	Apr 08
S10	6483-44U	5x6	QX6850	3.00	4	2GB	2 x 250GB SATA	1	DVD±RW	1 x FX1700	None	None	Pending	XP Pro	No	Apr 08
S10	6483-45U	5x6	QX6850	3.00	4	2GB	2 x 250GB SATA	1	DVD±RW	1 x FX4600	None	None	Pending	XP Pro	No	Apr 08
S10	6483-46U	5x6	E6850	3.00	2	2GB	1 x 250GB SATA		Blu-ray™	1 x FX1700	None	None	Pending	XP Pro	No	Apr 08
S10	6483-47U	5x6	QX6850	3.00	4	2GB	1 x 250GB SATA		Blu-ray	1 x FX4600	None	None	Pending	XP Pro	No	Apr 08
S10	6483-92U	5x6	E6850	3.00	2	2GB	1 x 250GB SATA		DVD±RW	1 x FX1700	None	None	Pending	Bus32	No	Apr 08
S10	6483-93U	5x6	Q6700	2.66	4	2GB	1 x 250GB SATA		DVD±RW	1 x FX4600	None	None	Pending	Bus32	No	Apr 08
S10	6483-94U	5x6	E6850	3.00	2	2GB	2 x 250GB SATA		DVD±RW	1 x FX1700	None	None	Pending	Bus32	No	Apr 08
S10	6483-95U	5x6	E6850	3.00	2	2GB	2 x 250GB SATA	1	DVD±RW	1 x FX1700	None	None	Pending	Bus32	No	Apr 08
S10	6483-96U	5x6	E6850	3.00	2	2GB	3 x 250GB SATA	5	DVD±RW	1 x FX1700	None	None	Pending	Bus32	No	Apr 08

- High performance workstation with premium graphics for specialized professionals
- Environmentally friendly, cool, and quiet with rock solid engineering

Processor	Intel® Core™ 2 Duo Processor E6850 with dual-core, 1333MHz system bus, and 4MB L2 cache or Intel Core 2 Quad Processor Q6700 with quad-core, 1066MHz system bus, and 8MB L2 cache or Intel Core 2 Extreme Processor QX6850 with quad-core, 1333MHz system bus, and 8MB L2 cache	Tower	
Implementation	Processor uses FC-LGA6 package, one LGA775 socket	<ul style="list-style-type: none"> • Raven black color; metal case • 6.9"W x 19.0"D x 16.8"H (without handle) • 175mm W x 483mm D x 426mm H • 36 lb (16.4kg) max configuration • 31-liter • Removable handle on top front • Toolless side cover removal • Toolless disk and optical drive removal • Toolless adapter retention • Illuminated front icons • Rack shelf support 	
Memory	2GB std, 8GB max, PC3-8500 1066MHz DDR3, ECC, dual-channel capable, four 240-pin DIMM sockets; <i>Non-italics</i> : standard memory in two sockets; two sockets available	Bay ① 5.25", 1.6" high, external, std optical Bay ② 5.25", 1.6" high, external, open Bay ③ 3.5", 1" high, external, std media reader Bay ④ 3.5", 1" high, internal, std disk Bay ⑤ 3.5", 1" high, internal, std or opt disk Bay ⑥ 3.5", 1" high, internal, std or opt disk	
Graphics	Two PCI Express® x16 adapters required for quad monitor support, * 76 to 150W adapters use auxiliary power connector from PSU <i>Some</i> : NVIDIA® Quadro® NVS 290, PCIe x16 adapter, 256MB, two single-link DVI via DMS-59 with dual DVI-I dongle, 21W <i>Some</i> : NVIDIA Quadro FX 370, PCIe x16 adapter, 256MB, one single-link and 1 dual-link DVI, dual DVI-I or dual VGA, 25W <i>Some</i> : NVIDIA Quadro FX 1700, PCIe x16 adapter, 512MB, two dual-link DVI, dual DVI-I or dual VGA, HDTV out, 42W <i>Some</i> : NVIDIA Quadro FX 4600, PCIe x16 adapter, 768MB, two slot width, 2 dual-link DVI, dual DVI-I or dual VGA, 134W	Slot 1: full-length, full-height, PCIe 2.0 x16 (75W* max) Slot 2: full-length, full-height, PCIe 2.0 x16 (75W* max) Slot 3: full-length, full-height, 32-bit PCI 2.3 Slot 4: full-length, full-height, PCIe x4 (x16 mechanical) Slot 5: half-length, full-height, 32-bit PCI 2.3	
Media reader	9-in-1 media reader, internal USB 2.0	Security <ul style="list-style-type: none"> • Security chip (see information on left) • Side cover lock (ships with two identical keys) • Padlock loop (in rear for opt padlock; padlock prohibits side cover removal) • Security slot (in rear for optional Kensington® Microsaver® cable; prohibits side cover removal) • Chassis intrusion switch • Power-on password • Administrator password • Boot sequence control • Boot without keyboard, mouse, diskette • Serial port I/O control • USB port disablement (front or all) Supports ThinkVantage® technologies	
SATA disk(s)	<i>Some</i> : 250GB, SATA 3.0Gb/s, 7200 rpm		
SATA controller	Serial ATA, SATA 3.0Gb/s, integrated in ICH9R	RoHS-compliant Pending: ENERGY STAR 4.0-compliant	
SATA connectors	Six SATA connectors on planar		
SATA DVD±RW	<i>Some</i> : Super Multi-Burner DL DVD±RW SATA 1.5Gb/s (41N5620)	Limited Warranty¹ <ul style="list-style-type: none"> ↔ 3-year parts and labor ↔ Customer Replaceable Unit (CRU) parts only (with limited onsite service for selected parts³, 8 am - 5 pm, Mon - Fri coverage excluding holidays, next business day response time) ↔ ThinkPlus™ services available; see http://lenovo.com/thinkplus/warranty ↔ 24 hour x 7 day¹⁴ toll-free support during the warranty period¹ 	
SATA Blu-ray	<i>Some</i> : Blu-ray Burner / HD-DVD Player SATA 1.5Gb/s (43R1958)		
SAS disk	<i>Some</i> : 146GB, Serial Attached SCSI, 3.0Gb/s, 15000 rpm	Other accessories at lenovo.com/accessories	
SAS controller	<i>Some</i> : LSI™ LSI SAS3041E-R PCIe x4 adapter, 4-port, 3.0Gb/s, RAID® 0, 1, 1E		
Chipset	Intel X38 Express Chipset, Intel I/O Controller Hub 9 RAID (ICH9R) for RAID 0, 1, 5 support, SMSC® SCH5027D Super I/O		
Front ports	Two USB 2.0, microphone (3.5mm), headphone (3.5mm), FireWire 400 (IEEE 1394)		
Rear ports	Eight USB 2.0, serial (9-pin), keyboard (PS/2), mouse (PS/2), two ethernet (RJ-45), five analog audio ports (line-in, microphone-in, front-out, rear-out, center/sub-out), optical S/PDIF digital out		
IEEE 1394 adptry	None		
Audio	High Definition (HD) Audio, Analog Devices AD1988A codec;		
Speaker	Internal speaker for business audio		
Ethernet	Dual gigabit ethernet on planar, Broadcom® BCM5754 and BCM5755, 2 x PCIe x1		
Security chip	Integrated in ethernet controller BCM5755, TCG 1.2-compliant		
Keyboard	Preferred Pro USB Keyboard (USB connector), 104-key, black		
Mouse	Optical Wheel Mouse (USB connector), black		
Power supply	650 watts with 120mm bottom-mounted variable speed fan, universal, 80 PLUS®		
Cooling	3 to 5 fans (power supply, CPU, rear, opt front PCI [>75W graphics], opt front [SAS])		
Rack mount	Rack shelf support		
Preloaded operating system²⁰	Accessories		
- Microsoft® Windows® XP Professional	1GB PC3-8500 DDR3 ECC UDIMM	41U5251	
- Microsoft Windows Vista® Business Edition (32-bit)	2GB PC3-8500 DDR3 ECC UDIMM	41U5252	
↔ Vista models: Vista Premium logo	750GB SATA 3.0Gb/s Disk (7200 rpm)	43R1991	
Preloaded applications⁵ (all OSes; only some listed)	1TB SATA 3.0Gb/s Disk (7200 rpm)	45J7918	
• Rescue and Recovery™	Blu-ray Burner / HD-DVD Player SATA 1.5Gb/s	43R1958	
• ThinkVantage System Update	USB 2.0 Ultra Secure Memory Key 8GB	45J5918	
• Sonic RecordNow and Drive Letter Access (DVD±RW)	USB 2.0 Portable Secure 320GB Hard Disk	43R2019	
• Corel® WinDVD® (DVD±RW, Blu-ray)	ThinkVision® L2440p Wide 24" Monitor	4420HB2	
• Ulead® DVD MovieFactory (Blu-ray)	NVIDIA® Quadro® 512MB FX 570	45J7917	
	NVIDIA Quadro 512MB FX 1700	43R1767	
	NVIDIA Quadro 512MB FX 3700	43R1768	

See footnotes for important warranty information
US models announced April 15, 2008

Name	Type-model	Slot x bay	Processor	GHzCores	Mem-ory	Disk(s)	RAID	SATA optical	Graphics adapter(s)	1394 adptr	Sound adptr	ENERGY STAR 4.0	Preload	Workhorse Global	Avail date
S10	6483-A1U	5x6	Q9450	2.66	4	2GB 1 x 250GB SATA	None	DVD±RW	1 x FX3700		None	Pending	Bus64	No	Aug 08
S10	6483-A2U	5x6	Q9450	2.66	4	2GB 1 x 250GB SATA	None	DVD±RW	1 x FX570		None	Pending	Bus64	No	Aug 08
S10	6483-A3U	5x6	Q9550	2.83	4	2GB 1 x 250GB SATA	None	DVD±RW	1 x FX570		None	Pending	Bus64	No	Aug 08
S10	6483-A4U	5x6	Q9550	2.83	4	2GB 1 x 250GB SATA	None	DVD±RW	1 x FX3700		None	Pending	Bus64	No	Aug 08
S10	6483-B2U	5x6	Q9450	2.66	4	4GB 1 x 146GB SAS	None	DVD±RW	1 x FX1700	1394	None	Pending	Bus64	No	Aug 08
S10	6483-B3U	5x6	Q9550	2.83	4	4GB 2 x 250GB SATA	None	DVD±RW	1 x FX1700		None	Pending	Bus64	No	Aug 08
S10	6483-B4U	5x6	Q9550	2.83	4	4GB 1 x 146GB SAS	None	DVD±RW	1 x FX3700		None	Pending	Bus64	No	Aug 08
S10	6483-B5U	5x6	QX9650	3.00	4	4GB 2 x 250GB SATA	None	DVD±RW	1 x FX1700		None	Pending	Bus64	No	Aug 08
S10	6483-B8U	5x6	E8200	2.66	2	2GB 1 x 160GB SATA	None	DVD	1 x FX570	1394	None	Pending	Bus64	No	Aug 08
S10	6483-B9U	5x6	E8200	2.66	2	2GB 1 x 160GB SATA	None	DVD	1 x FX3700	1394	None	Pending	Bus64	No	Aug 08
S10	6483-C1U	5x6	E8400	3.00	2	2GB 2 x 250GB SATA	None	DVD±RW	1 x FX1700		None	Pending	Bus64	No	Aug 08
S10	6483-C2U	5x6	E8500	3.16	2	4GB 2 x 250GB SATA	None	DVD±RW	1 x FX3700		None	Pending	Bus64	No	Aug 08
S10	6483-E1U	5x6	QX9650	3.00	4	4GB 2 x 500GB SATA	None	DVD±RW	1 x FX1700		None	Pending	Bus64	No	Aug 08
S10	6483-E2U	5x6	QX9650	3.00	4	4GB 2 x 500GB SATA	None	DVD±RW	1 x FX3700		None	Pending	Bus64	No	Aug 08

Processor	Intel® Core™ 2 Duo Processor E8200, E8400, or E8500 with dual-core, 1333MHz system bus, and 6MB L2 cache or Intel Core 2 Quad Processor Q9450 or Q9550 with quad-core, 1333MHz system bus, and 12MB L2 cache or Intel Core 2 Extreme Processor QX9650 with quad-core, 1333MHz system bus, and 12MB L2 cache	Tower	
Implementation	Processor uses FC-LGA6 package, one LGA775 socket	<ul style="list-style-type: none"> Raven black color; metal case 6.9"W x 19.0"D x 16.8"H (without handle) 175mm W x 483mm D x 426mm H 36 lb (16.4kg) max configuration 31-liter Removable handle on top front Toolless side cover removal Toolless disk and optical drive removal Toolless adapter retention Illuminated front icons Rack shelf support 	
Memory	2GB or 4GB std, 8GB max, PC3-8500 1066MHz DDR3, ECC, dual-channel capable, four 240-pin DIMM sockets; <i>Italics:</i> standard memory in four sockets; no sockets available <i>Non-italics:</i> standard memory in two sockets; two sockets available	<ul style="list-style-type: none"> Bay ① 5.25", 1.6" high, external, std optical Bay ② 5.25", 1.6" high, external, open Bay ③ 3.5", 1" high, external, std media reader Bay ④ 3.5", 1" high, internal, std disk Bay ⑤ 3.5", 1" high, internal, std or opt disk Bay ⑥ 3.5", 1" high, internal, std or opt disk 	
Graphics	Two PCI Express® x16 adapters required for quad monitor support, * 76 to 150W adapters use auxiliary power connector from PSU Some: NVIDIA® Quadro® FX 570, PCIe 2.0 x16 adapter, 256MB, two dual-link DVI, dual DVI-I or dual VGA, 38W Some: NVIDIA Quadro FX 1700, PCIe x16 adapter, 512MB, two dual-link DVI, dual DVI-I or dual VGA, HDTV out, 42W Some: NVIDIA Quadro FX 3700, PCIe 2.0 x16 adapter, 512MB, two dual-link DVI, dual DVI-I or dual VGA, 78W	<ul style="list-style-type: none"> Slot 1: full-length, full-height, PCIe 2.0 x16 (75W* max) Slot 2: full-length, full-height, PCIe 2.0 x16 (75W* max) Slot 3: full-length, full-height, 32-bit PCI 2.3 Slot 4: full-length, full-height, PCIe x4 (x16 mechanical) Slot 5: half-length, full-height, 32-bit PCI 2.3 	
Media reader	9-in-1 media reader, internal USB 2.0		
SATA disk(s)	Some: 160GB, 250GB, or 500GB, SATA 3.0Gb/s, 7200 rpm		
SATA controller	Serial ATA, SATA 3.0Gb/s, integrated in ICH9R		
SATA connectors	Six SATA connectors on planar		
SATA DVD	Some: DVD-ROM DL SATA1.5Gb/s 16X-48X Max ⁴ (41N5618)		
SATA DVD±RW	Some: Super Multi-Burner DL DVD±RW SATA 1.5Gb/s (41N5620)		
SAS disk	Some: 146GB, Serial Attached SCSI, 3.0Gb/s, 15000 rpm		
SAS controller	Some: LSI™ LSISAS3041E-R PCIe x4 adapter, 4-port, 3.0Gb/s, RAID® 0, 1, 1E		
Chipset	Intel X38 Express Chipset, Intel I/O Controller Hub 9 RAID (ICH9R) for RAID 0, 1, 5 support, SMSC® SCH5027D Super I/O	Security	
Front ports	Two USB 2.0, microphone (3.5mm), headphone (3.5mm), FireWire 400 (IEEE 1394)	<ul style="list-style-type: none"> Security chip (see information on left) Side cover lock (ships with two identical keys) Padlock loop (in rear for opt padlock; padlock prohibits side cover removal) Security slot (in rear for optional Kensington® Microsaver® cable; prohibits side cover removal) Chassis intrusion switch Power-on password Administrator password Boot sequence control Boot without keyboard, mouse, diskette Serial port I/O control USB port disablement (front or all) 	
Rear ports	Eight USB 2.0, serial (9-pin), keyboard (PS/2), mouse (PS/2), two ethernet (RJ-45), five analog audio ports (line-in, microphone-in, front-out, rear-out, center/sub-out), optical S/PDIF digital out		
IEEE 1394 adptr	Some: FireWire PCI adapter, 1394a-2000, 400Mbps, two 6-pin ports on rear		
Audio	High Definition (HD) Audio, Analog Devices AD1988A codec;		
Speaker	Internal speaker for business audio		
Ethernet	Dual gigabit ethernet on planar, Broadcom® BCM5754 and BCM5755, 2 x PCIe x1		
Security chip	Integrated in ethernet controller BCM5755, TCG 1.2-compliant		
Keyboard	Preferred Pro USB Keyboard (USB connector), 104-key, black		
Mouse	Optical Wheel Mouse (USB connector), black		
Power supply	650 watts with 120mm bottom-mounted variable speed fan, universal, 80 PLUS®		
Cooling	3 to 5 fans (power supply, CPU, rear, opt front PCI [>75W graphics], opt front [SAS])		
Rack mount	Rack shelf support		
Preloaded operating system²⁰	Accessories		
- Microsoft® Windows® Vista® Business Edition (64-bit)	1GB PC3-8500 DDR3 ECC UDIMM	41U5251	
◇ Vista models: Vista Premium logo	2GB PC3-8500 DDR3 ECC UDIMM	41U5252	
Preloaded applications⁵	750GB SATA 3.0Gb/s Disk (7200 rpm)	43R1991	
• Rescue and Recovery™	1TB SATA 3.0Gb/s Disk (7200 rpm)	45J7918	
• Client Security Solution™	146GB SAS 3.0Gb/s Disk (15000 rpm)	43R1993	
• ThinkVantage Productivity Center	300GB SAS 3.0Gb/s Disk (15000 rpm)	43R1994	
• ThinkVantage System Update	Super Multi-Burner DL DVD±RW SATA 1.5Gb/s	41N5620	
• System Migration Assistant	Blu-ray Burner / HD-DVD Player SATA 1.5Gb/s	43R1958	
• Norton Internet Security™ (90 days of virus definitions)	USB 2.0 Ultra Secure Memory Key 8GB	45J5918	
• PC-Doctor™ (diagnostics)	USB 2.0 Portable Secure 320GB Hard Disk	43R2019	
• Adobe® Reader	ThinkVision® L1940p Wide 19" Monitor	4424HB6	
• Microsoft Office 2007 Trial (60-day)	ThinkVision L2240p Wide 22" Monitor	4422HB6	
• Sonic RecordNow and Drive Letter Access (DVD±RW)	ThinkVision L2440x Wide 24" Monitor	4421HB2	
• Corel® WinDVD® (DVD±RW)	NVIDIA® Quadro® 512MB FX 1700	43R1767	
	NVIDIA Quadro 512MB FX 3700	43R1768	
	NVIDIA Quadro 768MB FX 4600	43R1769	
	Other accessories at lenovo.com/accessories		
		Supports ThinkVantage® technologies	
		RoHS-compliant	
		Pending: ENERGY STAR® 4.0-compliant	
		Limited Warranty¹	
		⇒ 3-year parts and labor	
		⇒ Customer Replaceable Unit (CRU) parts only (with limited onsite service for selected parts ³ , 8 am - 5 pm, Mon - Fri coverage excluding holidays, next business day response time)	
		⇒ ThinkPlus™ services available; see http://lenovo.com/thinkplus/warranty	
		• Onsite service upgrade options (in eligible locations) ⁷	
		⇒ 24 hour x 7 day ¹⁴ toll-free support during the warranty period ¹ via 800-426-7378	

See footnotes for important warranty information
US models announced August 19, 2008

ThinkStation



Lenovo ThinkStation D10



Lenovo ThinkStation S10 (left)
Lenovo ThinkStation D10 (right)



Lenovo ThinkStation D10



Lenovo ThinkStation D10



ThinkStation Rail Kit (43R1964)



Lenovo ThinkStation D10

Name	Type-model	Slot x bay	Processor(s)	GHz	Memory	Disk(s)	RAID	SATA optical	Graphics adapter(s)	1394 adpdr	Sound adpdr	ENERGY STAR 4.0	Preload	Avail date
D10	6427-27U	7x9	1 x E5430	2.66	2 x 1GB	2 x 250GB	SATA	DVD±RW	1 x FX1700	None		ES40	Bus64	Mar 08
D10	6427-28U	7x9	2 x E5430	2.66	4 x 1GB	2 x 250GB	SATA	DVD±RW	1 x FX1700	None	X-Fi	ES40	Bus64	Mar 08
D10	6427-34U	7x9	2 x E5430	2.66	4 x 1GB	2 x 250GB	SATA	DVD±RW, Blu-ray	1 x FX4600	None	X-Fi	ES40	Bus64	Mar 08
D10	6427-29U	7x9	2 x E5440	2.83	2 x 2GB	2 x 146GB	SAS	DVD±RW	1 x FX1700	None	X-Fi	ES40	Bus64	Mar 08
D10	6427-31U	7x9	2 x E5430	2.66	4 x 1GB	2 x 250GB	SATA	DVD±RW	1 x FX1700	None		ES40	Bus64	Mar 08
D10	6427-32U	7x9	2 x E5430	2.66	2 x 2GB	2 x 146GB	SAS	1 DVD±RW	1 x FX1700	None		ES40	Bus64	Mar 08
D10	6427-33U	7x9	2 x E5430	2.66	2 x 1GB	2 x 250GB	SATA	1 DVD±RW	2 x NVS290	None		ES40	Bus64	Mar 08
ES	D10	6427-73U	7x9	1 x E5430	2.66	2 x 1GB	1 x 250GB	SATA	DVD±RW	1 x FX1700	None	Pending	XP Pro	Apr 08
ES	D10	6427-35U	7x9	1 x E5440	2.83	2 x 1GB	1 x 250GB	SATA	DVD±RW	1 x FX1700	None	Pending	XP Pro	Apr 08
ES	D10	6427-36U	7x9	2 x E5430	2.66	2 x 1GB	1 x 250GB	SATA	DVD±RW	1 x FX4600	None	Pending	XP Pro	Apr 08
ES	D10	6427-37U	7x9	2 x E5440	2.83	2 x 1GB	1 x 250GB	SATA	DVD±RW	1 x FX4600	None	Pending	XP Pro	Apr 08

- High performance workstation with premium graphics for specialized professionals
- Environmentally friendly, cool, and quiet with rock solid engineering
- These small and medium business (SMB) models are part of the US TopSeller™ Program

Processor(s)	One or two processors, Intel® Xeon® processor E5430 or E5440 with quad-core , 1333MHz system bus, and 12MB L2 cache	Tower <ul style="list-style-type: none"> • Raven black color; metal case • 8.3"W x 23.7"D x 17.1"H (without handle) • 210mm W x 602mm D x 434mm H • 65 lb (29.5kg) max configuration • 49-liter • Removable handle on top front • Toolless side cover removal • Toolless disk and optical drive removal • Toolless adapter retention • Illuminated front icons • Rack shelf support or optional rail kit 	
Implementation	Processor uses FC-LGA6 package, two LGA771 sockets		
Memory	2GB or 4GB std, 64GB max, PC2-5300 667MHz DDR2, ECC , fully buffered, 4-channel capable, eight 240-pin DIMM sockets; <i>Non-italics</i> : standard memory in two or four sockets; six or four sockets available	Bay ① 5.25", 1.6" high, external, std optical Bay ② 5.25", 1.6" high, external, open Bay ③ 5.25", 1.6" high, external, open Bay ④ 3.5", 1" high, external, std media reader Bay ⑤ 3.5", 1" high, internal, std disk Bay ⑥ 3.5", 1" high, internal, std disk Bay ⑦ 3.5", 1" high, internal, std or opt disk Bay ⑧ 3.5", 1" high, internal, std or opt disk Bay ⑨ 3.5", 1" high, internal, opt disk	
Graphics	Two PCI Express® x16 adapters required for quad monitor support, * 76 to 150W adapters use auxiliary power connector from PSU <i>Some: NVIDIA® Quadro® NVS 290</i> , PCIe x16 adapter, 256MB, two single-link DVI via DMS-59 with dual DVI-I dongle, 21W <i>Some: NVIDIA Quadro FX 1700</i> , PCIe x16 adapter, 512MB, two dual-link DVI, dual DVI-I or dual VGA, HDTV out, 42W <i>Some: NVIDIA Quadro FX 4600</i> , PCIe x16 adapter, 768MB, two slot width, 2 dual-link DVI, dual DVI-I or dual VGA, 134W	Slot 1: half-length, full-height, PCIe x4 (x8 mechanical) Slot 2: full-length, full-height, PCIe 2.0 x16 (75W* max) Slot 3: full-length, full-height, PCIe x4 (x8 mechanical) Slot 4: full-length, full-height, PCIe 2.0 x16 (75W* max) Slot 5: full-length, full-height, 64-bit PCI-X Slot 6: full-length, full-height, 64-bit PCI-X Slot 7: full-length, full-height, 32-bit PCI 2.3	
Media reader	9-in-1 media reader, internal USB 2.0		
SATA disk(s)	<i>Some: 250GB</i> , SATA 3.0Gb/s, 7200 rpm		
SATA controller	Serial ATA, SATA 3.0Gb/s, integrated in 6321ESB		
SATA connectors	Five SATA connectors on planar		
SATA DVD±RW	<i>Some: Super Multi-Burner DL DVD±RW SATA 1.5Gb/s (41N5620)</i>		
SATA Blu-ray	<i>Some: Blu-ray™ Burner / HD-DVD Player SATA 1.5Gb/s (43R1958)</i>		
SAS disk	<i>Some: 146GB</i> , Serial Attached SCSI, 3.0Gb/s, 15000 rpm		
SAS controller	LSI™ LSISAS1068E chipset, 5 connectors, 3.0Gb/s, RAID® 0, 1, 1E		
Chipset	Intel 5400A Chipset , Intel 6321ESB I/O Controller Hub for RAID 0, 1, 5, 10 support, Winbond® W83627EHG Super I/O		
Front ports	Two USB 2.0, microphone (3.5mm), headphone (3.5mm), FireWire 400 (IEEE 1394)		
Rear ports	Four USB 2.0, serial (9-pin), keyboard (PS/2), mouse (PS/2), two ethernet (RJ-45), six analog audio ports (line-in, mic-in, front-out, side-out, rear-out, center/sub-out), RCA-type coaxial digital in, RCA-type coaxial digital out		
IEEE 1394 adpdr	None		
Audio	High Definition (HD) Audio, Realtek® ALC888 codec; <i>Some: Creative Sound Blaster® X-Fi</i> , PCI adapter, high-end sound adapter		
Speaker	Internal speaker for business audio		
Ethernet	Dual gigabit ethernet on planar, Intel® 82563EB, proprietary Intel bus		
Security chip	Winbond WPCT200 SafeKeeper™ Trusted Platform Module, TCG 1.2-compliant		SECURITY <ul style="list-style-type: none"> • Security chip (see information on left) • Side cover lock (ships with two identical keys) • Padlock loop (in rear for opt padlock; padlock prohibits side cover removal) • Security slot (in rear for optional Kensington® Microsaver® cable; prohibits side cover removal) • Power-on password • Administrator password • Boot sequence control • Boot without keyboard, mouse, diskette • Serial port I/O control • USB port disablement (front or all)
Keyboard	Preferred Pro USB Keyboard (USB connector), 104-key, black		
Mouse	Optical Wheel Mouse (USB connector), black		
Power supply	1000 watts with 120mm bottom-mounted variable speed fan, universal, 80 PLUS®		
Cooling	Five fans (power supply, first processor, second processor, rear, front disk)		
Rack mount	Rack shelf support or optional sliding rack mount rail kit support		
Preloaded operating system²⁰	Accessories		
- Microsoft® Windows® XP Professional	Intel Xeon Quad-Core Processor E5430	43R2012	
- Microsoft Windows Vista® Business Edition (64-bit)	Intel Xeon Quad-Core Processor E5440	43R2013	
◆ Vista models: Vista Premium logo	2GB PC2-5300 DDR2 ECC FB-DIMM	43R1772	
Preloaded applications⁵ (all OSes; only some listed)	4GB PC2-5300 DDR2 ECC FB-DIMM	43R1773	
• Rescue and Recovery™	750GB SATA 3.0Gb/s Disk (7200 rpm)	43R1991	
• Client Security Solution™	1TB SATA 3.0Gb/s Disk (7200 rpm)	45J7918	
• ThinkVantage Productivity Center	73GB SAS 3.0Gb/s Disk (15000 rpm)	43R1992	
• ThinkVantage System Update	146GB SAS 3.0Gb/s Disk (15000 rpm)	43R1993	
• System Migration Assistant	300GB SAS 3.0Gb/s Disk (15000 rpm)	43R1994	
• Norton Internet Security™ (90 days of virus definitions)	Blu-ray Burner / HD-DVD Player SATA 1.5Gb/s	43R1958	
• PC-Doctor™ (diagnostics)	ThinkStation Rail Kit	43R1964	
• Microsoft Office 2007 Trial (60-day)	USB 2.0 Ultra Secure Memory Key 8GB	45J5918	
• Sonic RecordNow and Drive Letter Access (DVD±RW)	USB 2.0 Portable Secure 320GB Hard Disk	43R2019	
• Corel® WinDVD® (DVD±RW, Blu-ray)	ThinkVision L2440p Wide 24" Monitor	4420HB2	
• Ulead® DVD MovieFactory (Blu-ray)	Laser Tilt Wheel Mouse (USB, PS/2)	41U3074	
	NVIDIA® Quadro® 512MB FX 570	45J7917	
	NVIDIA Quadro 512MB FX 1700	43R1767	
	NVIDIA Quadro 512MB FX 3700	43R1768	
	Other accessories at lenovo.com/accessories		
			Supports ThinkVantage® technologies
			RoHS-compliant <i>Some: ENERGY STAR® 4.0-compliant</i>
			LIMITED WARRANTY¹
			⇨ 3-year parts and labor
			⇨ Customer Replaceable Unit (CRU) parts only (with limited onsite service for selected parts ³ , 8 am - 5 pm, Mon - Fri coverage excluding holidays, next business day response time)
			⇨ ThinkPlus™ services available; see http://lenovo.com/thinkplus/warranty
			⇨ 24x7 ¹⁴ toll-free support for warranty issues during the warranty period ¹ via 800-426-7378

See footnotes for important warranty information

ES US models announced April 15, 2008; previous models on March 11, 2008

ThinkStation® D10 (6427) - TopSeller (August 2008)

Personal Systems Reference (PSREF)

Name	Type-model	Slot x bay	Processor(s)	GHz	Memory	Disk(s)	RAID	SATA optical	Graphics adapter(s)	1394 adpdr	Sound adpdr	ENERGY STAR 4.0	Preload	Avail date
D10	6427-74U	7x9	2 x E5440	2.83	2 x 1GB	1 x 250GB SATA	None	DVD±RW	1 x FX3700	None	None	Pending	Bus64	Aug 08
D10	6427-88U	7x9	1 x E5450	3.00	2 x 2GB	1 x 146GB SAS	None	DVD±RW	1 x FX3700	None	None	Pending	Bus64	Aug 08
D10	6427-89U	7x9	2 x E5440	2.83	2 x 1GB	1 x 250GB SATA	None	DVD±RW	1 x FX570	None	None	Pending	Bus64	Aug 08
D10	6427-91U	7x9	1 x E5450	3.00	2 x 2GB	1 x 146GB SAS	None	DVD±RW	1 x FX570	None	None	Pending	Bus64	Aug 08
ES	D10	6427-H5U	7x9	1 x E5440	2.83	2 x 2GB	1 x 500GB SATA	None	DVD±RW	None	None	Pending	Bus64	Sep 08
ES	D10	6427-H6U	7x9	1 x E5420	2.50	2 x 2GB	1 x 500GB SATA	None	DVD±RW	None	None	Pending	Bus64	Sep 08
ES	D10	6427-H7U	7x9	1 x E5440	2.83	4 x 2GB	1 x 146GB SAS	None	DVD±RW	None	None	Pending	Bus64	Sep 08
ES	D10	6427-H8U	7x9	1 x E5420	2.50	4 x 2GB	1 x 146GB SAS	None	DVD±RW	None	None	Pending	Bus64	Sep 08

- High performance workstation with premium graphics for specialized professionals
- Environmentally friendly, cool, and quiet with rock solid engineering
- These small and medium business (SMB) models are part of the US TopSeller™ Program

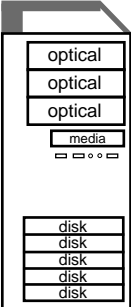
Processor(s)	One or two processors, Intel® Xeon® processor E5420, E5440, or E5450 with quad-core, 1333MHz system bus, and 12MB L2 cache	Tower	<ul style="list-style-type: none"> • Raven black color; metal case • 8.3"W x 23.7"D x 17.1"H (without handle) • 210mm W x 602mm D x 434mm H • 65 lb (29.5kg) max configuration • 49-liter • Removable handle on top front • Toolless side cover removal • Toolless disk and optical drive removal • Toolless adapter retention • Illuminated front icons • Rack shelf support or optional rail kit 											
Implementation	Processor uses FC-LGA6 package, two LGA771 sockets													
Memory	2GB, 4GB, or 8GB std, 64GB max, PC2-5300 667MHz DDR2, ECC , fully buffered, 4-channel capable, eight 240-pin DIMM sockets; <i>Non-italics:</i> standard memory in two or four sockets; six or four sockets available	Bay ① 5.25", 1.6" high, external, std optical	Bay ② 5.25", 1.6" high, external, open	Bay ③ 5.25", 1.6" high, external, open	Bay ④ 3.5", 1" high, external, std media reader	Bay ⑤ 3.5", 1" high, internal, std disk	Bay ⑥ 3.5", 1" high, internal, std disk	Bay ⑦ 3.5", 1" high, internal, std or opt disk	Bay ⑧ 3.5", 1" high, internal, std or opt disk	Bay ⑨ 3.5", 1" high, internal, opt disk				
Graphics	Two PCI Express® x16 adapters required for quad monitor support, * 76W to 150W adapters use auxiliary power connector from PSU <i>Some:</i> NVIDIA® Quadro® FX 570 , PCIe 2.0 x16 adapter, 256MB, two dual-link DVI, dual DVI-I or dual VGA, 38W <i>Some:</i> NVIDIA Quadro FX 3700 , PCIe 2.0 x16 adapter, 512MB, two dual-link DVI, dual DVI-I or dual VGA, 78W	Slot 1: half-length, full-height, PCIe x4 (x8 mechanical)	Slot 2: full-length, full-height, PCIe 2.0 x16 (75W* max)	Slot 3: full-length, full-height, PCIe x4 (x8 mechanical)	Slot 4: full-length, full-height, PCIe 2.0 x16 (75W* max)	Slot 5: full-length, full-height, 64-bit PCI-X	Slot 6: full-length, full-height, 64-bit PCI-X	Slot 7: full-length, full-height, 32-bit PCI 2.3						
Media reader	9-in-1 media reader, internal USB 2.0													
SATA disk(s)	<i>Some:</i> 250GB or 500GB , SATA 3.0Gb/s, 7200 rpm													
SATA controller	Serial ATA, SATA 3.0Gb/s, integrated in 6321ESB													
SATA connectors	Five SATA connectors on planar													
SATA DVD±RW	Super Multi-Burner DL DVD±RW SATA 1.5Gb/s (41N5620)													
SAS disk	<i>Some:</i> 146GB , Serial Attached SCSI, 3.0Gb/s, 15000 rpm													
SAS controller	LSI™ LSISAS1068E chipset, 5 connectors, 3.0Gb/s, RAID® 0, 1, 1E													
Chipset	Intel 5400A Chipset , Intel 6321ESB I/O Controller Hub for RAID 0, 1, 5, 10 support, Winbond® W83627EHG Super I/O													
Front ports	Two USB 2.0, microphone (3.5mm), headphone (3.5mm), FireWire 400 (IEEE 1394)													
Rear ports	Four USB 2.0, serial (9-pin), keyboard (PS/2), mouse (PS/2), two ethernet (RJ-45), six analog audio ports (line-in, mic-in, front-out, side-out, rear-out, center/sub-out), RCA-type coaxial digital in, RCA-type coaxial digital out													
IEEE 1394 adpdr	None													
Audio	High Definition (HD) Audio, Realtek® ALC888 codec;													
Speaker	Internal speaker for business audio													
Ethernet	Dual gigabit ethernet on planar, Intel® 82563EB, proprietary Intel bus													
Security chip	Winbond WPCT200 SafeKeeper™ Trusted Platform Module, TCG 1.2-compliant	SECURITY												
Keyboard	Preferred Pro USB Keyboard (USB connector), 104-key, black	<ul style="list-style-type: none"> • Security chip (see information on left) • Side cover lock (ships with two identical keys) • Padlock loop (in rear for opt padlock; padlock prohibits side cover removal) • Security slot (in rear for optional Kensington® Microsaver® cable; prohibits side cover removal) • Power-on password • Administrator password • Boot sequence control • Boot without keyboard, mouse, diskette • Serial port I/O control • USB port disablement (front or all) 												
Mouse	Optical Wheel Mouse (USB connector), black	Supports ThinkVantage® technologies												
Power supply	1000 watts with 120mm bottom-mounted variable speed fan, universal, 80 PLUS®	RoHS-compliant												
Cooling	Five fans (power supply, first processor, second processor, rear, front disk)	<i>Some:</i> ENERGY STAR® 4.0-compliant												
Rack mount	Rack shelf support or optional sliding rack mount rail kit support	LIMITED WARRANTY¹												
Preloaded operating system²⁰	Accessories	<ul style="list-style-type: none"> ↔ 3-year parts and labor ↔ Customer Replaceable Unit (CRU) parts only (with limited onsite service for selected parts³, 8 am - 5 pm, Mon - Fri coverage excluding holidays, next business day response time) ↔ ThinkPlus™ services available; see http://lenovo.com/thinkplus/warranty ↔ 24x7¹⁴ toll-free support for warranty issues during the warranty period¹ via 800-426-7378 												
- Microsoft® Windows® Vista® Business Edition (64-bit)	Intel Xeon Quad-Core Processor E5450	43R2014												
↔ Vista models: Vista Premium logo	2GB PC2-5300 DDR2 ECC FB-DIMM	43R1772												
Preloaded applications⁵	4GB PC2-5300 DDR2 ECC FB-DIMM	43R1773												
• Rescue and Recovery™	750GB SATA 3.0Gb/s Disk (7200 rpm)	43R1991												
• Client Security Solution™	1TB SATA 3.0Gb/s Disk (7200 rpm)	45J7918												
• ThinkVantage Productivity Center	73GB SAS 3.0Gb/s Disk (15000 rpm)	43R1992												
• ThinkVantage System Update	146GB SAS 3.0Gb/s Disk (15000 rpm)	43R1993												
• System Migration Assistant	300GB SAS 3.0Gb/s Disk (15000 rpm)	43R1994												
• Norton Internet Security™ (90 days of virus definitions)	Super Multi-Burner DL DVD±RW SATA1.5Gb/s	41N5620												
• PC-Doctor™ (diagnostics)	Blu-ray Burner / HD-DVD Player SATA 1.5Gb/s	43R1958												
• Adobe® Reader	ThinkStation Rail Kit	43R1964												
• Microsoft Office 2007 Trial (60-day)	USB 2.0 Ultra Secure Memory Key 8GB	45J5918												
• Sonic RecordNow and Drive Letter Access (DVD±RW)	USB 2.0 Portable Secure 320GB Hard Disk	43R2019												
• Corel® WinDVD® (DVD±RW)	ThinkVision® L1940p Wide 19" Monitor	4424HB6												
	ThinkVision L2240p Wide 22" Monitor	4422HB6												
	ThinkVision L2440x Wide 24" Monitor	4421HB2												
	Laser Tilt Wheel Mouse (USB, PS/2)	41U3074												
	Lenovo USB Fingerprint Keyboard	73P4730												
	NVIDIA® Quadro® 512MB FX 570	45J7917												
	NVIDIA Quadro 512MB FX 1700	43R1767												
	NVIDIA Quadro 512MB FX 3700	43R1768												
	NVIDIA Quadro 768MB FX 4600	43R1769												
	Other accessories at lenovo.com/accessories													

See footnotes for important warranty information

ES US models announced September 30, 2008; previous models on August 19, 2008

© Lenovo (BARC11-3) September 2008

Name	Type-model	Slot x bay	Processor(s)	GHz	Memory	Disk(s)	RAID	SATA optical	Graphics adapter(s)	1394 adptr	Sound adptr	ENERGY STAR 4.0	Vista preload	Workhorse Global	Avail date
D10	6493-19U	7x9	1 x E5430	2.66	2 x 1GB	2 x 250GB ²	SATA	DVD±RW	1 x FX1700	None			Bus64	No	Mar 08
D10	6493-21U	7x9	1 x E5440	2.83	2 x 2GB	2 x 146GB	SAS	DVD±RW	1 x FX4600	None		ES40	Bus64	No	Mar 08
D10	6493-22U	7x9	2 x X5460	3.16	2 x 2GB	2 x 146GB	SAS	DVD±RW	1 x FX4600	None			Bus64	No	Mar 08
D10	6493-23U	7x9	1 x E5430	2.66	4 x 1GB	2 x 250GB	SATA	DVD±RW	1 x FX1700	None	X-Fi		Bus64	No	Mar 08
D10	6493-25U	7x9	1 x E5420	2.50	2 x 1GB	2 x 250GB	SATA	DVD±RW	1 x FX1700	None			Bus64	No	Mar 08
D10	6493-26U	7x9	2 x X5460	3.16	4 x 2GB	2 x 146GB	SAS	1 DVD±RW	1 x FX4600	None		ES40	Bus64	No	Mar 08
D10	6493-33U	7x9	2 x X5460	3.16	8 x 2GB	3 x 146GB	SAS	1E DVD±RW	1 x FX4600	None		ES40	Bus64	No	Mar 08
D10	6493-27U	7x9	2 x X5460	3.16	2 x 1GB	2 x 250GB	SATA	1 DVD±RW	2 x NVS290	None		ES40	Bus64	No	Mar 08
D10	6493-31U	7x9	2 x E5440	2.83	2 x 2GB	2 x 146GB	SAS	1 DVD±RW	1 x FX4600	None	X-Fi		Bus64	No	Mar 08
D10	6493-32U	7x9	2 x E5440	2.83	2 x 2GB	3 x 146GB	SAS	1E DVD±RW	1 x FX4600	None	X-Fi		Bus64	No	Mar 08
D10	6493-17U	7x9	2 x E5405	2.00	4 x 1GB	2 x 500GB	SATA	DVD±RW	1 x FX1700	None			Bus64	No	Mar 08
D10	6493-18U	7x9	2 x E5440	2.83	8 x 2GB	4 x 146GB	SAS	0 Blu-ray™	2 x FX4600	None	X-Fi		Bus64	No	Mar 08

- High performance workstation with premium graphics for specialized professionals
- Environmentally friendly, cool, and quiet with rock solid engineering

Processor	One or two processors, Intel® Xeon® processor E5405, E5420, E5430, E5440, or X5460 with quad-core, 1333MHz system bus, and 12MB L2 cache	Tower <ul style="list-style-type: none"> • Raven black color; metal case • 8.3"W x 23.7"D x 17.1"H (without handle) • 210mm W x 602mm D x 434mm H • 65 lb (29.5kg) max configuration • 49-liter • Removable handle on top front • Toolless side cover removal • Toolless disk and optical drive removal • Toolless adapter retention • Illuminated front icons • Rack shelf support or optional rail kit 	
Implementation	Processor uses FC-LGA6 package, two LGA771 sockets		
Memory	2GB, 4GB, 8GB or 16GB std, 64GB max, PC2-5300 667MHz DDR2, ECC , fully buffered, 4-channel capable, eight 240-pin DIMM sockets; <i>Italics:</i> standard memory in eight sockets; no sockets available; <i>Non-italics:</i> standard memory in two or four sockets; six or four sockets available	Bay ① 5.25", 1.6" high, external, std optical Bay ② 5.25", 1.6" high, external, open Bay ③ 5.25", 1.6" high, external, open Bay ④ 3.5", 1" high, external, std media reader Bay ⑤ 3.5", 1" high, internal, std disk Bay ⑥ 3.5", 1" high, internal, std disk Bay ⑦ 3.5", 1" high, internal, std or opt disk Bay ⑧ 3.5", 1" high, internal, std or opt disk Bay ⑨ 3.5", 1" high, internal, opt disk	
Graphics	Two PCI Express® x16 adapters required for quad monitor support, * 76 to 150W adapters use auxiliary power connector from PSU <i>Some:</i> NVIDIA® Quadro® NVS 290 , PCIe x16 adapter, 256MB, two single-link DVI via DMS-59 with dual DVI-I dongle, 21W <i>Some:</i> NVIDIA Quadro FX 1700 , PCIe x16 adapter, 512MB, two dual-link DVI, dual DVI-I or dual VGA, HDTV out, 42W <i>Some:</i> NVIDIA Quadro FX 4600 , PCIe x16 adapter, 768MB, two slot width, 2 dual-link DVI, dual DVI-I or dual VGA, 134W	Slot 1: half-length, full-height, PCIe x4 (x8 mechanical) Slot 2: full-length, full-height, PCIe 2.0 x16 (75W* max) Slot 3: full-length, full-height, PCIe x4 (x8 mechanical) Slot 4: full-length, full-height, PCIe 2.0 x16 (75W* max) Slot 5: full-length, full-height, 64-bit PCI-X Slot 6: full-length, full-height, 64-bit PCI-X Slot 7: full-length, full-height, 32-bit PCI 2.3	
Media reader	9-in-1 media reader, internal USB 2.0		
SATA disk(s)	<i>Some:</i> 250GB or 500GB , SATA 3.0Gb/s, 7200 rpm		
SATA controller	Serial ATA, SATA 3.0Gb/s, integrated in 6321ESB		
SATA connectors	Five SATA connectors on planar		
SATA DVD±RW	<i>Some:</i> Super Multi-Burner DL DVD±RW SATA 1.5Gb/s (41N5620)		
SATA Blu-ray	<i>Some:</i> Blu-ray Burner, SATA 1.5Gb/s (43R1958) HD-DVD Player		
SAS disk	<i>Some:</i> 146GB , Serial Attached SCSI, 3.0Gb/s, 15000 rpm		
SAS controller	LSI™ LSI SAS1068E chipset, 5 connectors, 3.0Gb/s, RAID® 0, 1, 1E		
Chipset	Intel 5400A Chipset , Intel 6321ESB I/O Controller Hub for RAID 0, 1, 5, 10 support, Winbond® W83627EHG Super I/O		
Front ports	Two USB 2.0, microphone (3.5mm), headphone (3.5mm), FireWire 400 (IEEE 1394)		
Rear ports	Four USB 2.0, serial (9-pin), keyboard (PS/2), mouse (PS/2), two ethernet (RJ-45), six analog audio ports (line-in, mic-in, front-out, side-out, rear-out, center/sub-out), RCA-type coaxial digital in, RCA-type coaxial digital out		
IEEE 1394 adptr	None		
Audio	High Definition (HD) Audio, Realtek® ALC888 codec; <i>Some:</i> Creative Sound Blaster® X-Fi, PCI adapter, high-end sound adapter		
Speaker	Internal speaker for business audio		
Ethernet	Dual gigabit ethernet on planar, Intel® 82563EB, proprietary Intel bus		
Security chip	Winbond WPCT200 SafeKeeper™ Trusted Platform Module, TCG 1.2-compliant	SECURITY <ul style="list-style-type: none"> • Security chip (see information on left) • Side cover lock (ships with two identical keys) • Padlock loop (in rear for opt padlock; padlock prohibits side cover removal) • Security slot (in rear for optional Kensington® Microsaver® cable; prohibits side cover removal) • Power-on password • Administrator password • Boot sequence control • Boot without keyboard, mouse, diskette • Serial port I/O control • USB port disablement (front or all) 	
Keyboard	<i>Model 18U:</i> Lenovo USB Fingerprint Keyboard (USB connector), black Preferred Pro USB Keyboard (USB connector), 104-key, black		
Mouse	Optical Wheel Mouse (USB connector), black		
Power supply	1000 watts with 120mm bottom-mounted variable speed fan, universal, 80 PLUS®		
Cooling	Five fans (power supply, first processor, second processor, rear, front disk)		
Rack mount	Rack shelf support or optional sliding rack mount rail kit support		

Preloaded operating system²⁰ - Microsoft® Windows® Vista® Business Edition (64-bit) ♦ Vista Premium logo Preloaded applications⁵ (only some listed)	Accessories Intel Xeon Quad-Core Processor E5420 43R2011 Intel Xeon Quad-Core Processor E5430 43R2012 Intel Xeon Quad-Core Processor E5440 43R2013 2GB PC2-5300 DDR2 ECC FB-DIMM 43R1772 4GB PC2-5300 DDR2 ECC FB-DIMM 43R1773 750GB SATA 3.0Gb/s Disk (7200 rpm) 43R1991 1TB SATA 3.0Gb/s Disk (7200 rpm) 45J7918 146GB SAS 3.0Gb/s Disk (15000 rpm) 43R1993 300GB SAS 3.0Gb/s Disk (15000 rpm) 43R1994 Blu-ray Burner / HD-DVD Player SATA 1.5Gb/s 43R1958 ThinkStation Rail Kit 43R1964 USB 2.0 Ultra Secure Memory Key 8GB 45J5918 USB 2.0 Portable Secure 320GB Hard Disk 43R2019 ThinkVision® L2440p Wide 24" Monitor 4420HB2 NVIDIA® Quadro® 512MB FX 1700 43R1767 NVIDIA Quadro 512MB FX 3700 43R1768 Other accessories at lenovo.com/accessories	Supports ThinkVantage® technologies RoHS-compliant <i>Some:</i> ENERGY STAR® 4.0-compliant LIMITED WARRANTY¹ ⇨ 3-year parts and labor ⇨ Customer Replaceable Unit (CRU) parts only (with limited onsite service for selected parts ³ , 8 am - 5 pm, Mon - Fri coverage excluding holidays, next business day response time) ⇨ ThinkPlus™ services available; see http://lenovo.com/thinkplus/warranty • Onsite service upgrade options (in eligible locations) ⁷ ⇨ 24x7 ¹⁴ toll-free support for warranty issues during the warranty period ¹ via 800-426-7378
--	---	---

See footnotes for important warranty information
 US models announced March 11, 2008

Name	Type-model	Slot x bay	Processor(s)	GHz	Memory	Disk(s)	RAID	SATA optical	Graphics adapter(s)	1394 adpdr	Sound adpdr	ENERGY STAR 4.0	Vista preload	Workhorse Global	Avail date
D10	6493-34U	7x9	1 x E5430	2.66	2 x 1GB	1 x 250GB ² SATA		DVD±RW	1 x FX1700	None	None	Pending	XP Pro	No	Apr 08
D10	6493-39U	7x9	1 x E5430	2.66	2 x 1GB	1 x 146GB SAS		DVD±RW	1 x FX1700	None	None	Pending	XP Pro	No	Apr 08
D10	6493-35U	7x9	1 x E5450	3.00	2 x 1GB	1 x 250GB SATA		DVD±RW	1 x FX1700	None	None	Pending	XP Pro	No	Apr 08
D10	6493-41U	7x9	1 x E5450	3.00	2 x 1GB	1 x 146GB SAS		DVD±RW	1 x FX1700	None	None	Pending	XP Pro	No	Apr 08
D10	6493-36U	7x9	1 x X5460	3.16	2 x 1GB	2 x 250GB SATA		DVD±RW	1 x FX4600	None	None	Pending	XP Pro	No	Apr 08
D10	6493-42U	7x9	1 x X5460	3.16	2 x 1GB	2 x 146GB SAS		DVD±RW	1 x FX4600	None	None	Pending	XP Pro	No	Apr 08
D10	6493-45U	7x9	1 x X5460	3.16	2 x 1GB	4 x 250GB SATA	5	DVD±RW	1 x FX4600	None	None	Pending	XP Pro	No	Apr 08
D10	6493-37U	7x9	2 x E5450	3.00	2 x 1GB	2 x 250GB SATA		DVD±RW	1 x FX4600	None	None	Pending	XP Pro	No	Apr 08
D10	6493-43U	7x9	2 x E5450	3.00	2 x 1GB	2 x 146GB SAS		DVD±RW	1 x FX4600	None	None	Pending	XP Pro	No	Apr 08
D10	6493-46U	7x9	2 x E5450	3.00	2 x 1GB	4 x 250GB SATA	5	DVD±RW	1 x FX4600	None	None	Pending	XP Pro	No	Apr 08
D10	6493-38U	7x9	2 x X5460	3.16	2 x 1GB	2 x 250GB SATA		DVD±RW	1 x FX4600	None	None	Pending	XP Pro	No	Apr 08
D10	6493-44U	7x9	2 x X5460	3.16	2 x 1GB	2 x 146GB SAS		DVD±RW	1 x FX4600	None	None	Pending	XP Pro	No	Apr 08
D10	6493-47U	7x9	2 x X5460	3.16	2 x 1GB	4 x 250GB SATA	5	DVD±RW	1 x FX4600	None	None	Pending	XP Pro	No	Apr 08

- High performance workstation with premium graphics for specialized professionals
- Environmentally friendly, cool, and quiet with rock solid engineering

Processor	One or two processors, Intel® Xeon® processor E5430, E5450, or X5460 with quad-core, 1333MHz system bus, and 12MB L2 cache	<p>Tower</p> <ul style="list-style-type: none"> • Raven black color; metal case • 8.3"W x 23.7"D x 17.1"H (without handle) • 210mm W x 602mm D x 434mm H • 65 lb (29.5kg) max configuration • 49-liter • Removable handle on top front • Toolless side cover removal • Toolless disk and optical drive removal • Toolless adapter retention • Illuminated front icons • Rack shelf support or optional rail kit 
Implementation	Processor uses FC-LGA6 package, two LGA771 sockets	
Memory	2GB std, 64GB max, PC2-5300 667MHz DDR2, ECC , fully buffered, 4-channel capable, eight 240-pin DIMM sockets; <i>Non-italics:</i> standard memory in two sockets; six sockets available	
Graphics	Two PCI Express® x16 adapters required for quad monitor support, * 76 to 150W adapters use auxiliary power connector from PSU <i>Some:</i> NVIDIA® Quadro® FX 1700 , PCIe x16 adapter, 512MB, two dual-link DVI, dual DVI-I or dual VGA, HDTV out, 42W <i>Some:</i> NVIDIA Quadro FX 4600 , PCIe x16 adapter, 768MB, two slot width, 2 dual-link DVI, dual DVI-I or dual VGA, 134W	
Media reader	9-in-1 media reader, internal USB 2.0	
SATA disk(s)	<i>Some:</i> 250GB , SATA 3.0Gb/s, 7200 rpm	
SATA controller	Serial ATA, SATA 3.0Gb/s, integrated in 6321ESB	
SATA connectors	Five SATA connectors on planar	
SATA DVD±RW	Super Multi-Burner DL DVD±RW SATA 1.5Gb/s Drive	
SATA Blu-ray	None	
SAS disk	<i>Some:</i> 146GB , Serial Attached SCSI, 3.0Gb/s, 15000 rpm	
SAS controller	LSI™ LSISAS1068E chipset, 5 connectors, 3.0Gb/s, RAID® 0, 1, 1E	
Chipset	Intel 5400A Chipset , Intel 6321ESB I/O Controller Hub for RAID 0, 1, 5, 10 support, Winbond® W83627EHG Super I/O	
Front ports	Two USB 2.0, microphone (3.5mm), headphone (3.5mm), FireWire 400 (IEEE 1394)	
Rear ports	Four USB 2.0, serial (9-pin), keyboard (PS/2), mouse (PS/2), two ethernet (RJ-45), six analog audio ports (line-in, mic-in, front-out, side-out, rear-out, center/sub-out), RCA-type coaxial digital in, RCA-type coaxial digital out	
IEEE 1394 adpdr	None	
Audio	High Definition (HD) Audio, Realtek® ALC888 codec;	
Speaker	Internal speaker for business audio	
Ethernet	Dual gigabit ethernet on planar, Intel® 82563EB, proprietary Intel bus	
Security chip	Winbond WPCT200 SafeKeeper™ Trusted Platform Module, TCG 1.2-compliant	
Keyboard	Preferred Pro USB Keyboard (USB connector), 104-key, black	
Mouse	Optical Wheel Mouse (USB connector), black	
Power supply	1000 watts with 120mm bottom-mounted variable speed fan, universal, 80 PLUS®	
Cooling	Five fans (power supply, first processor, second processor, rear, front disk)	
Rack mount	Rack shelf support or optional sliding rack mount rail kit support	
Preloaded operating system²⁰	Accessories	
- Microsoft® Windows® XP Professional	Intel Xeon Quad-Core Processor E5430	43R2012
Preloaded applications⁵	Intel Xeon Quad-Core Processor E5450	43R2014
• Rescue and Recovery™	2GB PC2-5300 DDR2 ECC FB-DIMM	43R1772
• Client Security Solution™	4GB PC2-5300 DDR2 ECC FB-DIMM	43R1773
• ThinkVantage Productivity Center	750GB SATA 3.0Gb/s Disk (7200 rpm)	43R1991
• ThinkVantage System Update	1TB SATA 3.0Gb/s Disk (7200 rpm)	45J7918
• System Migration Assistant	146GB SAS 3.0Gb/s Disk (15000 rpm)	43R1993
• Norton Internet Security™	300GB SAS 3.0Gb/s Disk (15000 rpm)	43R1994
(90 days of virus definitions)	Super Multi-Burner DL DVD±RW SATA 1.5Gb/s	41N5620
• PC-Doctor™ (diagnostics)	Blu-ray Burner / HD-DVD Player SATA 1.5Gb/s	43R1958
• Windows Live™ Toolbar	ThinkStation Rail Kit	43R1964
• Windows Live Search	USB 2.0 Ultra Secure Memory Key 8GB	45J5918
• Sonic RecordNow and	USB 2.0 Portable Secure 320GB Hard Disk	43R2019
Drive Letter Access (DVD±RW)	ThinkVision® L2240p Wide 22" Monitor	4422HB6
• Corel® WinDVD® (DVD±RW)	ThinkVision L2440x Wide 24" Monitor	4421HB2
	Kensington® Cable Lock from Lenovo	73P2582
	Laser Tilt Wheel Mouse (USB, PS/2)	41U3074
	Lenovo USB Fingerprint Keyboard	73P4730
	NVIDIA® Quadro® 512MB FX 570	45J7917
	NVIDIA Quadro 512MB FX 1700	43R1767
	NVIDIA Quadro 512MB FX 3700	43R1768
	Other accessories at lenovo.com/accessories	
		<p>SECURITY</p> <ul style="list-style-type: none"> • Security chip (see information on left) • Side cover lock (ships with two identical keys) • Padlock loop (in rear for opt padlock; padlock prohibits side cover removal) • Security slot (in rear for optional Kensington® Microsaver® cable; prohibits side cover removal) • Power-on password • Administrator password • Boot sequence control • Boot without keyboard, mouse, diskette • Serial port I/O control • USB port disablement (front or all) <p>Supports ThinkVantage® technologies</p> <p>RoHS-compliant <i>Pending:</i> ENERGY STAR® 4.0-compliant</p> <p>LIMITED WARRANTY¹</p> <ul style="list-style-type: none"> ↔ 3-year parts and labor ↔ Customer Replaceable Unit (CRU) parts only (with limited onsite service for selected parts³, 8 am - 5 pm, Mon - Fri coverage excluding holidays, next business day response time) ↔ ThinkPlus™ services available; see http://lenovo.com/thinkplus/warranty ↔ 24x7¹⁴ toll-free support for warranty issues during the warranty period¹ via 800-426-7378

See footnotes for important warranty information
US models announced April 22, 2008

Name	Type-model	Slot x bay	Processor(s)	GHz	Memory	Disk(s)	RAID	SATA optical	Graphics adapter(s)	1394 adptry	Sound adptry	ENERGY STAR 4.0	Preload	Avail date
D10	6493-73U	7x9	2 x E5450	3.00	4 x 1GB	2 x 250GB	SATA	None	DVD±RW	1 x FX3700	None	None	Pending	Bus64 Aug 08
D10	6493-A2U	7x9	2 x E5450	3.00	4 x 1GB	2 x 250GB	SATA	None	DVD±RW	1 x FX1700	None	None	Pending	Bus64 Aug 08

- **High performance workstation with premium graphics for specialized professionals**
- **Environmentally friendly, cool, and quiet with rock solid engineering**
- **These small and medium business (SMB) models are part of the US TopSeller™ Program**

Processor(s)	Two processors, Intel® Xeon® processor E5450 with quad-core, 1333MHz system bus, and 12MB L2 cache		Processor Processor uses FC-LGA6 package, two LGA771 sockets	Power • Raven black color; metal case • 8.3"W x 23.7"D x 17.1"H (without handle) • 210mm W x 602mm D x 434mm H • 65 lb (29.5kg) max configuration • 49-liter • Removable handle on top front • Toolless side cover removal • Toolless disk and optical drive removal • Toolless adapter retention • Illuminated front icons • Rack shelf support or optional rail kit	
Implementation	Processor uses FC-LGA6 package, two LGA771 sockets				
Memory	4GB std, 64GB max, PC2-5300 667MHz DDR2 , ECC, fully buffered, 4-channel capable, eight 240-pin DIMM sockets; <i>Non-italics:</i> standard memory in two or four sockets; six or four sockets available		Graphics Two PCI Express® x16 adapters required for quad monitor support, * 76 to 150W adapters use auxiliary power connector from PSU <i>Some:</i> NVIDIA® Quadro® FX 1700 , PCIe x16 adapter, 512MB, two dual-link DVI, dual DVI-I or dual VGA, HDTV out, 42W <i>Some:</i> NVIDIA Quadro FX 3700 , PCIe 2.0 x16 adapter, 512MB, two dual-link DVI, dual DVI-I or dual VGA, 78W		
Graphics	Two PCI Express® x16 adapters required for quad monitor support, * 76 to 150W adapters use auxiliary power connector from PSU <i>Some:</i> NVIDIA® Quadro® FX 1700 , PCIe x16 adapter, 512MB, two dual-link DVI, dual DVI-I or dual VGA, HDTV out, 42W <i>Some:</i> NVIDIA Quadro FX 3700 , PCIe 2.0 x16 adapter, 512MB, two dual-link DVI, dual DVI-I or dual VGA, 78W				
Media reader	9-in-1 media reader, internal USB 2.0		Media Bay ① 5.25", 1.6" high, external, std optical Bay ② 5.25", 1.6" high, external, open Bay ③ 5.25", 1.6" high, external, open Bay ④ 3.5", 1" high, external, std media reader Bay ⑤ 3.5", 1" high, internal, std disk Bay ⑥ 3.5", 1" high, internal, std disk Bay ⑦ 3.5", 1" high, internal, std or opt disk Bay ⑧ 3.5", 1" high, internal, std or opt disk Bay ⑨ 3.5", 1" high, internal, opt disk		
SATA disk(s)	250GB , SATA 3.0Gb/s, 7200 rpm Serial ATA, SATA 3.0Gb/s, integrated in 6321ESB				
SATA controller	Five SATA connectors on planar		Slot Slot 1: half-length, full-height, PCIe x4 (x8 mechanical) Slot 2: full-length, full-height, PCIe 2.0 x16 (75W* max) Slot 3: full-length, full-height, PCIe x4 (x8 mechanical) Slot 4: full-length, full-height, PCIe 2.0 x16 (75W* max) Slot 5: full-length, full-height, 64-bit PCI-X Slot 6: full-length, full-height, 64-bit PCI-X Slot 7: full-length, full-height, 32-bit PCI 2.3		
SATA connectors	Super Multi-Burner DL DVD±RW SATA 1.5Gb/s (41N5620)				
SATA DVD±RW	None		SECURITY • Security chip (see information on left) • Side cover lock (ships with two identical keys) • Padlock loop (in rear for opt padlock; padlock prohibits side cover removal) • Security slot (in rear for optional Kensington® Microsaver® cable; prohibits side cover removal) • Power-on password • Administrator password • Boot sequence control • Boot without keyboard, mouse, diskette • Serial port I/O control • USB port disablement (front or all)		
SAS disk	None				
SAS controller	LSI™ LSISAS1068E chipset, 5 connectors, 3.0Gb/s, RAID® 0, 1, 1E		Supports ThinkVantage® technologies RoHS-compliant Some: ENERGY STAR® 4.0-compliant		
Chipset	Intel 5400A Chipset , Intel 6321ESB I/O Controller Hub for RAID 0, 1, 5, 10 support, Winbond® W83627EHG Super I/O				
Front ports	Two USB 2.0, microphone (3.5mm), headphone (3.5mm), FireWire 400 (IEEE 1394)		LIMITED WARRANTY¹ ⇨ 3-year parts and labor ⇨ Customer Replaceable Unit (CRU) parts only (with limited onsite service for selected parts³, 8 am - 5 pm, Mon - Fri coverage excluding holidays, next business day response time) ⇨ ThinkPlus™ services available; see http://lenovo.com/thinkplus/warranty ⇨ 24x7¹⁴ toll-free support for warranty issues during the warranty period¹ via 800-426-7378		
Rear ports	Four USB 2.0, serial (9-pin), keyboard (PS/2), mouse (PS/2), two ethernet (RJ-45), six analog audio ports (line-in, mic-in, front-out, side-out, rear-out, center/sub-out), RCA-type coaxial digital in, RCA-type coaxial digital out				
IEEE 1394 adptry	None		Other accessories at lenovo.com/accessories		
Audio	High Definition (HD) Audio, Realtek® ALC888 codec;				
Speaker	Internal speaker for business audio		Preloaded operating system²⁰ - Microsoft® Windows® Vista® Business Edition (64-bit) ⇨ <i>Vista models:</i> Vista Premium logo Preloaded applications⁵ • Rescue and Recovery™ • Client Security Solution™ • ThinkVantage Productivity Center • ThinkVantage System Update • System Migration Assistant • Norton Internet Security™ (90 days of virus definitions) • PC-Doctor™ (diagnostics) • Adobe® Reader • Microsoft Office 2007 Trial (60-day) • Sonic RecordNow and Drive Letter Access (DVD±RW) • Corel® WinDVD® (DVD±RW)		
Ethernet	Dual gigabit ethernet on planar, Intel® 82563EB, proprietary Intel bus				
Security chip	Winbond WPCT200 SafeKeeper™ Trusted Platform Module, TCG 1.2-compliant				
Keyboard	Preferred Pro USB Keyboard (USB connector), 104-key, black				
Mouse	Optical Wheel Mouse (USB connector), black				
Power supply	1000 watts with 120mm bottom-mounted variable speed fan, universal, 80 PLUS®				
Cooling	Five fans (power supply, first processor, second processor, rear, front disk)				
Rack mount	Rack shelf support or optional sliding rack mount rail kit support				

See footnotes for important warranty information
 US models announced August 19, 2008

Partial list of accessories supported on ThinkStation S10 and D10

Processors

D10:

Intel® Xeon® Quad-Core Processor E5405	43R2009	ann 07/29/08
Intel Xeon Quad-Core Processor E5410	43R2010	ann 07/29/08
Intel Xeon Quad-Core Processor E5420	43R2011	ann 07/29/08
Intel Xeon Quad-Core Processor E5430	43R2012	ann 07/29/08
Intel Xeon Quad-Core Processor E5440	43R2013	ann 07/29/08
Intel Xeon Quad-Core Processor E5450	43R2014	ann 07/29/08
Intel Xeon Quad-Core Processor E5460	43R2016	ann 07/29/08

Memory

S10:

1GB PC3-8500 DDR3 ECC UDIMM	41U5251	ann 12/18/07
2GB PC3-8500 DDR3 ECC UDIMM	41U5252	ann 12/18/07

D10 (install in pairs only):

1GB PC2-5300 DDR2 ECC FB-DIMM	43R1771	ann 03/11/08
2GB PC2-5300 DDR2 ECC FB-DIMM	43R1772	ann 03/11/08
4GB PC2-5300 DDR2 ECC FB-DIMM	43R1773	ann 03/11/08

Optical

DVD-ROM DL SATA1.5Gb/s 16X-48X Max ⁴	41N5618	ann 09/26/06
Super Multi-Burner DL DVD±RW SATA1.5Gb/s	41N5620	ann 09/26/06
Blu-ray Burner / HD-DVD Player SATA1.5Gb/s	43R1958	ann 12/18/07

Storage and removable storage

S10 or D10 preconfigured with SATA disks:

160GB SATA 3.0Gb/s Disk (7200 rpm)	09N4254	ann 05/19/03
250GB SATA 3.0Gb/s Disk (7200 rpm)	41N3015	ann 01/24/06
500GB SATA 3.0Gb/s Disk (7200 rpm)	43R1990	ann 11/06/07
750GB SATA 3.0Gb/s Disk (7200 rpm)	43R1991	ann 12/18/07
1TB SATA 3.0Gb/s Disk (7200 rpm)	45J7918	ann 08/19/08

*S10 preconfigured with SAS disks and the SAS controller,
D10 preconfigured with SAS disks:*

73GB SAS 3.0Gb/s Disk (15000 rpm)	43R1992	ann 03/11/08
146GB SAS 3.0Gb/s Disk (15000 rpm)	43R1993	ann 03/11/08
300GB SAS 3.0Gb/s Disk (15000 rpm)	43R1994	ann 03/11/08

All:

USB Portable Diskette Drive	05K9276	ann 06/05/00
USB 2.0 Essential Memory Key 4GB	45J7904	ann 06/24/08
USB 2.0 Essential Memory Key 8GB	45J7905	ann 07/15/08
USB 2.0 Essential Memory Key 32GB	45K1258	ann 10/28/08
USB 2.0 Security Memory Key 4GB	41U5120	ann 07/17/07
USB 2.0 Ultra Secure Memory Key 2GB	45J5916	ann 08/26/08
USB 2.0 Ultra Secure Memory Key 4GB	45J5917	ann 08/26/08
USB 2.0 Ultra Secure Memory Key 8GB	45J5918	ann 08/26/08

All:

USB 2.0 CD-RW/DVD-ROM Combo II Drive	40Y8637	
USB 2.0 Portable 160GB Hard Disk	43R1784	ann 09/23/08
USB 2.0 Portable Secure 160GB Hard Disk	43R2018	ann 11/18/08
USB 2.0 Portable Secure 320GB Hard Disk	43R2019	ann 11/18/08
USB 2.0 Super Multi-Burner Drive	41N5565	ann 01/23/07

Graphics

NVIDIA® Quadro® 256MB NVS 290	43R1765	ann 12/18/07
NVIDIA Quadro 256MB FX 370	43R1766	ann 12/18/07
NVIDIA Quadro 256MB FX 570	45J7917	ann 08/19/08
NVIDIA Quadro 512MB FX 1700	43R1767	ann 12/18/07
NVIDIA Quadro 512MB FX 3700	43R1768	ann 08/19/08
NVIDIA Quadro 768MB FX 4600	43R1769	ann 12/18/07

More information at www.lenovo.com/support/graphiccards

Keyboard

Preferred Pro USB Keyboard	73P5220	ann 06/21/05
Enhanced Performance USB Keyboard	73P2620	ann 03/23/04
Wireless Kybd & Opt Wheel Mouse (via USB)	73P4067	ann 12/07/04
Lenovo USB Fingerprint Keyboard	73P4730	ann 02/22/05

More information at www.lenovo.com/support/keyboards

Mouse

Optical Wheel Mouse (USB)	06P4069	ann 05/21/03
Optical ScrollPoint® Mouse (USB, PS/2)	31P7405	ann 08/27/02
Laser Tilt Wheel Mouse (USB, PS/2)	41U3074	ann 01/23/07
Lenovo Wireless Laser Mouse (blk, via USB)	45K1696	ann 11/25/08
Lenovo Wireless Laser Mouse (red, via USB)	51J0198	ann 11/25/08

More information at www.lenovo.com/support/mice

Monitors

ThinkVision® L174 17" Monitor	9227AE1	ann 04/15/08
ThinkVision L1700p 17" Monitor	9417HE2	ann 09/17/08
ThinkVision L1900p 19" Monitor	4431HE1	ann 11/11/08
ThinkVision L1940p Wide 19" Monitor	4424HB6	ann 09/17/08
ThinkVision L200p Wide 20.1" Monitor	4438HB6	ann 04/15/08
ThinkVision L2240p Wide 22" Monitor	4422HB6	ann 09/17/08
ThinkVision L2440p Wide 24" Monitor	4420HB2	ann 09/17/08
ThinkVision L2440x Wide 24" Monitor	4421HB2	ann 09/17/08

More information at www.lenovo.com/thinkvision

Monitor accessories⁴⁶

ThinkVision USB Soundbar	40Y7616	ann 08/23/05
ThinkVision Soundbar	45K1263	ann 09/16/08
Kensington® Cable Lock from Lenovo	73P2582	ann 12/29/03
Kensington Twin Head Cable Lock	45K1620	ann 09/30/08
Radial Arm	19K4464	ann 05/05/00

⁴⁶Compatible on selected Lenovo and ThinkVision monitors.

More information at www.lenovo.com/support/monitoraccessories

Multimedia

USB 2.0 Lenovo Multimedia Headset	40Y8518	ann 06/27/06
USB 2.0 Lenovo Webcam	40Y8519	ann 08/29/06

Security

Kensington Cable Lock from Lenovo	73P2582	ann 12/29/03
Kensington Twin Head Cable Lock	45K1620	ann 09/30/08
USB Gemplus GemPC Smart Card Reader	41N3040	ann 02/21/06

Rack mount accessories

D10:

ThinkStation Rail Kit	43R1964	ann 03/11/08
-----------------------	---------	--------------

More information at www.lenovo.com/support/railkit

Medialess License Key (MLK)

Microsoft® Office 2007 Basic, English	43R1528	ann 01/31/07
Microsoft Office 2007 Small Business, Engl	43R1534	ann 01/31/07
Microsoft Office 2007 Professional, English	43R1531	ann 01/31/07

Other accessories at www.lenovo.com/accessories

Accessories Guide pdf at www.lenovo.com/accessoriesguide

Partial list of Lenovo® ThinkPlus Services⁷ for ThinkStation workstations

For more information see:

http://www.lenovo.com/services_warranty/us/en/index.html

<p><u>ThinkPlus service upgrade options</u></p> <p><i>ThinkStation workstation with 3-year Onsite warranty</i> <i>LOR = Lenovo Onsite Repair</i></p> <table border="0"> <tr> <td>4-year LOR 9x5 Next Business Day</td> <td>43R8983</td> </tr> <tr> <td>5-year LOR 9x5 Next Business Day</td> <td>43R8987</td> </tr> </table>	4-year LOR 9x5 Next Business Day	43R8983	5-year LOR 9x5 Next Business Day	43R8987	<p><u>ThinkPlus Priority Support for enterprise customers</u></p> <ul style="list-style-type: none"> • 9x5 next-business-day response Lenovo Onsite Repair • 24x7 support with priority routing and advanced level technicians <p><i>ThinkStation workstation with 1-year Onsite warranty</i></p> <table border="0"> <tr> <td>3-year Priority Support</td> <td>45J9080</td> </tr> </table> <p><i>ThinkStation workstation with 3-year Onsite warranty</i></p> <table border="0"> <tr> <td>3-year Priority Support</td> <td>45J9081</td> </tr> <tr> <td>4-year Priority Support</td> <td>45J9082</td> </tr> <tr> <td>5-year Priority Support</td> <td>45J9083</td> </tr> <tr> <td>3-year Priority Support 4-hour response</td> <td>45J9084</td> </tr> <tr> <td>4-year Priority Support 4-hour response</td> <td>45J9085</td> </tr> <tr> <td>5-year Priority Support 4-hour response</td> <td>45J9086</td> </tr> </table>	3-year Priority Support	45J9080	3-year Priority Support	45J9081	4-year Priority Support	45J9082	5-year Priority Support	45J9083	3-year Priority Support 4-hour response	45J9084	4-year Priority Support 4-hour response	45J9085	5-year Priority Support 4-hour response	45J9086
4-year LOR 9x5 Next Business Day	43R8983																		
5-year LOR 9x5 Next Business Day	43R8987																		
3-year Priority Support	45J9080																		
3-year Priority Support	45J9081																		
4-year Priority Support	45J9082																		
5-year Priority Support	45J9083																		
3-year Priority Support 4-hour response	45J9084																		
4-year Priority Support 4-hour response	45J9085																		
5-year Priority Support 4-hour response	45J9086																		
<p><u>ThinkPlus Secure Business</u></p> <p><i>Lenovo Online Data Backup</i></p> <ul style="list-style-type: none"> • Secure offsite data storage • 256-bit Advanced Encryption System • Data recovery or access in case of an unforeseen event • Automatic, remote management • Choose which business critical data to back up <table border="0"> <tr> <td>1-year Lenovo Online Data Backup - <i>50GB</i></td> <td>45K5849</td> </tr> <tr> <td>1-year Lenovo Online Data Backup - <i>Unlimited</i></td> <td>45K5870</td> </tr> </table>	1-year Lenovo Online Data Backup - <i>50GB</i>	45K5849	1-year Lenovo Online Data Backup - <i>Unlimited</i>	45K5870															
1-year Lenovo Online Data Backup - <i>50GB</i>	45K5849																		
1-year Lenovo Online Data Backup - <i>Unlimited</i>	45K5870																		

Availability: All offers subject to availability. Lenovo reserves the right to alter product offerings and specifications at any time, without notice. Lenovo is not responsible for photographic or typographic errors.

Warranty: For a copy of applicable product warranties, write to: Warranty Information, 500 Park Offices Drive, RTP, NC, 27709, Attn: Dept ZPYA/B600. Lenovo makes no representation or warranty regarding third party products or services.

¹ **Limited warranty:** Support unrelated to a warranty issue may be subject to additional charges.

² **Hard drive:** GB = billion bytes, TB = trillion bytes. Accessible capacity is less.

³ **Systems with limited onsite service** are designed to be repaired during the applicable warranty period primarily with customer-replaceable parts provided by Lenovo. Lenovo will only send a technician onsite to perform a repair if (a) remote telephone diagnosis and/or customer part replacement are unable to resolve the problem, or (b) the part is one of the few designated by Lenovo for onsite replacement. For a list of onsite replaceable parts, contact Lenovo. In the United States call 1-800-426-7378. Support unrelated to a warranty issue may be subject to additional charges.

⁵ **Included software** may differ from its retail version (if available), and may not include user manuals or all program functionality. License agreements may apply.

⁶ **Multi-Burner Plus** (part number 73P3305 or 73P3370) is a DVD±RW device that reads and writes to DVD-RAM, DVD-R, DVD-RW, DVD+R, and DVD+RW. It also reads and writes to CD-R and CD-RW media. 73P3370 also writes to DVD+R double layer media.

⁷ **ThinkPlus Services:** These services are available for machines normally used for business, professional, or trade purposes, rather than personal, family, or household purposes. Not all machine types and models are covered. Service period begins with the equipment date of purchase. Service must be purchased during the original limited product warranty period. Service levels are response time objectives and are not guarantees. If the machine problem turns out to be a Customer Replaceable Unit (CRU), a part will be express shipped to you for quick replacement. Onsite 24x7x2-hour service is not available in all locations. P&L means parts and labor. P/U means pick-up. See ThinkPlus terms and conditions for complete details and restrictions.

⁸ **RAID:** Supported RAID levels for a system will vary from the stated capabilities of the RAID controller due to dependencies on the number and capacity of physical disks in the system and on customer requirements for performance, fault tolerance, or data redundancy.

RAID levels and requirements:

- **RAID 0 (striping)** provides increased performance by writing data across multiple drives.
- **RAID 1 (mirroring)** provides fault tolerance by writing the data on two drives.
- **RAID 5 (striping with parity)** uses distributed parity data to provide fault tolerance more efficiently than RAID 1. Requires three or more drives.
- **RAID 10 (or RAID 1+0)** combines RAID 1 and RAID 0 to create a stripe of mirrors that is fault tolerant while offering increased performance. Requires four drives.

⁹ **International Warranty Service** is available in any country in which this product is sold and serviced. Service delivery methods and parts availability vary by country, may be different from that in the country of purchase, and are subject to change without notice. Fees and restrictions may apply in some countries.

¹⁴ **Response times may vary.** May exclude some holidays. Telephone support may be subject to additional charges.

²⁰ **Operating System:** Level of support varies by operating system. Operating systems not preloaded on the system may not provide full feature functionality. Refer to lenovo.com/pc/support and enter your machine type and model number for more information.

ThinkStation

This publication was developed for products and services offered in the United States. Lenovo may not offer the products, services or features discussed in this document in other countries. Lenovo may withdraw an offering at any time. Information is subject to change without notice. Consult your local representative for information on offerings available in your area.

Lenovo reserves the right to change specifications and other product information at any time without prior notice. Lenovo is not responsible for photographic or typographical errors. LENOVO PROVIDES THIS PUBLICATION "AS IS" WITHOUT WARRANTY OF ANY KIND, EITHER EXPRESS OR IMPLIED, INCLUDING THE IMPLIED WARRANTIES OF MERCHANTABILITY OR FITNESS FOR A PARTICULAR PURPOSE. Some jurisdictions do not allow disclaimer of express or implied warranties in certain transactions; therefore this disclaimer may not apply to you.

Trademarks: Lenovo, the Lenovo logo, New World. New Thinking., Access Connections, Rescue and Recovery, ThinkCentre, ThinkPad, ThinkServer, ThinkStation, ThinkVantage, and ThinkVision are trademarks of Lenovo. Microsoft, Windows, and Vista are registered trademarks of Microsoft Corporation. Intel, the Intel logo, Intel Inside logo, Intel Core and Core Inside are trademarks of Intel Corporation in the US and other countries. Other company, product, or service names may be trademarks or service marks of others.

Visit lenovo.com/safecomputing periodically for the latest information on safe and effective computing.

© Lenovo, 2008.
All rights reserved.

Lenovo
1009 Think Place
Morrisville, NC 27560
U.S.A.

December 2008
tsbook.pdf

ThinkServer™

Personal Systems Reference Lenovo ThinkServer Servers

December 2008 - Version 349



lenovo.com



Lenovo ThinkServer TS100
with 400W non-redundant power supply



Lenovo ThinkServer TS100
with simple-swap disks



Lenovo ThinkServer TS100
with 430W redundant power supply



Lenovo ThinkServer TS100



Lenovo ThinkServer TS100

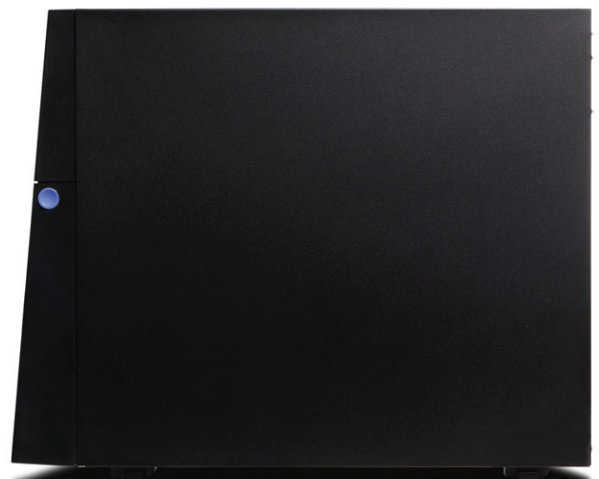

Lenovo ThinkServer TS100

Name	Type-model	Slot x bay	Processor GHz	Cores	Memory	Disk(s)	Disk size	Disk connection	Disk type	RAID controller	SATA optical	Power supply	Limited warranty ¹	Workhorse Global	Avail date
TS100	6432-17U	4x7	E7200	2.53	2 1 x 1GB	None	3.5"	4 x Simple-swap	SATA	1064E	DVD	400W	1-year	No	Sep 08

- **T = Tower, S = Single processor**
- **High performance server with rock solid technology and proven hardware design**
- **Easy to use with ThinkServer EasyStartup, EasyUpdate, and EasyManage software**
- **These small and medium business (SMB) models are part of the US TopSeller™ Program**

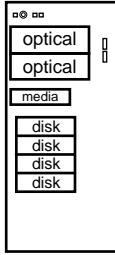
Processor	One Intel® Core™ 2 Duo Processor E7200 with dual-core, one maximum, 1066MHz system bus, and 3MB L2 cache		<p>Tower</p> <ul style="list-style-type: none"> • Business black color; metal case • 8.5"W x 21.25"D x 17.25"H • 216mm W x 540mm D x 438mm H • 56 lb (25.2kg) max configuration • Toolless side cover removal • Toolless disk and optical drive removal • Toolless adapter retention • Illuminated front icons • Rack shelf support 											
Implementation	Processor uses FC-LGA8 package, one LGA775 socket													
Memory	1GB std, 8GB max, PC2-6400 800MHz DDR2, ECC , dual-channel capable, four 184-pin DIMM sockets; <i>Non-italics</i> : standard memory in one socket; three sockets available													
Graphics	ATI® RN50 (ES1000), on planar, 32-bit/33MHz PCI 2.2, 64MB, external monitor port (VGA DB-15); <i>Maximum resolution: 1024x768@85Hz</i>													
Diskette	None (use USB port)													
SATA DVD	DVD-ROM, SATA 1.5Gb/s, uses ICH9R													
SATA disk(s)	None													
SATA controller	Serial ATA, SATA 3.0Gb/s, integrated in ICH9R, not used by disks													
SATA connectors	Six SATA connectors on planar, four simple-swap connectors on 3.5" disk backplate													
SATA RAID cont	LSI™ 1064E, SATA 3.0 Gb/s, RAID® 0, 1 support, Mini PCI Express® adapter													
SAS disk	Not supported													
SAS connectors	Not supported													
SAS controller	Not supported													
Chipset	Intel 3210 Chipset , Intel I/O Controller Hub 9 RAID (ICH9R) for RAID 0, 1, 10 support, SMSC® SCH5027D Super I/O													
Front ports	Two USB 2.0													
Rear ports	Four USB 2.0, two serial (9-pin), parallel, ethernet (RJ-45), monitor (VGA DB-15)													
Diagnostics	Diagnostic LEDs (system-error LED on front cover; error LEDs for fans, disks, memory, processor, PCI slots, power supply)													
Systems mgmt	System management utility, baseboard management controller, IPMI 2.0-compliant													
Audio	None													
Speaker	Internal speaker													
Ethernet	Gigabit ethernet on planar, Broadcom® BCM5722, PCIe x1													
Keyboard	None (use USB port)													
Mouse	None (use USB port)													
Power supply	One 400 watts, one maximum, non-redundant, variable speed fan, non-hot-swap, universal													
Cooling	Three fans (processor, rear, disks)													
Accessories	<table border="0"> <tr> <td>1GB PC2-6400 DDR2 ECC UDIMM</td> <td>45J6188</td> </tr> <tr> <td>2GB PC2-6400 DDR2 ECC UDIMM</td> <td>45J6189</td> </tr> <tr> <td>160GB 3.5" Simple-swap SATA 3.0Gb/s Disk (7200 rpm)</td> <td>45J6195</td> </tr> <tr> <td>250GB 3.5" Simple-swap SATA 3.0Gb/s Disk (7200 rpm)</td> <td>45J6196</td> </tr> <tr> <td>500GB 3.5" Simple-swap SATA 3.0Gb/s Disk (7200 rpm)</td> <td>45J6197</td> </tr> <tr> <td>750GB 3.5" Simple-swap SATA 3.0Gb/s Disk (7200 rpm)</td> <td>45J6198</td> </tr> </table> <p>Other accessories at lenovo.com/accessories</p>		1GB PC2-6400 DDR2 ECC UDIMM	45J6188	2GB PC2-6400 DDR2 ECC UDIMM	45J6189	160GB 3.5" Simple-swap SATA 3.0Gb/s Disk (7200 rpm)	45J6195	250GB 3.5" Simple-swap SATA 3.0Gb/s Disk (7200 rpm)	45J6196	500GB 3.5" Simple-swap SATA 3.0Gb/s Disk (7200 rpm)	45J6197	750GB 3.5" Simple-swap SATA 3.0Gb/s Disk (7200 rpm)	45J6198
1GB PC2-6400 DDR2 ECC UDIMM	45J6188													
2GB PC2-6400 DDR2 ECC UDIMM	45J6189													
160GB 3.5" Simple-swap SATA 3.0Gb/s Disk (7200 rpm)	45J6195													
250GB 3.5" Simple-swap SATA 3.0Gb/s Disk (7200 rpm)	45J6196													
500GB 3.5" Simple-swap SATA 3.0Gb/s Disk (7200 rpm)	45J6197													
750GB 3.5" Simple-swap SATA 3.0Gb/s Disk (7200 rpm)	45J6198													
	<p>Security</p> <ul style="list-style-type: none"> • Side cover lock (ships with two identical keys) <ul style="list-style-type: none"> - prohibits removal of front panel and disks • Power-on password • Administrator password • Boot sequence control • Boot without keyboard, mouse, diskette • Serial port I/O control • USB port disablement (all) 													
	<p>Software management tools</p> <ul style="list-style-type: none"> • ThinkServer EasyStartup • ThinkServer EasyUpdate • ThinkServer EasyManage 													
	ThinkPlus Priority Support, 90-day Trial													
	RoHS-compliant													
	<p>Limited Warranty¹</p> <ul style="list-style-type: none"> ⇒ 1-year parts and labor ⇒ Customer Replaceable Unit (CRU) parts only (with limited onsite service for selected parts³, 8 am - 5 pm, Mon - Fri coverage excluding holidays, next business day response time) ⇒ ThinkPlus™ services available; see lenovo.com/thinkplus/warranty <ul style="list-style-type: none"> • Onsite service upgrade options (in eligible locations)⁷ • Post warranty maintenance services ⇒ 24 hour x 7 day¹⁴ toll-free support during the warranty period¹ via 800-426-7378 													

See footnotes for important warranty information
US models announced September 30, 2008

Name	Type-model	Slot x bay	Processor	GHz	Cores	Memory	Disk(s)	Disk size	Disk connection	Disk type	RAID controller	SATA optical	Power supply(s)	Limited Warranty ¹	Workhorse Global	Avail date
TS100	6434-13U	4x7	E3110	3.00	2	2 x 1GB	None	3.5"	4 x Simple-swap	SATA	1064E	DVD	400W	3-year	No	Sep 08
TS100	6434-15U	4x7	X3360	2.83	4	2 x 2GB	None	3.5"	4 x Hot-swap	SATA/SAS ⁴	MR10i	DVD	2 x 430W	3-year	No	Sep 08

- **T = Tower, S = Single processor**
- **High performance server with rock solid technology and proven hardware design**
- **Easy to use with ThinkServer EasyStartup, EasyUpdate, and EasyManage software**
- **These small and medium business (SMB) models are part of the US TopSeller™ Program**

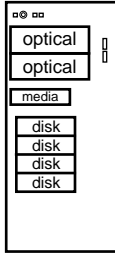
Processor	One Intel® Xeon® Processor E3110 with dual-core, one maximum, 1333MHz system bus, and 6MB L2 cache or One Intel Xeon Processor X3360 with quad-core, one maximum, 1333MHz system bus, and 12MB L2 cache Processor uses FC-LGA8 package, one LGA775 socket		Tower		
Implementation	One Intel Xeon Processor X3360 with quad-core, one maximum, 1333MHz system bus, and 12MB L2 cache Processor uses FC-LGA8 package, one LGA775 socket		<ul style="list-style-type: none"> • Business black color; metal case • 8.5"W x 21.25"D x 17.25"H • 216mm W x 540mm D x 438mm H • 56 lb (25.2kg) max configuration • Toolless side cover removal • Toolless disk and optical drive removal • Toolless adapter retention • Illuminated front icons • Rack shelf support 		
Memory	2GB or 4GB std, 8GB max, PC2-6400 800MHz DDR2, ECC , dual-channel capable, four 240-pin DIMM sockets; <i>Non-italics:</i> standard memory in two sockets; two sockets available		<ul style="list-style-type: none"> Bay ① 5.25", 1.6" high, external, standard optical Bay ② 5.25", 1.6" high, external, optional optical Bay ③ 3.5", 1" high, external, open Bay ④ 3.5", 1" high, internal, optional disk Bay ⑤ 3.5", 1" high, internal, optional disk Bay ⑥ 3.5", 1" high, internal, optional disk Bay ⑦ 3.5", 1" high, internal, optional disk 		
Graphics	ATI® RN50 (ES1000), on planar, 32-bit/33MHz PCI 2.2, 64MB, external monitor port (VGA DB-15); <i>Maximum resolution:</i> 1024x768@85Hz		<ul style="list-style-type: none"> Slot 1: full-length, full-height, PCIe x8 Slot 2: full-length, full-height, PCIe x1 (x4 mechanical) Slot 3: full-length, full-height, 64-bit PCI-X (not enabled) Slot 4: full-length, full-height, 32-bit PCI 2.2 Slot 5: half-length, full-height, 32-bit PCI 2.2 		
Diskette	None (use USB port)				
SATA DVD	DVD-ROM, SATA 1.5Gb/s, uses ICH9R				
SATA disk(s)	None				
SATA controller	Serial ATA, SATA 3.0Gb/s, integrated in ICH9R, not used by disks				
SATA connectors	Six SATA connectors on planar, 13U SATA: 4 simple-swap connectors on 3.5" disk backplane 15U SATA/SAS: 4 hot-swap connectors on 3.5" disk backplane				
SATA RAID cont	LSI™ 1064E, SATA 3.0 Gb/s, RAID ⁸ 0, 1 support, Mini PCI Express [®] adapter				
SAS disk(s)	None				
SAS connectors	15U SATA/SAS: 4 hot-swap connectors on 3.5" disk backplane				
SAS RAID cont	15U: LSI MR10i, SATA 3.0 Gb/s, SAS 3.0 Gb/s, RAID ⁸ 0, 1, 5, 6, 10, 50, 60 support, Mini PCI Express adapter				
Chipset	Intel 3210 Chipset , Intel I/O Controller Hub 9 RAID (ICH9R) for RAID 0, 1, 10 support, SMSC [®] SCH5027D Super I/O		<p style="text-align: center;">Security</p> <ul style="list-style-type: none"> • Side cover lock (ships with two identical keys) - prohibits removal of front panel and disks • Power-on password • Administrator password • Boot sequence control • Boot without keyboard, mouse, diskette • Serial port I/O control • USB port disablement (all) 		
Front ports	Two USB 2.0				
Rear ports	Four USB 2.0, two serial (9-pin), parallel, ethernet (RJ-45), monitor (VGA DB-15)				
Diagnostics	Diagnostic LEDs (system-error LED on front cover; error LEDs for fans, disks, memory, processor, PCI slots, power supply)				
Systems mgmt	System management utility, baseboard management controller, IPMI 2.0-compliant		<p style="text-align: center;">Software management tools</p> <ul style="list-style-type: none"> • ThinkServer EasyStartup • ThinkServer EasyUpdate • ThinkServer EasyManage 		
Audio	None				
Speaker	Internal speaker				
Ethernet	Gigabit ethernet on planar, Broadcom [®] BCM5722, PCIe x1				
Keyboard	None (use USB port)				
Mouse	None (use USB port)				
Power supply	<i>Some:</i> One 400 watts, one maximum, non-redundant, variable speed fan, non-hot-swap, universal <i>Some:</i> Two 430 watts, two maximum, redundant with two, variable speed fan, hot-swap, universal		ThinkPlus Priority Support, 90-day Trial		
Cooling	Three fans (processor, rear, disks)		RoHS-compliant		
Accessories	1GB PC2-6400 DDR2 ECC UDIMM 45J6188 2GB PC2-6400 DDR2 ECC UDIMM 45J6189 160GB 3.5" Simple-swap SATA 3.0Gb/s Disk (7200 rpm) 45J6195 250GB 3.5" Simple-swap SATA 3.0Gb/s Disk (7200 rpm) 45J6196 500GB 3.5" Simple-swap SATA 3.0Gb/s Disk (7200 rpm) 45J6197 750GB 3.5" Simple-swap SATA 3.0Gb/s Disk (7200 rpm) 45J6198 160GB 3.5" Hot-swap SATA 3.0Gb/s Disk (7200 rpm) 45J6200 250GB 3.5" Hot-swap SATA 3.0Gb/s Disk (7200 rpm) 45J6201 500GB 3.5" Hot-swap SATA 3.0Gb/s Disk (7200 rpm) 45J6202 750GB 3.5" Hot-swap SATA 3.0Gb/s Disk (7200 rpm) 45J6203 1TB 3.5" Hot-swap SATA 3.0Gb/s Disk (7200 rpm) 45J6204 146GB 3.5" Hot-swap SAS 3.0Gb/s Disk (15000 rpm) 45J6211 300GB 3.5" Hot-swap SAS 3.0Gb/s Disk (15000 rpm) 45J6212 Other accessories at lenovo.com/accessories		<p style="text-align: center;">Limited Warranty¹</p> <ul style="list-style-type: none"> ⇒ 3-year parts and labor ⇒ Customer Replaceable Unit (CRU) parts only (with limited onsite service for selected parts³, 8 am - 5 pm, Mon - Fri coverage excluding holidays, next business day response time) ⇒ ThinkPlus™ services available; see lenovo.com/thinkplus/warranty <ul style="list-style-type: none"> • Onsite service upgrade options (in eligible locations)⁷ • Post warranty maintenance services ⇒ 24 hour x 7 day¹⁴ toll-free support during the warranty period¹ via 800-426-7378 		

See footnotes for important warranty information
US models announced September 30, 2008



Lenovo ThinkServer TD100



Lenovo ThinkServer TD100x

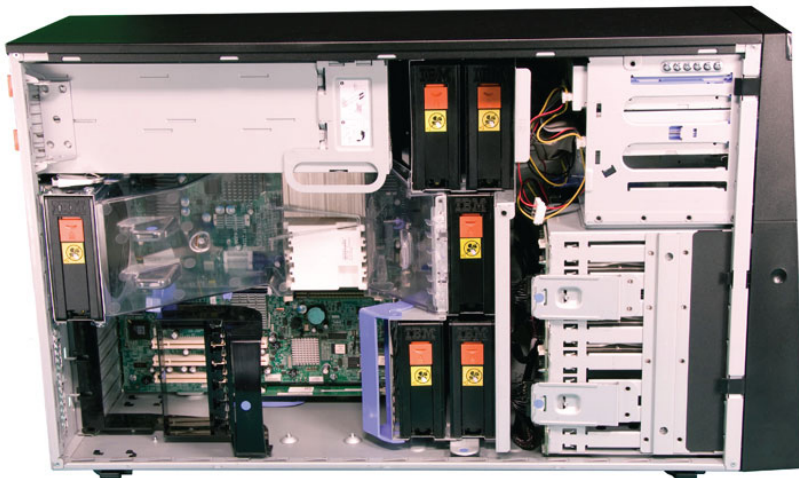

Lenovo ThinkServer TD100
or TD100x



Lenovo ThinkServer TD100
or TD100x



Lenovo ThinkServer TD100x
with Easy LED Diagnostic panel

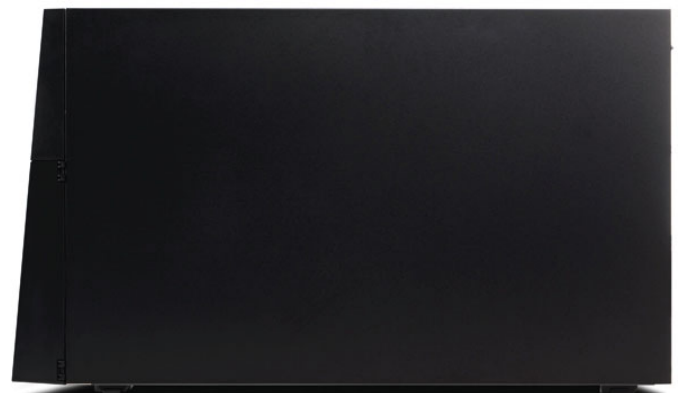

Lenovo ThinkServer TD100
or TD100x

Name	Type-model	Slot x bay	Processor(s)	GHz	Cores	Memory	Disk(s) size	Disk connection	Disk type	RAID controller	EIDE optical	Power supply(s)	Fans	Limited warranty ¹	Workhorse Global	Avail date
TD100	6399-14U	6x7	1 x E5405	2.00	4	2 x 1GB	None 3.5"	4 x Simple-swap	SATA	RAID-8k	DVD	670W	3	1-year	No	Sep 08

- **T = Tower, D = Dual processor support**
- **High performance server with rock solid technology and proven hardware design**
- **Easy to use with ThinkServer EasyStartup, EasyUpdate, and EasyManage software**
- **These small and medium business (SMB) models are part of the US TopSeller™ Program**

Processor(s)	One Intel® Xeon® Processor E5405 with quad-core , two maximum, 1333MHz system bus, and 12MB L2 cache	Tower																	
Implementation	Processor uses FC-LGA6 package, two LGA771 sockets																		
Memory	2GB std, 32GB max, PC2-5300 667MHz DDR2, Advanced ECC , fully buffered, eight 240-pin DIMM sockets; <i>Non-italics:</i> standard memory in two sockets; six sockets available	<ul style="list-style-type: none"> • Business black color; metal case • 8.6"W x 29.4"D x 17.3"H • 218mm W x 747mm D x 440mm H • 75 lb (34kg) max configuration • Toolless side cover removal • Toolless disk and optical drive removal • Toolless adapter retention • Illuminated front icons • Rack shelf support 																	
Graphics	ATI® RN50 (ES1000), on planar; 32-bit/33MHz PCI 2.3, 16MB, external monitor port (VGA DB-15 rear); <i>Maximum resolution:</i> 800x600@85Hz	<p>Bay ① 5.25", 1.6" high, external, std optical</p> <p>Bay ② 5.25", 1.6" high, external, optional tape or optical</p> <p>Bay ③ 5.25", 1.6" high, external, optional tape or optical</p> <p>Bay ④ 3.5", 1" high, external, optional disk</p> <p>Bay ⑤ 3.5", 1" high, external, optional disk</p> <p>Bay ⑥ 3.5", 1" high, external, optional disk</p> <p>Bay ⑦ 3.5", 1" high, external, optional disk</p>																	
EIDE controller	Enhanced IDE/ATA 100 controller in Enterprise South Bridge, one connector on planar, single 2-drop IDE cable (for DVD)	<p>Slot 1: half-length, full-height, PCIe® x4 (x8 mechanical)</p> <p>Slot 2: full-length, full-height, PCIe x8</p> <p>Slot 3: full-length, full-height, PCIe x8</p> <p>Slot 4: full-length, full-height, 64-bit PCI-X</p> <p>Slot 5: full-length, full-height, 64-bit PCI-X</p> <p>Slot 6: half-length, full-height, PCI</p>																	
EIDE DVD	DVD-ROM, 1.6" high	Security																	
SATA disk(s)	None	<ul style="list-style-type: none"> • Side cover lock (ships with two identical keys) <ul style="list-style-type: none"> - prohibits removal of front panel and disks • Power-on password • Administrator password • Boot sequence control • Boot without keyboard, mouse, diskette • Serial port I/O control • USB port disablement (all) 																	
SATA connectors	Four simple-swap connectors on 3.5" disk backplane	<p>ThinkPlus Priority Support, 90-day Trial</p>																	
SAS disk(s)	None	<p>RoHS-compliant</p>																	
SATA/SAS cont	Adaptec® AIC-9580W, SATA 3.0Gb/s, SAS 3.0Gb/s, RAID® 0, 1, 10 support, 8-port, on planar, not used	<p>Limited Warranty¹</p> <ul style="list-style-type: none"> ⇒ 1-year parts and labor ⇒ Customer Replaceable Unit (CRU) parts only (with limited onsite service for selected parts³, 8 am - 5 pm, Mon - Fri coverage excluding holidays, next business day response time) ⇒ ThinkPlus™ services available; see lenovo.com/thinkplus/warranty <ul style="list-style-type: none"> • Onsite service upgrade options (in eligible locations)⁷ • Post warranty maintenance services ⇒ 24 hour x 7 day¹⁴ toll-free support during the warranty period¹ via 800-426-7378 																	
SAS connectors	None	<p>Software management tools</p> <ul style="list-style-type: none"> • ThinkServer EasyStartup • ThinkServer EasyUpdate • ThinkServer EasyManage 																	
SATA/SAS RAID controller	RAID-8k Adapter, SATA 3.0Gb/s, SAS 3.0Gb/s, RAID® 0, 1, 1e, 5, 6, 10 support, in reserved connector, single cable to backplane	<p>Accessories</p> <table border="0"> <tr> <td>Intel Xeon Quad-Core Processor E5405</td> <td>45J6221</td> </tr> <tr> <td>1GB PC2-5300 DDR2 ECC FB-DIMM</td> <td>45J6191</td> </tr> <tr> <td>2GB PC2-5300 DDR2 ECC FB-DIMM</td> <td>45J6192</td> </tr> <tr> <td>4GB PC2-5300 DDR2 ECC FB-DIMM</td> <td>45J6193</td> </tr> <tr> <td>160GB 3.5" Simple-swap SATA 3.0Gb/s Disk (7200 rpm)</td> <td>45J6195</td> </tr> <tr> <td>250GB 3.5" Simple-swap SATA 3.0Gb/s Disk (7200 rpm)</td> <td>45J6196</td> </tr> <tr> <td>500GB 3.5" Simple-swap SATA 3.0Gb/s Disk (7200 rpm)</td> <td>45J6197</td> </tr> <tr> <td>750GB 3.5" Simple-swap SATA 3.0Gb/s Disk (7200 rpm)</td> <td>45J6198</td> </tr> </table> <p>Other accessories at lenovo.com/accessories</p>		Intel Xeon Quad-Core Processor E5405	45J6221	1GB PC2-5300 DDR2 ECC FB-DIMM	45J6191	2GB PC2-5300 DDR2 ECC FB-DIMM	45J6192	4GB PC2-5300 DDR2 ECC FB-DIMM	45J6193	160GB 3.5" Simple-swap SATA 3.0Gb/s Disk (7200 rpm)	45J6195	250GB 3.5" Simple-swap SATA 3.0Gb/s Disk (7200 rpm)	45J6196	500GB 3.5" Simple-swap SATA 3.0Gb/s Disk (7200 rpm)	45J6197	750GB 3.5" Simple-swap SATA 3.0Gb/s Disk (7200 rpm)	45J6198
Intel Xeon Quad-Core Processor E5405	45J6221																		
1GB PC2-5300 DDR2 ECC FB-DIMM	45J6191																		
2GB PC2-5300 DDR2 ECC FB-DIMM	45J6192																		
4GB PC2-5300 DDR2 ECC FB-DIMM	45J6193																		
160GB 3.5" Simple-swap SATA 3.0Gb/s Disk (7200 rpm)	45J6195																		
250GB 3.5" Simple-swap SATA 3.0Gb/s Disk (7200 rpm)	45J6196																		
500GB 3.5" Simple-swap SATA 3.0Gb/s Disk (7200 rpm)	45J6197																		
750GB 3.5" Simple-swap SATA 3.0Gb/s Disk (7200 rpm)	45J6198																		
Chipset	Intel 5000P chipset , Intel 6321ESB-2E I/O Controller Hub, NS PC8374L Super I/O	<p>See footnotes for important warranty information</p>																	
Front ports	Two USB 2.0	<p>© Lenovo</p>																	
Rear ports	Two USB 2.0, two serial (9-pin), parallel, keyboard (PS/2), mouse (PS/2), external monitor (VGA DB-15), ethernet (RJ-45), system management (RJ-45)	<p>(TD100-1) October 2008</p>																	
Diagnostics	Diagnostic LEDs (system-error LED on front cover; error LEDs for RAID, memory, processors, PCI slots, voltage regulator module, power supply)																		
Systems mgmt	System management utility, baseboard management controller, IPMI 2.0-compliant																		
Audio	None																		
Speaker	Internal speaker																		
Ethernet	Gigabit ethernet on planar, Broadcom® BCM5721, PCIe x1, full duplex, Wake on LAN®																		
Keyboard	None (use PS/2 or USB port)																		
Mouse	None (use PS/2 or USB port)																		
Power supply	One 670 watts, one maximum, non-redundant, variable speed fan, non-hot-swap, universal																		
Cooling	Three or six fans, six maximum, variable speed, hardware failure protection, hot-swap, six fans required with second redundant power supply																		

See footnotes for important warranty information
US models announced September 30, 2008

© Lenovo
(TD100-1) October 2008

Name	Type-model	Slot x bay	Processor(s)	GHz	Cores	Memory	Disk(s)	Disk size	Disk connection	Disk type	RAID controller	EIDE optical	Power supply(s)	Fans	Limited warranty ¹	Workhorse Global	Avail date
TD100	6429-17U	6x11 1	x E5410	2.33	4	2 x 1GB	None	3.5"	8 x Hot-swap	SATA/SAS ⁴	RAID-8k DVD	2 x 835W	6	3-year	No	Sep 08	
TD100	6429-18U	6x11 1	x E5430	2.66	4	2 x 2GB	None	3.5"	8 x Hot-swap	SATA/SAS ⁴	RAID-8k DVD	2 x 835W	6	3-year	No	Sep 08	

- **T = Tower, D = Dual processor support**
- **High performance server with rock solid technology and proven hardware design**
- **Easy to use with ThinkServer EasyStartup, EasyUpdate, and EasyManage software**
- **These small and medium business (SMB) models are part of the US TopSeller™ Program**

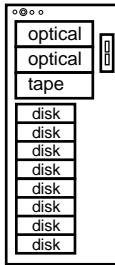
Processor(s)	One Intel® Xeon® Processor E5410 or E5430 with quad-core, two maximum, 1333MHz system bus, and 12MB L2 cache	Tower <ul style="list-style-type: none"> • Business black color; metal case • 8.6"W x 29.4"D x 17.3"H • 218mm W x 747mm D x 440mm H • 75 lb (34kg) max configuration • Toolless side cover removal • Toolless disk and optical drive removal • Toolless adapter retention • Illuminated front icons • Rack shelf support 
Implementation	Processor uses FC-LGA6 package, two LGA771 sockets	
Memory	2GB or 4GB std, 32GB max, PC2-5300 667MHz DDR2, Advanced ECC , fully buffered, eight 240-pin DIMM sockets; <i>Non-italics</i> : standard memory in two sockets; six sockets available	
Graphics	ATI® RN50 (ES1000), on planar, 32-bit/33MHz PCI 2.3, 16MB, external monitor port (VGA DB-15 rear); <i>Maximum resolution</i> : 800x600@85Hz	
EIDE controller	Enhanced IDE/ATA 100 controller in Enterprise South Bridge, one connector on planar, single 2-drop IDE cable (for DVD)	
EIDE DVD	DVD-ROM, 1.6" high	
SATA disk(s)	None	
SATA connectors	Eight hot-swap connectors on 3.5" disk backplane	
SAS disk(s)	None	
SATA/SAS cont	Adaptec® AIC-9580W, SATA 3.0Gb/s, SAS 3.0Gb/s, RAID® 0, 1, 10 support, 8-port, on planar, not used	
SAS connectors	Eight hot-swap connectors on 3.5" disk backplane	
SATA/SAS RAID controller	RAID-8k Adapter, SATA 3.0Gb/s, SAS 3.0Gb/s, RAID® 0, 1, 1e, 5, 6, 10 support, in reserved connector, single cable to backplane	
Chipset	Intel 5000P chipset , Intel 6321ESB-2E I/O Controller Hub, NS PC8374L Super I/O	
Front ports	Two USB 2.0	
Rear ports	Two USB 2.0, two serial (9-pin), parallel, keyboard (PS/2), mouse (PS/2), external monitor (VGA DB-15), ethernet (RJ-45), system management (RJ-45)	
Diagnostics	Diagnostic LEDs (system-error LED on front cover; error LEDs for RAID, memory, processors, PCI slots, voltage regulator module, power supply)	
Systems mgmt	System management utility, baseboard management controller, IPMI 2.0-compliant	
Audio	None	
Speaker	Internal speaker	
Ethernet	Gigabit ethernet on planar, Broadcom® BCM5721, PCIe x1, full duplex, Wake on LAN®	
Keyboard	None (use PS/2 or USB port)	
Mouse	None (use PS/2 or USB port)	
Power supply	Two 835 watts, two maximum, redundant with two, variable speed fan, hot-swap, universal, two redundant power supplies require six fans	
Cooling	Six fans, six maximum, variable speed, hardware failure protection, hot-swap, six fans required with second redundant power supply	
Software management tools		
• ThinkServer EasyStartup • ThinkServer EasyUpdate • ThinkServer EasyManage		ThinkPlus Priority Support, 90-day Trial
Accessories		RoHS-compliant
Intel Xeon Quad-Core Processor E5410	45J6185	Limited Warranty¹ <ul style="list-style-type: none"> ↪ 3-year parts and labor ↪ Customer Replaceable Unit (CRU) parts only (with limited onsite service for selected parts³, 8 am - 5 pm, Mon - Fri coverage excluding holidays, next business day response time) ↪ ThinkPlus™ services available; see lenovo.com/thinkplus/warranty <ul style="list-style-type: none"> • Onsite service upgrade options (in eligible locations)⁷ • Post warranty maintenance services ↪ 24 hour x 7 day¹⁴ toll-free support during the warranty period¹ via 800-426-7378
Intel Xeon Quad-Core Processor E5430	45J6186	
1GB PC2-5300 DDR2 ECC FB-DIMM	45J6191	
2GB PC2-5300 DDR2 ECC FB-DIMM	45J6192	
4GB PC2-5300 DDR2 ECC FB-DIMM	45J6193	
160GB 3.5" Hot-swap SATA 3.0Gb/s Disk (7200 rpm)	45J6200	
250GB 3.5" Hot-swap SATA 3.0Gb/s Disk (7200 rpm)	45J6201	
500GB 3.5" Hot-swap SATA 3.0Gb/s Disk (7200 rpm)	45J6202	
750GB 3.5" Hot-swap SATA 3.0Gb/s Disk (7200 rpm)	45J6203	
1TB 3.5" Hot-swap SATA 3.0Gb/s Disk (7200 rpm)	45J6204	
146GB 3.5" Hot-swap SAS 3.0Gb/s Disk (15000 rpm)	45J6211	
300GB 3.5" Hot-swap SAS 3.0Gb/s Disk (15000 rpm)	45J6212	
Other accessories at lenovo.com/accessories		

See footnotes for important warranty information
US models announced September 30, 2008

Name	Type-model	Slot x bay	Processor(s)	GHz	Cores	Memory	Disk(s)	Disk size	Disk connection	Disk type	RAID controller	EIDE optical	Power supply(s)	Fans	Limited warranty ¹	Workhorse Global	Avail date
TD100x	4206-14U	6x11	1 x X5450	3.00	4	2 x 2GB	None	3.5"	8 x Hot-swap	SATA/SAS ⁴	RAID-8k	DVD	2 x 835W	6	3-year	No	Sep 08

- **T = Tower, D = Dual processor support**
- **These small and medium business (SMB) models are part of the US TopSeller™ Program**
- **The TD100x differs from the TD100 because of the following standard features:**
Easy LED Diagnostic panel, support for up to eight 3.5" hot-swap SAS disks, two redundant 835 watt power supplies, six redundant fans

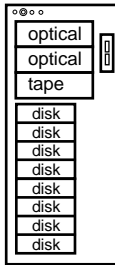
Processor(s)	One Intel® Xeon® Processor X5450 with quad-core, two maximum, 1333MHz system bus, and 12MB L2 cache	Tower <ul style="list-style-type: none"> • Business black color; metal case • 8.6"W x 29.4"D x 17.3"H • 218mm W x 747mm D x 440mm H • 75 lb (34kg) max configuration • Toolless side cover removal • Toolless disk and optical drive removal • Toolless adapter retention • Illuminated front icons • Rack shelf support 																						
Implementation	Processor uses FC-LGA6 package, two LGA771 sockets																							
Memory	4GB std, 48GB max, PC2-5300 667MHz DDR2, Advanced ECC , fully buffered, twelve 240-pin DIMM sockets; <i>Non-italics:</i> standard memory in two sockets; ten sockets available																							
Graphics	ATI® RN50 (ES1000), on planar, 32-bit/33MHz PCI 2.3, 16MB, external monitor port (VGA DB-15 rear); <i>Maximum resolution:</i> 800x600@85Hz																							
EIDE controller	Enhanced IDE/ATA 100 controller in Enterprise South Bridge, one connector on planar, single 2-drop IDE cable (DVD)																							
EIDE DVD	DVD-ROM, 1.6" high																							
SATA disk(s)	None																							
SATA connectors	Eight hot-swap connectors on 3.5" disk backplane																							
SAS disk(s)	None																							
SATA/SAS cont	Adaptec® AIC-9580W, SATA 3.0Gb/s, SAS 3.0Gb/s, RAID® 0, 1, 10 support, 8-port, on planar, not used																							
SAS connectors	Eight hot-swap connectors on 3.5" disk backplane																							
SATA/SAS RAID controller	RAID-8k Adapter, SATA 3.0Gb/s, SAS 3.0Gb/s, RAID® 0, 1, 1e, 5, 6, 10 support, in reserved connector, single cable to backplane																							
Chipset	Intel 5000P chipset , Intel 6321ESB-2E I/O Controller Hub, NS PC8374L Super I/O	Bay ① 5.25", 1.6" high, external, std optical Bay ② 5.25", 1.6" high, external, optional tape or optical Bay ③ 5.25", 1.6" high, external, optional tape or optical Bay ④ 3.5", 1" high, external, optional disk Bay ⑤ 3.5", 1" high, external, optional disk Bay ⑥ 3.5", 1" high, external, optional disk Bay ⑦ 3.5", 1" high, external, optional disk Bay ⑧ 3.5", 1" high, external, optional disk Bay ⑨ 3.5", 1" high, external, optional disk Bay ⑩ 3.5", 1" high, external, optional disk																						
Front ports	Two USB 2.0	Slot 1: half-length, full-height, PCIe® x4 (x8 mechanical)																						
Rear ports	Two USB 2.0, two serial (9-pin), parallel, keyboard (PS/2), mouse (PS/2), external monitor (VGA DB-15), ethernet (RJ-45), system management (RJ-45)	Slot 2: full-length, full-height, PCIe x8																						
Diagnostics	Easy LED Diagnostics (operator information panel on left side with error LEDs for fans, disks, RAID, memory, processors, voltage regulator module, PCI slots, power supplies)	Slot 3: full-length, full-height, PCIe x8																						
Systems mgmt	System management utility, baseboard management controller, IPMI 2.0-compliant	Slot 4: full-length, full-height, 64-bit PCI-X																						
Audio	None	Slot 5: full-length, full-height, 64-bit PCI-X																						
Speaker	Internal speaker	Slot 6: half-length, full-height, PCI																						
Ethernet	Gigabit ethernet on planar, Broadcom® BCM5721, PCIe x1, full duplex, Wake on LAN®	Security <ul style="list-style-type: none"> • Side cover lock (ships with two identical keys) - prohibits removal of front panel and disks • Power-on password • Administrator password • Boot sequence control • Boot without keyboard, mouse, diskette • Serial port I/O control • USB port disablement (all) 																						
Keyboard	None (use PS/2 or USB port)	ThinkPlus Priority Support, 90-day Trial																						
Mouse	None (use PS/2 or USB port)	RoHS-compliant																						
Power supply	Two 835 watts, two maximum, redundant with 2, variable speed fan, hot-swap, universal, two redundant power supplies require six fans	Limited Warranty¹ <ul style="list-style-type: none"> ⇒ 3-year parts and labor ⇒ Customer Replaceable Unit (CRU) parts only (with limited onsite service for selected parts³, 8 am - 5 pm, Mon - Fri coverage excluding holidays, next business day response time) ⇒ ThinkPlus™ services available; see lenovo.com/thinkplus/warranty <ul style="list-style-type: none"> • Onsite service upgrade options (in eligible locations)⁷ • Post warranty maintenance services ⇒ 24 hour x 7 day¹⁴ toll-free support during the warranty period¹ via 800-426-7378 																						
Cooling	Six fans, six maximum, variable speed, hardware failure protection, hot-swap, six fans required with second redundant power supply																							
Software management tools																								
• ThinkServer EasyStartup • ThinkServer EasyUpdate • ThinkServer EasyManage																								
Accessories <table border="0"> <tr><td>Intel® Xeon® Quad-Core Processor X5450</td><td>45K1608</td></tr> <tr><td>1GB PC2-5300 DDR2 ECC FB-DIMM</td><td>45J6191</td></tr> <tr><td>2GB PC2-5300 DDR2 ECC FB-DIMM</td><td>45J6192</td></tr> <tr><td>4GB PC2-5300 DDR2 ECC FB-DIMM</td><td>45J6193</td></tr> <tr><td>160GB 3.5" Hot-swap SATA 3.0Gb/s Disk (7200 rpm)</td><td>45J6200</td></tr> <tr><td>250GB 3.5" Hot-swap SATA 3.0Gb/s Disk (7200 rpm)</td><td>45J6201</td></tr> <tr><td>500GB 3.5" Hot-swap SATA 3.0Gb/s Disk (7200 rpm)</td><td>45J6202</td></tr> <tr><td>750GB 3.5" Hot-swap SATA 3.0Gb/s Disk (7200 rpm)</td><td>45J6203</td></tr> <tr><td>1TB 3.5" Hot-swap SATA 3.0Gb/s Disk (7200 rpm)</td><td>45J6204</td></tr> <tr><td>146GB 3.5" Hot-swap SAS 3.0Gb/s Disk (15000 rpm)</td><td>45J6211</td></tr> <tr><td>300GB 3.5" Hot-swap SAS 3.0Gb/s Disk (15000 rpm)</td><td>45J6212</td></tr> </table> Other accessories at lenovo.com/accessories		Intel® Xeon® Quad-Core Processor X5450	45K1608	1GB PC2-5300 DDR2 ECC FB-DIMM	45J6191	2GB PC2-5300 DDR2 ECC FB-DIMM	45J6192	4GB PC2-5300 DDR2 ECC FB-DIMM	45J6193	160GB 3.5" Hot-swap SATA 3.0Gb/s Disk (7200 rpm)	45J6200	250GB 3.5" Hot-swap SATA 3.0Gb/s Disk (7200 rpm)	45J6201	500GB 3.5" Hot-swap SATA 3.0Gb/s Disk (7200 rpm)	45J6202	750GB 3.5" Hot-swap SATA 3.0Gb/s Disk (7200 rpm)	45J6203	1TB 3.5" Hot-swap SATA 3.0Gb/s Disk (7200 rpm)	45J6204	146GB 3.5" Hot-swap SAS 3.0Gb/s Disk (15000 rpm)	45J6211	300GB 3.5" Hot-swap SAS 3.0Gb/s Disk (15000 rpm)	45J6212	
Intel® Xeon® Quad-Core Processor X5450	45K1608																							
1GB PC2-5300 DDR2 ECC FB-DIMM	45J6191																							
2GB PC2-5300 DDR2 ECC FB-DIMM	45J6192																							
4GB PC2-5300 DDR2 ECC FB-DIMM	45J6193																							
160GB 3.5" Hot-swap SATA 3.0Gb/s Disk (7200 rpm)	45J6200																							
250GB 3.5" Hot-swap SATA 3.0Gb/s Disk (7200 rpm)	45J6201																							
500GB 3.5" Hot-swap SATA 3.0Gb/s Disk (7200 rpm)	45J6202																							
750GB 3.5" Hot-swap SATA 3.0Gb/s Disk (7200 rpm)	45J6203																							
1TB 3.5" Hot-swap SATA 3.0Gb/s Disk (7200 rpm)	45J6204																							
146GB 3.5" Hot-swap SAS 3.0Gb/s Disk (15000 rpm)	45J6211																							
300GB 3.5" Hot-swap SAS 3.0Gb/s Disk (15000 rpm)	45J6212																							

See footnotes for important warranty information
 US models announced September 30, 2008

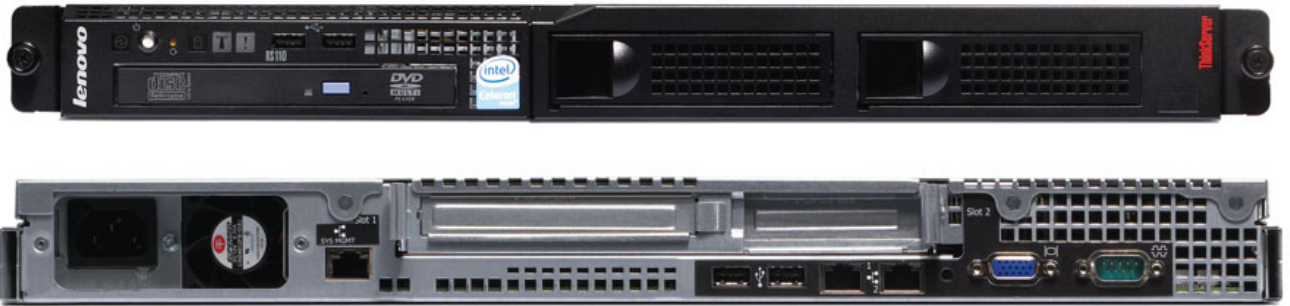

Lenovo ThinkServer RS110

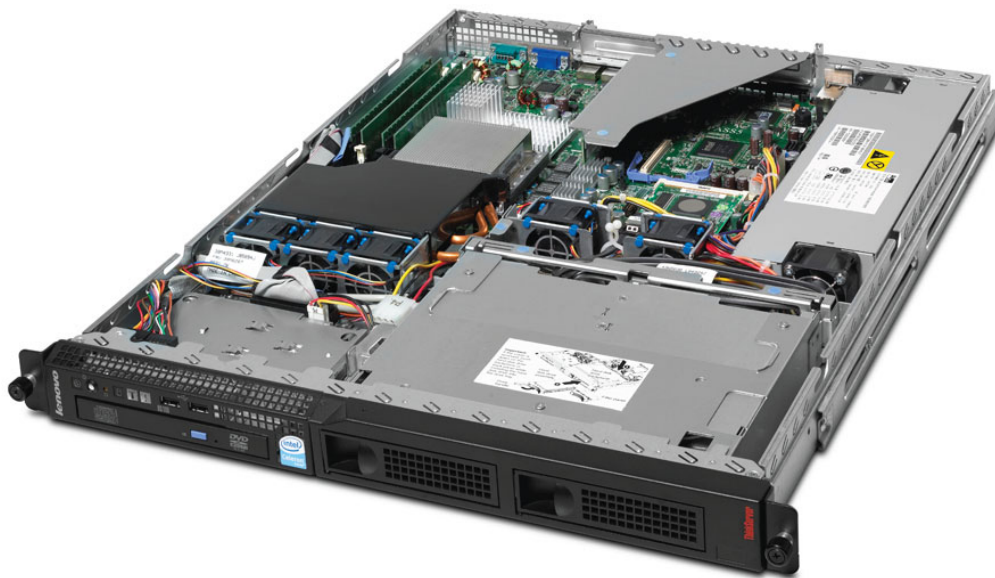

Lenovo ThinkServer RS110

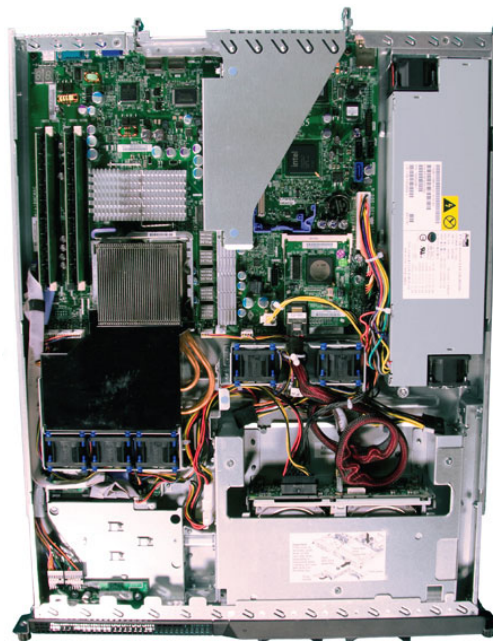

Lenovo ThinkServer RS110

Name	Type-model	Slot x bay	Processor	GHz	Cores	Memory	Disk(s) size	Disk connection	Disk type	RAID controller	EIDE optical	Power supply	Fans	Limited warranty ¹	Workhorse Global	Avail date	
RS110	6436-15U	2x3	E7200	2.53	2	1 x 1GB	None	3.5" 2 x	Simple-swap	SATA	1064E	Combo	350W	5	1-year	No	Sep 08

- **R = Rack, S = Single processor**
- **High performance server with rock solid technology and proven hardware design**
- **Easy to use with ThinkServer EasyStartup, EasyUpdate, and EasyManage software**
- **These small and medium business (SMB) models are part of the US TopSeller™ Program**

Processor	One Intel® Core™ 2 Duo Processor E7200 with dual-core, one maximum, 1066MHz system bus, and 3MB L2 cache	<p>1U Rack top</p> <p>Front</p> <p>optical disk disk</p> <p>Rear</p> <p>PSU [1 - PCIe x8] [2 - PCIe x4]</p> <ul style="list-style-type: none"> • Black color front; metal case • 17.3" W x 22" D x 1.75" H • 440mm W x 559mm D x 43mm H • 28 lb (12.7kg) max configuration • Toolless top cover removal • Toolless disk and optical drive removal • Toolless adapter retention • Illuminated front icons with system error LED <p>Bay ① 5.25", 0.5" high, external, std optical</p> <p>Bay ② 3.5", 1" high, external, optional disk</p> <p>Bay ③ 3.5", 1" high, external, optional disk</p> <p>PCI Express riser card:</p> <p>Slot 1: 3/4-length, full-height, PCIe x8</p> <p>Slot 2: half-length, low-profile, PCIe x4 (x8 mechanical)</p> <p>Security</p> <ul style="list-style-type: none"> • Power-on password • Administrator password • Boot sequence control • Boot without keyboard, mouse, diskette • Serial port I/O control • USB port disablement (front or all) <p>ThinkPlus Priority Support, 90-day Trial</p> <p>RoHS-compliant</p> <p>Limited Warranty¹</p> <ul style="list-style-type: none"> ↔ 1-year parts and labor ↔ Customer Replaceable Unit (CRU) parts only (with limited onsite service for selected parts³, 8 am - 5 pm, Mon - Fri coverage excluding holidays, next business day response time) ↔ ThinkPlus™ services available; see lenovo.com/thinkplus/warranty • Onsite service upgrade options (in eligible locations)⁷ • Post warranty maintenance services ↔ 24 hour x 7 day¹⁴ toll-free support during the warranty period¹ via 800-426-7378
Implementation	Processor uses FC-LGA8 package, one LGA775 socket	
Memory	1GB std, 8GB max, PC2-6400 800MHz DDR2, ECC , dual-channel capable, four 240-pin DIMM sockets; <i>Non-italics</i> : standard memory in one socket; three sockets available	
Graphics	ATI® RN50 (ES1000), on planar, 32-bit/33MHz PCI 2.3, 16MB, external monitor port (VGA DB-15 rear); <i>Maximum resolution</i> : 800x600@85Hz	
EIDE controller	Enhanced IDE controller in Enterprise South Bridge, one connector on planar, single 1-drop IDE cable (for Combo)	
EIDE Combo	DVD-ROM/CD-RW, Ultrabay Enhanced, 12.7mm high	
SATA disk(s)	None	
SATA controller	Serial ATA, SATA 3.0Gb/s, integrated in ICH9R, not used by disks	
SATA connectors	Two SATA connectors on planar, two simple-swap connectors on 3.5" disk backplate	
SATA RAID cont	LSI™ 1064E, SATA 3.0Gb/s, RAID® 0, 1 support, Mini PCI Express® adapter	
SAS disk	Not supported	
SAS connectors	Not supported	
SAS RAID cont	Not supported	
Chipset	Intel 3210 Chipset , Intel I/O Controller Hub 9 RAID (ICH9R) for RAID 0, 1, 10 support, SMSC® SCH5027 Super I/O	
Riser card	Contains one PCI Express x4 slot and one PCI Express x8 slot	
Front ports	Two USB 2.0	
Rear ports	Two USB 2.0, external monitor (VGA DB-15), serial (9-pin), two ethernet (RJ-45), system management (RJ-45)	
Diagnostics	Diagnostic LEDs (system-error LED on front cover; error LEDs for fans, disk controller, memory, PCI slots, power)	
Systems mgmt	System management utility, baseboard management controller, IPMI 2.0-compliant	
Audio	None	
Speaker	Internal speaker	
Ethernet	Dual gigabit on planar, Broadcom® 5722 (PCIe x1), Broadcom 5703 (PCI 2.2), full duplex, Wake on LAN®	
Keyboard	None (use USB port)	
Mouse	None (use USB port)	
Power supply	One 350 watts, one maximum, non-redundant, two variable speed fans, non-hot-swap, universal	
Cooling	Five fans, five maximum, variable speed	
Software management tools		
• ThinkServer EasyStartup • ThinkServer EasyUpdate • ThinkServer EasyManage		
Accessories		
1GB PC2-6400 DDR2 ECC UDIMM	45J6188	
2GB PC2-6400 DDR2 ECC UDIMM	45J6189	
160GB 3.5" Simple-swap SATA 3.0Gb/s Disk (7200 rpm)	45J6195	
250GB 3.5" Simple-swap SATA 3.0Gb/s Disk (7200 rpm)	45J6196	
500GB 3.5" Simple-swap SATA 3.0Gb/s Disk (7200 rpm)	45J6197	
750GB 3.5" Simple-swap SATA 3.0Gb/s Disk (7200 rpm)	45J6198	
Other accessories at lenovo.com/accessories		

See footnotes for important warranty information
US model announced September 30, 2008

© Lenovo
(RS110-1) October 2008

Name	Type-model	Slot x bay	Processor	GHz	Cores	Memory	Disk(s) size	Disk connection	Disk type	RAID controller	EIDE optical	Power supply	Fans	Limited warranty ¹	Workhorse Global	Avail date
RS110	6438-13U	2x3	E3110	3.00	2	1 x 2GB	None 3.5"	2 x Simple-swap	SATA	1064E	Combo	350W	5	3-year	No	Sep 08
RS110	6438-15U	2x5	X3360	2.83	2	2 x 2GB	None 2.5"	4 x Hot-swap	SAS	MR10i	Combo	350W	5	3-year	No	Sep 08

- **R = Rack, S = Single processor**
- **High performance server with rock solid technology and proven hardware design**
- **Easy to use with ThinkServer EasyStartup, EasyUpdate, and EasyManage software**
- **These small and medium business (SMB) models are part of the US TopSeller™ Program**

Processor	One Intel® Xeon® Processor E3110 with dual-core, one maximum, 1333MHz system bus, and 6MB L2 cache or One Intel Xeon Processor X3360 with quad-core, one maximum, 1333MHz system bus, and 12MB L2 cache	<p>1U Rack top</p> <p>Front on 2.5" disk models</p> <p>Front on 3.5" disk models</p> <p>Rear</p> <ul style="list-style-type: none"> • Black color front; metal case • 17.3" W x 22" D x 1.75" H • 440mm W x 559mm D x 43mm H • 28 lb (12.7kg) max configuration • Toolless top cover removal • Toolless disk and optical drive removal • Toolless adapter retention • Illuminated front icons with system error LED <p>Some: 2.5" disk bays:</p> <p>Bay ① 5.25", 0.5" high, external, std optical</p> <p>Bay ② 2.5", 0.6" high, external, optional disk</p> <p>Bay ③ 2.5", 0.6" high, external, optional disk</p> <p>Bay ④ 2.5", 0.6" high, external, optional disk</p> <p>Bay ⑤ 2.5", 0.6" high, external, optional disk</p> <p>Some: 3.5" disk bays:</p> <p>Bay ① 5.25", 0.5" high, external, std optical</p> <p>Bay ② 3.5", 1" high, external, optional disk</p> <p>Bay ③ 3.5", 1" high, external, optional disk</p> <p>PCI Express riser card:</p> <p>Slot 1: 3/4-length, full-height, PCIe x8</p> <p>Slot 2: half-length, low-profile, PCIe x4 (x8 mechanical)</p> <p>Security</p> <ul style="list-style-type: none"> • Power-on password • Administrator password • Boot sequence control • Boot without keyboard, mouse, diskette • Serial port I/O control • USB port disablement (front or all) <p>Software management tools</p> <ul style="list-style-type: none"> • ThinkServer EasyStartup • ThinkServer EasyUpdate • ThinkServer EasyManage <p>ThinkPlus Priority Support, 90-day Trial</p> <p>RoHS-compliant</p>															
Implementation	Processor uses FC-LGA8 package, one LGA775 socket																
Memory	2GB or 4GB std, 8GB max, PC2-6400 800MHz DDR2, ECC , dual-channel capable, four 240-pin DIMM sockets; <i>Non-italics</i> : standard memory in one or two sockets; three or two sockets available																
Graphics	ATI® RN50 (ES1000), on planar, 32-bit/33MHz PCI 2.3, 16MB, external monitor port (VGA DB-15 rear); <i>Maximum resolution: 800x600@85Hz</i>																
EIDE controller	Enhanced IDE controller in Enterprise South Bridge, one connector on planar, single 1-drop IDE cable (for Combo)																
EIDE Combo	DVD-ROM/CD-RW, Ultrabay Enhanced, 12.7mm high																
SATA disk(s)	None																
SATA controller	Serial ATA, SATA 3.0Gb/s, integrated in ICH9R, not used by disks																
SATA connectors	Two SATA connectors on planar, 13U: two simple-swap connectors on 3.5" disk backplate																
SATA RAID cont	13U: LSI™ 1064E, SATA 3.0Gb/s, RAID [®] 0, 1 support, Mini PCI Express [®] adapter																
SAS disk	None																
SAS connectors	15U: 4 hot-swap connectors on 2.5" disk backplane																
SAS RAID cont	15U: LSI MR10i, SAS 3.0Gb/s, RAID [®] 0, 1, 5, 6, 10, 50, 60 support, Mini PCI Express adapter																
Chipset	Intel 3210 Chipset , Intel I/O Controller Hub 9 RAID (ICH9R) for RAID 0, 1, 10 support, SMSC [®] SCH5027 Super I/O																
Riser card	Contains one PCI Express [®] x4 slot and one PCI Express x8 slot																
Front ports	Two USB 2.0																
Rear ports	Two USB 2.0, external monitor (VGA DB-15), serial (9-pin), two ethernet (RJ-45), system management (RJ-45)																
Diagnostics	Diagnostic LEDs (system-error LED on front cover; error LEDs for fans, disk controller, memory, PCI slots, power)																
Systems mgmt	System management utility, baseboard management controller, IPMI 2.0-compliant																
Audio	None																
Speaker	Internal speaker																
Ethernet	Dual gigabit on planar, Broadcom [®] 5722 (PCIe x1), Broadcom 5703 (PCI 2.2), full duplex, Wake on LAN [®]																
Keyboard	None (use USB port)																
Mouse	None (use USB port)																
Power supply	One 350 watts, one maximum, non-redundant, two variable speed fans, non-hot-swap, universal																
Cooling	Five fans, five maximum, variable speed																
Accessories	<table border="0"> <tr> <td>1GB PC2-6400 DDR2 ECC UDIMM</td> <td>45J6188</td> </tr> <tr> <td>2GB PC2-6400 DDR2 ECC UDIMM</td> <td>45J6189</td> </tr> <tr> <td>160GB 3.5" Simple-swap SATA 3.0Gb/s Disk (7200 rpm)</td> <td>45J6195</td> </tr> <tr> <td>250GB 3.5" Simple-swap SATA 3.0Gb/s Disk (7200 rpm)</td> <td>45J6196</td> </tr> <tr> <td>500GB 3.5" Simple-swap SATA 3.0Gb/s Disk (7200 rpm)</td> <td>45J6197</td> </tr> <tr> <td>750GB 3.5" Simple-swap SATA 3.0Gb/s Disk (7200 rpm)</td> <td>45J6198</td> </tr> <tr> <td>73GB 2.5" Hot-swap SAS 3.0Gb/s Disk (15000 rpm)</td> <td>45J6208</td> </tr> <tr> <td>146GB 2.5" Hot-swap SAS 3.0Gb/s Disk (10000 rpm)</td> <td>45J6207</td> </tr> </table> <p>Other accessories at lenovo.com/accessories</p>	1GB PC2-6400 DDR2 ECC UDIMM	45J6188	2GB PC2-6400 DDR2 ECC UDIMM	45J6189	160GB 3.5" Simple-swap SATA 3.0Gb/s Disk (7200 rpm)	45J6195	250GB 3.5" Simple-swap SATA 3.0Gb/s Disk (7200 rpm)	45J6196	500GB 3.5" Simple-swap SATA 3.0Gb/s Disk (7200 rpm)	45J6197	750GB 3.5" Simple-swap SATA 3.0Gb/s Disk (7200 rpm)	45J6198	73GB 2.5" Hot-swap SAS 3.0Gb/s Disk (15000 rpm)	45J6208	146GB 2.5" Hot-swap SAS 3.0Gb/s Disk (10000 rpm)	45J6207
1GB PC2-6400 DDR2 ECC UDIMM	45J6188																
2GB PC2-6400 DDR2 ECC UDIMM	45J6189																
160GB 3.5" Simple-swap SATA 3.0Gb/s Disk (7200 rpm)	45J6195																
250GB 3.5" Simple-swap SATA 3.0Gb/s Disk (7200 rpm)	45J6196																
500GB 3.5" Simple-swap SATA 3.0Gb/s Disk (7200 rpm)	45J6197																
750GB 3.5" Simple-swap SATA 3.0Gb/s Disk (7200 rpm)	45J6198																
73GB 2.5" Hot-swap SAS 3.0Gb/s Disk (15000 rpm)	45J6208																
146GB 2.5" Hot-swap SAS 3.0Gb/s Disk (10000 rpm)	45J6207																
Limited Warranty¹																	
<ul style="list-style-type: none"> ↪ 3-year parts and labor ↪ Customer Replaceable Unit (CRU) parts only (with limited onsite service for selected parts³, 8 am - 5 pm, Mon - Fri coverage excluding holidays, next business day response time) ↪ ThinkPlus™ services available; see lenovo.com/thinkplus/warranty <ul style="list-style-type: none"> • Onsite service upgrade options (in eligible locations)⁷ • Post warranty maintenance services ↪ 24 hour x 7 day¹⁴ toll-free support during the warranty period¹ via 800-426-7378 																	

See footnotes for important warranty information
US models announced September 30, 2008



Lenovo ThinkServer RD120

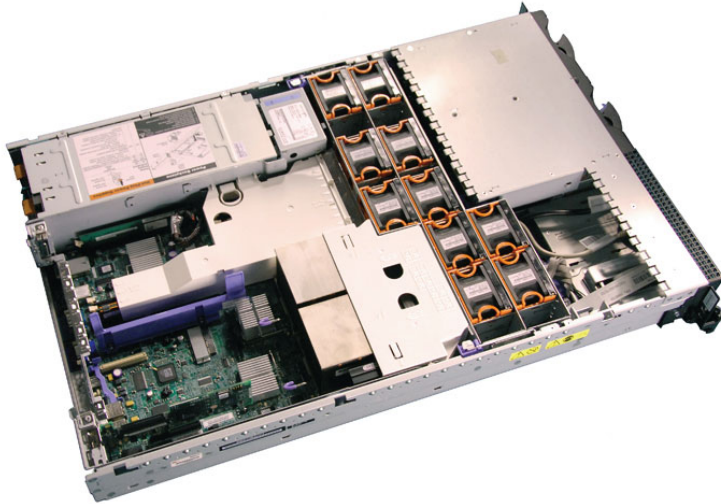

Lenovo ThinkServer RD120



Lenovo ThinkServer RD120



Lenovo ThinkServer RD120



Lenovo ThinkServer RD120

Name	Type-model	Slot x bay	Processor(s)	GHz	Cores	Memory	Disk(s)	size	Disk connection	Disk type	RAID controller	EIDE optical	Power supply(s)	Limited Fans	Workhorse warranty ¹	Global	Avail date
RD120	6445-12U	4x7	1 x E5205	1.86	2	2 x 1GB	None	3.5"	6 x Hot-swap	SATA/SAS ⁴	RAID-8k	Combo	2 x 835W	10	1-year	No	Sep 08

- **R = Rack, D = Dual processor support**
- **High performance server with rock solid technology and proven hardware design**
- **Easy to use with ThinkServer EasyStartup, EasyUpdate, and EasyManage software**
- **These small and medium business (SMB) models are part of the US TopSeller™ Program**

Processor	One Intel® Xeon® Processor E5205 with dual-core, two maximum, 1066MHz system bus, and 6MB L2 cache
Implementation	Processor uses FC-LGA6 package, two LGA771 sockets
Memory	2GB std, 48GB max, PC2-5300 667MHz DDR2, Advanced ECC , fully buffered, 4-channel capable, twelve 240-pin DIMM sockets; <i>Non-italics</i> : standard memory in two sockets; ten sockets available
Graphics	ATI® RN50 (ES1000), on planar, 32-bit/33MHz PCI 2.3, 16MB, external monitor port (two VGA DB-15 front and rear); <i>Maximum resolution</i> : 800x600@85Hz
EIDE controller	Enhanced IDE controller in Enterprise South Bridge, one connector on planar, single 1-drop IDE cable (for Combo)
EIDE Combo	DVD-ROM/CD-RW, Ultrabay Enhanced, 12.7mm high
SATA disk(s)	None
SATA connectors	Six hot-swap connectors on 3.5" disk backplane
SAS disk(s)	None
SATA/SAS ⁴ cont	Adaptec® AIC-9580W, SATA 3.0Gb/s, SAS 3.0Gb/s, RAID® 0, 1, 10 support, 8-port, on planar, not used
SAS connectors	Six hot-swap connectors on 3.5" disk backplane
SATA/SAS RAID controller	RAID-8k Adapter, SATA 3.0Gb/s, SAS 3.0Gb/s, RAID® 0, 1, 5, 10, 50, 60 support, in reserved connector, single cable to backplane
Chipset	Intel 5000P chipset , Intel 6321ESB-2E I/O Controller Hub, NS PC8742XVUL Super I/O
Riser card	Contains two PCI Express® x8 slots
Front ports	Two USB 2.0, external monitor (VGA DB-15)
Rear ports	Four USB 2.0, external monitor (VGA DB-15), serial (9-pin), two ethernet (RJ-45), system management (RJ-45), external SAS
Diagnostics	Easy LED Diagnostics (pull-out operator information panel with information LED and system-error LED; error LEDs for fans, disks, RAID, memory, processors, voltage regulator module, riser card, PCI slots, power supplies)
Systems mgmt	System management utility, baseboard management controller, IPMI 2.0-compliant
Audio	None
Speaker	Internal speaker
Ethernet	Dual gigabit on planar, two Broadcom® 5708, PCIe x1, full duplex, Wake on LAN®, TCP/IP Offload Engine (TOE), Alert Standard Format 2.0
Keyboard	None (use USB port)
Mouse	None (use USB port)
Power supply	Two 835 watts, two maximum, redundant with 2, variable speed fan, hot-swap, universal, two redundant power supplies require ten fans
Cooling	Ten fans, ten maximum, variable speed, hardware failure protection, hot-swap, ten fans required with second redundant power supply

2U Rack top

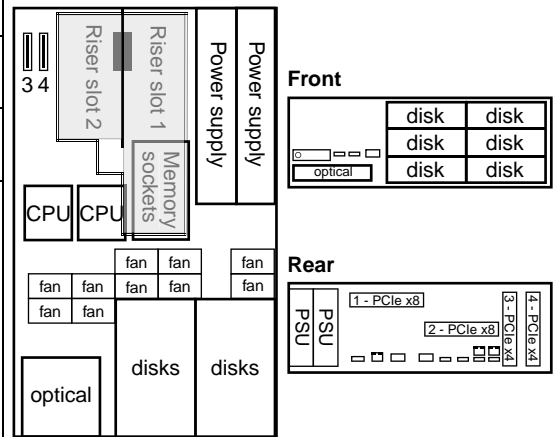

- Black color front; metal case
 - 17.5"W x 27.8"D x 3.36"H
 - 443.6mm W x 705mm D x 85.4mm H
 - 65 lb (29.5kg) max configuration
 - Toolless top cover removal
 - Toolless disk and optical drive removal
 - Toolless adapter retention
 - Illuminated front icons with pull-out Easy LED Diagnostics panel
- Bay ① 5.25", 0.5" high, external, std optical
 Bay ② 3.5", 1" high, external, optional disk
 Bay ③ 3.5", 1" high, external, opt disk (opt 1.6" tape)
 Bay ④ 3.5", 1" high, external, opt disk (used by tape)
 Bay ⑤ 3.5", 1" high, external, optional disk
 Bay ⑥ 3.5", 1" high, external, optional disk
 Bay ⑦ 3.5", 1" high, external, optional disk
- Slot 1: full-length, full-height, PCIe x8 (*on riser card*)
 Slot 2: half-length, full-height, PCIe x8 (*on riser card*)
 Slot 3: half-length, low-profile, PCIe x4 (x8 mechanical)
 Slot 4: half-length, low-profile, PCIe x4 (x8 mechanical)

Accessories

Intel Xeon Quad-Core Processor E5205	45J6180
1GB PC2-5300 DDR2 ECC FB-DIMM	45J6191
2GB PC2-5300 DDR2 ECC FB-DIMM	45J6192
4GB PC2-5300 DDR2 ECC FB-DIMM	45J6193
500GB 3.5" Hot-swap SATA 3.0Gb/s Disk (7200 rpm)	45J6202
750GB 3.5" Hot-swap SATA 3.0Gb/s Disk (7200 rpm)	45J6203
1TB 3.5" Hot-swap SATA 3.0Gb/s Disk (7200 rpm)	45J6204
146GB 3.5" Hot-swap SAS 3.0Gb/s Disk (15000 rpm)	45J6211
300GB 3.5" Hot-swap SAS 3.0Gb/s Disk (15000 rpm)	45J6212
Other accessories at lenovo.com/accessories	

Limited Warranty¹

- ↪ **1-year parts and labor**
- ↪ **Customer Replaceable Unit (CRU) parts only (with limited onsite service for selected parts³, 8 am - 5 pm, Mon - Fri coverage excluding holidays, next business day response time)**
- ↪ **ThinkPlus™ services available; see lenovo.com/thinkplus/warranty**
 - Onsite service upgrade options (in eligible locations)⁷
 - Post warranty maintenance services
- ↪ **24 hour x 7 day¹⁴ toll-free support during the warranty period¹ via 800-426-7378**

Security

- Power-on password
- Administrator password
- Boot sequence control
- Boot without keyboard, mouse, diskette
- Serial port I/O control
- USB port disablement (front or all)

Software management tools

- ThinkServer EasyStartup
- ThinkServer EasyUpdate
- ThinkServer EasyManage

ThinkPlus Priority Support, 90-day Trial

RoHS-compliant

See footnotes for important warranty information
 US models announced September 30, 2008

Name	Type-model	Slot x bay	Proc-essor(s)	GHz Cores	Memory	Disk(s)	Disk size	Disk connection	Disk type	RAID controller	EIDE optical	Power supply(s)	Fans	Limited warranty ¹	Workhorse Global	Avail date
RD120	6447-18U	4x7	1 x E5410	2.33	4	2 x 1GB	None	3.5"	6 x Hot-swap	SATA/SAS ⁴	RAID-8k	Combo 2 x 835W	10	3-year	No	Sep 08
RD120	6447-21U	4x7	1 x E5430	2.66	4	2 x 2GB	None	3.5"	6 x Hot-swap	SATA/SAS ⁴	RAID-8k	Combo 2 x 835W	10	3-year	No	Sep 08
RD120	6447-23U	4x10	2 x E5450	3.00	4	2 x 2GB	None	2.5"	8 x Hot-swap	SAS	RAID-8k	Combo 2 x 835W	10	3-year	No	Sep 08

• R = Rack, D = Dual processor support
 • High performance server with rock solid technology and proven hardware design
 • Easy to use with ThinkServer EasyStartup, EasyUpdate, and EasyManage software
 • These small and medium business (SMB) models are part of the US TopSeller™ Program

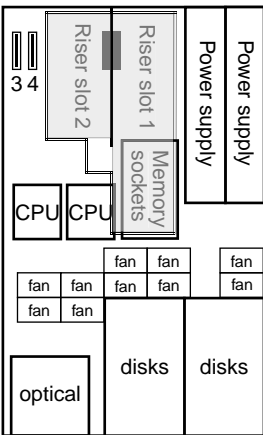
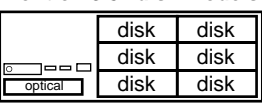
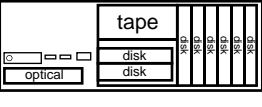
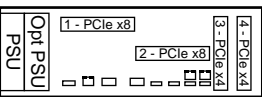
Processor	One or two Intel® Xeon® Processor E5410, E5430, or E5450 with quad-core, two maximum, 1333MHz bus, and 12MB L2 cache	2U Rack top  Front on 3.5" disk models  Front on 2.5" disk models  Rear 																			
Implementation	Processor uses FC-LGA6 package, two LGA771 sockets																				
Memory	2GB or 4GB std, 48GB max, PC2-5300 667MHz DDR2, Advanced ECC, fully buffered, 4-channel capable, twelve 240-pin DIMM sockets; <i>Non-italics</i> : standard memory in two sockets; ten sockets available																				
Graphics	ATI® RN50 (ES1000), on planar, 32-bit/33MHz PCI 2.3, 16MB, external monitor port (two VGA DB-15 front and rear); <i>Maximum resolution</i> : 800x600@85Hz																				
EIDE controller	Enhanced IDE controller in Enterprise South Bridge, one connector on planar, single 1-drop IDE cable (for DVD)																				
EIDE Combo	DVD-ROM/CD-RW, Ultrabay Enhanced, 12.7mm high																				
SATA disk(s)	None																				
SATA connectors	18U/21U: six hot-swap connectors on 3.5" disk backplane																				
SAS disk(s)	None																				
SATA/SAS ⁴ cont	Adaptec® AIC-9580W, SATA 3.0Gb/s, SAS 3.0Gb/s, RAID ⁵ 0, 1, 10 support, 8-port, on planar, not used																				
SAS connectors	18U/21U: six hot-swap connectors on 3.5" disk backplane																				
SATA/SAS RAID controller	23U: eight hot-swap connectors on 2.5" disk backplane RAID-8k Adapter, SATA 3.0Gb/s, SAS 3.0Gb/s, RAID ⁵ 0, 1, 5, 10, 50, 60 support, in reserved connector, single cable to backplane																				
Chipset	Intel 5000P chipset, Intel 6321ESB-2E I/O Controller Hub, NS PC8742XVUL Super I/O																				
Riser card	Contains two PCI Express® x8 slots																				
Front ports	Two USB 2.0, external monitor (VGA DB-15)																				
Rear ports	Four USB 2.0, external monitor (VGA DB-15), serial (9-pin), two ethernet (RJ-45), system management (RJ-45), external SAS																				
Diagnostics	Easy LED Diagnostics (pull-out operator information panel with information LED and system-error LED; error LEDs for fans, disks, RAID, memory, processors, voltage regulator module, riser card, PCI slots, power supplies)																				
Systems mgmt	System management utility, baseboard management controller, IPMI 2.0-compliant																				
Audio	None																				
Speaker	Internal speaker																				
Ethernet	Dual gigabit on planar, two Broadcom® 5708, PCIe x1, full duplex, Wake on LAN®, TCP/IP Offload Engine (TOE), Alert Standard Format 2.0																				
Keyboard	None (use USB port)																				
Mouse	None (use USB port)																				
Power supply	Two 835 watts, two maximum, redundant with 2, variable speed fan, hot-swap, universal, two redundant power supplies require ten fans																				
Cooling	Ten fans, ten maximum, variable speed, hardware failure protection, hot-swap, ten fans required with second redundant power supply																				
Accessories	<table border="0"> <tr><td>Intel Xeon Quad-Core Processor E5410</td><td>45J6185</td></tr> <tr><td>Intel Xeon Quad-Core Processor E5430</td><td>45J6186</td></tr> <tr><td>1GB PC2-5300 DDR2 ECC FB-DIMM</td><td>45J6191</td></tr> <tr><td>2GB PC2-5300 DDR2 ECC FB-DIMM</td><td>45J6192</td></tr> <tr><td>4GB PC2-5300 DDR2 ECC FB-DIMM</td><td>45J6193</td></tr> <tr><td>750GB 3.5" Hot-swap SATA 3.0Gb/s Disk (7200 rpm)</td><td>45J6203</td></tr> <tr><td>1TB 3.5" Hot-swap SATA 3.0Gb/s Disk (7200 rpm)</td><td>45J6204</td></tr> <tr><td>146GB 2.5" Hot-swap SAS 3.0Gb/s Disk (10000 rpm)</td><td>45J6207</td></tr> <tr><td>146GB 3.5" Hot-swap SAS 3.0Gb/s Disk (15000 rpm)</td><td>45J6211</td></tr> <tr><td>300GB 3.5" Hot-swap SAS 3.0Gb/s Disk (15000 rpm)</td><td>45J6212</td></tr> </table> Other accessories at lenovo.com/accessories	Intel Xeon Quad-Core Processor E5410	45J6185	Intel Xeon Quad-Core Processor E5430	45J6186	1GB PC2-5300 DDR2 ECC FB-DIMM	45J6191	2GB PC2-5300 DDR2 ECC FB-DIMM	45J6192	4GB PC2-5300 DDR2 ECC FB-DIMM	45J6193	750GB 3.5" Hot-swap SATA 3.0Gb/s Disk (7200 rpm)	45J6203	1TB 3.5" Hot-swap SATA 3.0Gb/s Disk (7200 rpm)	45J6204	146GB 2.5" Hot-swap SAS 3.0Gb/s Disk (10000 rpm)	45J6207	146GB 3.5" Hot-swap SAS 3.0Gb/s Disk (15000 rpm)	45J6211	300GB 3.5" Hot-swap SAS 3.0Gb/s Disk (15000 rpm)	45J6212
Intel Xeon Quad-Core Processor E5410	45J6185																				
Intel Xeon Quad-Core Processor E5430	45J6186																				
1GB PC2-5300 DDR2 ECC FB-DIMM	45J6191																				
2GB PC2-5300 DDR2 ECC FB-DIMM	45J6192																				
4GB PC2-5300 DDR2 ECC FB-DIMM	45J6193																				
750GB 3.5" Hot-swap SATA 3.0Gb/s Disk (7200 rpm)	45J6203																				
1TB 3.5" Hot-swap SATA 3.0Gb/s Disk (7200 rpm)	45J6204																				
146GB 2.5" Hot-swap SAS 3.0Gb/s Disk (10000 rpm)	45J6207																				
146GB 3.5" Hot-swap SAS 3.0Gb/s Disk (15000 rpm)	45J6211																				
300GB 3.5" Hot-swap SAS 3.0Gb/s Disk (15000 rpm)	45J6212																				
Software management tools	• ThinkServer EasyStartup • ThinkServer EasyUpdate • ThinkServer EasyManage																				
Limited Warranty¹	• 3-year parts and labor • Customer Replaceable Unit (CRU) parts only (with limited onsite service for selected parts ³ , 8 am - 5 pm, Mon - Fri coverage excluding holidays, next business day response time) • ThinkPlus™ services available; see lenovo.com/thinkplus/warranty • Onsite service upgrade options (in eligible locations) ⁷ • Post warranty maintenance services • 24 hour x 7 day ¹⁴ toll-free support during the warranty period ¹ via 800-426-7378																				
Security	• Power-on password • Administrator password • Boot sequence control • Boot without keyboard, mouse, diskette • Serial port I/O control • USB port disablement (front or all)																				
	ThinkPlus Priority Support, 90-day Trial																				
	RoHS-compliant																				

• Black color front; metal case
 • 17.5"W x 27.8"D x 3.36"H
 • 443.6mm W x 705mm D x 85.4mm H
 • 65 lb (29.5kg) max configuration
 • Toolless top cover removal
 • Toolless disk and optical drive removal
 • Toolless adapter retention
 • Illuminated front icons with pull-out
 • Easy LED Diagnostics panel

Some: 2.5" disk bays:
 Bay ① 5.25", 0.5" high, external, std optical
 Bay ② 3.5", 1.6" high, external, optional tape
 Bay ③ 2.5", 0.6" high, external, optional disk
 Bay ④ 2.5", 0.6" high, external, optional disk
 Bay ⑤ 2.5", 0.6" high, external, optional disk
 Bay ⑥ 2.5", 0.6" high, external, optional disk
 Bay ⑦ 2.5", 0.6" high, external, optional disk
 Bay ⑧ 2.5", 0.6" high, external, optional disk
 Bay ⑨ 2.5", 0.6" high, external, optional disk
 Bay ⑩ 2.5", 0.6" high, external, optional disk

Some: 3.5" disk bays:
 Bay ① 5.25", 0.5" high, external, std optical
 Bay ② 3.5", 1" high, external, optional disk
 Bay ③ 3.5", 1" high, external, opt disk (opt 1.6" tape)
 Bay ④ 3.5", 1" high, external, opt disk (used by tape)
 Bay ⑤ 3.5", 1" high, external, optional disk
 Bay ⑥ 3.5", 1" high, external, optional disk
 Bay ⑦ 3.5", 1" high, external, optional disk

Slot 1: full-length, full-height, PCIe x8 (on riser card)
 Slot 2: half-length, full-height, PCIe x8 (on riser card)
 Slot 3: half-length, low-profile, PCIe x4 (x8 mechanical)
 Slot 4: half-length, low-profile, PCIe x4 (x8 mechanical)

See footnotes for important warranty information
 US models announced September 30, 2008

Partial list of accessories supported on Lenovo® ThinkServer

ThinkServer Ready accessories are available through Lenovo Business Partners. Locate a Business Partner near you at: bplocator.lenovo.com

Storage

USB Portable Diskette Drive 05K9276 *ann 06/05/00*

Keyboard

Preferred Pro USB Keyboard 73P5220 *ann 06/21/05*
 USB Travel Keyboard with UltraNav 31P9490 *ann 04/27/04*

Mouse

Optical Wheel Mouse (USB) 06P4069 *ann 05/21/03*

Monitors

ThinkVision® L151 15" LCD Monitor 9165AC6 *ann 10/23/07*
 ThinkVision L171p 17" LCD Monitor 9227AD1 *ann 10/31/06*
 ThinkVision L193p 19" LCD Monitor 4431HB2 *ann 10/23/07*

Other accessories at www.lenovo.com/thinkserver/options

Operating Systems

Microsoft® Windows®

English language

Server 2008 Standard ROK	54Y6100
Server 2008 Enterprise ROK	54Y6110
Server 2008 Datacenter (64-bit) ROK	84979HE
Small Business Server 2003 R2, Standard Edition ROK	54Y6119
Small Business Server 2003 R2, Premium Edition ROK	54Y6128
Server 2003 R2, 32-bit Enterprise Edition ROK	55Y7017
Server 2003 R2, Enterprise x64 Edition ROK	55Y7027
Server 2003 R2, Standard Edition ROK	55Y7000
Server 2003 R2, Standard x64 Edition, ROK	55Y7010

French language

Server 2008 Standard ROK	54Y6103
Server 2008 Enterprise ROK	54Y6112
Server 2008 Datacenter (64-bit) ROK	84979HF
Small Business Server 2003 R2, Standard Edition ROK	54Y6121
Small Business Server 2003 R2, Premium Edition ROK	54Y6130
Server 2003 R2, 32-bit Enterprise Edition ROK	55Y7021
Server 2003 R2, Enterprise x64 Edition ROK	55Y7033
Server 2003 R2, Standard Edition ROK	55Y7006
Server 2003 R2, Standard x64 Edition, ROK	55Y7016

Spanish language

Server 2008 Standard ROK	54Y6108
Server 2008 Enterprise ROK	54Y6117
Server 2008 Datacenter (64-bit) ROK	84979HS
Small Business Server 2003 R2, Standard Edition ROK	54Y6126
Small Business Server 2003 R2, Premium Edition ROK	54Y6135
Server 2003 R2, 32-bit Enterprise Edition ROK	55Y7025
Server 2003 R2, Enterprise x64 Edition ROK	55Y7030
Server 2003 R2, Standard Edition ROK	55Y7005
Server 2003 R2, Standard x64 Edition, ROK	55Y7013

Novell® Server Software - SLES for Lenovo

SLES = SUSE® Linux™ Enterprise Server

1-year SLES plus 1-year Standard support	55Y7037
1-year SLES plus 1-year Priority support	55Y7038
3-year SLES plus 3-year Standard support	55Y7039
3-year SLES plus 3-year Priority support	55Y7040

Partial list of Lenovo® ThinkPlus Services for ThinkServer™

For more information see:

http://www.lenovo.com/services_warranty/us/en/index.html

Training classes

- The basics on components, diagnostics, troubleshooting, and managing Lenovo servers, delivered in interactive online format

Online Training, Understanding Lenovo Servers	45K4080
Online Training, Understanding Systems Management	45K4081
Installation, ThinkServer Hardware Only	45K4082

ThinkPlus service upgrade options⁷

LOR = *Lenovo Onsite Repair*

TS100 with 1-year warranty	
3-year LOR 9x5 Next Business Day	45K4055
3-year LOR 9x5 4 hour response	45K4056
TS100 with 3-year warranty	
3-year LOR 9x5 4 hour response	45K4059
TD100 with 1-year warranty	
3-year LOR 9x5 Next Business Day	45K4062
3-year LOR 9x5 4 hour response	45K4063
TD100 with 3-year warranty	
3-year LOR 9x5 4 hour response	45K4066
RS110 with 1-year warranty	
3-year LOR, 9x5 Next Business Day	45K4069
3-year LOR, 4 hour response	45K4070
RS110 with 3-year warranty	
3-year LOR, 4 hour response	45K4073
RD120 with 1-year warranty	
3-year LOR 9x5 Next Business Day	45K5305
3-year LOR 9x5 4 hour response	45K5306
RD120 with 3-year warranty	
3-year LOR 9x5 4 hour response	45K4076

ThinkPlus Priority Support

- 9x5 Next Business Day response Lenovo Onsite Repair
- 24 x 7 support with priority routing and advanced level technicians

TS100 with 1-year warranty	
3-year Priority Support	45K4057
3-year Priority Support 4 hour response	45K4058
TS100 with 3-year warranty	
3-year Priority Support	45K4060
3-year Priority Support 4 hour response	45K4061
TD100 with 1-year warranty	
3-year Priority Support	45K4064
3-year Priority Support 4 hour response	45K4065
TD100 with 3-year warranty	
3-year Priority Support	45K4067
3-year Priority Support 4 hour response	45K4068
RS110 with 1-year warranty	
3-year Priority Support	45K4071
3-year Priority Support 4 hour response	45K4072
RS110 with 3-year warranty	
3-year Priority Support	45K4074
3-year Priority Support 4 hour response	45K4075
RD120 with 1-year warranty	
3-year Priority Support	45K5307
3-year Priority Support 4 hour response	45K5308
RD120 with 3-year warranty	
3-year Priority Support	45K4077
3-year Priority Support 4 hour response	45K4078

ThinkPlus Priority Support with Hard Disk Drive Retention

- 9x5 Next Business Day response Lenovo Onsite Repair
- 24x7 support with priority routing and advanced level technicians
- Hard Disk Drive Retention (HDDR) means customer keeps disk

HDDR = Hard Disk Drive Retention

TS100 with 1-year warranty	
3-year Priority Support with HDDR	45K5441
3-year Priority Support 4 hour response with HDDR	45K5442
TS100 with 3-year warranty	
3-year Priority Support with HDDR	45K5443
3-year Priority Support 4 hour response with HDDR	45K5444
TD100 with 1-year warranty	
3-year Priority Support with HDDR	45K5445
3-year Priority Support 4 hour response with HDDR	45K5446
TD100 with 3-year warranty	
3-year Priority Support with HDDR	45K5447
3-year Priority Support 4 hour response with HDDR	45K5448
RS110 with 1-year warranty	
3-year Priority Support with HDDR	45K5449
3-year Priority Support 4 hour response with HDDR	45K5450
RS110 with 3-year warranty	
3-year Priority Support with HDDR	45K5451
3-year Priority Support 4 hour response with HDDR	45K5452
RD120 with 1-year warranty	
3-year Priority Support with HDDR	45K5453
3-year Priority Support 4 hour response with HDDR	45K5454
RD120 with 3-year warranty	
3-year Priority Support with HDDR	45K5455
3-year Priority Support 4 hour response with HDDR	45K5456

ThinkPlus Productivity

- Priority Support
- Online Training, Understanding Lenovo Servers
- One-time hardware installation

3-year ThinkPlus Productivity, TS100 (1-year)	45K4084
3-year ThinkPlus Productivity, TS100 (3-year)	45K4086
3-year ThinkPlus Productivity, TD100 (1-year)	45K4088
3-year ThinkPlus Productivity, TD100 (3-year)	45K4090
3-year ThinkPlus Productivity, RS110 (1-year)	45K4092
3-year ThinkPlus Productivity, RS110 (3-year)	45K4094
3-year ThinkPlus Productivity, RD120 (1-year)	45K5315
3-year ThinkPlus Productivity, RD120 (3-year)	45K4096

Lenovo Online Data Backup

- Secure offsite data storage
- 256-bit Advanced Encryption System
- Data recovery or access in case of an unforeseen event
- Automatic, remote management
- Choose which business critical data to back up

1-year 25GB Server Lenovo Online Data Backup (US)	45K2115
1-year 50GB Server Lenovo Online Data Backup (US)	45K2116
1-year 100GB Server Lenovo Online Data Backup (US)	45K2117

Availability: All offers subject to availability. Lenovo reserves the right to alter product offerings and specifications at any time, without notice. Lenovo is not responsible for photographic or typographic errors.

Warranty: For a copy of applicable product warranties, write to: Warranty Information, 500 Park Offices Drive, RTP, NC, 27709, Attn: Dept ZPYA/B600. Lenovo makes no representation or warranty regarding third party products or services.

- ¹ **Limited warranty:** Support unrelated to a warranty issue may be subject to additional charges.
- ² **Hard drive:** GB = billion bytes, TB = trillion bytes. Accessible capacity is less.
- ³ **Systems with limited onsite service** are designed to be repaired during the applicable warranty period primarily with customer-replaceable parts provided by Lenovo. Lenovo will only send a technician onsite to perform a repair if (a) remote telephone diagnosis and/or customer part replacement are unable to resolve the problem, or (b) the part is one of the few designated by Lenovo for onsite replacement. For a list of onsite replaceable parts, contact Lenovo. In the United States call 1-800-426-7378. Support unrelated to a warranty issue may be subject to additional charges.
- ⁴ **SATA/SAS:** The system configuration supports the installation of either SATA or SAS disks. A configuration including both SATA and SAS disks is not supported.
- ⁷ **ThinkPlus Services:** These services are available for machines normally used for business, professional, or trade purposes, rather than personal, family, or household purposes. Not all machine types and models are covered. Service period begins with the equipment date of purchase. Service must be purchased during the original limited product warranty period. Service levels are response time objectives and are not guarantees. If the machine problem turns out to be a Customer Replaceable Unit (CRU), a part will be express shipped to you for quick replacement. Onsite 24x7x2-hour service is not available in all locations. P&L means parts and labor. P/U means pick-up. See ThinkPlus terms and conditions for complete details and restrictions.

⁸ **RAID:** Supported RAID levels for a system will vary from the stated capabilities of the RAID controller due to dependencies on the number and capacity of physical disks in the system and on customer requirements for performance, fault tolerance, or data redundancy.

RAID levels and requirements:

- **RAID 0 (striping)** provides increased performance by writing data across multiple drives.
- **RAID 1 (mirroring)** provides fault tolerance by writing the data on two drives.
- **RAID 5 (striping with parity)** uses distributed parity data to provide fault tolerance more efficiently than RAID 1. Requires three or more drives.
- **RAID 6 (striped set with dual distributed parity)** provides fault tolerance from two drive failures; array continues to operate with up to two failed drives. Requires four drives.
- **RAID 10 (or RAID 1+0)** combines RAID 1 and RAID 0 to create a stripe of mirrors that is fault tolerant while offering increased performance. Requires four drives.
- **RAID 50 (or RAID 5+0)** combines RAID 5 and RAID 0 to create block-level striping with distributed parity improving performance over RAID 5. Requires six drives.
- **RAID 60 (or RAID 6+0)** combines RAID 6 and RAID 0 to create block-level striping with distributed double parity improving performance over RAID 6. Requires eight drives.

¹⁴ **Response times may vary.** May exclude some holidays. Telephone support may be subject to additional charges.

ThinkServer™

This publication was developed for products and services offered in the United States. Lenovo may not offer the products, services or features discussed in this document in other countries. Lenovo may withdraw an offering at any time. Information is subject to change without notice. Consult your local representative for information on offerings available in your area.

Lenovo reserves the right to change specifications and other product information at any time without prior notice. Lenovo is not responsible for photographic or typographical errors. LENOVO PROVIDES THIS PUBLICATION "AS IS" WITHOUT WARRANTY OF ANY KIND, EITHER EXPRESS OR IMPLIED, INCLUDING THE IMPLIED WARRANTIES OF MERCHANTABILITY OR FITNESS FOR A PARTICULAR PURPOSE. Some jurisdictions do not allow disclaimer of express or implied warranties in certain transactions; therefore this disclaimer may not apply to you.

Trademarks: Lenovo, the Lenovo logo, New World. New Thinking., Access Connections, Rescue and Recovery, ThinkCentre, ThinkPad, ThinkServer, ThinkStation, ThinkVantage, and ThinkVision are trademarks of Lenovo. Microsoft, Windows, and Vista are registered trademarks of Microsoft Corporation. Intel, the Intel logo, Intel Inside logo, Intel Core and Core Inside are trademarks of Intel Corporation in the US and other countries. Other company, product, or service names may be trademarks or service marks of others.

Visit lenovo.com/safecomputing periodically for the latest information on safe and effective computing.

© Lenovo, 2009.
All rights reserved.

Lenovo
1009 Think Place
Morrisville, NC 27560
U.S.A.

December 2008
svbook.pdf

ThinkVision®

Personal Systems Reference ThinkVision Monitors

December 2008 - Version 349



ThinkVision L2440x Wide Monitor

lenovo.com

E Series Essential CRT Monitors		Positioning
Name Case color Type-model Stand Screen Viewable image size Aspect ratio Dot pitch Max view area (inches) Max view area (mm) CRT type Video input	Lenovo E75 CRT Monitor Business black 6307-BTN Tilt, swivel stand 17.0" (432mm) FST CRT 16.0" / 406mm (diagonal) 4x3 0.25mm 12.8" x 9.6" (horizontal x vertical) 325mm x 244mm (horizontal x vertical) Full Flat Shadow Mask (FST) Analog	• The Lenovo E75 CRT monitor is an essential monitor offering standard business features for value-conscious customers.
Vertical refresh rate range Horizontal line rate range Clock rate	50 to 160Hz 30 to 72kHz 110Mpels/sec (MHz)	Features <ul style="list-style-type: none"> • 17-inch (432mm) CRT with a viewable image size of 16.0" (406mm) incorporating a 0.25 dot pitch • Flatter, squarer tube (FST) cathode ray tube (CRT) design • Recommended for use at maximum resolution of 1024x768 at 85Hz for flicker-free viewing • Anti-reflective screen treatments to minimize glare without sacrificing picture sharpness
Optimum resolution Maximum resolution Preset display modes	1024x768 at 85Hz 1280x1024 at 60Hz VGA: 640x480 60, 85Hz 720x400 70Hz SVGA: 800x600 75, 85Hz XGA: 1024x768 75, 85Hz 1152x864 75Hz SXGA: 1280x1024 60Hz	
Presets / user settings	9 / 8	
On screen display On screen display controls Control features	Yes (6 languages) Digital front panel controls Contrast/brightness, horizontal/vertical size/centering, pincushion, pincushion balance, image rotation, geometry recall, degauss, color point adjustment, R/G/B control, color point recall, selectable color points, picture zoom, moire control, parallelogram, trapezoid, display time	
Connector Signal cable Power cable Anti-reflective treatment Anti-static treatment Dimensions (H x W x D) Dimensions (H x W x D) Weight Stand	VGA 15-pin D-shell One 1.5 meter captive with VGA 15-pin D-shell 1.8 meter Yes Yes 15.0" x 15.6" x 16.9" 381mm x 397mm x 430mm 33.5 lb / 15.2 kg Tilt-swivel stand / tilt: 15° back, 5° forward / swivel: 90° left, 90° right	
VESA DDC VESA DPMS-compliant ENERGY STAR³ Emission standards TCO 99-compliant ISO 9241 capable RoHS Ship group	2B / CI DPMS No MPR-II, FCC-B No Parts 3, 7, 8 ¹ RoHS (EU Directive 2002/95/EC) Monitor, attachable stand, Setup Guide, Safety and Warranty Information, CD with multilingual User's Guide and monitor installation files, attached analog signal cable, separate 1.8m black power cable	
Power supply Limited warranty⁴ Available date	90-264Vac, 75 watts maximum, 50-60Hz, universal 3-year January 2007	
Limited Warranty ⇨ 3-year limited warranty⁴ ⇨ International Warranty Service⁵ ⇨ Rapid Replacement Service at 1-800-IBM-SERV (426-7378) ⇨ Replacement normally arrives in two business days, excluding holidays ⇨ Lenovo pays all shipping costs for valid warranty claims⁶ ⇨ Service upgrade options:⁷ <ul style="list-style-type: none"> • 3-year, on site exchange, Mon-Fri 9-5 with next day response (ThinkPlus™ 41C9209) • 3-year, on site exchange 7 day x 24 hr with 4 hour response (ThinkPlus 41C9212) • 4-year, on site exchange Mon-Fri 9-5 with next day response (ThinkPlus 41C9217) • 4-year, on site exchange 7 day x 24 hr with 4 hour response (ThinkPlus 41C9218) ⇨ 24x7⁸ day toll-free support for warranty issues during the warranty period⁴	E Series Essential CRT Monitors provide essential features at attractive prices Accessories ThinkPad® Convertible Monitor Stand 40Y7620 See details at www.lenovo.com/support/monitoraccessories See all monitors at www.lenovo.com/thinkvision	

See footnotes for important warranty information
 US model announced January 16, 2007

<p>Name D156 Wide Flat Panel Monitor Case color Business black Type-model 4415-AB1 Panel TFT-LCD, twisted nematic (TN) Viewable image size 15.6" (396.2mm) diagonal Max view area (W x H) 13.6" x 7.6" / 344.2mm x 193.5mm Optimum resolution 1366x768 at 60Hz Maximum resolution 1366x768 at 60Hz (135MHz max pixel rate) Aspect ratio 16:9 Pixel pitch (mm) .252mm Brightness 250 nits or cd/m² (typical) Contrast ratio 500:1 (typical) Pixel response time 8ms (typical) Color gamut 65% Anti-reflective Anti-reflective, anti-glare Vertical frequency 50 to 75Hz Horizontal frequency 30 to 60Hz Viewing angle at 10:1 CR 90° (+/- 45°) horizontal, 65° (+20/- 45°) vertical Viewing angle at 5:1 CR 110° (+/- 55°) horizontal, 85° vertical Stand Tilt adjustable stand Bezel width Sides: 0.60" (15.8mm); top: 0.65" (16.5mm); bottom: 1.25" (31.8mm) Dimensions (HxWxD) 9.51-11.76" H x 14.72" W x 2.61-7.46" D; 241.5-298.6mm H x 374.0mm W x 66.3-189.6mm D Power supply 18 watts typical, 28 watts maximum, <2 watts standby/suspend, universal, integrated (no external brick-like power supply) Weight 5.82 lb; 2.64kg Limited warranty⁴ 3 year (includes backlight) Available date October 2008</p>	<p style="text-align: center;">Features</p> <ul style="list-style-type: none"> • Widescreen 15.6-inch monitor • EPEAT™ Gold rating • Supports WXGA 1366x768 resolution • Matching design to Lenovo notebooks and desktops 								
<p>VESA-compliant² VESA DDC2B/CI, VESA DPMS-compliant Power management ENERGY STAR[®] 4.1 Tier 2 Ergonomics ISO 13406 Part 2¹ Pixel defect ISO 13406-2 Class II pixel defect standard Emission standards MPR-2, MPR-3A, FCC Class B Environmental TCO 03, WEEE, RoHS (EU Directive 2002/95/EC), EPEAT™ Gold rating, GREENGUARD[®] certified</p>	<div style="text-align: center;">  <p>D156 Wide Monitor</p> </div>								
<p>Preset display resolutions VGA: 640x480, 640x350, 700x570 SVGA: 800x600 XGA: 1024x768 WXGA: 1360x768, 1366x768 Presets / user settings Standard presets: 13; user settings: 10</p>									
<p>Viewing adjustments Tilt: 20° back, 5° forward; no lift; no swivel; detachable stand Rotating screen None On screen display On screen display with digital user controls (7 languages) Control features Direct access (buttons on front) for automatic image setup and brightness USB hub None Multiple input None Monitor connector VGA 15-pin D-shell, analog, blue Signal cable Detachable, VGA 15-pin D-shell at each end, analog, 1.8 meter Mounting features Wall or desk mounting using the Radial Arm⁹ or third-party accessories meeting the VESA FPMPI[®] (75mm mount) Security Security keyhole for attachment of optional cable lock (Kensington[®] lock-compatible)</p>									
<p>Ship group Monitor, attached stand, Setup poster, Safety and Warranty Information, CD with multilingual User's Guide and monitor installation files, 1.8m analog signal cable, 1.8m black power cord</p>									
<p style="text-align: center;">Limited Warranty</p> <ul style="list-style-type: none"> ↪ 3 year limited warranty⁴ ↪ International Warranty Service⁵ ↪ Rapid Replacement Service at 1-800-IBM-SERV (426-7378) ↪ Replacement normally arrives in two business days, excluding holidays ↪ Lenovo pays all shipping costs for valid warranty claims⁶ ↪ Service upgrade options⁷ <ul style="list-style-type: none"> • 3 year, on site exchange, Mon-Fri 9-5 with next day response (ThinkPlus™ part number 41C9209) • 3 year, on site exchange, 7 day x 24 hr with 4 hour response (41C9212) • 4 year, on site exchange, Mon-Fri 9-5 with next day response (41C9227) • 4 year, on site exchange, 7 day x 24 hr with 4 hour response (41C9228) ↪ 24x7⁸ day toll-free support for warranty issues during the warranty period⁴ 	<p style="text-align: center;">Accessories</p> <table border="0"> <tr> <td>Kensington[®] Cable Lock from Lenovo</td> <td style="text-align: right;">73P2582</td> </tr> <tr> <td>Kensington Twin Head Cable Lock</td> <td style="text-align: right;">45K1620</td> </tr> <tr> <td>ThinkPad Convertible Monitor Stand</td> <td style="text-align: right;">40Y7620</td> </tr> <tr> <td>ThinkVision TFT Radial Arm⁹</td> <td style="text-align: right;">19K4464</td> </tr> </table> <p>See details at www.lenovo.com/support/monitoraccessories</p> <p>See all monitors at www.lenovo.com/thinkvision</p>	Kensington [®] Cable Lock from Lenovo	73P2582	Kensington Twin Head Cable Lock	45K1620	ThinkPad Convertible Monitor Stand	40Y7620	ThinkVision TFT Radial Arm ⁹	19K4464
Kensington [®] Cable Lock from Lenovo	73P2582								
Kensington Twin Head Cable Lock	45K1620								
ThinkPad Convertible Monitor Stand	40Y7620								
ThinkVision TFT Radial Arm ⁹	19K4464								

See footnotes for important warranty information
 US model announced September 17, 2008

Flat Panel Monitors - US model		Features
Name	L151 Flat Panel Monitor	<ul style="list-style-type: none"> • All-purpose 15-inch flat panel LCD monitor • EPEAT™ Gold rating • Slim 16mm (0.63") side bezel • Resolution of 1024x768 provides crisp screen images • Stand tilts for comfortable viewing • Direct access for automatic image setup and brightness • Quick and easy monitor adjustments using on-screen display menus • A great replacement for a 15" or 17" CRT monitor • Integrated power supply eliminates the bulky power adapter for improved cable management • Lockable digital controls • Matching design to ThinkPad® and ThinkCentre® systems
Case color	Business black	
Type-model	9165-AC6	
US Govt model (TAA) ¹⁰	No	
Stand	Tilt stand	
Screen	LCD Active Matrix TFT (Thin Film Transistor)	
Viewable image size(diag)	15.0" / 381mm (diagonal)	
Aspect ratio	4:3	
Pixel pitch (mm)	.297mm	
Max view area (inches)	12.0" x 9.0" (horizontal x vertical)	
Max view area (mm)	304mm x 228mm (horizontal x vertical)	
Viewing angle at 5:1 CR	140° (+80°/- 60°) vertical, 160° (+/- 80°) horizontal	
Viewing angle at 10:1 CR	125° (+/- 62.5°) vertical, 140° (+/- 70°) horizontal	
Video input	Analog	
Dual input	No	
Rotating screen	No pivot	
Optimum resolution	1024x768 at 60Hz	
Maximum resolution	1024x768 at 75Hz (80MHz maximum pixel rate)	
Vertical frequency	55 to 75Hz	
Horizontal frequency	30 to 63kHz	
Preset display modes	VGA: 640x480 60, 66, 72, 75Hz 640x350 70Hz 720x400 70Hz SVGA: 800x600 60, 72, 75Hz XGA: 1024x768 60, 70, 75Hz	
Presets / user settings	Standard presets: 12; user settings: 10	
Brightness	250 nits or cd/m ² (typical)	
Contrast ratio	500:1 (typical)	
Pixel response time	8ms (typical)	
Scaling	Can expand image of lower resolution to full screen of 1024x768	
On screen display	On screen display with digital user controls (7 languages)	
Control features	Direct access (buttons on front) for auto adjustment and brightness; contrast; image horizontal and vertical position; user color settings (3 preset + 1 user); on screen display (OSD) language selection; menu position; information screen; image setup; image size to show normal or expanded format; reset of geometry and color point to factory default settings; lockable settings	
Monitor connector	One connector: analog VGA 15-pin D-shell [blue]	
Signal cable	Analog cable, detachable, VGA 15-pin D-shell at each end (for analog connector), 1.8 meter, matches color of monitor	
Anti-reflective	Anti-reflective, anti-glare	
Dimensions	13.31"H x 13.56"W x 6.12"D / 338mm height x 345mm width x 156mm depth	
Weight	6.8 lb / 3.1kg	
Viewing adjustments	Tilt: 30° back, 4° forward, no swivel, no lift, detachable stand	
Mounting features	Wall or desk mounting using the Radial Arm ⁹ or third-party accessories meeting the VESA FPMPI [®] (100mm mount)	
Security	Security keyhole for attachment of optional cable lock (Kensington [®] lock-compatible)	
VESA-compliant ²	VESA DDC2B/C1, VESA DPMS-compliant	
Power management	ENERGY STAR ^{®3} 4.0	
Ergonomics	ISO 13406 Part 2 ¹	
Pixel defect	ISO 13406-2 Class II pixel defect standard	
Emission standards	MPR-2, MPR-3A, FCC Class B	
Environmental	TCO 99, WEEE, RoHS (EU Directive 2002/95/EC), EPEAT™ Gold rating	
Ship group	Monitor; attached stand; Setup Guide; Safety and Warranty Information; CD with multilingual User's Guide, set-up test pattern, and monitor installation files; analog signal cable; 1.8m black power cord	
Power supply	100-240Vac (universal), integrated (no external brick-like power supply), 25 watts typical, <2 watts standby/suspend	
Limited warranty ⁴	3-year (includes backlight)	
Available date	November 2007	

Limited Warranty	Accessories										
<ul style="list-style-type: none"> ⇒ 3-year limited warranty⁴ ⇒ International Warranty Service⁵ ⇒ Rapid Replacement Service at 1-800-IBM-SERV (426-7378) ⇒ Replacement normally arrives in two business days, excluding holidays ⇒ Lenovo pays all shipping costs for valid warranty claims⁵ ⇒ Service upgrade options:⁷ <ul style="list-style-type: none"> • 3 year, on site exchange, Mon-Fri 9-5 with next day response (ThinkPlus™ part number 41C9209) • 3 year, on site exchange, 7 day x 24 hr with 4 hour response (41C9212) • 4 year, on site exchange, Mon-Fri 9-5 with next day response (41C9233) • 4 year, on site exchange, 7 day x 24 hr with 4 hour response (41C9234) ⇒ 24x7⁸ day toll-free support for warranty issues during the warranty period⁴ 	<table> <tr> <td>ThinkVision® USB Soundbar</td> <td>40Y7616</td> </tr> <tr> <td>Kensington® MicroSaver® Security Cable Lock</td> <td>73P2582</td> </tr> <tr> <td>Kensington Twin Head Cable Lock</td> <td>45K1620</td> </tr> <tr> <td>ThinkPad Convertible Monitor Stand</td> <td>40Y7620</td> </tr> <tr> <td>ThinkVision TFT Radial Arm⁹</td> <td>19K4464</td> </tr> </table> <p>See details at www.lenovo.com/support/monitoraccessories</p> <p>See all monitors at www.lenovo.com/thinkvision</p>	ThinkVision® USB Soundbar	40Y7616	Kensington® MicroSaver® Security Cable Lock	73P2582	Kensington Twin Head Cable Lock	45K1620	ThinkPad Convertible Monitor Stand	40Y7620	ThinkVision TFT Radial Arm ⁹	19K4464
ThinkVision® USB Soundbar	40Y7616										
Kensington® MicroSaver® Security Cable Lock	73P2582										
Kensington Twin Head Cable Lock	45K1620										
ThinkPad Convertible Monitor Stand	40Y7620										
ThinkVision TFT Radial Arm ⁹	19K4464										

See footnotes for important warranty information
US model announced October 23, 2006

Flat Panel Monitors - US model		Features										
Name	L171 Flat Panel Monitor	<ul style="list-style-type: none"> • All-purpose 17-inch flat panel LCD monitor • EPEAT™ Gold rating • Slim 14mm (0.55") side bezel • Resolution of 1280x1024 provides crisp screen images • Stand tilts for comfortable viewing • Direct access for automatic image setup and brightness • Quick and easy monitor adjustments using on-screen-display • A great replacement for a 17" or 19" CRT monitor • Scaling allows full screen viewing of resolutions less than 1280x1024 • Integrated power supply eliminates the bulky power adapter for improved cable management • Lockable digital controls • Matching design to ThinkPad® and ThinkCentre® systems 										
Case color	Business black											
Type-model	9227-AD1											
US Govt model (TAA) ¹⁰	No											
Stand	Tilt stand											
Screen	LCD Active Matrix TFT (Thin Film Transistor)											
Viewable image size (diag)	17.0" / 432mm (diagonal)											
Aspect ratio	5:4											
Pixel pitch (mm)	.264mm											
Max view area (inches)	13.3" x 10.6" (horizontal x vertical)											
Max view area (mm)	340mm x 272mm (horizontal x vertical)											
Viewing angle at 10:1 CR	130° (+67°/- 63°) vertical, 140° (+/- 70°) horizontal											
Video input	Analog											
Dual input	No											
Optimum resolution	1280x1024 at 60Hz											
Maximum resolution	1280x1024 at 76Hz (140MHz maximum pixel rate)											
Vertical frequency	55 to 75Hz											
Horizontal frequency	30 to 83kHz											
Preset display modes	VGA: 640x480 60, 72, 75Hz 640x350 70Hz 720x400 70Hz SVGA: 800x600 60, 72, 75Hz XGA: 1024x768 60, 70, 75 Hz SXGA: 1280x1024 60, 70, 75, 76 (Sun) Hz											
Presets / user settings	Standard presets: 15; user settings: 20											
Brightness	300 nits or cd/m ² (typical)											
Contrast ratio	700:1 (typical)											
Pixel response time	5ms (typical)											
Scaling	Can expand image of lower resolution to full screen of 1280x1024											
On screen display	On screen display with digital user controls (7 languages)											
Control features	Direct access (buttons on front) for auto adjustment and brightness; contrast; image horizontal and vertical position; user color settings (3 preset + 1 user); on screen display (OSD) language selection; menu position; information screen; image setup; image size to show normal or expanded format; reset of geometry and color point to factory default settings; lockable settings											
Monitor connector	One connector: analog VGA 15-pin D-shell [blue]											
Signal cable	Analog cable, detachable, VGA 15-pin D-shell at each end (for analog connector), 1.8 meter, matches color of monitor											
Anti-reflective	Anti-reflective, anti-glare											
Dimensions	15.2"H x 14.6"W x 6.8"D / 387mm height x 371mm width x 173mm depth											
Weight	9.1 lb / 4.2kg											
Viewing adjustments	Tilt: 30° back, 4° forward, no swivel, no lift, detachable stand											
Mounting features	Wall or desk mounting using the TFT Radial Arm ⁹ or third-party accessories meeting the VESA FPMPI [®] (100mm mount)											
Security	Security keyhole for attachment of optional cable lock (Kensington [®] lock-compatible)											
VESA-compliant ²	VESA DDC2B/CI, VESA DPMS-compliant											
Power management	ENERGY STAR ^{®3} 4.0											
Ergonomics	ISO 13406 Part 2 ¹											
Pixel defect	ISO 13406-2 Class II pixel defect standard											
Emission standards	MPR-2, MPR-3A, FCC Class B											
Environmental	TCO 99, WEEE, RoHS (EU Directive 2002/95/EC), EPEAT™ Gold rating											
Ship group	Monitor, attached stand, customer installable base, Setup Guide, Safety and Warranty Information, CD with multilingual User's Guide and monitor installation files, analog signal cable, 1.8m black power cord											
Power supply	100-240Vac (universal), integrated (no external brick-like power supply), 28 watts typical, <2 watts standby/suspend											
Limited warranty ⁴	3 year (includes backlight)											
Available date	November 2007											
<p align="center">Limited Warranty</p> <ul style="list-style-type: none"> ↪ 3-year limited warranty⁴ ↪ International Warranty Service⁵ ↪ Rapid Replacement Service at 1-800-IBM-SERV (426-7378) ↪ Replacement normally arrives in two business days, excluding holidays ↪ Lenovo pays all shipping costs for valid warranty claims⁵ ↪ Service upgrade options:⁷ <ul style="list-style-type: none"> • 3 year, on site exchange, Mon-Fri 9-5 with next day response (ThinkPlus™ part number 41C9209) • 3 year, on site exchange, 7 day x 24 hr with 4 hour response (41C9212) • 4 year, on site exchange, Mon-Fri 9-5 with next day response (41C9233) • 4 year, on site exchange, 7 day x 24 hr with 4 hour response (41C9234) ↪ 24x7⁸ day toll-free support for warranty issues during the warranty period⁴ 		<p align="center">Accessories</p> <table border="0"> <tr> <td>ThinkVision® USB Soundbar</td> <td>40Y7616</td> </tr> <tr> <td>Kensington® MicroSaver® Security Cable Lock</td> <td>73P2582</td> </tr> <tr> <td>Kensington Twin Head Cable Lock</td> <td>45K1620</td> </tr> <tr> <td>ThinkPad Convertible Monitor Stand</td> <td>40Y7620</td> </tr> <tr> <td>ThinkVision TFT Radial Arm⁹</td> <td>19K4464</td> </tr> </table> <p>See details at www.lenovo.com/support/monitoraccessories</p> <p>See all monitors at www.lenovo.com/thinkvision</p>	ThinkVision® USB Soundbar	40Y7616	Kensington® MicroSaver® Security Cable Lock	73P2582	Kensington Twin Head Cable Lock	45K1620	ThinkPad Convertible Monitor Stand	40Y7620	ThinkVision TFT Radial Arm ⁹	19K4464
ThinkVision® USB Soundbar	40Y7616											
Kensington® MicroSaver® Security Cable Lock	73P2582											
Kensington Twin Head Cable Lock	45K1620											
ThinkPad Convertible Monitor Stand	40Y7620											
ThinkVision TFT Radial Arm ⁹	19K4464											

See footnotes for important warranty information
US model announced October 23, 2006

Flat Panel Monitors - US model		Positioning										
Name	L171p Flat Panel Monitor	<ul style="list-style-type: none"> Performance—Advanced flat panel design features provides space savings and performance. TFT performance models offer tilt, swivel, pivot, and height adjustments, plus analog and digital system attachments. 										
Case color	Business black											
Type-model	9417-HC2	<p>Description</p> <ul style="list-style-type: none"> The L171p is a hybrid monitor. It has both an analog (15-pin D-shell) and digital (Digital Visual Interface [DVI-D]) connector on the back of the monitor. This allows one monitor to connect to different types of graphics adapters; this can be from one analog input and one digital input (it can not accept two analog inputs). 										
Stand	Tilt, swivel, pivot, height adjustable stand											
Screen	LCD Active Matrix TFT (Thin Film Transistor)	<p>Features</p> <ul style="list-style-type: none"> General purpose 17-inch flat panel LCD monitor incorporates ThinkVantage Design that enhances usability and complements the system design EPEAT™ Gold rating Slim 14mm (0.55") side bezel Resolution of 1280x1024 provides crisp screen images Ergonomic stand tilts, swivels, pivots and provides a 110mm range height adjustment for comfortable viewing Direct access for automatic image setup, brightness and input selection Quick and easy monitor adjustments on-screen-display A great replacement for a 17" or 19" CRT monitor Includes dual input connection for attachment to two systems concurrently (analog and digital) Integrated power supply eliminates the bulky power adapter for improved cable management Matching design to ThinkPad® and ThinkCentre® systems 										
Viewable image size (diag)	17.0" / 432mm (diagonal)											
Pixel pitch (mm)	.264mm											
Max view area (inches)	13.4" x 10.7" (horizontal x vertical)											
Max view area (mm)	340mm x 272mm (horizontal x vertical)											
Viewing angle at 10:1 CR	130° (+70°/- 60°) vertical, 140° (+/- 70°) horiz											
Video input	Digital or analog (two separate connectors)											
Dual input	Dual input (two different PCs attach to two different connectors; one PC shows image; select via button)											
Sync on green	Yes											
Rotating screen	Screen pivots 90 degrees from landscape to portrait (requires image rotation support from graphics controller)											
Optimum resolution	1280x1024 at 60Hz											
Maximum resolution	1280x1024 at 76Hz (135MHz maximum pixel rate)											
Vertical frequency	55 to 76Hz											
Horizontal frequency	31 to 81kHz											
Display colors (maximum)	More than 16 million simultaneous colors											
Preset display modes	VGA: 640x480 60, 66, 72, 75Hz 640x350 70Hz 720x400 70Hz SVGA: 800x600 60, 72, 75Hz XGA: 1024x768 60, 70, 75Hz SXGA: 1280x1024 60, 70, 72, 75, 76 Hz											
Presets / user settings	Standard presets: 17; user settings: 20											
Brightness	300 nits or cd/m ² (typical)											
Contrast ratio	500:1 (typical)											
Pixel response time	8ms (typical)											
On screen display	On screen display with digital user controls (6 languages)											
Control features	Direct access (buttons on front) for auto adjustment, brightness, and input select; contrast; image horizontal and vertical position; user color settings (3 preset + 1 user); on screen display (OSD) language selection; menu position; information screen; image setup; image size to show normal or expanded format; reset of geometry and color point to factory default settings; lockable settings											
Monitor connectors	Two connectors: (1) analog VGA 15-pin D-shell [blue], (2) Digital Visual Interface (DVI-D) for digital (not analog) attach [white]											
Signal cable	Two cables: (1) detachable, VGA 15-pin D-shell at each end (for analog connector), 1.8 meter, matches color of monitor (2) detachable digital, DVI-D at each end (for digital connector), 2.0 meter, matches color of monitor											
Anti-reflective / anti-glare	Anti-reflective / anti-glare											
Dimensions	15.1"H min lift (19.4" max lift) x 14.6"W x 8.3"D / 383mm min lift (493mm max lift) height x 371mm width x 211mm depth											
Weight	11.9 lb / 5.4 kg											
Viewing adjustments	Tilt: 30° back, 0° forward / lift: 4.3" (110mm) / swivel: +/-45° / detachable stand											
Mounting features	Wall or desk mounting using the Radial Arm ⁹ or third-party accessories meeting the VESA FPMPI [®] (100mm mount)											
Security	Security keyhole for attachment of optional cable lock (Kensington [®] lock-compatible)											
VESA-compliant ²	VESA DDC2B/CI and VESA DPMS-compliant											
Power management	ENERGY STAR ^{®3} 4.0											
Ergonomics	ISO 13406 Part 2 ¹											
Pixel defect	ISO 13406-2 Class II pixel defect standard											
Emission standards	MPR-2 / MPR-3A / FCC Class B											
Environmental	TCO 99, EPEAT™ Gold rating											
RoHS	RoHS (EU Directive 2002/95/EC)											
Ship group	Monitor, attached stand, Setup Guide, Safety and Warranty Information, CD with multilingual User's Guide and monitor installation files, analog signal cable, digital signal cable, 1.8m black power cord											
Power supply	100-240Vac (universal) / integrated (no external brick-like power supply) / 40 watts typical (3 watts for "active off")											
Limited warranty ⁴	3 year (includes backlight)											
Available date	November 2006											
<p>Limited Warranty</p> <ul style="list-style-type: none"> ↪ 3 year limited warranty⁴ ↪ International Warranty Service⁵ ↪ Rapid Replacement Service at 1-800-IBM-SERV (426-7378) ↪ Replacement normally arrives in two business days, excluding holidays ↪ Lenovo pays all shipping costs for valid warranty claims⁶ ↪ Service upgrade options⁷ <ul style="list-style-type: none"> • 3 year, on site exchange, Mon-Fri 9-5 with next day response (ThinkPlus™ part number 41C9209) • 3 year, on site exchange, 7 day x 24 hr with 4 hour response (ThinkPlus part number 41C9212) • 4 year, on site exchange, Mon-Fri 9-5 with next day response (ThinkPlus part number 41C9231) • 4 year, on site exchange, 7 day x 24 hr with 4 hour response (ThinkPlus part number 41C9232) ↪ 24x7⁸ day toll-free support for warranty issues during the warranty period⁴ 		<p>Accessories</p> <table border="0"> <tr> <td>ThinkVision® USB Soundbar</td> <td>40Y7616</td> </tr> <tr> <td>Kensington® MicroSaver® Security Cable Lock</td> <td>73P2582</td> </tr> <tr> <td>Kensington Twin Head Cable Lock</td> <td>45K1620</td> </tr> <tr> <td>ThinkPad Convertible Monitor Stand</td> <td>40Y7620</td> </tr> <tr> <td>ThinkVision TFT Radial Arm⁹</td> <td>19K4464</td> </tr> </table> <p>See details at www.lenovo.com/support/monitoraccessories</p> <p>See all monitors at www.lenovo.com/thinkvision</p>	ThinkVision® USB Soundbar	40Y7616	Kensington® MicroSaver® Security Cable Lock	73P2582	Kensington Twin Head Cable Lock	45K1620	ThinkPad Convertible Monitor Stand	40Y7620	ThinkVision TFT Radial Arm ⁹	19K4464
ThinkVision® USB Soundbar	40Y7616											
Kensington® MicroSaver® Security Cable Lock	73P2582											
Kensington Twin Head Cable Lock	45K1620											
ThinkPad Convertible Monitor Stand	40Y7620											
ThinkVision TFT Radial Arm ⁹	19K4464											

See footnotes for important warranty information
US model announced October 31, 2006

Flat Panel Monitors - US model		Features										
Name	L174 Flat Panel Monitor	<ul style="list-style-type: none"> • All-purpose 17-inch flat panel LCD monitor • EPEAT™ Gold rating • Resolution of 1280x1024 provides crisp screen images • Slim 15.6mm (0.61") side bezel • Stand tilts for comfortable viewing • Direct access for automatic image setup and brightness • Quick and easy monitor adjustments using on-screen-display • Scaling allows full screen viewing of resolutions less than 1280x1024 • Integrated power supply eliminates the bulky power adapter for improved cable management • Lockable digital controls • Complements the ThinkCentre® and ThinkPad® systems 										
Case color	Business black											
Type-model	9227-AE1											
Stand	Tilt stand											
Screen	LCD Active Matrix TFT (Thin Film Transistor)											
Viewable image size (diag)	17.0" / 432mm (diagonal)											
Aspect ratio	5:4											
Pixel pitch (mm)	.264mm											
Max view area (inches)	13.3" x 10.6" (horizontal x vertical)											
Max view area (mm)	340mm x 272mm (horizontal x vertical)											
Viewing angle at 5:1 CR	140° vertical, 152° horizontal											
Viewing angle at 10:1 CR	130° vertical, 140° horizontal											
Video input	Analog											
Dual input	No											
Optimum resolution	1280x1024 at 60Hz	 <p>Lenovo ThinkVision L174</p>										
Maximum resolution	1280x1024 at 76Hz (140MHz maximum pixel rate)											
Vertical frequency	55 to 75Hz											
Horizontal frequency	30 to 83kHz											
Preset display modes	VGA: 640x480 60, 66, 72, 75Hz 640x350 70Hz 720x400 70Hz SVGA: 800x600 60, 72, 75Hz XGA: 1024x768 60, 70, 75Hz SXGA: 1280x1024 60, 70, 75, 76Hz											
Presets / user settings	Standard presets: 16; user settings: 20											
Brightness	250 nits or cd/m ² (typical)											
Contrast ratio	700:1 (typical)											
Pixel response time	5ms (typical)											
Color gamut	72%											
Scaling	Can expand image of lower resolution to full screen of 1280x1024											
On screen display	On screen display with digital user controls (7 languages)											
Control features	Direct access (buttons on front) for auto adjustment and brightness; contrast; image horizontal and vertical position; user color settings (3 preset + 1 user); on screen display (OSD) language selection; menu position; information screen; image setup; image size to show normal or expanded format; reset of geometry and color point to factory default settings; lockable settings											
Monitor connector	One connector: analog VGA 15-pin D-shell [blue]											
Signal cable	Analog cable, detachable, VGA 15-pin D-shell at each end (for analog connector), 1.8 meter, matches color of monitor											
Anti-reflective	Anti-reflective, anti-glare											
Dimensions	15.3"H x 14.6"W x 6.8"D / 387mm height x 371mm width x 173mm depth											
Weight	9.1 lb / 4.2kg											
Viewing adjustments	Tilt: 30° back, 4° forward, no swivel, no lift, detachable stand											
Mounting features	Wall or desk mounting using the TFT Radial Arm ⁹ or third-party accessories meeting the VESA FPMPI [®] (100mm mount)											
Security	Security keyhole for attachment of optional cable lock (Kensington [®] lock-compatible)											
VESA-compliant ²	VESA DDC2B/C1, VESA DPMS-compliant											
Power management	ENERGY STAR [®] 4.1 Tier 2											
Ergonomics	ISO 13406 Part 2 ¹											
Pixel defect	ISO 13406-2 Class II pixel defect standard											
Emission standards	MPR-2, MPR-3A, FCC Class B											
Environmental	TCO 03, WEEE, RoHS (EU Directive 2002/95/EC), EPEAT™ Gold rating											
Ship group	Monitor, attached stand, customer installable base, Setup Guide, Safety and Warranty Information, CD with multilingual User's Guide and monitor installation files, analog signal cable, 1.8m black power cord											
Power supply	100-240Vac (universal), integrated (no external brick-like power supply), 20 watts typical, <2 watts standby/suspend											
Limited warranty ⁴	3 year (includes backlight)											
Available date	April 2008											
<p align="center">Limited Warranty</p> <ul style="list-style-type: none"> ↪ 3-year limited warranty⁴ ↪ International Warranty Service⁵ ↪ Rapid Replacement Service at 1-800-IBM-SERV (426-7378) ↪ Replacement normally arrives in two business days, excluding holidays ↪ Lenovo pays all shipping costs for valid warranty claims⁶ ↪ Service upgrade options:⁷ <ul style="list-style-type: none"> • 3 year, on site exchange, Mon-Fri 9-5 with next day response (ThinkPlus™ part number 41C9209) • 3 year, on site exchange, 7 day x 24 hr with 4 hour response (41C9212) • 4 year, on site exchange, Mon-Fri 9-5 with next day response (41C9233) • 4 year, on site exchange, 7 day x 24 hr with 4 hour response (41C9234) ↪ 24x7⁸ day toll-free support for warranty issues during the warranty period⁴ 		<p align="center">Accessories</p> <table border="0"> <tr> <td>ThinkVision® USB Soundbar</td> <td>40Y7616</td> </tr> <tr> <td>Kensington® MicroSaver® Security Cable Lock</td> <td>73P2582</td> </tr> <tr> <td>Kensington Twin Head Cable Lock</td> <td>45K1620</td> </tr> <tr> <td>ThinkPad Convertible Monitor Stand</td> <td>40Y7620</td> </tr> <tr> <td>ThinkVision TFT Radial Arm⁹</td> <td>19K4464</td> </tr> </table> <p>See details at www.lenovo.com/support/monitoraccessories</p> <p>See all monitors at www.lenovo.com/thinkvision</p>	ThinkVision® USB Soundbar	40Y7616	Kensington® MicroSaver® Security Cable Lock	73P2582	Kensington Twin Head Cable Lock	45K1620	ThinkPad Convertible Monitor Stand	40Y7620	ThinkVision TFT Radial Arm ⁹	19K4464
ThinkVision® USB Soundbar	40Y7616											
Kensington® MicroSaver® Security Cable Lock	73P2582											
Kensington Twin Head Cable Lock	45K1620											
ThinkPad Convertible Monitor Stand	40Y7620											
ThinkVision TFT Radial Arm ⁹	19K4464											

See footnotes for important warranty information
US model announced April 15, 2006

<p>Name L1700p Flat Panel Monitor Case color Business black Type-model 9417-HE2 Panel TFT-LCD, twisted nematic (TN), CCFL backlight Viewable image size 17.0" (432mm) diagonal Max view area (W x H) 13.3" x 10.6" (337.9mm x 270.3mm) Optimum resolution 1280x1024 at 60Hz Maximum resolution 1280x1024 at 75Hz (135MHz max pixel rate) Aspect ratio 5:4 Pixel pitch (mm) 0.264mm Dot/Pixel per Inch 96 dpi Brightness 250 nits or cd/m² (typical) Contrast ratio 800:1 (typical) Pixel response time 5ms (typical) Color gamut 72% Anti-reflective Anti-reflective, anti-glare Vertical frequency 55 to 76Hz Horizontal frequency 30 to 81kHz Viewing angle at 10:1 CR 160° (+/- 80°) horizontal, 160° (+/- 80°) vertical Stand Tilt, swivel, pivot, and height adjustable stand Bezel width Sides: 0.63" (16.1mm); top: 0.73" (18.6mm); bottom: 1.07" (27.2mm) Dimensions (HxWxD) 14.4-18.7" H x 14.6" W x 6.7-7.8" D; 366.1-476.1mm H x 371.3mm W x 170.2-223.3mm D Power supply 16 watts typical, 21 watts maximum, <1 watts standby/suspend, universal, integrated (no external brick-like power supply) Weight 10.5 lb; 4.8kg Limited warranty⁴ 3 year (includes backlight) Available date September 2008</p>	<p>Features</p> <ul style="list-style-type: none"> • Regular screen 17-inch monitor • Supports SXGA 1280x1024 resolution • Ergonomic stand tilts, swivels, pivots and provides a 4.3" (110mm) range height adjustment for comfortable viewing • Detachable rear stand cable cover and clip to hide cables • Carrying handle • Microsoft® Windows® Vista® certified 										
<p>VESA-compliant² VESA DDC2B/CI, VESA DPMS-compliant Power management ENERGY STAR[®] 4.1 Tier 2 Ergonomics ISO 13406 Part 2¹ Pixel defect ISO 13406-2 Class II pixel defect standard Emission standards MPR-2, MPR-3A, FCC Class B Environmental TCO 03, WEEE, RoHS (EU Directive 2002/95/EC), EPEAT™ Gold rating, GREENGUARD® certified</p>	 <p style="text-align: center;">ThinkVision L1700p Monitor</p>										
<p>Preset resolutions VGA: 640x350, 640x480, 720x400 SVGA: 800x600, 832x624 XGA: 1024x768, 1152x864 WXGA: 1280x720, 1280x768 SXGA: 1280x1024 Presets / user settings Standard presets: 21; user settings: 20</p>											
<p>Viewing adjustments Tilt: 30° back, 0° forward; lift: 4.3" (110mm); swivel: +/-45°; detachable stand Rotating screen Screen pivots 90 degrees from landscape to portrait (requires image rotation support from graphics controller), On screen display On screen display with digital user controls (8 languages) Control features Direct access (buttons on front) for automatic image setup Multiple input Multiple input (two different PCs attach to two different connectors; one PC shows image; select via button) Monitor connectors (1) VGA 15-pin D-shell, analog, blue (2) Digital Visual Interface (DVI-D), digital, white, HDCP-compliant Signal cables (1) detachable, VGA 15-pin D-shell at each end, analog, 1.8 meter (2) detachable, DVI-D at each end, digital, 1.8 meter Mounting features Wall or desk mounting using the Radial Arm⁹ or third-party accessories meeting the VESA FPMPI[®] (100mm mount) Security Security keyhole for attachment of optional cable lock (Kensington[®] lock-compatible)</p>	<p>Accessories</p> <table border="0"> <tr> <td>ThinkVision USB Soundbar</td> <td>40Y7616</td> </tr> <tr> <td>Kensington[®] Cable Lock from Lenovo</td> <td>73P2582</td> </tr> <tr> <td>Kensington Twin Head Cable Lock</td> <td>45K1620</td> </tr> <tr> <td>ThinkPad Convertible Monitor Stand</td> <td>40Y7620</td> </tr> <tr> <td>ThinkVision TFT Radial Arm⁹</td> <td>19K4464</td> </tr> </table> <p>See details at www.lenovo.com/support/monitoraccessories</p> <p>See all monitors at www.lenovo.com/thinkvision</p>	ThinkVision USB Soundbar	40Y7616	Kensington [®] Cable Lock from Lenovo	73P2582	Kensington Twin Head Cable Lock	45K1620	ThinkPad Convertible Monitor Stand	40Y7620	ThinkVision TFT Radial Arm ⁹	19K4464
ThinkVision USB Soundbar	40Y7616										
Kensington [®] Cable Lock from Lenovo	73P2582										
Kensington Twin Head Cable Lock	45K1620										
ThinkPad Convertible Monitor Stand	40Y7620										
ThinkVision TFT Radial Arm ⁹	19K4464										
<p>Limited Warranty</p> <ul style="list-style-type: none"> ↪ 3 year limited warranty⁴ ↪ International Warranty Service⁵ ↪ Rapid Replacement Service at 1-800-IBM-SERV (426-7378) ↪ Replacement normally arrives in two business days, excluding holidays ↪ Lenovo pays all shipping costs for valid warranty claims⁶ ↪ Service upgrade options:⁷ <ul style="list-style-type: none"> • 3 year, on site exchange, Mon-Fri 9-5 with next day response (ThinkPlus™ part number 41C9209) • 3 year, on site exchange, 7 day x 24 hr with 4 hour response (41C9212) • 4 year, on site exchange, Mon-Fri 9-5 with next day response (41C9233) • 4 year, on site exchange, 7 day x 24 hr with 4 hour response (41C9234) ↪ 24x7⁸ day toll-free support for warranty issues during the warranty period⁴ 	<p>Accessories</p> <table border="0"> <tr> <td>ThinkVision USB Soundbar</td> <td>40Y7616</td> </tr> <tr> <td>Kensington[®] Cable Lock from Lenovo</td> <td>73P2582</td> </tr> <tr> <td>Kensington Twin Head Cable Lock</td> <td>45K1620</td> </tr> <tr> <td>ThinkPad Convertible Monitor Stand</td> <td>40Y7620</td> </tr> <tr> <td>ThinkVision TFT Radial Arm⁹</td> <td>19K4464</td> </tr> </table> <p>See details at www.lenovo.com/support/monitoraccessories</p> <p>See all monitors at www.lenovo.com/thinkvision</p>	ThinkVision USB Soundbar	40Y7616	Kensington [®] Cable Lock from Lenovo	73P2582	Kensington Twin Head Cable Lock	45K1620	ThinkPad Convertible Monitor Stand	40Y7620	ThinkVision TFT Radial Arm ⁹	19K4464
ThinkVision USB Soundbar	40Y7616										
Kensington [®] Cable Lock from Lenovo	73P2582										
Kensington Twin Head Cable Lock	45K1620										
ThinkPad Convertible Monitor Stand	40Y7620										
ThinkVision TFT Radial Arm ⁹	19K4464										

See footnotes for important warranty information
 US model announced September 17, 2008

Flat Panel Monitors - US model	Features
<p>Name L190x Flat Panel Monitor Case color Business black Type-model 4439-HB2 Stand Tilt, swivel, pivot, and height adjustable stand Screen LCD Active Matrix TFT (Thin Film Transistor) Viewable image size (diag) 19.0" / 482mm (diagonal) Aspect ratio 5:4 Pixel pitch (mm) .29mm Max view area (inches) 14.8" x 11.8" (horizontal x vertical) Max view area (mm) 376mm x 301mm (horizontal x vertical) Viewing angle at 10:1 CR 178° (+/- 89°) vertical, 178° (+/- 89°) horizontal Video input Digital or analog (two separate connectors) Dual input Dual input (two different PCs attach to two different connectors; one PC shows image; select via button) Rotating screen Screen pivots 90 degrees from landscape to portrait (requires image rotation support from graphics controller), auto-rotation without software USB hub USB 2.0 Hub (1 port into PC, 4 ports for accessories)</p>	<ul style="list-style-type: none"> • All-purpose 19-inch flat panel monitor • EPEAT™ Gold rating • Ultra slim 6.6mm (0.26") side bezel • Ideal for dual monitor solution with ultra slim bezels • High-bandwidth Digital Content Protection (HDCP)-compliant • USB hub (four powered ports) • Carrying handle • Ergonomic stand tilts, swivels, pivots and provides a 110mm range height adjustment for comfortable viewing • Quick and easy monitor adjustments with on-screen-display via OnScreen Manager™ (<i>softOSM™</i>) • Includes dual input connection for attachment to two systems concurrently (analog and digital) • Rear stand cover and clip to hide cables • Complements the ThinkCentre® and ThinkPad® systems • Microsoft® Windows® Vista™ Premium certified
<p>Optimum resolution 1280x1024 at 60Hz Maximum resolution 1280x1024 at 76Hz (135MHz maximum pixel rate) Vertical frequency 50 to 75Hz Horizontal frequency 30 to 80kHz Preset display modes VGA: 640x480 60, 66 (Mac), 72, 75Hz 640x350 70Hz 720x400 70Hz SVGA: 800x600 60, 72, 75Hz XGA: 1024x768 60, 70, 75Hz 1152x864 75Hz SXGA: 1280x1024 60, 72, 75Hz Standard presets: 16; user settings: 16 Presets / user settings Brightness 250 nits or cd/m² (typical) Contrast ratio 1500:1 (typical) Pixel response time 25ms (typical) Color gamut 72%</p>	 <p style="text-align: center;">Two Lenovo ThinkVision L190x monitors: ideal for dual monitor solution with 6.6mm ultra slim bezel</p>
<p>On screen display (1) On screen display with digital user controls (7 languages) (2) EnTech Taiwan OnScreen Manager™ (<i>softOSM™</i>) Control features Direct access (buttons on front) for automatic image setup Monitor connectors Two connectors: (1) analog VGA 15-pin D-shell [blue], (2) Digital Visual Interface (DVI-D) for digital (not analog) attach [white], HDCP-compliant Signal cables Two cables: (1) detachable, VGA 15-pin D-shell at each end (for analog connector), 3.0 meter, matches color of monitor (2) detachable digital, DVI-D at each end (for digital connector), 3.0 meter, matches color of monitor Anti-reflective Anti-reflective, anti-glare Dimensions 14.4"H min lift (20.0" max lift) x 15.5"W x 9.4"D / 366mm min lift (476mm max lift) height x 393mm width x 240mm depth Weight 13.2 lb / 6.0kg Viewing adjustments Tilt: 30° back, 0° forward / lift: 4.3" (110mm), swivel: +/-45°, detachable stand Mounting features Wall or desk mounting using the Radial Arm® or third-party accessories meeting the VESA FPMPI® (100mm mount) Security Security keyhole for attachment of optional cable lock (Kensington® lock-compatible)</p>	
<p>VESA-compliant² VESA DDC2B/C1, VESA DPMS-compliant Power management ENERGY STAR®³ 4.0 Ergonomics ISO 13406 Part 2¹ Pixel defect ISO 13406-2 Class II pixel defect standard Emission standards MPR-2, MPR-3A, FCC Class B Environmental TCO 03, WEEE, RoHS (EU Directive 2002/95/EC), EPEAT™ Gold rating Ship group Monitor, attached stand, Setup Guide, Safety and Warranty Information, CD with multilingual User's Guide and monitor installation files, analog signal cable, digital signal cable, 3 meter USB cable, 1.8m black power cord Power supply 90-264Vac (universal), integrated (no external brick-like power supply), 31 watts typical, <2 watts standby/suspend Limited warranty⁴ 3 year (includes backlight) Available date November 2007</p>	

Limited Warranty	Accessories
<ul style="list-style-type: none"> ↪ 3 year limited warranty⁴ ↪ International Warranty Service⁵ ↪ Rapid Replacement Service at 1-800-IBM-SERV (426-7378) ↪ Replacement normally arrives in two business days, excluding holidays ↪ Lenovo pays all shipping costs for valid warranty claims⁶ ↪ Service upgrade options:⁷ <ul style="list-style-type: none"> • 3 year, on site exchange, Mon-Fri 9-5 with next day response (ThinkPlus™ part number 41C9209) • 3 year, on site exchange, 7 day x 24 hr with 4 hour response (41C9212) • 4 year, on site exchange, Mon-Fri 9-5 with next day response (41C9233) • 4 year, on site exchange, 7 day x 24 hr with 4 hour response (41C9234) ↪ 24x7⁸ day toll-free support for warranty issues during the warranty period⁴ 	<p>ThinkVision® USB Soundbar 40Y7616 Kensington® MicroSaver® Security Cable Lock 73P2582 Kensington Twin Head Cable Lock 45K1620 ThinkPad Convertible Monitor Stand 40Y7620 ThinkVision TFT Radial Arm⁹ 19K4464</p> <p>See details at www.lenovo.com/support/monitoraccessories</p> <p>See all monitors at www.lenovo.com/thinkvision</p>

See footnotes for important warranty information
 US model announced October 23, 2007

Flat Panel Monitors - US model	Features
<p>Name L193p Flat Panel Monitor Case color Business black Type-model 4431-HB2 Stand Tilt, swivel, pivot, and height adjustable stand Screen LCD Active Matrix TFT (Thin Film Transistor) Viewable image size (diag) 19.0" / 483mm (diagonal) Aspect ratio 5:4 Pixel pitch (mm) .29mm Max view area (inches) 14.8" x 11.9" (horizontal x vertical) Max view area (mm) 376mm x 301mm (horizontal x vertical) Viewing angle at 10:1 CR 160° (+/- 80°) vertical, 160° (+/- 80°) horizontal Video input Digital or analog (two separate connectors) Dual input Dual input (two different PCs attach to two different connectors; one PC shows image; select via button)</p> <p>Rotating screen Screen pivots 90 degrees from landscape to portrait (requires image rotation support from graphics controller), auto-rotation without software</p> <p>USB hub None</p> <p>Optimum resolution 1280x1024 at 60Hz Maximum resolution 1280x1024 at 75Hz (135MHz maximum pixel rate) Vertical frequency 56 to 76Hz Horizontal frequency 30 to 81kHz Preset display modes VGA: 640x480 60, 66 (Mac), 72, 75Hz 640x350 70Hz 720x400 70Hz SVGA: 800x600 60, 72, 75Hz 832x624 75Hz (Mac) XGA: 1024x768 60, 70, 75 (Mac), 75Hz 1152x864 75Hz 1152x870 75Hz 1152x900 66Hz SXGA: 1280x1024 60, 72, 75, 76 (Sun) Hz</p> <p>Presets / user settings Standard presets: 21; user settings: 17 Brightness 300 nits or cd/m² (typical) Contrast ratio 800:1 (typical) Pixel response time 5ms (typical) Color gamut 72%</p> <p>On screen display (1) On screen display with digital user controls (7 languages) (2) EnTech Taiwan OnScreen Manager™ (soft OSM™)</p> <p>Control features Direct access (buttons on front) for automatic image setup</p> <p>Monitor connectors Two connectors: (1) analog VGA 15-pin D-shell [blue], (2) Digital Visual Interface (DVI-D) for digital (not analog) attach [white], HDCP-compliant</p> <p>Signal cables Two cables: (1) detachable, VGA 15-pin D-shell at each end (for analog connector), 3.0 meter, matches color of monitor (2) detachable digital, DVI-D at each end (for digital connector), 3.0 meter, matches color of monitor</p> <p>Anti-reflective Anti-reflective, anti-glare</p> <p>Dimensions 14.9"H min lift (19.2" max lift) x 16.1"W x 9.4"D / 379mm min lift (489mm max lift) height x 408mm width x 240mm depth</p> <p>Weight 13.0 lb / 6.0kg</p> <p>Viewing adjustments Tilt: 30° back, 0° forward / lift: 4.3" (110mm), swivel: +/-45°, detachable stand</p> <p>Mounting features Wall or desk mounting using the Radial Arm[®] or third-party accessories meeting the VESA FPMPI[®] (100mm mount)</p> <p>Security Security keyhole for attachment of optional cable lock (Kensington[®] lock-compatible)</p> <p>VESA-compliant² VESA DDC2B/C1, VESA DPMS-compliant</p> <p>Power management ENERGY STAR[®] 4.0</p> <p>Ergonomics ISO 13406 Part 2¹</p> <p>Pixel defect ISO 13406-2 Class II pixel defect standard</p> <p>Emission standards MPR-2, MPR-3A, FCC Class B</p> <p>Environmental TCO 03, WEEE, RoHS (EU Directive 2002/95/EC), EPEAT™ Gold rating</p> <p>Ship group Monitor, attached stand, Setup poster, Safety and Warranty Information, CD with multilingual User's Guide and monitor installation files, analog signal cable, digital signal cable, 1.8m black power cord</p> <p>Power supply 90-264Vac (universal), integrated (no external brick-like power supply), 30 watts typical, <2 watts standby/suspend</p> <p>Limited warranty⁴ 3 year (includes backlight)</p> <p>Available date November 2007</p>	<ul style="list-style-type: none"> • All-purpose 19-inch flat panel monitor • EPEAT™ Gold rating • High-bandwidth Digital Content Protection (HDCP)-compliant • Slim 15.2 mm (0.60") side bezel • Carrying handle • Ergonomic stand tilts, swivels, pivots and provides a 110mm range height adjustment for comfortable viewing • Quick and easy monitor adjustments with on-screen-display via OnScreen Manager™ (<i>soft OSM™</i>) • Includes dual input connection for attachment to two systems concurrently (analog and digital) • Rear stand cover and clip to hide cables • Complements the ThinkCentre® and ThinkPad® systems • Microsoft® Windows® Vista™ Premium certified
	 <p>Lenovo ThinkVision L193p</p>

Limited Warranty	Accessories										
<ul style="list-style-type: none"> ⇒ 3 year limited warranty⁴ ⇒ International Warranty Service⁵ ⇒ Rapid Replacement Service at 1-800-IBM-SERV (426-7378) ⇒ Replacement normally arrives in two business days, excluding holidays ⇒ Lenovo pays all shipping costs for valid warranty claims⁶ ⇒ Service upgrade options:⁷ <ul style="list-style-type: none"> • 3 year, on site exchange, Mon-Fri 9-5 with next day response (ThinkPlus™ part number 41C9209) • 3 year, on site exchange, 7 day x 24 hr with 4 hour response (41C9212) • 4 year, on site exchange, Mon-Fri 9-5 with next day response (41C9233) • 4 year, on site exchange, 7 day x 24 hr with 4 hour response (41C9234) ⇒ 24x7⁸ day toll-free support for warranty issues during the warranty period⁴ 	<table style="width: 100%; border-collapse: collapse;"> <tr> <td>ThinkVision® USB Soundbar</td> <td style="text-align: right;">40Y7616</td> </tr> <tr> <td>Kensington® MicroSaver® Security Cable Lock</td> <td style="text-align: right;">73P2582</td> </tr> <tr> <td>Kensington Twin Head Cable Lock</td> <td style="text-align: right;">45K1620</td> </tr> <tr> <td>ThinkPad Convertible Monitor Stand</td> <td style="text-align: right;">40Y7620</td> </tr> <tr> <td>ThinkVision TFT Radial Arm⁹</td> <td style="text-align: right;">19K4464</td> </tr> </table> <p>See details at www.lenovo.com/support/monitoraccessories</p> <p>See all monitors at www.lenovo.com/thinkvision</p>	ThinkVision® USB Soundbar	40Y7616	Kensington® MicroSaver® Security Cable Lock	73P2582	Kensington Twin Head Cable Lock	45K1620	ThinkPad Convertible Monitor Stand	40Y7620	ThinkVision TFT Radial Arm ⁹	19K4464
ThinkVision® USB Soundbar	40Y7616										
Kensington® MicroSaver® Security Cable Lock	73P2582										
Kensington Twin Head Cable Lock	45K1620										
ThinkPad Convertible Monitor Stand	40Y7620										
ThinkVision TFT Radial Arm ⁹	19K4464										

See footnotes for important warranty information
 US model announced October 23, 2007

Flat Panel Monitors - US model		Features
Name	L194 Wide Flat Panel Monitor	<ul style="list-style-type: none"> • Widescreen 19-inch flat panel monitor • EPEAT™ Gold rating • View images in a 16:10 wide aspect ratio • Resolution of 1440x900 provides crisp screen images • Slim 14.3mm (0.56") side bezel • High-bandwidth Digital Content Protection (HDCP)-compliant • Includes dual input connection for attachment to two systems concurrently (analog and digital) • Complements the ThinkCentre® and ThinkPad® systems • Microsoft® Windows® Vista™ Premium certified
Case color	Business black	
Type-model	4434-HB6	
Stand	Tilt stand	
Screen	LCD Active Matrix TFT (Thin Film Transistor)	
Viewable image size (diag)	19.0" / 481mm (diagonal)	
Aspect ratio	16:10	
Pixel pitch (mm)	.285mm	
Max view area (inches)	16.1" x 10.0" (horizontal x vertical)	
Max view area (mm)	408mm x 255mm (horizontal x vertical)	
Viewing angle at 5:1 CR	176° (+/- 88°) vertical, 176° (+/- 88°) horizontal	
Viewing angle at 10:1 CR	160° (+/- 80°) vertical, 160° (+/- 80°) horizontal	
Video input	Digital or analog (two separate connectors)	
Dual input	Dual input (two different PCs attach to two different connectors; one PC shows image; select via button)	
Rotating screen	No pivot	
USB Hub	None	
Optimum resolution	1440x900 at 60Hz	
Maximum resolution	1440x900 at 75Hz (137MHz maximum pixel rate)	
Vertical frequency	50 to 76Hz	
Horizontal frequency	30 to 81kHz	
Preset display modes	VGA: 640x480 60, 66, 72, 75Hz 640x350 70Hz 720x400 70Hz SVGA: 800x600 56, 60, 72, 75Hz 832x624 75Hz XGA: 1024x768 60, 70, 75Hz 1152x864 75Hz SXGA: 1280x1024 60, 70, 75Hz WXGA+: 1440x900 60, 75Hz	
Presets / user settings	Standard presets: 20; user settings: 20	
Brightness	300 nits or cd/m ² (typical)	
Contrast ratio	1000:1 (typical)	
Pixel response time	5ms (typical)	
On screen display	On screen display with digital user controls (7 languages)	
Control features	Direct access (buttons on front) for automatic image setup	
Monitor connectors	Two connectors: (1) analog VGA 15-pin D-shell [blue], (2) Digital Visual Interface (DVI-D) for digital (not analog) attach [white], HDCP-compliant	
Signal cables	Two cables: (1) detachable, VGA 15-pin D-shell at each end (for analog connector), 1.8 meter, matches color of monitor (2) detachable digital, DVI-D at each end (for digital connector), 1.8 meter, matches color of monitor	
Anti-reflective	Anti-reflective, anti-glare	
Dimensions	15.0"H x 17.3"W x 7.0"D / 381mm height x 440mm width x 179mm depth	
Weight	9.1lb / 4.15kg	
Viewing adjustments	Tilt: 30° back, 4° forward / no lift, no swivel, detachable stand	
Mounting features	Wall or desk mounting using the Radial Arm® or third-party accessories meeting the VESA FPMPLI® (100mm mount)	
Security	Security keyhole for attachment of optional cable lock (Kensington® lock-compatible)	
VESA-compliant ²	VESA DDC2B/CI, VESA DPMS-compliant	
Power management	ENERGY STAR® 4.0	
Ergonomics	ISO 13406 Part 2 ¹	
Pixel defect	ISO 13406-2 Class II pixel defect standard	
Emission standards	MPR-2, MPR-3A, FCC Class B	
Environmental	TCO 03, WEEE, RoHS (EU Directive 2002/95/EC), EPEAT™ Gold rating	
Ship group	Monitor, attached stand, Setup Guide, Safety and Warranty Information, CD with multilingual User's Guide and monitor installation files, analog signal cable, digital signal cable, 1.8m black power cord	
Power supply	90-264Vac (universal), integrated (no external brick-like power supply), 29 watts typical, <2 watts standby/suspend	
Limited warranty ⁴	3 year (includes backlight)	
Available date	October 2007	



Lenovo ThinkVision L194 Wide

Limited Warranty	Accessories										
<ul style="list-style-type: none"> ↪ 3 year limited warranty⁴ ↪ International Warranty Service⁵ ↪ Rapid Replacement Service at 1-800-IBM-SERV (426-7378) ↪ Replacement normally arrives in two business days, excluding holidays ↪ Lenovo pays all shipping costs for valid warranty claims⁶ ↪ Service upgrade options:⁷ <ul style="list-style-type: none"> • 3 year, on site exchange, Mon-Fri 9-5 with next day response (ThinkPlus™ part number 41C9209) • 3 year, on site exchange, 7 day x 24 hr with 4 hour response (41C9212) • 4 year, on site exchange, Mon-Fri 9-5 with next day response (41C9233) • 4 year, on site exchange, 7 day x 24 hr with 4 hour response (41C9234) ↪ 24x7⁸ day toll-free support for warranty issues during the warranty period⁴ 	<table border="0"> <tr> <td>ThinkVision® USB Soundbar</td> <td>40Y7616</td> </tr> <tr> <td>Kensington® MicroSaver® Security Cable Lock</td> <td>73P2582</td> </tr> <tr> <td>Kensington Twin Head Cable Lock</td> <td>45K1620</td> </tr> <tr> <td>ThinkPad Convertible Monitor Stand</td> <td>40Y7620</td> </tr> <tr> <td>ThinkVision TFT Radial Arm⁹</td> <td>19K4464</td> </tr> </table> <p>See details at www.lenovo.com/support/monitoraccessories</p> <p>See all monitors at www.lenovo.com/thinkvision</p>	ThinkVision® USB Soundbar	40Y7616	Kensington® MicroSaver® Security Cable Lock	73P2582	Kensington Twin Head Cable Lock	45K1620	ThinkPad Convertible Monitor Stand	40Y7620	ThinkVision TFT Radial Arm ⁹	19K4464
ThinkVision® USB Soundbar	40Y7616										
Kensington® MicroSaver® Security Cable Lock	73P2582										
Kensington Twin Head Cable Lock	45K1620										
ThinkPad Convertible Monitor Stand	40Y7620										
ThinkVision TFT Radial Arm ⁹	19K4464										

See footnotes for important warranty information
US model announced October 9, 2007

Flat Panel Monitors - US model		Features
Name	L197 Wide Flat Panel Monitor	<ul style="list-style-type: none"> • Widescreen 19-inch flat panel monitor • EPEAT™ Gold rating • View images in a 16:10 wide aspect ratio • Resolution of 1440x900 provides crisp screen images • Slim 14.3mm (0.56") side bezel • High-bandwidth Digital Content Protection (HDCP)-compliant • Includes dual input connection for attachment to two systems concurrently (analog and digital) • Complements the ThinkCentre® and ThinkPad® systems • Microsoft® Windows® Vista™ Premium certified
Case color	Business black	
Type-model	4434-HE1	
Stand	Tilt stand	
Screen	LCD Active Matrix TFT (Thin Film Transistor)	
Viewable image size (diag)	19.0" / 481mm (diagonal)	
Aspect ratio	16:10	
Pixel pitch (mm)	.285mm	
Max view area (inches)	16.1" x 10.0" (horizontal x vertical)	
Max view area (mm)	408mm x 255mm (horizontal x vertical)	
Viewing angle at 5:1 CR	176° vertical, 176° horizontal	
Viewing angle at 10:1 CR	160° vertical, 170° horizontal	
Video input	Digital or analog (two separate connectors)	
Dual input	Dual input (two different PCs attach to two different connectors; one PC shows image; select via button)	
Rotating screen	No pivot	
USB Hub	None	
Optimum resolution	1440x900 at 60Hz	
Maximum resolution	1440x900 at 75Hz (137MHz maximum pixel rate)	
Vertical frequency	50 to 76Hz	
Horizontal frequency	30 to 81kHz	
Preset display modes	VGA: 640x480 60, 66, 72, 75Hz 640x350 70Hz 720x400 70Hz SVGA: 800x600 56, 60, 72, 75Hz 832x624 75Hz XGA: 1024x768 60, 70, 75Hz 1152x864 75Hz SXGA: 1280x1024 60, 70, 75Hz WXGA+: 1440x900 60, 75Hz	
Presets / user settings	Standard presets: 20; user settings: 20	
Brightness	250 nits or cd/m ² (typical)	
Contrast ratio	1000:1 (typical)	
Pixel response time	5ms (typical)	
Color gamut	72%	
On screen display	On screen display with digital user controls (7 languages)	
Control features	Direct access (buttons on front) for automatic image setup	
Monitor connectors	Two connectors: (1) analog VGA 15-pin D-shell [blue], (2) Digital Visual Interface (DVI-D) for digital (not analog) attach [white], HDCP-compliant	
Signal cables	Two cables: (1) detachable, VGA 15-pin D-shell at each end (for analog connector), 1.8 meter, matches color of monitor (2) detachable digital, DVI-D at each end (for digital connector), 1.8 meter, matches color of monitor	
Anti-reflective	Anti-reflective, anti-glare	
Dimensions	15.0"H x 17.3"W x 7.0"D / 381mm height x 440mm width x 179mm depth	
Weight	9.15lb / 4.15kg	
Viewing adjustments	Tilt: 30° back, 4° forward / no lift, no swivel, detachable stand	
Mounting features	Wall or desk mounting using the Radial Arm ⁹ or third-party accessories meeting the VESA FPMPI [®] (100mm mount)	
Security	Security keyhole for attachment of optional cable lock (Kensington [®] lock-compatible)	
VESA-compliant ²	VESA DDC2B/C1, VESA DPMS-compliant	
Power management	ENERGY STAR ^{®3} 4.1 Tier 2	
Ergonomics	ISO 13406 Part 2 ¹	
Pixel defect	ISO 13406-2 Class II pixel defect standard	
Emission standards	MPR-2, MPR-3A, FCC Class B	
Environmental	TCO 03, WEEE, RoHS (EU Directive 2002/95/EC), EPEAT™ Gold rating	
Ship group	Monitor, attached stand, Setup Guide, Safety and Warranty Information, CD with multilingual User's Guide and monitor installation files, analog signal cable, digital signal cable, 1.8m black power cord	
Power supply	90-264Vac (universal), integrated (no external brick-like power supply), 22 watts typical, <2 watts standby/suspend	
Limited warranty ⁴	3 year (includes backlight)	
Available date	April 2008	



Lenovo ThinkVision L197 Wide

Limited Warranty	Accessories										
<ul style="list-style-type: none"> ⇒ 3 year limited warranty⁴ ⇒ International Warranty Service⁵ ⇒ Rapid Replacement Service at 1-800-IBM-SERV (426-7378) ⇒ Replacement normally arrives in two business days, excluding holidays ⇒ Lenovo pays all shipping costs for valid warranty claims⁶ ⇒ Service upgrade options:⁷ <ul style="list-style-type: none"> • 3 year, on site exchange, Mon-Fri 9-5 with next day response (ThinkPlus™ part number 41C9209) • 3 year, on site exchange, 7 day x 24 hr with 4 hour response (41C9212) • 4 year, on site exchange, Mon-Fri 9-5 with next day response (41C9233) • 4 year, on site exchange, 7 day x 24 hr with 4 hour response (41C9234) ⇒ 24x7⁸ day toll-free support for warranty issues during the warranty period⁴ 	<table border="0"> <tr> <td>ThinkVision® USB Soundbar</td> <td>40Y7616</td> </tr> <tr> <td>Kensington® MicroSaver® Security Cable Lock</td> <td>73P2582</td> </tr> <tr> <td>Kensington Twin Head Cable Lock</td> <td>45K1620</td> </tr> <tr> <td>ThinkPad Convertible Monitor Stand</td> <td>40Y7620</td> </tr> <tr> <td>ThinkVision TFT Radial Arm⁹</td> <td>19K4464</td> </tr> </table> <p>See details at www.lenovo.com/support/monitoraccessories</p> <p>See all monitors at www.lenovo.com/thinkvision</p>	ThinkVision® USB Soundbar	40Y7616	Kensington® MicroSaver® Security Cable Lock	73P2582	Kensington Twin Head Cable Lock	45K1620	ThinkPad Convertible Monitor Stand	40Y7620	ThinkVision TFT Radial Arm ⁹	19K4464
ThinkVision® USB Soundbar	40Y7616										
Kensington® MicroSaver® Security Cable Lock	73P2582										
Kensington Twin Head Cable Lock	45K1620										
ThinkPad Convertible Monitor Stand	40Y7620										
ThinkVision TFT Radial Arm ⁹	19K4464										

See footnotes for important warranty information
US model announced April 15, 2008

<p>Name L1900p Flat Panel Monitor Case color Business black Type-model 4431-HE1 Panel TFT-LCD, twisted nematic (TN), CCFL backlight Viewable image size 19.0" (483mm) diagonal Max view area (W x H) 14.8" x 11.85" (376mm x 301mm) Optimum resolution 1280x1024 at 60Hz Maximum resolution 1280x1024 at 75Hz (135MHz max pixel rate) Aspect ratio 5:4 Pixel pitch (mm) .294mm Dot/Pixel per Inch 86 dpi Brightness 250 nits or cd/m² (typical) Contrast ratio 800:1 (typical) Pixel response time 5ms (typical) Color gamut 72% Anti-reflective Anti-reflective, anti-glare Vertical frequency 56 to 76Hz Horizontal frequency 30 to 81kHz Viewing angle at 10:1 CR 160° (+/- 80°) horizontal, 160° (+/- 80°) vertical Stand Tilt, swivel, pivot, and height adjustable stand Bezel width <i>Sides: 0.6" (15.3mm); top: 0.66" (16.8mm); bottom: 1.05" (26.8mm)</i> Dimensions (HxWxD) 14.9-19.2" H x 16.1" W x 7.4-9.5" D; 378.7-488.7mm H x 408mm W x 188-241.1mm D Power supply 17 watts typical, 24 watts maximum, <1 watts standby/suspend, universal, integrated (no external brick-like power supply) Weight 12.5 lb; 5.7kg Limited warranty⁴ 3 year (includes backlight) Available date November 2008</p>	<p style="text-align: center;">Features</p> <ul style="list-style-type: none"> • Regular screen 19-inch monitor • Supports SXGA 1280x1024 resolution • Ergonomic stand tilts, swivels, pivots and provides a 4.3" (110mm) range height adjustment for comfortable viewing • Detachable rear stand cable cover and clip to hide cables • Microsoft® Windows® Vista® certified <div style="text-align: center;">  <p>ThinkVision L1900p Monitor with optional ThinkVision Soundbar</p> </div>										
<p>VESA-compliant² VESA DDC2B/CI, VESA DPMS-compliant Power management ENERGY STAR^{®3} 4.1 Tier 2 Ergonomics ISO 13406 Part 2¹ Pixel defect ISO 13406-2 Class II pixel defect standard Emission standards MPR-2, MPR-3A, FCC Class B Environmental TCO 03, WEEE, RoHS (EU Directive 2002/95/EC), EPEAT™ Gold rating, GREENGUARD® certified</p>	<p>Preset resolutions VGA: 640x350, 640x480, 720x400 SVGA: 800x600 XGA: 1024x768 SXGA: 1280x1024 Presets / user settings Standard presets: 21; user settings: 17</p> <p>Viewing adjustments <i>Tilt: 30° back, 0° forward; lift: 4.3" (110mm); swivel: +/-45°; detachable stand</i> Rotating screen Screen pivots 90 degrees from landscape to portrait (requires image rotation support from graphics controller) On screen display On screen display with digital user controls (8 languages) Control features Direct access (buttons on front) for automatic image setup Multiple input Multiple input (two different PCs attach to two different connectors; one PC shows image; select via button) Monitor connectors (1) VGA 15-pin D-shell, analog, blue (2) Digital Visual Interface (DVI-D), digital, white, HDCP-compliant Signal cables (1) detachable, VGA 15-pin D-shell at each end, analog, 1.8 meter (2) detachable, DVI-D at each end, digital, 1.8 meter Mounting features Wall or desk mounting using the Radial Arm⁹ or third-party accessories meeting the VESA FPMPI[®] (100mm mount) Security Security keyhole for attachment of optional cable lock (Kensington® lock-compatible)</p> <p>Ship group Monitor, attached stand, cable cover, Setup poster, Safety and Warranty Information, CD with multilingual User's Guide and monitor installation files, 1.8 meter analog signal cable, 1.8 meter digital signal cable, 1.8 meter black power cord</p>										
<p style="text-align: center;">Limited Warranty</p> <ul style="list-style-type: none"> ↪ 3 year limited warranty⁴ ↪ International Warranty Service⁵ ↪ Rapid Replacement Service at 1-800-IBM-SERV (426-7378) ↪ Replacement normally arrives in two business days, excluding holidays ↪ Lenovo pays all shipping costs for valid warranty claims⁶ ↪ Service upgrade options⁷ <ul style="list-style-type: none"> • 3 year, on site exchange, Mon-Fri 9-5 with next day response (ThinkPlus™ part number 41C9209) • 3 year, on site exchange, 7 day x 24 hr with 4 hour response (41C9212) • 4 year, on site exchange, Mon-Fri 9-5 with next day response (41C9233) • 4 year, on site exchange, 7 day x 24 hr with 4 hour response (41C9234) ↪ 24x7⁸ day toll-free support for warranty issues during the warranty period⁴ 	<p style="text-align: center;">Accessories</p> <table border="0"> <tr> <td>ThinkVision Soundbar (L1900p, 24" Wide)</td> <td style="text-align: right;">45K1263</td> </tr> <tr> <td>Kensington® Cable Lock from Lenovo</td> <td style="text-align: right;">73P2582</td> </tr> <tr> <td>Kensington Twin Head Cable Lock</td> <td style="text-align: right;">45K1620</td> </tr> <tr> <td>ThinkPad Convertible Monitor Stand</td> <td style="text-align: right;">40Y7620</td> </tr> <tr> <td>ThinkVision TFT Radial Arm⁹</td> <td style="text-align: right;">19K4464</td> </tr> </table> <p>See details at www.lenovo.com/support/monitoraccessories</p> <p>See all monitors at www.lenovo.com/thinkvision</p>	ThinkVision Soundbar (L1900p, 24" Wide)	45K1263	Kensington® Cable Lock from Lenovo	73P2582	Kensington Twin Head Cable Lock	45K1620	ThinkPad Convertible Monitor Stand	40Y7620	ThinkVision TFT Radial Arm ⁹	19K4464
ThinkVision Soundbar (L1900p, 24" Wide)	45K1263										
Kensington® Cable Lock from Lenovo	73P2582										
Kensington Twin Head Cable Lock	45K1620										
ThinkPad Convertible Monitor Stand	40Y7620										
ThinkVision TFT Radial Arm ⁹	19K4464										

See footnotes for important warranty information
 US model announced November 11, 2008

<p>Name L1940p Wide Flat Panel Monitor Case color Business black Type-model 4424-HB6 Panel TFT-LCD, twisted nematic (TN), CCFL backlight Viewable image size 19.0" (481mm) diagonal Max view area (W x H) 16.1" x 10" (408.2mm x 255.2mm) Optimum resolution 1440x900 at 60Hz Maximum resolution 1440x900 at 75Hz (137MHz max pixel rate) Aspect ratio 16:10 Pixel pitch (mm) .285mm Dot/Pixel per Inch 89 dpi Brightness 250 nits or cd/m² (typical) Contrast ratio 1000:1 (typical) Pixel response time 5ms (typical) Color gamut 72% Anti-reflective Anti-reflective, anti-glare Vertical frequency 50 to 76Hz Horizontal frequency 30 to 81kHz Viewing angle at 10:1 CR 160° (+/- 80°) horizontal, 160° (+/- 80°) vertical Stand Tilt, swivel, pivot, and height adjustable stand Bezel width Sides: 0.61" (15.4mm); top: 0.65" (16.4mm); bottom: 1.1" (27.9mm) Dimensions (HxWxD) 14-18.3" H x 17.3" W x 7.4-9.5" D; 356.1-466.1mm H x 440.2mm W x 188-241.1mm D Power supply 16 watts typical, 23 watts maximum, <1 watts standby/suspend, universal, integrated (no external brick-like power supply) Weight 12.8 lb; 5.8kg Limited warranty⁴ 3 year (includes backlight) Available date October 2008</p>	<p>Features</p> <ul style="list-style-type: none"> • Widescreen 19-inch monitor • Supports WXGA+ 1440x900 resolution • Ergonomic stand tilts, swivels, pivots and provides a 4.3" (110mm) range height adjustment for comfortable viewing • Detachable rear stand cable cover and clip to hide cables • Microsoft® Windows® Vista® certified 										
<p>VESA-compliant² VESA DDC2B/CI, VESA DPMS-compliant Power management ENERGY STAR[®] 4.1 Tier 2 Ergonomics ISO 13406 Part 2¹ Pixel defect ISO 13406-2 Class II pixel defect standard Emission standards MPR-2, MPR-3A, FCC Class B Environmental TCO 03, WEEE, RoHS (EU Directive 2002/95/EC), EPEAT™ Gold rating, GREENGUARD® certified</p>	 <p>ThinkVision L1940p Wide Monitor</p>										
<p>Preset resolutions VGA: 640x350, 640x480, 720x400 SVGA: 800x600, 832x624 XGA: 1024x768, 1152x864 WXGA: 1280x720, 1280x768 SXGA: 1280x1024 WXGA+: 1440x900 Presets / user settings Standard presets: 22; user settings: 20</p>											
<p>Viewing adjustments Tilt: 30° back, 0° forward; lift: 4.3" (110mm); swivel: +/-45°; detachable stand Rotating screen Screen pivots 90 degrees from landscape to portrait (requires image rotation support from graphics controller), On screen display On screen display with digital user controls (8 languages) Control features Direct access (buttons on front) for automatic image setup Multiple input Multiple input (two different PCs attach to two different connectors; one PC shows image; select via button) Monitor connectors (1) VGA 15-pin D-shell, analog, blue (2) Digital Visual Interface (DVI-D), digital, white, HDCP-compliant Signal cables (1) detachable, VGA 15-pin D-shell at each end, analog, 1.8 meter (2) detachable, DVI-D at each end, digital, 1.8 meter Mounting features Wall or desk mounting using the Radial Arm⁹ or third-party accessories meeting the VESA FPMPI[®] (100mm mount) Security Security keyhole for attachment of optional cable lock (Kensington® lock-compatible)</p>											
<p>Ship group Monitor, attached stand, cable cover, Setup poster, Safety and Warranty Information, CD with multilingual User's Guide and monitor installation files, 1.8 meter analog signal cable, 1.8 meter digital signal cable, 1.8 meter black power cord</p>											
<p>Limited Warranty</p> <ul style="list-style-type: none"> ⇒ 3 year limited warranty⁴ ⇒ International Warranty Service⁵ ⇒ Rapid Replacement Service at 1-800-IBM-SERV (426-7378) ⇒ Replacement normally arrives in two business days, excluding holidays ⇒ Lenovo pays all shipping costs for valid warranty claims⁶ ⇒ Service upgrade options:⁷ <ul style="list-style-type: none"> • 3 year, on site exchange, Mon-Fri 9-5 with next day response (ThinkPlus™ part number 41C9209) • 3 year, on site exchange, 7 day x 24 hr with 4 hour response (41C9212) • 4 year, on site exchange, Mon-Fri 9-5 with next day response (41C9233) • 4 year, on site exchange, 7 day x 24 hr with 4 hour response (41C9234) ⇒ 24x7⁸ day toll-free support for warranty issues during the warranty period⁴ 	<p>Accessories</p> <table border="0"> <tr> <td>ThinkVision USB Soundbar</td> <td>40Y7616</td> </tr> <tr> <td>Kensington® Cable Lock from Lenovo</td> <td>73P2582</td> </tr> <tr> <td>Kensington Twin Head Cable Lock</td> <td>45K1620</td> </tr> <tr> <td>ThinkPad Convertible Monitor Stand</td> <td>40Y7620</td> </tr> <tr> <td>ThinkVision TFT Radial Arm⁹</td> <td>19K4464</td> </tr> </table> <p>See details at www.lenovo.com/support/monitoraccessories</p> <p>See all monitors at www.lenovo.com/thinkvision</p>	ThinkVision USB Soundbar	40Y7616	Kensington® Cable Lock from Lenovo	73P2582	Kensington Twin Head Cable Lock	45K1620	ThinkPad Convertible Monitor Stand	40Y7620	ThinkVision TFT Radial Arm ⁹	19K4464
ThinkVision USB Soundbar	40Y7616										
Kensington® Cable Lock from Lenovo	73P2582										
Kensington Twin Head Cable Lock	45K1620										
ThinkPad Convertible Monitor Stand	40Y7620										
ThinkVision TFT Radial Arm ⁹	19K4464										

See footnotes for important warranty information
 US model announced September 17, 2008

Flat Panel Monitors - US model	Features										
<p>Name L200p Wide Flat Panel Monitor Case color Business black Type-model 4438-HB6 Stand Tilt, swivel, pivot, and height adjustable stand Screen LCD Active Matrix TFT (Thin Film Transistor) Viewable image size (diag) 20.1" / 51mm (diagonal) Aspect ratio 16:10 Pixel pitch (mm) .258mm Max view area (inches) 17.0" x 10.7" (horizontal x vertical) Max view area (mm) 433mm x 271mm (horizontal x vertical) Viewing angle at 5:1 CR 160° (+70°/- 80°) vertical, 160° (+70°/- 80°) horizontal Viewing angle at 10:1 CR 160° (+70°/- 80°) vertical, 160° (+70°/- 80°) horizontal Video input Digital or analog (two separate connectors) Dual input Dual input (two different PCs attach to two different connectors; one PC shows image; select via button) Rotating screen Screen pivots 90 degrees from landscape to portrait (requires image rotation support from graphics controller), auto-rotation without software</p>	<p>Features</p> <ul style="list-style-type: none"> • Widescreen 20.1-inch flat panel monitor • EPEAT™ Gold rating • View images in a 16:10 wide aspect ratio • Resolution of 1680x1050 provides crisp screen images • Slim 17.9mm (0.7") side bezel • High-bandwidth Digital Content Protection (HDCP)-compliant • Ergonomic stand tilts, swivels, pivots and provides a 110mm range height adjustment for comfortable viewing • Includes dual input connection for attachment to two systems concurrently (analog and digital) • Complements the ThinkCentre® and ThinkPad® systems • Microsoft® Windows® Vista™ Premium certified 										
<p>USB Hub Optimum resolution 1680x1050 at 60Hz Maximum resolution 1680x1050 at 75Hz (190MHz maximum pixel rate) Vertical frequency 50 to 75Hz Horizontal frequency 30 to 83kHz Preset display modes Presets / user settings Brightness Contrast ratio Pixel response time Color gamut</p>	<p>VGA: 640x480 60, 66, 72, 75Hz 640x350 70Hz 720x400 70Hz SVGA: 800x600 60, 72, 75Hz XGA: 1024x768 60, 70, 75Hz 1152x864 75Hz SXGA: 1280x1024 60, 72, 75Hz WXGA+: 1440x900 60, 75Hz WSXGA+: 1680x1050 60, 75Hz Standard presets: 20; user settings: 20 300 nits or cd/m² (typical) 1000:1 (typical) 5ms (typical) 72%</p>										
<p>On screen display Control features Monitor connectors Signal cables Anti-reflective Dimensions Weight Viewing adjustments Mounting features Security</p>	<p>(1) On screen display with digital user controls (7 languages) (2) EnTech Taiwan OnScreen Manager™ (<i>soft OSM™</i>) Direct access (buttons on front) for automatic image setup Two connectors: (1) analog VGA 15-pin D-shell [blue], (2) Digital Visual Interface (DVI-D) for digital (not analog) attach [white], HDCP-compliant Two cables: (1) detachable, VGA 15-pin D-shell at each end (for analog connector), 2.2 meter, matches color of monitor (2) detachable digital, DVI-D at each end (for digital connector), 2.2 meter, matches color of monitor Anti-reflective, anti-glare 14.4"H x 18.5"W x 9.6"D / 366mm height x 471mm width x 245mm depth 13lb / 5.9kg Tilt: 30° back, 0° forward / lift: 4.3" (110mm) / swivel: +/-45° / detachable stand Wall or desk mounting using the Radial Arm® or third-party accessories meeting the VESA FPMPI® (100mm mount) Security keyhole for attachment of optional cable lock (Kensington® lock-compatible)</p>										
<p>VESA-compliant² Power management Ergonomics Pixel defect Emission standards Environmental Ship group Power supply Limited warranty⁴ Available date</p>	<p>VESA DDC2B/C1, VESA DPMS-compliant ENERGY STAR® 4.1 Tier 2 ISO 13406 Part 2¹ ISO 13406-2 Class II pixel defect standard MPR-2, MPR-3A, FCC Class B TCO 03, WEEE, RoHS (EU Directive 2002/95/EC), EPEAT™ Gold rating Monitor, attached stand, Setup Guide, Safety and Warranty Information, CD with multilingual User's Guide and monitor installation files, analog signal cable, digital signal cable, 1.8m black power cord 100-240Vac (universal), integrated (no external brick-like power supply), 42 watts typical, <2 watts standby/suspend 3 year (includes backlight) May 2008</p>										
<p>Limited Warranty</p> <ul style="list-style-type: none"> ↪ 3 year limited warranty⁴ ↪ International Warranty Service⁵ ↪ Rapid Replacement Service at 1-800-IBM-SERV (426-7378) ↪ Replacement normally arrives in two business days, excluding holidays ↪ Lenovo pays all shipping costs for valid warranty claims⁶ ↪ Service upgrade options:⁷ <ul style="list-style-type: none"> • 3 year, on site exchange, Mon-Fri 9-5 with next day response (ThinkPlus™ part number 41C9209) • 3 year, on site exchange, 7 day x 24 hr with 4 hour response (41C9212) • 4 year, on site exchange, Mon-Fri 9-5 with next day response (41C9233) • 4 year, on site exchange, 7 day x 24 hr with 4 hour response (41C9234) ↪ 24x7⁸ day toll-free support for warranty issues during the warranty period⁴ 	<p>Accessories</p> <table border="0"> <tr> <td>ThinkVision® USB Soundbar</td> <td>40Y7616</td> </tr> <tr> <td>Kensington® MicroSaver® Security Cable Lock</td> <td>73P2582</td> </tr> <tr> <td>Kensington Twin Head Cable Lock</td> <td>45K1620</td> </tr> <tr> <td>ThinkPad Convertible Monitor Stand</td> <td>40Y7620</td> </tr> <tr> <td>ThinkVision TFT Radial Arm⁹</td> <td>19K4464</td> </tr> </table> <p>See details at www.lenovo.com/support/monitoraccessories</p> <p>See all monitors at www.lenovo.com/thinkvision</p>	ThinkVision® USB Soundbar	40Y7616	Kensington® MicroSaver® Security Cable Lock	73P2582	Kensington Twin Head Cable Lock	45K1620	ThinkPad Convertible Monitor Stand	40Y7620	ThinkVision TFT Radial Arm ⁹	19K4464
ThinkVision® USB Soundbar	40Y7616										
Kensington® MicroSaver® Security Cable Lock	73P2582										
Kensington Twin Head Cable Lock	45K1620										
ThinkPad Convertible Monitor Stand	40Y7620										
ThinkVision TFT Radial Arm ⁹	19K4464										



Lenovo ThinkVision L200p Wide

See footnotes for important warranty information
 US model announced April 15, 2008

Flat Panel Monitors - US model		Positioning
<p>Name Lenovo D221 Wide Flat Panel Monitor Case color Business black Type-model 6622-HB1 US Govt model (TAA)¹⁰ No Stand Tilt stand Screen LCD Active Matrix TFT (Thin Film Transistor) Viewable image size 22.0" / 559mm (diagonal) Aspect ratio 16:10 Pixel pitch (mm) 0.282mm Max view area (inches) 18.7" x 11.6" (horizontal x vertical) Max view area (mm) 474mm x 296mm (horizontal x vertical) Viewing angle at 5:1 CR 176° vertical, 176° horizontal Viewing angle at 10:1 CR 160° vertical, 160° horizontal Video input Digital or analog (two separate connectors) Dual input Dual input (two different PCs attach to two different connectors; one PC shows image; select via button) Rotating screen None</p>	<p>Optimum resolution 1680x1050 at 60Hz Maximum resolution 1680x1050 at 60Hz (146MHz maximum pixel rate) Vertical frequency 56 to 76Hz Horizontal frequency 30 to 83kHz Display colors (maximum) 16.7 million simultaneous colors Preset display modes VGA: 640x480 60, 72, 75Hz 720x400 70Hz SVGA: 800x600 56, 60Hz, 75 832x624 75Hz XGA: 1024x768 60, 70, 75 Hz 1152x864 75Hz SXGA: 1280x1024 60, 70, 75, 76Hz WSXGA+: 1680x1050 60</p> <p>Presets / user settings Standard presets: 17; user settings: 15 Brightness 300 nits or cd/m² (typical) Contrast ratio 700:1 (typical) Pixel response time 5ms (typical) Scaling Automatically expands image of lower resolution to full screen of 1680x1050</p>	<p>• The Lenovo D221 Wide monitor is best suited for general business applications.</p> <p>Features</p> <ul style="list-style-type: none"> • All-purpose 22-inch wide flat panel LCD monitor • View six more spreadsheet columns compared with standard 19" flat panel monitors • View two actual-size A4 pages side by side • View images in a 16x10 wide aspect ratio • Slim 19.6mm (0.77") side bezel • Resolution of 1680x1050 provides crisp screen images • Stand tilts for comfortable viewing • Direct access for automatic image setup and brightness • Quick and easy monitor adjustments using on-screen-display • Matching design to Lenovo notebooks and desktops • A great replacement for a 17" or 19" CRT or LCD monitor • Scaling allows full screen viewing of resolutions less than 1680x1050 • Integrated power supply eliminates the bulky power adapter for improved cable management • Lockable digital controls
<p>On screen display On screen display with digital user controls (7 languages) Control features Direct access (buttons on front) for auto adjustment and brightness; contrast; image horizontal and vertical position; user color settings (3 preset + 1 user); on screen display (OSD) language selection; menu position; information screen; image setup; reset of geometry and color point to factory default settings; lockable settings</p> <p>Monitor connectors Two connector: (1) analog VGA 15-pin D-shell [blue], (2) Digital Visual Interface (DVI-D) for digital attach [white] Signal cable Two cables: (1) detachable, VGA 15-pin D-shell at each end (for analog connector), 1.8 meter, matches color of monitor (2) detachable, DVI-D at each end (for digital connector), 1.8 meter, matches color of monitor</p> <p>Anti-reflective / anti-glare Anti-reflective / anti-glare Dimensions 16.0" H x 20.25" W x 9.4" D / 406mm height x 514mm width x 240mm depth Weight 13.7 lb / 6.2 kg Viewing adjustments Tilt: 20° back, 5° forward / no swivel / no lift / detachable stand Mounting features Wall or desk mounting using the TFT Radial Arm⁹ or third-party accessories meeting the VESA FPMPI[®] (100mm mount) Security Security keyhole for attachment of optional cable lock (such as Kensington[®] Microsaver[®] lock)</p>	<p>VESA DDC² 2B/CI VESA DPMS-compliant DPMS Power management ENERGY STAR[®] 4.0 Ergonomics ISO 13406 Part 2¹ Pixel defect ISO 13406-2 Class II pixel defect standard Emission standards MPR-2 / MPR-3A / FCC Class B Environmental label TCO 99 / WEEE / RoHS (EU Directive 2002/95/EC) Ship group Monitor, attached stand, customer installable base, Setup Guide, Safety and Warranty Information, CD with multilingual User's Guide and monitor installation files, analog signal cable, digital signal cable, 1.8m black power cord</p> <p>Power supply 100-240Vac (universal) / integrated (no external brick-like power supply) / 45 watts typical (<2 watts for "active off") Limited warranty⁴ 3 year (includes backlight) Available date December 2006</p>	
<p>Limited Warranty</p> <ul style="list-style-type: none"> ↪ 3-year limited warranty⁴ ↪ International Warranty Service⁵ ↪ Rapid Replacement Service at 1-800-IBM-SERV (426-7378) ↪ Replacement normally arrives in two business days, excluding holidays ↪ Lenovo pays all shipping costs for valid warranty claims⁶ ↪ Service upgrade options:⁷ <ul style="list-style-type: none"> • 3-year, on site exchange, Mon-Fri 9-5 with next day response (Lenovo CareSM part number 41K0554) ↪ Post-warranty maintenance services:¹¹ <ul style="list-style-type: none"> • 1-year, maintenance on site exchange, Mon-Fri 9-5 with next day response (Lenovo Care part number 41K0555) ↪ 24x7⁸ day toll-free support for warranty issues during the warranty period⁴ 	<p>Accessories</p> <p>ThinkPad[®] Convertible Monitor Stand 40Y7620 ThinkVision[®] TFT Radial Arm⁹ 19K4464</p> <p>See details at www.lenovo.com/support/monitoraccessories</p> <p>See all monitors at www.lenovo.com/thinkvision</p>	

See footnotes for important warranty information
 US model announced November 21, 2006

Flat Panel Monitors - US model	Features										
<p>Name L220x Wide Flat Panel Monitor Case color Business black Type-model 4433-HB2 Stand Tilt, swivel, pivot, and height adjustable stand Screen LCD Active Matrix TFT (Thin Film Transistor) Viewable image size (diag) 22.0" / 559mm (diagonal) Aspect ratio 16:10 Pixel pitch (mm) .247mm Max view area (inches) 18.7" x 11.65" (horizontal x vertical) Max view area (mm) 473.76mm x 296.1mm (horizontal x vertical) Viewing angle at 10:1 CR 178° (+/- 89°) vertical, 178° (+/- 89°) horizontal Video input Digital or analog (two separate connectors) Dual input Dual input (two different PCs attach to two different connectors; one PC shows image; select via button) Rotating screen Screen pivots 90 degrees from landscape to portrait (requires image rotation support from graphics controller), auto-rotation without software USB hub USB 2.0 Hub (1 port into PC, 4 ports for accessories)</p>	<ul style="list-style-type: none"> • Widescreen 22-inch flat panel monitor • EPEAT™ Gold rating • Supports WUXGA 1920x1200 resolution • High Definition (HD) ready; supports 1080p video • Uses Super Patterned Vertical Alignment (SPVA) for high contrast images with a broader range of the color spectrum • Slim 17.0mm (0.67") side bezel • High-bandwidth Digital Content Protection (HDCP)-compliant • USB hub (four powered ports) • Ergonomic stand tilts, swivels, pivots and provides a 110mm range height adjustment for comfortable viewing • Quick and easy monitor adjustments with on-screen-display via OnScreen Manager™ (soft OSM™) • Includes dual input connection for attachment to two systems concurrently (analog and digital) • Rear stand cover and clip to hide cables • Complements the ThinkCentre® and ThinkPad® systems • Microsoft® Windows® Vista™ Premium certified 										
<p>Optimum resolution 1920x1200 at 60Hz with 92% color gamut Maximum resolution 1920x1200 at 60Hz (205MHz max pixel rate) Vertical frequency 50 to 75Hz Horizontal frequency 30 to 94kHz Preset display modes VGA: 640x480 60, 66, 72, 75Hz 640x350 70Hz 720x400 70Hz SVGA: 800x600 60, 72, 75Hz XGA: 1024x768 60, 70, 75Hz 1152x864 75Hz SXGA: 1280x1024 60, 72, 75 1440x900 60 (reduced blanking), 60, 75 UXGA: 1600x1200 60, 70, 75 WSXGA+: 1680x1050 60 (reduced blanking), 60 WUXGA: 1920x1200 60 (reduced blanking) Presets / user settings Standard presets: 25; user settings: 20 Brightness 325 nits or cd/m² (typical) Contrast ratio 1200:1 (typical) Pixel response time 6ms (typical) Color gamut 92%</p>	 <p>ThinkVision L220x Wide pivots from landscape to portrait</p>										
<p>On screen display (1) On screen display with digital user controls (7 languages) (2) EnTech Taiwan OnScreen Manager™ (soft OSM™) Control features Direct access (buttons on front) for automatic image setup Monitor connectors Two connectors: (1) analog VGA 15-pin D-shell [blue], (2) Digital Visual Interface (DVI-D) for digital (not analog) attach [white], HDCP-compliant Signal cables Two cables: (1) detachable, VGA 15-pin D-shell at each end (for analog connector), 3.0 meter, matches color of monitor (2) detachable digital, DVI-D at each end (for digital connector), 3.0 meter, matches color of monitor Anti-reflective Anti-reflective, anti-glare Dimensions 14.9"H min lift (19.2" max lift) x 20.1"W x 10.8"D / 377mm min lift (487mm max lift) H x 510mm W x 274mm D Weight 16.9 lb / 7.7kg Viewing adjustments Tilt: 30° back, 0° forward / lift: 4.3" (110mm) / swivel: +/-45° / detachable stand Mounting features Wall or desk mounting using the Radial Arm⁹ or third-party accessories meeting the VESA FPMPI® (100mm mount) Security Security keyhole for attachment of optional cable lock (Kensington® lock-compatible)</p>											
<p>VESA-compliant² VESA DDC2B/CI, VESA DPMS-compliant Power management ENERGY STAR® 4.0 Ergonomics ISO 13406 Part 2¹ Pixel defect ISO 13406-2 Class II pixel defect standard Emission standards MPR-2, MPR-3A, FCC Class B Environmental TCO 03, WEEE, RoHS (EU Directive 2002/95/EC), EPEAT™ Gold rating Ship group Monitor, attached stand, Setup poster, Safety and Warranty Information, CD with multilingual User's Guide and monitor installation files, analog signal cable, digital signal cable, 3 meter USB cable, 1.8m black power cord Power supply 100-240Vac (universal), integrated (no external brick-like power supply), 90 watts typical, <2 watts standby/suspend Limited warranty⁴ 3 year (includes backlight) Available date November 2007</p>											
<p style="text-align: center;">Limited Warranty</p> <ul style="list-style-type: none"> ↔ 3 year limited warranty⁴ ↔ International Warranty Service⁵ ↔ Rapid Replacement Service at 1-800-IBM-SERV (426-7378) ↔ Replacement normally arrives in two business days, excluding holidays ↔ Lenovo pays all shipping costs for valid warranty claims⁶ ↔ Service upgrade options:⁷ <ul style="list-style-type: none"> • 3 year, on site exchange, Mon-Fri 9-5 with next day response (ThinkPlus™ part number 41C9209) • 3 year, on site exchange, 7 day x 24 hr with 4 hour response (41C9212) • 4 year, on site exchange, Mon-Fri 9-5 with next day response (41C9233) • 4 year, on site exchange, 7 day x 24 hr with 4 hour response (41C9234) ↔ 24x7⁸ day toll-free support for warranty issues during the warranty period⁴ 	<p style="text-align: center;">Accessories</p> <table border="0"> <tr> <td>ThinkVision® USB Soundbar</td> <td>40Y7616</td> </tr> <tr> <td>Kensington® MicroSaver® Security Cable Lock</td> <td>73P2582</td> </tr> <tr> <td>Kensington Twin Head Cable Lock</td> <td>45K1620</td> </tr> <tr> <td>ThinkPad Convertible Monitor Stand</td> <td>40Y7620</td> </tr> <tr> <td>ThinkVision TFT Radial Arm⁹</td> <td>19K4464</td> </tr> </table> <p>See details at www.lenovo.com/support/monitoraccessories</p> <p>See all monitors at www.lenovo.com/thinkvision</p>	ThinkVision® USB Soundbar	40Y7616	Kensington® MicroSaver® Security Cable Lock	73P2582	Kensington Twin Head Cable Lock	45K1620	ThinkPad Convertible Monitor Stand	40Y7620	ThinkVision TFT Radial Arm ⁹	19K4464
ThinkVision® USB Soundbar	40Y7616										
Kensington® MicroSaver® Security Cable Lock	73P2582										
Kensington Twin Head Cable Lock	45K1620										
ThinkPad Convertible Monitor Stand	40Y7620										
ThinkVision TFT Radial Arm ⁹	19K4464										

See footnotes for important warranty information
 US model announced October 23, 2007

<p>Name L2240p Wide Flat Panel Monitor Case color Business black Type-model 4422-HB6 Panel TFT-LCD, twisted nematic (TN), CCFL backlight Viewable image size 22.0" (559mm) diagonal Max view area (W x H) 18.65" x 11.66" (473.8mm x 296.1mm) Optimum resolution 1680x1050 at 60Hz Maximum resolution 1680x1050 at 75Hz (190MHz max pixel rate) Aspect ratio 16:10 Pixel pitch (mm) .282mm Dot/Pixel per Inch 98 dpi Brightness 250 nits or cd/m² (typical) Contrast ratio 1000:1 (typical) Pixel response time 5ms (typical) Color gamut 72% Anti-reflective Anti-reflective, anti-glare Vertical frequency 50 to 75Hz Horizontal frequency 30 to 83kHz Viewing angle at 10:1 CR 160° (+/- 80°) horizontal, 160° (+/- 80°) vertical Stand Tilt, swivel, pivot, and height adjustable stand Bezel width Sides: 0.69" (17.5mm); top: 0.72" (18.3mm); bottom: 1.11" (28.3mm) Dimensions (HxWxD) 14.9-19.2" H x 20.1" W x 7.4-9.5" D; 378.8-488.8mm H x 510.3mm W x 188-241.1mm D Power supply 21 watts typical, 31 watts maximum, <1 watts standby/suspend, universal, integrated (no external brick-like power supply) Weight 14 lb; 6.35kg Limited warranty⁴ 3 year (includes backlight) Available date October 2008</p>	<p>Features</p> <ul style="list-style-type: none"> • Widescreen 22-inch monitor • Supports WSXGA+ 1680x1050 resolution • Ergonomic stand tilts, swivels, pivots and provides a 4.3" (110mm) range height adjustment for comfortable viewing • Detachable rear stand cable cover and clip to hide cables • Carrying handle • 65% recycled packaging materials • Microsoft® Windows® Vista® certified 										
<p>VESA-compliant² VESA DDC2B/CI, VESA DPMS-compliant Power management ENERGY STAR[®] 4.1 Tier 2 Ergonomics ISO 13406 Part 2¹ Pixel defect ISO 13406-2 Class II pixel defect standard Emission standards MPR-2, MPR-3A, FCC Class B Environmental TCO 03, WEEE, RoHS (EU Directive 2002/95/EC), EPEAT™ Gold rating, GREENGUARD® certified</p>	 <p>ThinkVision L2240p Wide Monitor</p>										
<p>Preset resolutions VGA: 640x350, 640x480, 720x400 SVGA: 800x600 XGA: 1024x768, 1152x864 SXGA: 1280x1024 WXGA+: 1440x900 UXGA: 1600x1000 WSXGA+: 1680x1050 Presets / user settings Standard presets: 22; user settings: 20</p>	<p>Viewing adjustments Tilt: 30° back, 0° forward; lift: 4.3" (110mm); swivel: +/-45°; detachable stand Rotating screen Screen pivots 90 degrees from landscape to portrait (requires image rotation support from graphics controller), On screen display On screen display with digital user controls (8 languages) Control features Direct access (buttons on front) for automatic image setup Multiple input Multiple input (two different PCs attach to two different connectors; one PC shows image; select via button) Monitor connectors (1) VGA 15-pin D-shell, analog, blue (2) Digital Visual Interface (DVI-D), digital, white, HDCP-compliant Signal cables (1) detachable, VGA 15-pin D-shell at each end, analog, 2.2 meter (2) detachable, DVI-D at each end, digital, 2.2 meter Mounting features Wall or desk mounting using the Radial Arm⁹ or third-party accessories meeting the VESA FPMPI[®] (100mm mount) Security Security keyhole for attachment of optional cable lock (Kensington® lock-compatible)</p>										
<p>Ship group Monitor, attached stand, cable cover, Setup poster, Safety and Warranty Information, CD with multilingual User's Guide and monitor installation files, 2.2 meter analog signal cable, 2.2 meter digital signal cable, 1.8 meter black power cord</p>	<p>Accessories</p> <table border="0"> <tr> <td>ThinkVision USB Soundbar</td> <td>40Y7616</td> </tr> <tr> <td>Kensington® Cable Lock from Lenovo</td> <td>73P2582</td> </tr> <tr> <td>Kensington Twin Head Cable Lock</td> <td>45K1620</td> </tr> <tr> <td>ThinkPad Convertible Monitor Stand</td> <td>40Y7620</td> </tr> <tr> <td>ThinkVision TFT Radial Arm⁹</td> <td>19K4464</td> </tr> </table> <p>See details at www.lenovo.com/support/monitoraccessories</p> <p>See all monitors at www.lenovo.com/thinkvision</p>	ThinkVision USB Soundbar	40Y7616	Kensington® Cable Lock from Lenovo	73P2582	Kensington Twin Head Cable Lock	45K1620	ThinkPad Convertible Monitor Stand	40Y7620	ThinkVision TFT Radial Arm ⁹	19K4464
ThinkVision USB Soundbar	40Y7616										
Kensington® Cable Lock from Lenovo	73P2582										
Kensington Twin Head Cable Lock	45K1620										
ThinkPad Convertible Monitor Stand	40Y7620										
ThinkVision TFT Radial Arm ⁹	19K4464										
<p>Limited Warranty</p> <ul style="list-style-type: none"> ⇒ 3 year limited warranty⁴ ⇒ International Warranty Service⁵ ⇒ Rapid Replacement Service at 1-800-IBM-SERV (426-7378) ⇒ Replacement normally arrives in two business days, excluding holidays ⇒ Lenovo pays all shipping costs for valid warranty claims⁶ ⇒ Service upgrade options:⁷ <ul style="list-style-type: none"> • 3 year, on site exchange, Mon-Fri 9-5 with next day response (ThinkPlus™ part number 41C9209) • 3 year, on site exchange, 7 day x 24 hr with 4 hour response (41C9212) • 4 year, on site exchange, Mon-Fri 9-5 with next day response (41C9233) • 4 year, on site exchange, 7 day x 24 hr with 4 hour response (41C9234) ⇒ 24x7⁸ day toll-free support for warranty issues during the warranty period⁴ 											

See footnotes for important warranty information
 US model announced September 17, 2008

<p>Name L2440p Wide Flat Panel Monitor Case color Business black Type-model 4420-HB2 Panel TFT-LCD, twisted nematic (TN), CCFL backlight Viewable image size 24.0" (610mm) diagonal Max view area (W x H) 20.4" x 12.8" (518.4mm x 324.0mm) Optimum resolution 1920x1200 at 60Hz Maximum resolution 1920x1200 at 60Hz (205MHz max pixel rate) Aspect ratio 16:10 Pixel pitch (mm) .270mm Dot/Pixel per Inch 94 dpi Brightness 300 nits or cd/m² (typical) Contrast ratio 1000:1 (typical) Pixel response time 5ms (typical) Color gamut 72% Anti-reflective Anti-reflective, anti-glare Vertical frequency 50 to 75Hz Horizontal frequency 30 to 94kHz Viewing angle at 10:1 CR 170° (+/- 85°) horizontal, 160° (+/- 80°) vertical Stand Tilt, swivel, pivot, and height adjustable stand Bezel width Sides: 0.78" (19.9mm); top: 0.78" (19.9mm); bottom: 1.12" (28.4mm) Dimensions (HxWxD) 15.54-19.87" H x 22" W x 8.04-10.13" D; 394.8-504.8mm H x 559.6mm W x 204.3-257.3mm D Power supply 35 watts typical, 50 watts maximum, <1 watts standby/suspend, universal, integrated (no external brick-like power supply) Weight 17.84 lb; 8.09kg Limited warranty⁴ 3 year (includes backlight) Available date October 2008</p>	<p>Features</p> <ul style="list-style-type: none"> • Widescreen 24-inch monitor • Supports WUXGA 1920x1200 resolution • High Definition (HD) ready; supports 1080p video • Ergonomic stand tilts, swivels, pivots and provides a 4.3" (110mm) range height adjustment for comfortable viewing • Detachable rear stand cable cover and clip to hide cables • Carrying handle • 65% recycled packaging materials • Microsoft® Windows® Vista® Premium certified
<p>VESA-compliant² VESA DDC2B/CI, VESA DPMS-compliant Power management ENERGY STAR[®] 4.1 Tier 2 Ergonomics ISO 13406 Part 2¹ Pixel defect ISO 13406-2 Class II pixel defect standard Emission standards MPR-2, MPR-3A, FCC Class B Environmental TCO 03, WEEE, RoHS (EU Directive 2002/95/EC), EPEAT™ Gold rating, GREENGUARD® certified</p>	 <p style="text-align: center;">ThinkVision L2440p Wide Monitor</p>
<p>Preset resolutions VGA: 640x350, 640x480, 720x400 SVGA: 800x600 XGA: 1024x768, 1152x864 SXGA: 1280x1024 WXGA: 1360x768 WXGA+: 1440x900 UXGA: 1600x1200 WSXGA+: 1680x1050 WUXGA: 1920x1200 Presets / user settings Standard presets: 27; user settings: 20</p>	
<p>Viewing adjustments Tilt: 30° back, 0° forward; lift: 4.3" (110mm); swivel: +/-45°; detachable stand Rotating screen Screen pivots 90 degrees from landscape to portrait (requires image rotation support from graphics controller), On screen display On screen display with digital user controls (8 languages) Control features Direct access (buttons on front) for automatic image setup USB hub USB 2.0 Hub (1 port into PC, 4 ports for accessories) Multiple input Multiple input (two different PCs attach to two different connectors; one PC shows image; select via button) Monitor connectors (1) VGA 15-pin D-shell, analog, blue (2) Digital Visual Interface (DVI-D), digital, white, HDCP-compliant Signal cables (1) detachable, VGA 15-pin D-shell at each end, analog, 2.2 meter (2) detachable, DVI-D at each end, digital, 2.2 meter Mounting features Wall or desk mounting using the Radial Arm⁹ or third-party accessories meeting the VESA FPMPI[®] (100mm mount) Security Security keyhole for attachment of optional cable lock (Kensington® lock-compatible)</p>	<p>Ship group Monitor, attached stand, cable cover, Setup poster, Safety and Warranty Information, CD with multilingual User's Guide and monitor installation files, 2.2 meter analog signal cable, 2.2 meter digital signal cable, 2.2 meter USB cable, 1.8 meter black power cord</p>

Limited Warranty
↪ 3 year limited warranty⁴
↪ International Warranty Service⁵
↪ Rapid Replacement Service at 1-800-IBM-SERV (426-7378)
↪ Replacement normally arrives in two business days, excluding holidays
↪ Lenovo pays all shipping costs for valid warranty claims⁶
↪ Service upgrade options:⁷
• 3 year, on site exchange, Mon-Fri 9-5 with next day response (ThinkPlus™ part number 41C9209)
• 3 year, on site exchange, 7 day x 24 hr with 4 hour response (41C9212)
• 4 year, on site exchange, Mon-Fri 9-5 with next day response (41C9233)
• 4 year, on site exchange, 7 day x 24 hr with 4 hour response (41C9234)
↪ 24x7⁸ day toll-free support for warranty issues during the warranty period⁴

Accessories	
ThinkVision Soundbar (L1900p, 24" Wide)	45K1263
Kensington® Cable Lock from Lenovo	73P2582
Kensington Twin Head Cable Lock	45K1620
ThinkPad Convertible Monitor Stand	40Y7620
ThinkVision TFT Radial Arm ⁹	19K4464
See details at www.lenovo.com/support/monitoraccessories	
See all monitors at www.lenovo.com/thinkvision	

See footnotes for important warranty information
 US model announced September 17, 2008

<p>Name L2440x Wide Flat Panel Monitor Case color Business black Type-model 4421-HB2 Panel TFT-LCD, twisted nematic (TN), white LED backlight Viewable image size 24.0" (610mm) diagonal Max view area (W x H) 20.4" x 12.8" / 518.4mm x 324.0mm Optimum resolution 1920x1200 at 60Hz Maximum resolution 1920x1200 at 60Hz (205MHz max pixel rate) Aspect ratio 16:10 Pixel pitch (mm) .270mm Dot/Pixel per Inch 94 dpi Brightness 300 nits or cd/m² (typical) Contrast ratio 1000:1 (typical) Pixel response time 5ms (typical) Color gamut 72% Anti-reflective Anti-reflective, anti-glare Vertical frequency 50 to 75Hz Horizontal frequency 30 to 94kHz Viewing angle at 10:1 CR 170° (+/- 85°) horizontal, 160° (+/- 80°) vertical Stand Tilt, swivel, pivot, and height adjustable stand Bezel width <i>Sides:</i> 0.78" (19.9mm); <i>top:</i> 0.78" (19.9mm); <i>bottom:</i> 1.12" (28.4mm) Dimensions (HxWxD) 15.54-19.87" H x 22" W x 8.04-10.13" D; 394.8-504.8mm H x 559.6mm W x 204.3-257.3mm D Power supply 29 watts typical, 45 watts maximum, <1 watts standby/suspend, universal, integrated (no external brick-like power supply) Weight 17.16 lb; 7.78kg Limited warranty⁴ 3 year (includes backlight) Available date October 2008</p>	<p>Features</p> <ul style="list-style-type: none"> • Widescreen 24-inch monitor with white LED backlight • Supports WUXGA 1920x1200 resolution • High Definition (HD) ready; supports 1080p video • Ergonomic stand tilts, swivels, pivots and provides a 4.3" (110mm) range height adjustment for comfortable viewing • Detachable rear stand cable cover and clip to hide cables • Carrying handle • Mercury and arsenic free • Low halogen with trace levels of BFR, CFR, and PVC ¹² • 65% recycled packaging materials • Microsoft® Windows® Vista® Premium certified
<p>VESA-compliant² VESA DDC2B/CI, VESA DPMS-compliant Power management ENERGY STAR^{®3} 4.1 Tier 2 Ergonomics ISO 13406 Part 2¹ Pixel defect ISO 13406-2 Class II pixel defect standard Emission standards MPR-2, MPR-3A, FCC Class B Environmental TCO 03, WEEE, RoHS (EU Directive 2002/95/EC), EPEAT™ Gold rating, GREENGUARD[®] certified</p>	 <p style="text-align: center;">ThinkVision L2440x Wide Monitor</p>
<p>Preset resolutions VGA: 640x350, 640x480, 720x400 SVGA: 800x600 XGA: 1024x768, 1152x864 SXGA: 1280x1024 WXGA: 1360x768 WXGA+: 1440x900 UXGA: 1600x1200 WSXGA+: 1680x1050 WUXGA: 1920x1200 Presets / user settings Standard presets: 27; user settings: 20</p>	
<p>Viewing adjustments <i>Tilt:</i> 30° back, 0° forward; <i>lift:</i> 4.3" (110mm); <i>swivel:</i> +/-45°; detachable stand Rotating screen Screen pivots 90 degrees from landscape to portrait (requires image rotation support from graphics controller) On screen display On screen display with digital user controls (8 languages) Control features Direct access (buttons on front) for automatic image setup USB hub USB 2.0 Hub (1 port into PC, 4 ports for accessories) Multiple input Multiple input (three different PCs attach to three different connectors; one PC shows image; select via button) Monitor connectors (1) VGA 15-pin D-shell, analog, blue (2) Digital Visual Interface (DVI-D), digital, white, HDCP-compliant (3) DisplayPort, digital, black, HDCP-compliant Signal cables (1) detachable, VGA 15-pin D-shell at each end, analog, 2.2 meter (2) detachable, DVI-D at each end, digital, 2.2 meter (3) detachable, DisplayPort at each end, digital, 2.2 meter Mounting features Wall or desk mounting using the Radial Arm⁹ or third-party accessories meeting the VESA FPMPI[®] (100mm mount) Security Security keyhole for attachment of optional cable lock (Kensington[®] lock-compatible)</p>	<p>Viewing adjustments <i>Tilt:</i> 30° back, 0° forward; <i>lift:</i> 4.3" (110mm); <i>swivel:</i> +/-45°; detachable stand Rotating screen Screen pivots 90 degrees from landscape to portrait (requires image rotation support from graphics controller) On screen display On screen display with digital user controls (8 languages) Control features Direct access (buttons on front) for automatic image setup USB hub USB 2.0 Hub (1 port into PC, 4 ports for accessories) Multiple input Multiple input (three different PCs attach to three different connectors; one PC shows image; select via button) Monitor connectors (1) VGA 15-pin D-shell, analog, blue (2) Digital Visual Interface (DVI-D), digital, white, HDCP-compliant (3) DisplayPort, digital, black, HDCP-compliant Signal cables (1) detachable, VGA 15-pin D-shell at each end, analog, 2.2 meter (2) detachable, DVI-D at each end, digital, 2.2 meter (3) detachable, DisplayPort at each end, digital, 2.2 meter Mounting features Wall or desk mounting using the Radial Arm⁹ or third-party accessories meeting the VESA FPMPI[®] (100mm mount) Security Security keyhole for attachment of optional cable lock (Kensington[®] lock-compatible)</p>
<p>Ship group Monitor, attached stand, cable cover, Setup poster, Safety and Warranty Information, CD with multilingual User's Guide and monitor installation files, 2.2 meter analog signal cable, 2.2 meter digital signal cable, 2.2 meter DisplayPort cable, 2.2 meter USB cable, 1.8 meter black power cord</p>	

<p style="text-align: center;">Limited Warranty</p> <ul style="list-style-type: none"> ↪ 3 year limited warranty⁴ ↪ International Warranty Service⁵ ↪ Rapid Replacement Service at 1-800-IBM-SERV (426-7378) ↪ Replacement normally arrives in two business days, excluding holidays ↪ Lenovo pays all shipping costs for valid warranty claims⁶ ↪ Service upgrade options:⁷ <ul style="list-style-type: none"> • 3 year, on site exchange, Mon-Fri 9-5 with next day response (ThinkPlus™ part number 41C9209) • 3 year, on site exchange, 7 day x 24 hr with 4 hour response (41C9212) • 4 year, on site exchange, Mon-Fri 9-5 with next day response (41C9233) • 4 year, on site exchange, 7 day x 24 hr with 4 hour response (41C9234) ↪ 24x7⁸ day toll-free support for warranty issues during the warranty period⁴ 	<p style="text-align: center;">Accessories</p> <table border="0"> <tr> <td>ThinkVision Soundbar (L1900p, 24" Wide)</td> <td style="text-align: right;">45K1263</td> </tr> <tr> <td>Kensington[®] Cable Lock from Lenovo</td> <td style="text-align: right;">73P2582</td> </tr> <tr> <td>Kensington Twin Head Cable Lock</td> <td style="text-align: right;">45K1620</td> </tr> <tr> <td>ThinkPad Convertible Monitor Stand</td> <td style="text-align: right;">40Y7620</td> </tr> <tr> <td>ThinkVision TFT Radial Arm⁹</td> <td style="text-align: right;">19K4464</td> </tr> </table> <p>See details at www.lenovo.com/support/monitoraccessories</p> <p>See all monitors at www.lenovo.com/thinkvision</p>	ThinkVision Soundbar (L1900p, 24" Wide)	45K1263	Kensington [®] Cable Lock from Lenovo	73P2582	Kensington Twin Head Cable Lock	45K1620	ThinkPad Convertible Monitor Stand	40Y7620	ThinkVision TFT Radial Arm ⁹	19K4464
ThinkVision Soundbar (L1900p, 24" Wide)	45K1263										
Kensington [®] Cable Lock from Lenovo	73P2582										
Kensington Twin Head Cable Lock	45K1620										
ThinkPad Convertible Monitor Stand	40Y7620										
ThinkVision TFT Radial Arm ⁹	19K4464										

See footnotes for important warranty information
 US model announced September 17, 2008

Availability: All offers subject to availability. Lenovo reserves the right to alter product offerings and specifications at any time, without notice. Lenovo is not responsible for photographic or typographic errors.

Warranty: For a copy of applicable product warranties, write to: Warranty Information, P.O. Box 12195, RTP, NC, 27709, Attn: Dept ZPYA/B676. Lenovo makes no representation or warranty regarding third party products or services.

- ¹ **ISO-compliant:** Compliance with ISO 9241 Part 3, ISO Part 7, ISO Part 8, and/or ISO 13406 Part 2 is dependent on a complete ISO-capable platform of a system unit, monitor, video subsystem, operating system and fonts.
- ² **VESA:** Requires attachment to suitably configured system with similarly enabled operating system.
- ³ **ENERGY STAR:** As an ENERGY STAR partner, Lenovo has determined that this product meets the ENERGY STAR 4.0 or 4.1 guidelines for energy efficiency. Requires attachment to suitably configured system.
- ⁴ **Limited warranty:** Support unrelated to a warranty issue may be subject to additional charges.
- ⁵ **International Warranty Service** is available in any country in which this product is sold and serviced. Service delivery methods and parts availability vary by country, may be different from that in the country of purchase, and are subject to change without notice. Fees and restrictions may apply in some countries.
- ⁶ **Lenovo pays all shipping costs** for warranty repairs during limited warranty period.
- ⁷ **ThinkPlus and Lenovo Care Services:** These services are available for machines normally used for business, professional, or trade purposes, rather than personal, family, or household purposes. Not all machine types and models are covered. Service period begins with the equipment date of purchase. Service must be purchased during the original limited product warranty period. Service levels are response time objectives and are not guarantees. If the machine problem turns out to be a Customer Replaceable Unit (CRU), a part will be express shipped to you for quick replacement. Onsite 24x7x2-hour service is not available in all locations. P&L means parts and labor. P/U means pick-up. See terms and conditions for complete details and restrictions.
- ⁸ **Telephone support** may be subject to additional charges, even during the limited warranty period. In the United States call 1-800-426-7378. Response times may vary. May exclude some holidays. If a machine is listed as having "On-site service for select repairs", this means that onsite service is available only for the replacement of select parts. For all other warranty repairs, Lenovo will provide the customer a replacement part for customer installation. The parts for which onsite service is available varies by machine, but may include the processor, power supply, heat sink, system board, or base cover. For machines with EasyServ or Courier service, Lenovo will attempt to diagnose and resolve the problem remotely before sending a courier.
- ⁹ **Radial Arm Kit:** Designed for business environment; radial arm must be installed in accordance with instructions provided.
- ¹⁰ **TAA:** Monitor is compliant with the U.S. Federal Government's country-of-origin requirements prescribed in 48 C.F.R. Subpart 25.4; Trade Act Agreement (TAA) model.
- ¹¹ **Post-warranty annual maintenance agreement:** Service begins at the end of the base warranty or the end of any other applied warranty and maintenance option, whichever occurs last. Service delivery is not available the same day the maintenance agreement is purchased. Maintenance agreements must be purchased and the registration successfully completed prior to the service being available.
- ¹² **Halogen:** Less than 900 Parts Per Million. Low halogen is defined in accordance with IPC-401B and draft IPC-J-STD 709 Class 1 requirements.

ThinkVision®

Trademarks: Lenovo, the Lenovo logo, New World. New Thinking., Access Connections, Rescue and Recovery, ThinkCentre, ThinkPad, ThinkStation, ThinkVantage, and ThinkVision are trademarks of Lenovo. Microsoft, Windows, and Vista are registered trademarks of Microsoft Corporation. Other company, product, or service names may be trademarks or service marks of others.

This publication was developed for products and services offered in the United States. Lenovo may not offer the products, services or features discussed in this document in other countries. Lenovo may withdraw an offering at any time. Information is subject to change without notice. Consult your local representative for information on offerings available in your area.

Lenovo reserves the right to alter specifications and other product information at any time without prior notice. Lenovo is not responsible for photographic or typographical errors. **LENOVO PROVIDES THIS PUBLICATION "AS IS" WITHOUT WARRANTY OF ANY KIND, EITHER EXPRESS OR IMPLIED, INCLUDING THE IMPLIED WARRANTIES OF MERCHANTABILITY OR FITNESS FOR A PARTICULAR PURPOSE.** Some jurisdictions do not allow disclaimer of express or implied warranties in certain transactions; therefore this disclaimer may not apply to you. This publication was developed in the US.

Visit lenovo.com/safecomputing periodically for the latest information on safe and effective computing

© Lenovo, 2008.
All rights reserved.

Lenovo
1009 Think Place
Morrisville, NC 27560
U.S.A.

December 2008
mbook.pdf



Personal Systems Reference Lenovo® IdeaPad™ Netbooks and Notebooks

January 2009 - Version 350



Lenovo IdeaPad S10e

Visit www.lenovo.com/psref for the latest version



Lenovo IdeaPad S9e



Lenovo IdeaPad S9e



Lenovo IdeaPad S10e

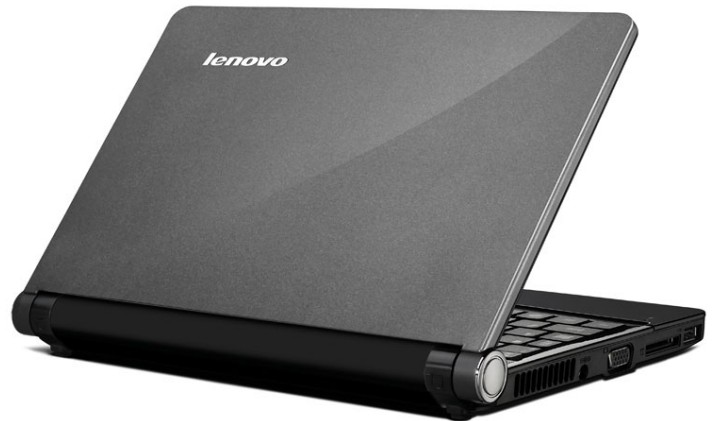

Lenovo IdeaPad S10e



Lenovo IdeaPad S10e



Lenovo IdeaPad S10e

Type-model	Processor	GHz	Memory	Widescreen display	Camera	Integrated graphics	Disk	Mini PCIe 802.11 wireless	Color	Blue-tooth	Battery	Preload	Avail date
4187-34U	Atom N270	1.60	512MB	8.9" WSVGA	Cam	GMA	80GB ² HDD	11b/g ¹¹	Gray		3-cell	XP Home	Nov 08
4187-33U	Atom N270	1.60	1GB	8.9" WSVGA	Cam	GMA	80GB HDD	11b/g	Gray	Blue	6-cell	XP Home	Dec 08

- **Lenovo's netbook: smaller and lighter than a notebook**
- **8.9" widescreen display with LED backlight**
- **Super-slim (starting at 0.9 inches thin), ultra-light (starting at 2.43 pounds)**
- **ExpressCard slot for WWAN card**
- **Touch pad supports multi-touch function (pinch, expansion, chiral motion)**
- **Integrated camera**
- **Lenovo Quick Start: Utility for quick access to Web, music, photos, chat, and Skype® without booting Windows**

Positioning	<i>Netbook; consumer markets</i>		Preloaded operating system²⁰	
Processor	Intel® Atom™ Processor N270 with single-core, Hyper-Threading technology, 533MHz system bus, and 512KB L2 cache		- Microsoft® Windows® XP Home Edition	
Memory	512MB or 1GB std / 1.5GB max ⁷ / PC2-5300 667MHz DDR2 , non-parity, single-channel, one 200-pin SO-DIMM socket; <i>Italics:</i> standard memory 512MB soldered to systemboard, 512MB in socket; no sockets available; <i>Non-italics:</i> standard memory 512MB soldered to systemboard; one socket available		Preloaded applications¹⁴	
External combo SATA disk	None 80GB (5400 rpm) HDD / SATA 1.5Gb/s, 9.5mm high, 2.5" wide, not removable		• ThinkVantage® System Update	
Widescreen display	8.9" (226.1mm) WSVGA (1024x600) TFT color, LED backlight , 180 nits, 16:10 aspect ratio, 300:1 contrast ratio		• Norton Internet Security™ (90 days of virus definitions)	
Camera	Camera on top of screen, 0.3-megapixel, fixed focus		• PC-Doctor™ (diagnostics) (HDD models)	
Graphics	Intel Graphics Media Accelerator 950 (GMA 950) , in 945GSE		• Adobe® Reader® (HDD models)	
Keyboard	6-row, 80-key, 85% size, Fn keys, Novo key, wireless on/off button		• Adobe Flash® Player	
Touch pad	Two-button touch pad with scroll feature (no TrackPoint®), multi-touch		• Windows Live™ Toolbar	
Dimensions ³	<i>3-cell:</i> (WxDxH): 9.8" x 7.2" x 0.9-1.1"; 250mm x 183mm x 22-27.5mm <i>6-cell:</i> (WxDxH): 9.8" x 7.7" x 0.9-1.4"; 250mm x 196mm x 22-36mm		• Microsoft Office 2007 Trial (60-day) (HDD models)	
Weight ²	<i>3-cell with HDD:</i> starting at 2.65 lb (1.2kg) <i>6-cell with HDD:</i> starting at 2.87 lb (1.3kg)			
Case color	<i>Top:</i> dark gray <i>Bottom:</i> dark gray			
Case material	Polycarbonate/Acrylonitrile-Butadiene-Styrene (PC/ABS) plastic			
Battery - type	Lithium Ion, 3-cell 2600 mAh or 6-cell 4800 mAh			
Battery - life ¹⁰	<i>3-cell:</i> up to 2.5 hr; <i>6-cell:</i> up to 5.0 hr			
Chipset	Mobile Intel 945GSE Express Chipset (Graphics Memory Controller Hub), ICH7M I/O Controller Hub (SATA 1.5Gb/s, USB 2.0, PCI Express® 1.1, PCI 2.3, ethernet MAC)			
ExpressCard/34	One slot (ExpressCard/34)		40-watt AC adapter	
Multicard reader	4-in-1 reader (MMC, Memory Stick®, Memory Stick PRO™, Secure Digital Card)		ENERGY STAR® 4.0-compliant	
Ports	Two USB 2.0, external monitor (VGA DB-15), ethernet (RJ-45)		RoHS-compliant	
TV tuner	None		Limited Warranty¹²	
Mini PCI Express	One Mini PCI Express slot		↪ Split warranty:	
11b/g ²⁸	11b/g wireless ⁴ , Mini PCIe adapter, Broadcom® BCM4312		1-year for display, disk, systemboard;	
Bluetooth™	<i>Some:</i> Bluetooth 2.1 wireless, LED indicator		90-day for other parts	
Modem	None		↪ EasyServ™ depot repair service¹⁹	
Ethernet	10/100 ethernet, Broadcom® BCM5906, PCI 2.3		↪ International Warranty Service¹⁷	
Audio support	High Definition (HD) Audio, RealTek® ALC269 codec / two stereo speakers (1.5 watt) / stereo microphone, microphone input jack (3.5 mm), stereo headphone jack (3.5 mm)		↪ 24x7¹⁶ toll-free support for warranty issues during the warranty period¹² via 800-426-7378	
Security	Power-on password, supervisor password, security keyhole			
Fingerprint reader	None			

See footnotes for important warranty information
US models announced November 25 or December 9, 2008

© Lenovo
(KRL1-1) January 2009

Type-model	Processor	GHz	Memory	Widescreen display	Camera	Integrated graphics	Disk	Mini PCIe 802.11 wireless	Color	Blue-tooth	Battery	Preload	Avail date
4187-32U	Atom N270	1.60	512MB	8.9" WSVGA	Cam	GMA	4GB ² SSD	11b/g ¹¹	Gray	None	3-cell	SLED10	Nov 08
4187-DRU	Atom N270	1.60	1GB	8.9" WSVGA	Cam	GMA	4GB SSD	11b/g	Gray	None	6-cell	SLED10	Dec 08

- **Lenovo's netbook: smaller and lighter than a notebook**
- **8.9" widescreen display with LED backlight**
- **Super-slim (starting at 0.9 inches thin), ultra-light (starting at 2.43 pounds)**
- **ExpressCard slot for WWAN card**
- **Touch pad supports multi-touch function (pinch, expansion, chiral motion)**
- **Integrated camera**

Positioning	<i>Netbook; consumer markets</i>							Preloaded operating system²⁰					
Processor	Intel® Atom™ Processor N270 with single-core, Hyper-Threading technology, 533MHz system bus, and 512KB L2 cache							- SUSE® Linux™ Enterprise Desktop10 Service Pack 2					
Memory	512MB or 1GB std / 1.5GB max ⁷ / PC2-5300 667MHz DDR2, non-parity, single-channel, one 200-pin SO-DIMM socket; <i>Italics:</i> standard memory 512MB soldered to systemboard, 512MB in socket; no sockets available; <i>Non-italics:</i> standard memory 512MB soldered to systemboard; one socket available							Preloaded applications ¹⁴					
External combo EIDE disk	None 4GB Solid State Drive (SSD) / EIDE, not removable							• Firefox® Web Browser					
Widescreen display	8.9" (226.1mm) WSVGA (1024x600) TFT color, LED backlight, 180 nits, 16:10 aspect ratio, 300:1 contrast ratio							• OpenOffice					
Camera	Camera on top of screen, 0.3-megapixel, fixed focus							• Evolution® email client					
Graphics	Intel Graphics Media Accelerator 950 (GMA 950), in 945GSE							• Pidgin instant messaging client					
Keyboard	6-row, 80-key, 85% size, Fn keys, Novo key, wireless on/off button							• Network Manager					
Touch pad	Two-button touch pad with scroll feature (no TrackPoint®), multi-touch							• GNOME™ Power Manager					
Dimensions ³	3-cell: (WxDxH): 9.8" x 7.2" x 0.9-1.1"; 250mm x 183mm x 22-27.5mm 6-cell: (WxDxH): 9.8" x 7.7" x 0.9-1.4"; 250mm x 196mm x 22-36mm							• AppArmor® Firewall					
Weight ²	3-cell with SSD: starting at 2.43 lb (1.1kg) 6-cell with SSD: starting at 2.65 lb (1.2kg)							• F-Spot photo software					
Case color	Top: dark gray Bottom: dark gray							• GIMP image editor					
Case material	Polycarbonate/Acrylonitrile-Butadiene-Styrene (PC/ABS) plastic							• Banshee® music player					
Battery - type	Lithium Ion, 3-cell 2600 mAh or 6-cell 4800 mAh							• RealPlayer®					
Battery - life ¹⁰	3-cell: up to 2.5 hr; 6-cell: up to 5.0 hr							• ClamAV™					
Chipset	Mobile Intel 945GSE Express Chipset (Graphics Memory Controller Hub), ICH7M I/O Controller Hub (SATA 1.5Gb/s, USB 2.0, PCI Express® 1.1, PCI 2.3, ethernet MAC)							• Adobe® Reader®					
ExpressCard/34	One slot (ExpressCard/34)							• System Backup Utility					
Multicard reader	4-in-1 reader (MMC, Memory Stick®, Memory Stick PRO™, Secure Digital Card)							40-watt AC adapter					
Ports	Two USB 2.0, external monitor (VGA DB-15), ethernet (RJ-45)							RoHS-compliant					
TV tuner	None							Limited Warranty¹²					
Mini PCI Express	One Mini PCI Express slot												
11b/g ²⁸	11b/g wireless ⁴ , Mini PCIe adapter, Broadcom® BCM4312												
Bluetooth™	None												
Modem	None												
Ethernet	10/100 ethernet, Broadcom® BCM5906, PCI 2.3												
Audio support	High Definition (HD) Audio, RealTek® ALC269 codec / two stereo speakers (1.5 watt) / stereo microphone, microphone input jack (3.5 mm), stereo headphone jack (3.5 mm)												
Security	Power-on password, supervisor password, security keyhole												
Fingerprint reader	None												

See footnotes for important warranty information
US models announced November 25 or December 9, 2008

© Lenovo
(KRL1-2) January 2009

Type-model	Processor	GHz	Memory	Widescreen display	Camera	Integrated graphics	Disk	Mini PCIe 802.11 wireless	Color	Blue-tooth	Battery	Preload	Avail date
4187-39U	Atom N270	1.60	512MB	10.1" WSVGA	Cam	GMA	80GB ² HDD	11b/g ¹¹	Gray		3-cell	XP Home	Nov 08
4187-3AU	Atom N270	1.60	1GB	10.1" WSVGA	Cam	GMA	80GB HDD	11b/g	Gray	Blue	6-cell	XP Home	Dec 08

- **Lenovo's netbook: smaller and lighter than a notebook**
- **10.1" widescreen display with LED backlight**
- **Super-slim (starting at 0.9 inches thin), ultra-light (starting at 2.43 pounds)**
- **ExpressCard slot for WWAN card**
- **Touch pad supports multi-touch function (pinch, expansion, chiral motion)**
- **Integrated camera**
- **Lenovo Quick Start: Utility for quick access to Web, music, photos, chat, and Skype® without booting Windows**

Positioning	<i>Netbook; consumer markets</i>							Preloaded operating system²⁰					
Processor	Intel® Atom™ Processor N270 with single-core, Hyper-Threading technology, 533MHz system bus, and 512KB L2 cache							- Microsoft® Windows® XP Home Edition					
Memory	512MB or 1GB std / 1.5GB max ⁷ / PC2-5300 667MHz DDR2, non-parity, single-channel, one 200-pin SO-DIMM socket; <i>Italics:</i> standard memory 512MB soldered to systemboard, 512MB in socket; no sockets available; <i>Non-italics:</i> standard memory 512MB soldered to systemboard; one socket available							Preloaded applications¹⁴					
External combo SATA disk	None 80GB (5400 rpm) HDD / SATA 1.5Gb/s, 9.5mm high, 2.5" wide, not removable							• ThinkVantage® System Update					
Widescreen display	10.1" (256.5mm) WSVGA (1024x576) TFT color, LED backlight, 200 nits, 16:9 aspect ratio, 300:1 contrast ratio							• Norton Internet Security™ (90 days of virus definitions)					
Camera	Camera on top of screen, 1.3-megapixel, fixed focus							• PC-Doctor™ (diagnostics) (HDD models)					
Graphics	Intel Graphics Media Accelerator 950 (GMA 950), in 945GSE							• Adobe® Reader® (HDD models)					
Keyboard	6-row, 80-key, 85% size, Fn keys, Novo key, wireless on/off button							• Adobe Flash® Player					
Touch pad	Two-button touch pad with scroll feature (no TrackPoint®), multi-touch							• Windows Live™ Toolbar					
Dimensions ³	3-cell: (WxDxH): 9.8" x 7.2" x 0.9-1.1"; 250mm x 183mm x 22-27.5mm 6-cell: (WxDxH): 9.8" x 7.7" x 0.9-1.4"; 250mm x 196mm x 22-36mm							• Microsoft Office 2007 Trial (60-day) (HDD models)					
Weight ²	3-cell: starting at 2.65 lb (1.2 kg) 6-cell: starting at 3.09 lb (1.4 kg)												
Case color	Top: dark gray Bottom: dark gray												
Case material	Polycarbonate/Acrylonitrile-Butadiene-Styrene (PC/ABS) plastic												
Battery - type	Lithium Ion, 3-cell 2600 mAh or 6-cell 4800 mAh												
Battery - life ¹⁰	3-cell: up to 2.5 hr; 6-cell: up to 5.0 hr												
Chipset	Mobile Intel 945GSE Express Chipset (Graphics Memory Controller Hub), ICH7M I/O Controller Hub (SATA 1.5Gb/s, USB 2.0, PCI Express® 1.1, PCI 2.3, ethernet MAC)												
ExpressCard/34	One slot (ExpressCard/34)							40-watt AC adapter					
Multicard reader	4-in-1 reader (MMC, Memory Stick®, Memory Stick PRO™, Secure Digital Card)							ENERGY STAR® 4.0-compliant					
Ports	Two USB 2.0, external monitor (VGA DB-15), ethernet (RJ-45)							RoHS-compliant					
TV tuner	None							Limited Warranty¹²					
Mini PCI Express	One Mini PCI Express slot							↪ Split warranty:					
11b/g ²⁸	11b/g wireless ⁴ , Mini PCIe adapter, Broadcom® BCM4312							1-year for display, disk, systemboard;					
Bluetooth™	Some: Bluetooth 2.1 wireless, LED indicator							90-day for other parts					
Modem	None							↪ EasyServ™ depot repair service¹⁹					
Ethernet	10/100 ethernet, Broadcom® BCM5906, PCI 2.3							↪ International Warranty Service¹⁷					
Audio support	High Definition (HD) Audio, RealTek® ALC269 codec / two stereo speakers (1.5 watt) / stereo microphone, microphone input jack (3.5 mm), stereo headphone jack (3.5 mm)							↪ 24x7¹⁶ toll-free support for warranty issues during the warranty period¹² via 800-426-7378					
Security	Power-on password, supervisor password, security keyhole												
Fingerprint reader	None												

See footnotes for important warranty information
US models announced November 25 or December 9, 2008

© Lenovo
(KRL1-5) January 2009

Type-model	Processor	GHz	Memory	Widescreen display	Camera	Integrated graphics	Disk	Mini PCIe 802.11 wireless	Color	Blue-tooth	Battery	Preload	Avail date
4187-ERU	Atom N270	1.60	1GB	10.1" WSVGA	Cam	GMA	4GB ² SSD	11b/g ¹¹	Gray	None	6-cell	SLED10	Dec 08

- **Lenovo's netbook: smaller and lighter than a notebook**
- **10.1" widescreen display with LED backlight**
- **Super-slim (starting at 0.9 inches thin), ultra-light (starting at 2.43 pounds)**
- **ExpressCard slot for WWAN card**
- **Touch pad supports multi-touch function (pinch, expansion, chiral motion)**
- **Integrated camera**

Positioning	<i>Netbook; consumer markets</i>							Preloaded operating system²⁰					
Processor	Intel® Atom™ Processor N270 with single-core, Hyper-Threading technology, 533MHz system bus, and 512KB L2 cache							- SUSE® Linux™ Enterprise Desktop10 Service Pack 2					
Memory	1GB std / 1.5GB max ⁷ / PC2-5300 667MHz DDR2, non-parity, single-channel, one 200-pin SO-DIMM socket; <i>Italics:</i> standard memory 512MB soldered to systemboard, 512MB in socket; no sockets available							Preloaded applications ¹⁴					
External combo EIDE disk	None 4GB Solid State Drive (SSD) / EIDE, not removable							• Firefox® Web Browser					
Widescreen display	10.1" (256.5mm) WSVGA (1024x576) TFT color, LED backlight, 200 nits, 16:9 aspect ratio, 300:1 contrast ratio							• OpenOffice					
Camera	Camera on top of screen, 1.3-megapixel, fixed focus							• Evolution® email client					
Graphics	Intel Graphics Media Accelerator 950 (GMA 950), in 945GSE							• Pidgin instant messaging client					
Keyboard	6-row, 80-key, 85% size, Fn keys, Novo key, wireless on/off button							• Network Manager					
Touch pad	Two-button touch pad with scroll feature (no TrackPoint®), multi-touch							• GNOME™ Power Manager					
Dimensions ³	3-cell: (WxDxH): 9.8" x 7.2" x 0.9-1.1"; 250mm x 183mm x 22-27.5mm 6-cell: (WxDxH): 9.8" x 7.7" x 0.9-1.4"; 250mm x 196mm x 22-36mm							• AppArmor® Firewall					
Weight ²	3-cell with SSD: starting at 2.43 lb (1.1kg) 6-cell with SSD: starting at 2.87 lb (1.3kg)							• F-Spot photo software					
Case color	Top: dark gray Bottom: dark gray							• GIMP image editor					
Case material	Polycarbonate/Acrylonitrile-Butadiene-Styrene (PC/ABS) plastic							• Banshee® music player					
Battery - type	Lithium Ion, 3-cell 2600 mAH or 6-cell 4800 mAH							• RealPlayer®					
Battery - life ¹⁰	3-cell: up to 2.5 hr; 6-cell: up to 5.0 hr							• ClamAV™					
Chipset	Mobile Intel 945GSE Express Chipset (Graphics Memory Controller Hub), ICH7M I/O Controller Hub (SATA 1.5Gb/s, USB 2.0, PCI Express® 1.1, PCI 2.3, ethernet MAC)							• Adobe® Reader®					
ExpressCard/34	One slot (ExpressCard/34)							• System Backup Utility					
Multicard reader	4-in-1 reader (MMC, Memory Stick®, Memory Stick PRO™, Secure Digital Card)												
Ports	Two USB 2.0, external monitor (VGA DB-15), ethernet (RJ-45)							40-watt AC adapter RoHS-compliant					
TV tuner	None							Limited Warranty¹²					
Mini PCI Express	One Mini PCI Express slot												
11b/g ²⁸	11b/g wireless ⁴ , Mini PCIe adapter, Broadcom® BCM4312												
Bluetooth™	None												
Modem	None												
Ethernet	10/100 ethernet, Broadcom® BCM5906, PCI 2.3												
Audio support	High Definition (HD) Audio, RealTek® ALC269 codec / two stereo speakers (1.5 watt) / stereo microphone, microphone input jack (3.5 mm), stereo headphone jack (3.5 mm)												
Security	Power-on password, supervisor password, security keyhole												
Fingerprint reader	None												

See footnotes for important warranty information
US model announced December 9, 2008

© Lenovo
(KRL1-6) January 2009

**Partial list of accessories supported on:
IdeaPad S9e and S10e****Memory**

512 MB PC2-5300 DDR2 SODIMM	40Y7733	ann 01/05/06
1 GB PC2-5300 DDR2 SODIMM	40Y7734	ann 01/05/06

Storage and removable storage

USB 2.0 Essential Memory Key 2GB	41U4944	ann 01/23/07
USB 2.0 Essential Memory Key 4GB	45J7904	ann 06/24/08
USB 2.0 Essential Memory Key 8GB	45J7905	ann 07/15/08
USB 2.0 CD-RW/DVD-ROM Combo II Drive	40Y8637	ann 01/05/06
USB 2.0 Super Multi-Burner Drive	41N5565	ann 01/23/07

Expansion

USB 2.0 Lenovo Enhanced Port Replicator	43R8770	ann 02/26/08
---	---------	--------------

Mouse

Lenovo Wireless Laser Mouse (blk, via USB)	45K1696	ann 11/25/08
Lenovo Wireless Laser Mouse (red, via USB)	51J0198	ann 11/25/08
Laser Tilt Wheel Travel Mouse (Bluetooth) ⁴⁵	41U5008	ann 01/22/08

⁴⁵ Requires Bluetooth enabled IdeaPad systems

Security

Kensington Cable Lock from Lenovo	73P2582	ann 12/29/03
Kensington Twin Head Cable Lock	45K1620	ann 09/30/08

Multimedia

USB 2.0 Lenovo Multimedia Headset	40Y8518	ann 06/27/06
USB 2.0 Lenovo Webcam	40Y8519	ann 08/29/06

Modem

USB 2.0 Lenovo Modem	43R1814	ann 02/26/08
----------------------	---------	--------------

Batteries

IdeaPad S9e/S10e Li-Ion Battery 3-cell (blk)	45K1274	ann 11/25/08
IdeaPad S9e/S10e Li-Ion Battery 6-cell (blk)	45K1275	ann 11/25/08
IdeaPad S9e/S10e Li-Ion Battery 3-cell (wht)	51J0398	ann 12/16/08
IdeaPad S9e/S10e Li-Ion Battery 6-cell (wht)	51J0399	ann 12/16/08
IdeaPad S9e/S10e 40W AC Adapter	41R4441	ann 11/25/08

Carrying Cases

IdeaPad S9e/S10e Case Sleeve	45K1609	ann 11/25/08
Lenovo Carrying Case - Messenger Max	41U5253	ann 05/01/07
Lenovo Standard Case	45K1697	ann 11/25/08
Lenovo Standard Backpack	45K1698	ann 11/25/08

Monitors

ThinkVision® L174 17" Monitor	9227AE1	ann 04/15/08
ThinkVision L1700p 17" Monitor	9417HE2	ann 09/17/08
ThinkVision L1940p Wide 19" Monitor	4424HB6	ann 09/17/08
ThinkVision L200p Wide 20.1" Monitor	4438HB6	ann 04/15/08
ThinkVision L2240p Wide 22" Monitor	4422HB6	ann 09/17/08
ThinkVision L2440p Wide 24" Monitor	4420HB2	ann 09/17/08
ThinkVision L2440x Wide 24" Monitor	4421HB2	ann 09/17/08

Monitor Accessories⁴⁶

ThinkVision USB Soundbar	40Y7616	ann 08/23/05
ThinkVision Soundbar (L1900p, 24" Wide)	45K1263	ann 09/16/08
Kensington Cable Lock from Lenovo	73P2582	ann 12/29/03
Kensington Twin Head Cable Lock	45K1620	ann 09/30/08
ThinkPad Convertible Monitor Stand	40Y7620	ann 01/05/06
Radial Arm	19K4464	ann 05/05/00

⁴⁶ Compatible on selected ThinkVision monitors.**Consumer monitors**

Lenovo L195 Wide 19" LCD Monitor	4418HC1	ann 09/02/08
Lenovo L222 Wide 22" LCD Monitor	4432HF1	ann 09/02/08

Other accessories at <http://www.lenovo.com/accessories>Accessories Guide pdf at <http://www.lenovo.com/accessoriesguide>

**Partial list of Lenovo® ThinkPlus Services⁷
for IdeaPad® S9e/S10e**

For more information see:

http://www.lenovo.com/services_warranty/us/en/index.html

ThinkPlus service upgrade options

IdeaPad® S9e/S10e with Split warranty

Depot = Depot repair, ADP = Accidental Damage Protection

1-year Depot warranty 9x5	51J0704
2-year Depot warranty 9x5	51J0703
3-year Depot warranty 9x5	51J0702
4-year Depot warranty 9x5	51J0808
1-year Depot warranty 9x5 with ADP	51J0699
2-year Depot warranty 9x5 with ADP	51J0698
3-year Depot warranty 9x5 with ADP	51J0810
4-year Depot warranty 9x5 with ADP	51J0814

LOR = Lenovo Onsite Repair, ADP = Accidental Damage Protection

1-year LOR 9x5 Next Business Day	51J0701
2-year LOR 9x5 Next Business Day	51J0700
3-year LOR 9x5 Next Business Day	55Y3380
4-year LOR 9x5 Next Business Day	51J0809
1-year LOR 9x5 Next Business Day with ADP	51J0811
2-year LOR 9x5 Next Business Day with ADP	51J0812
3-year LOR 9x5 Next Business Day with ADP	51J0813
4-year LOR 9x5 Next Business Day with ADP	51J0815

ideapad



Lenovo IdeaPad S10
Classic White



Lenovo IdeaPad S10
Deep Blue



Lenovo IdeaPad S10
Bold Black, Ruby Red,
Deep Blue, Classic White, Pastel Pink



Lenovo IdeaPad S10
Pastel Pink



Lenovo IdeaPad S10
Ruby Red



Lenovo IdeaPad S10
Ruby Red

Part number	Processor	GHz	Memory	Widescreen display	Camera	Integrated graphics	SATA disk	Mini PCIe 802.11 wireless	Color	Blue-tooth	Battery	Preload	Avail date
59015819	Atom N270	1.60	512MB	10.2" WSVGA	Cam	GMA	80GB ⁸	11b/g ¹¹	Pink	None	3-cell	XP Home	Sep 08
59015866	Atom N270	1.60	512MB	10.2" WSVGA	Cam	GMA	80GB	11b/g	White	None	3-cell	XP Home	Sep 08
59015875	Atom N270	1.60	512MB	10.2" WSVGA	Cam	GMA	80GB	11b/g	Black	None	3-cell	XP Home	Sep 08
59015864	Atom N270	1.60	512MB	10.2" WSVGA	Cam	GMA	80GB	11b/g	Black	None	3-cell	XP Home	Nov 08
59015817	Atom N270	1.60	512MB	10.2" WSVGA	Cam	GMA	80GB	11b/g	Red	None	3-cell	XP Home	Nov 08
59016575	Atom N270	1.60	1GB	10.2" WSVGA	Cam	GMA	160GB	11b/g	Black	None	3-cell	XP Home	Nov 08
59016410	Atom N270	1.60	1GB	10.2" WSVGA	Cam	GMA	160GB	11b/g	Black	None	3-cell	XP Home	Dec 08
59016593	Atom N270	1.60	1GB	10.2" WSVGA	Cam	GMA	160GB	11b/g	White	None	3-cell	XP Home	Nov 08
59016604	Atom N270	1.60	1GB	10.2" WSVGA	Cam	GMA	160GB	11b/g	Red	None	3-cell	XP Home	Nov 08

- **Lenovo's netbook: smaller and lighter than a notebook**
- **10.2" widescreen, anti-glare display display with LED backlight**
- **Super-slim (starts at 0.9 inches thin), ultra-light (weighs just over 2.43 pounds)**
- **Multiple color choices: black, white, red, blue, or pink (piano finish for red, blue, pink)**
- **Touch pad supports multi-touch function to enhance the experience of user control**
- **Integrated 1.3 megapixel camera**
- **OneKey™ Rescue System includes OneKey Recovery with press of recovery key**

Positioning	<i>Netbook; consumer markets</i>							Preloaded operating system²⁰					
Processor	Intel® Atom™ Processor N270 with single-core, Hyper-Threading technology, 533MHz system bus, and 512KB L2 cache							- Microsoft® Windows® XP Home Edition					
Memory	512MB or 1GB std / 1.5GB max ⁷ / PC2-5300 667MHz DDR2, non-parity, single-channel, one 200-pin SO-DIMM socket; <i>Italics:</i> standard memory 512MB soldered to systemboard, 512MB in socket; no sockets available; <i>Non-italics:</i> standard memory 512MB soldered to systemboard; one socket available							Preloaded applications¹⁴					
Diskette drive	None							• Lenovo™ OneKey Recovery					
External combo	None							• Norton Internet Security™					
SATA disk	80GB (5400 rpm) or 160GB (5400 rpm) / SATA 1.5Gb/s, 9.5mm high, 2.5" wide, not removable							• (90 days of virus definitions)					
Widescreen display	10.2" (259.1mm) WSVGA (1024x600) TFT color, anti-glare, LED backlight, 200 nits, 16:10 aspect ratio, 300:1 contrast ratio,							• Adobe® Reader					
Camera	Camera on top of screen, 1.3-megapixel, fixed focus							• Windows Live™ Toolbar					
Graphics	Intel Graphics Media Accelerator 950 (GMA 950), in 945GSE							• Lenovo Energy Management Software					
Keyboard	6-row, 80-key, 85% size, multimedia Fn keys, recovery key, wireless on/off button							Available at these retailers					
Touch pad	Two-button touch pad with scroll feature (no TrackPoint®), multi-touch							• Newegg®					
Dimensions ³	(WxDxH): 9.8" x 7.2" x 0.9-1.1"; 250mm x 183mm x 22-27.5mm							• TigerDirect					
Weight ²	3-cell: starting at 2.43 lb (1.1 kg)							• Amazon.com					
Case color	<i>Top:</i> multiple color choices black, white, red, blue, or pink (piano finish for red, blue, pink) <i>Bottom:</i> color matches top color							• Supercom (Canada)					
Case material	Polycarbonate/Acrylonitrile-Butadiene-Styrene (PC/ABS) plastic							• BeachCamera.com™					
Battery - type	Lithium Ion, 3-cell 2600 mAh							40-watt AC adapter					
Battery - life ¹⁰	3-cell: up to 2.5 hr							ENERGY STAR® 4.0-compliant					
Chipset	Mobile Intel 945GSE Express Chipset (Graphics Memory Controller Hub), ICH7M I/O Controller Hub (SATA 1.5Gb/s, USB 2.0, PCI Express® 1.1, PCI 2.3, ethernet MAC)							RoHS-compliant					
ExpressCard/34	One slot (ExpressCard/34)							Limited Warranty¹²					
Multicard reader	4-in-1 reader (MultiMedia Card, Memory Stick®, Memory Stick PRO™, Secure Digital Card)							↪ 1-year parts and labor					
Ports	Two USB 2.0, external monitor (VGA DB-15), ethernet (RJ-45)							↪ Depot repair service ¹⁹					
TV tuner	None							↪ Service upgrade options (in eligible locations): ⁹					
Mini PCI Express	One Mini PCI Express slot							• 1-year accidental damage protection via depot 43R8885					
11b/g ²⁸	11b/g wireless ⁴ , Mini PCIe adapter, Broadcom® BCM4312							• 3-year Lenovo Onsite Repair ¹³ 9x5 Next Business Day 43R8883					
Bluetooth™	None							• 3-year Lenovo Onsite Repair ¹³ 9x5 Next Business Day with accidental damage protection 43R8884					
Modem	None							↪ 24x ¹⁶ toll-free support for warranty issues during the warranty period ¹² via 877-453-6686					
Ethernet	10/100 ethernet, Broadcom® BCM5906, PCI 2.3												
Audio support	High Definition (HD) Audio, RealTek® ALC269 codec / two stereo speakers (1.5 watt) / stereo microphone, microphone input jack (3.5 mm), stereo headphone jack (3.5 mm)												
Security	Power-on password, supervisor password, security keyhole												
Fingerprint reader	None												

See footnotes for important warranty information

US model announced December 10, 2008; previous models on September 9 or November 12, 2008

© Lenovo

(MRA1-2) December 2008

Type-model	Processor	GHz	Memory	Widescreen display	Camera	Integrated graphics	SATA disk	Mini PCIe 802.11 wireless	Color	Blue-tooth	Battery	Preload	Avail date
4231-2BU	Atom N270	1.60	512MB	10.2" WSVGA	Cam	GMA	80GB ⁸	11b/g ¹¹	Black	None	3-cell	XP Home	Aug 08
4231-3AU	Atom N270	1.60	512MB	10.2" WSVGA	Cam	GMA	80GB	11b/g	Black	None	3-cell	XP Home	Sep 08
4231-2CU	Atom N270	1.60	512MB	10.2" WSVGA	Cam	GMA	80GB	11b/g	White	None	3-cell	XP Home	Aug 08
4231-2DU	Atom N270	1.60	512MB	10.2" WSVGA	Cam	GMA	80GB	11b/g	Red	None	3-cell	XP Home	Aug 08
4231-36U	Atom N270	1.60	512MB	10.2" WSVGA	Cam	GMA	80GB	11b/g	Blue	None	3-cell	XP Home	Oct 08
ESP 4231-2AU	Atom N270	1.60	512MB	10.2" WSVGA	Cam	GMA	80GB	11b/g	Pink	None	3-cell	XP Home	Dec 08
4231-3CU	Atom N270	1.60	1GB	10.2" WSVGA	Cam	GMA	160GB	11b/g	Black	None	3-cell	XP Home	Sep 08
4231-3DU	Atom N270	1.60	1GB	10.2" WSVGA	Cam	GMA	160GB	11b/g	Black	None	3-cell	XP Home	Sep 08
ESP 4231-35U	Atom N270	1.60	1GB	10.2" WSVGA	Cam	GMA	160GB	11b/g	Black	None	3-cell	XP Home	Dec 08
ESP 4231-34U	Atom N270	1.60	1GB	10.2" WSVGA	Cam	GMA	160GB	11b/g	White	None	3-cell	XP Home	Dec 08
ESP 4231-33U	Atom N270	1.60	1GB	10.2" WSVGA	Cam	GMA	160GB	11b/g	Red	None	3-cell	XP Home	Dec 08
4231-37U	Atom N270	1.60	1GB	10.2" WSVGA	Cam	GMA	160GB	11b/g	Blue	None	3-cell	XP Home	Oct 08
ESP 4231-32U	Atom N270	1.60	1GB	10.2" WSVGA	Cam	GMA	160GB	11b/g	Pink	None	3-cell	XP Home	Dec 08

- **Lenovo's netbook: smaller and lighter than a notebook**
- **10.2" widescreen, anti-glare display with LED backlight**
- **Super-slim (starts at 0.9 inches thin), ultra-light (weighs just over 2.43 pounds)**
- **Multiple color choices: black, white, red, blue, or pink (piano finish for red, blue, pink)**
- **Touch pad supports multi-touch function to enhance the experience of user control**
- **Integrated 1.3 megapixel camera**
- **OneKey™ Rescue System includes OneKey Recovery with press of recovery key**

Positioning Processor	<i>Netbook; consumer markets</i> Intel® Atom™ Processor N270 with single-core, Hyper-Threading technology, 533MHz system bus, and 512KB L2 cache	Preloaded operating system ²⁰ - Microsoft® Windows® XP Home Edition
Memory	512MB or 1GB std / 1.5GB max ⁷ / PC2-5300 667MHz DDR2 , non-parity, single-channel, one 200-pin SO-DIMM socket; <i>Italics:</i> standard memory 512MB soldered to systemboard, 512MB in socket; no sockets available; <i>Non-italics:</i> standard memory 512MB soldered to systemboard; one socket available	Preloaded applications ¹⁴ • Lenovo™ OneKey Recovery • Norton Internet Security™ (90 days of virus definitions) • Adobe® Reader • Windows Live™ Toolbar • Lenovo Energy Management Software
Diskette drive	None	Available at these retailers • lenovo.com • Fry's • Circuit City®
External combo SATA disk	None 80GB (5400 rpm) or 160GB (5400 rpm) / SATA 1.5Gb/s, 9.5mm high, 2.5" platter, not removable	
Widescreen display	10.2" (259.1mm) WSVGA (1024x600) TFT color , anti-glare, LED backlight , 200 nits, 16:10 aspect ratio, 300:1 contrast ratio	40-watt AC adapter ENERGY STAR® 4.0-compliant RoHS-compliant
Camera	Camera on top of screen, 1.3-megapixel, fixed focus	
Graphics	Intel Graphics Media Accelerator 950 (GMA 950) , in 945GSE	Limited Warranty ¹² ↪ 1-year parts and labor ↪ Depot repair service ¹⁹ ↪ Service upgrade options (in eligible locations): ⁹ • 1-year accidental damage protection via depot 43R8885 • 3-year Lenovo Onsite Repair ¹³ 9x5 Next Business Day 43R8883 • 3-year Lenovo Onsite Repair ¹³ 9x5 Next Business Day with accidental damage protection 43R8884 ↪ 24x7¹⁶ toll-free support for warranty issues during the warranty period ¹² via 877-453-6686
Keyboard	6-row, 80-key, 85% size, multimedia Fn keys, recovery key, wireless on/off button	
Touch pad	Two-button touch pad with scroll feature (no TrackPoint®), multi-touch	
Dimensions ³	<i>(WxDxH):</i> 9.8" x 7.2" x 0.9-1.1"; 250mm x 183mm x 22-27.5mm	
Weight ²	<i>3-cell:</i> starting at 2.43 lb (1.1 kg)	
Case color	<i>Top:</i> multiple color choices: black, white, red, blue, or pink (piano finish for red, blue, pink) <i>Bottom:</i> color matches top color	
Case material	Polycarbonate/Acrylonitrile-Butadiene-Styrene (PC/ABS) plastic	
Battery - type	Lithium Ion, 3-cell 2600 mAh	
Battery - life ¹⁰	<i>3-cell:</i> up to 2.5 hr	
Chipset	Mobile Intel 945GSE Express Chipset (Graphics Memory Controller Hub), ICH7M I/O Controller Hub (SATA 1.5Gb/s, USB 2.0, PCI Express® 1.1, PCI 2.3, ethernet MAC)	
ExpressCard/34 Multicard reader	One slot (ExpressCard/34) 4-in-1 reader (MultiMedia Card, Memory Stick®, Memory Stick PRO™, Secure Digital Card)	
Ports	Two USB 2.0, external monitor (VGA DB-15), ethernet (RJ-45)	
TV tuner	None	
Mini PCI Express	One Mini PCI Express slot 11b/g wireless ⁴ , Mini PCIe adapter, Broadcom® BCM4312	
Bluetooth™	None	
Modem	None	
Ethernet	10/100 ethernet, Broadcom® BCM5906, PCI 2.3	
Audio support	High Definition (HD) Audio, RealTek® ALC269 codec / two stereo speakers (1.5 watt) / stereo microphone, microphone input jack (3.5 mm), stereo headphone jack (3.5 mm)	
Security	Power-on password, supervisor password, security keyhole,	
Fingerprint reader	None	

See footnotes for important warranty information

ESP US models announced December 10, 2008; previous models on August 19, September 9, or October 7, 2008

© Lenovo (MRA1-1) December 2008



Lenovo IdeaPad U110



Lenovo IdeaPad U110
(also available with black top)



Lenovo IdeaPad U110



Lenovo IdeaPad U110



Lenovo IdeaPad U110
(also available with black top)



Lenovo IdeaPad U110

Part number	Low Voltage processor	GHz	Memory	Widescreen display	Camera	Graphics controller	EIDE disk	USB external optical	Mini PCIe 802.11 wireless	Top color	Batteries	Vista preload	Avail date
59014189	L7500	1.60	3GB	11.1" WXGA	Cam	GMA	120GB ⁸	DVD±RW	*4965AG ¹¹	Red	4- + 7-cell	Home Prem	Jun 08
59014294	L7500	1.60	3GB	11.1" WXGA	Cam	GMA	120GB	DVD±RW	*4965AG	Red	4- + 7-cell	Home Prem	Jun 08
59014847	L7500	1.60	3GB	11.1" WXGA	Cam	GMA	120GB	DVD±RW	*4965AG	Red	4- + 7-cell	Home Prem	Jul 08
59014234	L7500	1.60	3GB	11.1" WXGA	Cam	GMA	120GB	DVD±RW	*4965AG	Black	4- + 7-cell	Home Prem	Jun 08
59014295	L7500	1.60	3GB	11.1" WXGA	Cam	GMA	120GB	DVD±RW	*4965AG	Black	4- + 7-cell	Home Prem	Jun 08
59014245	L7500	1.60	3GB	11.1" WXGA	Cam	GMA	120GB	DVD±RW	*4965AG	Black	4- + 7-cell	Home Prem	Jul 08
59014843	L7500	1.60	3GB	11.1" WXGA	Cam	GMA	120GB	DVD±RW	*4965AG	Black	4- + 7-cell	Home Prem	Aug 08
59014844	L7500	1.60	3GB	11.1" WXGA	Cam	GMA	120GB	DVD±RW	*4965AG	Black	4- + 7-cell	Home Prem	Sep 08
59014845	L7500	1.60	3GB	11.1" WXGA	Cam	GMA	120GB	DVD±RW	*4965AG	Black	4- + 7-cell	Home Prem	Sep 08

- **11.1" widescreen, glossy display**
- **Frameless screen (no plastic frame) to extend to the edges of the PC**
- **The thinnest and lightest of versatile ultraportables; starting at 0.7 inch high and 2.42 pounds**
- **Top cover with tendril textured floral pattern**
- **Bottom air vents resemble scroll patterns from antique Chinese rosewood furniture**
- **Cherry blossom design on bottom cover**
- **Ultra-glossy keyboard reminiscent of glass**
- **Integrated 1.3 megapixel camera and Lenovo's VeriFace facial recognition software helps control access to your notebook by recognizing your face**
- **Dolby® Home Theater™ premium audio system with two stereo speakers**
- **Shuttle Center offers a one-stop, total entertainment environment with Shuttle Key that puts volume control on the keyboard**



Lenovo IdeaPad U110 (also available with black top)

Positioning	<i>Ultimate mobility; one-spindle</i>	Preloaded operating system ²⁰ - Microsoft® Windows® Vista® Home Premium Edition (32-bit) ↕ Vista Premium logo
Processor	Intel® Core™ 2 Duo processor L7500 with low voltage, dual-core , Intel 64 Technology, Enhanced Intel SpeedStep® technology ¹ , Intel Dynamic Acceleration, Execute Disable Bit, Virtualization Technology, 800MHz system bus, and 4MB L2 cache	
Memory	3GB std / 3GB max ⁷ / PC2-5300 667MHz DDR2 , non-parity, dual-channel capable, one 200-pin SO-DIMM socket; <i>Italics:</i> std memory 1GB soldered to systemboard, 2GB in socket; no sockets avail	Preloaded applications ¹⁴ • Lenovo™ OneKey Recovery • Lenovo Anycomm • Norton® AntiVirus 2007 (90 days of virus definitions) • Adobe® Reader • Windows Live™ Toolbar • Easy Capture • Microsoft Office 2007 Trial (60-day) • VeriFace™ Facial Recognition™ • EarthLink® • Lenovo Energy Management Software • Lenovo Shuttle Center (DVD±RW) • Cyberlink Power2Go (DVD±RW)
Diskette drive	None	
External DVD±RW	USB 2.0 external DVD burner, dual-layer support, 12.7mm high, tray-in	Available at these retailers • B&H™ • Newegg® • TigerDirect • MICROCENTER® • Best Buy™ • The Source (Canada)
EIDE disk	120GB (4200 rpm) / ATA-100, 8mm high, 1.8" wide, not removable, Active Protection System™	
Widescreen display	11.1" (281.9mm) WXGA (1366x768) TFT color, VibrantView (glossy), CCFL backlight, 370 nits, 16:9 aspect ratio, 500:1 contrast ratio, frameless screen	Limited Warranty ¹² ↕ 1-year parts and labor ↕ Depot repair service ¹⁹ ↕ Service upgrade options (in eligible locations): ⁹ • 1-year accidental damage protection via depot 43R8885 • 3-year Lenovo Onsite Repair ¹³ 9x5 Next Business Day 43R8883 • 3-year Lenovo Onsite Repair ¹³ 9x5 Next Business Day with accidental damage protection 43R8884 ↕ 24x7¹⁶ toll-free support for warranty issues during the warranty period ¹² via 877-453-6686
Camera	Camera on top of screen, 1.3-megapixel, fixed focus	
Graphics	Intel Graphics Media Accelerator X3100 , in GM965	65-watt AC adapter Wireless on/off switch ENERGY STAR® 4.0-compliant RoHS-compliant
Keyboard	Ultra-glossy keyboard, 6-row, 83-key, multimedia Fn keys	
Multimedia controls	Touch-sensitive audio-video control panel, Shuttle Key	ExpressCard One slot (ExpressCard/34)
Touch pad	Two-button touch pad with scroll feature (no TrackPoint®)	
Dimensions ³	(WxDxH): 10.8" x 7.7" x 0.7-0.9"; 275mm x 196mm x 18.4-22.4mm	Multicard reader 4-in-1 reader (MultiMedia Card, Memory Stick®, Memory Stick PRO™, Secure Digital Card, Secure Digital Elite Pro Card, xD-Picture Card™)
Weight ²	4-cell: starting at 2.42 lb (1.09kg); 7-cell: starting at 2.92 lb (1.32kg)	
Case color	Red or black top, black bottom	Ports Three USB 2.0, external monitor (VGA DB-15), ethernet (RJ-45), IEEE 1394 FireWire 400 (4-pin connector; 1394a-2000 standard)
Case material	Top: aluminum alloy; Bottom: magnesium-aluminum alloy	
Battery - type	Lithium Ion, 4-cell 1750 mAh and 7-cell 4600 mAh	TV tuner None
Battery - life ¹⁰	4-cell: up to 2.0 hr; 7-cell: up to 6.0 hr	
Chipset	Mobile Intel GM965 Express Chipset (Graphics Memory Controller Hub); ICH8M I/O Controller Hub (SATA 3.0Gb/s, ATA-100 EIDE, USB 2.0, PCI Express® 1.1, PCI 2.3), LPC bus	Mini PCI Express One Mini PCI Express slot
ExpressCard	One slot (ExpressCard/34)	
Multimedia reader	4-in-1 reader (MultiMedia Card, Memory Stick®, Memory Stick PRO™, Secure Digital Card, Secure Digital Elite Pro Card, xD-Picture Card™)	Intel 4965AG ³² 11a/g wireless ⁴ , Mini PCIe adapter, Intel Wireless WiFi Link 4965AG
Ports	Three USB 2.0, external monitor (VGA DB-15), ethernet (RJ-45), IEEE 1394 FireWire 400 (4-pin connector; 1394a-2000 standard)	
TV tuner	None	Bluetooth™ Bluetooth 2.0 wireless, USB 2.0 interface via ICH8M, LED indicator
Mini PCI Express	One Mini PCI Express slot	
Intel 4965AG ³²	11a/g wireless ⁴ , Mini PCIe adapter, Intel Wireless WiFi Link 4965AG	Modem None
Bluetooth™	Bluetooth 2.0 wireless, USB 2.0 interface via ICH8M, LED indicator	
Modem	None	Ethernet 10/100 ethernet, Broadcom® BCM5906M, PCI 2.3
Ethernet	10/100 ethernet, Broadcom® BCM5906M, PCI 2.3	
Audio support	Intel High Definition (HD) Audio, RealTek® ALC888S codec / two stereo speakers (1.5 watt), Dolby® Home Theater™ speaker system / stereo microphone, microphone input jack (3.5 mm), stereo headphone jack (3.5 mm)	Security Power-on password, hard disk password, supervisor password, security keyhole, VeriFace facial recognition software
Security	Power-on password, hard disk password, supervisor password, security keyhole, VeriFace facial recognition software	
Fingerprint reader	None	

See footnotes for important warranty information

* Intel Centrino® processor technology

† US models announced September 9, 2008; previous models on June 2 or July 15, 2008

Type-model	Low Voltage processor	GHz	Memory	Widescreen display	Cam- era	Graphics controller	EIDE disk	USB external optical	Mini PCIe 802.11 wireless	Top color	Blue-tooth	Batteries	Vista preload	Avail date
2304-2AU	L7500	1.60	2GB	11.1" WXGA	Cam	GMA	120GB ⁸	DVD±RW	* 4965AG ¹¹	Red	Blue	4- + 7-cell	Home Prem	May 08
2304-2BU	L7500	1.60	2GB	11.1" WXGA	Cam	GMA	120GB	DVD±RW	* 4965AG	Black	Blue	4- + 7-cell	Home Prem	May 08
2304-3AU	L7500	1.60	3GB	11.1" WXGA	Cam	GMA	120GB	DVD±RW	* 4965AG	Red	Blue	4- + 7-cell	Home Prem	Aug 08
2304-3BU	L7500	1.60	3GB	11.1" WXGA	Cam	GMA	120GB	DVD±RW	* 4965AG	Black	Blue	4- + 7-cell	Home Prem	Aug 08
2304-4AU	L7500	1.60	3GB	11.1" WXGA	Cam	GMA	120GB	DVD±RW	* 4965AG	Red	Blue	4- + 7-cell	Home Prem	Sep 08
2304-4BU	L7500	1.60	3GB	11.1" WXGA	Cam	GMA	120GB	DVD±RW	* 4965AG	Black	Blue	4- + 7-cell	Home Prem	Sep 08

- 11.1" widescreen, glossy display
- Frameless screen (no plastic frame) to extend to the edges of the PC
- The thinnest and lightest of versatile ultraportables; starting at 0.7 inch high and 2.42 pounds
- Top cover with tendril textured floral pattern
- Bottom air vents resemble scroll patterns from antique Chinese rosewood furniture
- Cherry blossom design on bottom cover
- Ultra-glossy keyboard reminiscent of glass
- Integrated 1.3 megapixel camera and Lenovo's VeriFace facial recognition software helps control access to your notebook by recognizing your face
- Dolby® Home Theater™ premium audio system with two stereo speakers
- Shuttle Center offers a one-stop, total entertainment environment with Shuttle Key that puts volume control on the keyboard



Lenovo IdeaPad U110 (also available with red top)

Positioning Processor	Ultimate mobility; one-spindle Intel® Core™ 2 Duo processor L7500 with low voltage, dual-core, Intel 64 Technology, Enhanced Intel SpeedStep® technology ¹ , Intel Dynamic Acceleration, Execute Disable Bit, Virtualization Technology, 800MHz system bus, and 4MB L2 cache	Preloaded operating system ²⁰ - Microsoft® Windows® Vista® Home Premium Edition (32-bit) ◇ Vista Premium logo
Memory	2GB or 3GB std / 3GB max ⁷ / PC2-5300 667MHz DDR2, non-parity, dual-channel capable, one 200-pin SO-DIMM socket; <i>Italics:</i> std memory 1GB soldered to systemboard, 1GB or 2GB in socket; no sockets available	Preloaded applications ¹⁴ • Lenovo™ OneKey Recovery • Lenovo Anycomm • Norton® AntiVirus 2007 (90 days of virus definitions) • Adobe® Reader • Windows Live™ Toolbar • Easy Capture • Microsoft Office 2007 Trial (60-day) • VeriFace™ Facial Recognition™ • EarthLink® • Lenovo Energy Management Software • Lenovo Shuttle Center (DVD±RW) • Cyberlink Power2Go (DVD±RW)
Diskette drive	None	Available at these retailers • lenovo.com • Fry's
External DVD±RW EIDE disk	USB 2.0 external DVD burner, dual-layer support, 12.7mm high, tray-in 120GB (4200 rpm) / ATA-100, 8mm high, 1.8" wide, not removable, Active Protection System™	
Widescreen display	11.1" (281.9mm) WXGA (1366x768) TFT color, VibrantView (glossy), CCFL backlight, 370 nits, 16:9 aspect ratio, 500:1 contrast ratio, frameless screen	65-watt AC adapter Wireless on/off switch ENERGY STAR® 4.0-compliant RoHS-compliant
Camera	Camera on top of screen, 1.3-megapixel, fixed focus	
Graphics	Intel Graphics Media Accelerator X3100, in GM965	Limited Warranty¹² ⇨ 1-year parts and labor ⇨ Depot repair service ¹⁹ ⇨ Service upgrade options (in eligible locations): ⁹ • 1-year accidental damage protection via depot 43R8885 • 3-year Lenovo Onsite Repair ¹³ 9x5 Next Business Day 43R8883 • 3-year Lenovo Onsite Repair ¹³ 9x5 Next Business Day with accidental damage protection 43R8884 ⇨ 24x7 ¹⁶ toll-free support for warranty issues during the warranty period ¹² via 877-453-6686
Keyboard	Ultra-glossy keyboard, 6-row, 83-key, multimedia Fn keys	
Multimedia controls	Touch-sensitive audio-video control panel, Shuttle Key	⇨ 24x7 ¹⁶ toll-free support for warranty issues during the warranty period ¹² via 877-453-6686
Touch pad	Two-button touch pad with scroll feature (no TrackPoint®)	
Dimensions ³	(WxDxH): 10.8" x 7.7" x 0.7-0.9"; 275mm x 196mm x 18.4-22.4mm	⇨ 24x7 ¹⁶ toll-free support for warranty issues during the warranty period ¹² via 877-453-6686
Weight ²	4-cell: starting at 2.42 lb (1.09kg); 7-cell: starting at 2.92 lb (1.32kg)	
Case color	Red or black top, black bottom	⇨ 24x7 ¹⁶ toll-free support for warranty issues during the warranty period ¹² via 877-453-6686
Case material	Top: aluminum alloy; Bottom: magnesium-aluminum alloy	
Battery - type	Lithium Ion, 4-cell 1750 mAh and 7-cell 4600 mAh	⇨ 24x7 ¹⁶ toll-free support for warranty issues during the warranty period ¹² via 877-453-6686
Battery - life ¹⁰	4-cell: up to 2.0 hr; 7-cell: up to 6.0 hr	
Chipset	Mobile Intel GM965 Express Chipset (Graphics Memory Controller Hub); ICH8M I/O Controller Hub (SATA 3.0Gb/s, ATA-100 EIDE, USB 2.0, PCI Express® 1.1, PCI 2.3), LPC bus	⇨ 24x7 ¹⁶ toll-free support for warranty issues during the warranty period ¹² via 877-453-6686
ExpressCard/34	One slot (ExpressCard/34)	
Multicard reader	4-in-1 reader (MultiMedia Card, Memory Stick®, Memory Stick PRO™, Secure Digital Card, Secure Digital Elite Pro Card, xD-Picture Card™)	⇨ 24x7 ¹⁶ toll-free support for warranty issues during the warranty period ¹² via 877-453-6686
Ports	Three USB 2.0, external monitor (VGA DB-15), ethernet (RJ-45), IEEE 1394 FireWire 400 (4-pin connector; 1394a-2000 standard)	
TV tuner	None	⇨ 24x7 ¹⁶ toll-free support for warranty issues during the warranty period ¹² via 877-453-6686
Mini PCI Express	One Mini PCI Express slot	
Intel 4965AG ³²	11a/g wireless ⁴ , Mini PCIe adapter, Intel Wireless WiFi Link 4965AG	⇨ 24x7 ¹⁶ toll-free support for warranty issues during the warranty period ¹² via 877-453-6686
Bluetooth™	Bluetooth 2.0 wireless, USB 2.0 interface via ICH8M, LED indicator	
Modem	None	⇨ 24x7 ¹⁶ toll-free support for warranty issues during the warranty period ¹² via 877-453-6686
Ethernet	10/100 ethernet, Broadcom® BCM5906M, PCI 2.3	
Audio support	High Definition (HD) Audio, RealTek® ALC888S codec / two stereo speakers (1.5 watt), Dolby® Home Theater™ speaker system / stereo microphone, microphone input jack (3.5 mm), stereo headphone jack (3.5 mm)	⇨ 24x7 ¹⁶ toll-free support for warranty issues during the warranty period ¹² via 877-453-6686
Security	Power-on password, hard disk password, supervisor password, security keyhole, VeriFace facial recognition software	
Fingerprint reader	None	⇨ 24x7 ¹⁶ toll-free support for warranty issues during the warranty period ¹² via 877-453-6686

See footnotes for important warranty information * Intel Centrino® processor technology
 Ⓢ US models announced September 9, 2008; previous models on April 29 or August 12, 2008



Lenovo IdeaPad U330



Lenovo IdeaPad U330



Lenovo IdeaPad U330



Lenovo IdeaPad U330



Lenovo IdeaPad U330



Lenovo IdeaPad U330

Part number	Processor	GHz	Memory	Widescreen display	Camera	Switchable graphics	SATA disk	SATA optical	Mini PCIe 802.11 wireless	Top color	Battery	Vista preload	Avail date
59015270	P7350	2.00	3GB	13.3" WXGA	Cam	GMA, HD 3450	250GB ⁸	DVD±RW	✧ Intel 5100 ²⁸	Black	6-cell	Home Prem	Nov 08
59016807	P7350	2.00	3GB	13.3" WXGA	Cam	GMA, HD 3450	250GB	DVD±RW	✧ Intel 5100	Black	6-cell	Home Prem	Nov 08
59016806	P7350	2.00	3GB	13.3" WXGA	Cam	GMA, HD 3450	250GB	DVD±RW	✧ Intel 5100	Black	6-cell	Home Prem	Nov 08

- **The "U" series is about expressing ideas with style**
- **Super-slim (starts at 0.9 inches thin), ultra-light (weighs just over 4 pounds)**
- **13.3" widescreen, glossy display with LED backlight**
- **Bold black color with piano finish**
- **Dynamic switching between discrete and integrated graphics (user selectable)**
- **Integrated 1.3 megapixel camera and Lenovo's VeriFace facial recognition software helps control access to your notebook by recognizing your face**
- **Dolby® Home Theater™ premium audio system with two stereo speakers**
- **HDMI port, HDCP-compliant**
- **Lenovo Rescue System provides OneKey recovery and OneKey Antivirus without booting into Windows**

Positioning Processor	<i>Widescreen flexibility; two-spindle</i> Intel® Core™ 2 Duo processor P7350 with dual-core, Intel HD Boost, 1066MHz system bus, and 3MB L2 cache	Preloaded operating system²⁰ - Microsoft® Windows® Vista® Home Premium Edition (32-bit) ✧ Vista Premium logo
Memory	3GB std / 4GB max ⁷ / PC3-8500 1066MHz DDR3 , non-parity, dual-channel capable, two 204-pin SO-DIMM sockets; <i>Italics:</i> standard memory in both sockets; no sockets available	Preloaded applications¹⁴ (only some listed)
Diskette drive	None	<ul style="list-style-type: none"> • Lenovo™ OneKey Recovery • Lenovo ReadyComm • Norton Internet Security™ (90 days of virus definitions) • Easy Capture • Microsoft Office 2007 Trial (60-day) • Napster™ To Go® • Carbonite Online Backup • VeriFace™ Facial Recognition™ • Lenovo Energy Management Software • Cyberlink Power2Go (DVD±RW)
SATA DVD±RW	DVD burner, dual-layer support, fixed, not removable, 9.5mm high, tray-in	
SATA disk	250GB (5400 rpm) / SATA 1.5Gb/s, 9.5mm high, removable, Active Protection System™	
Widescreen display	13.3" (337.8mm) WXGA (1280x800) TFT color, VibrantView (glossy), LED backlight , 300 nits, 16:10 aspect ratio, 300:1 contrast ratio, frameless screen	
Camera	Camera on top of screen, 1.3-megapixel, fixed focus	
Switchable graphics	Dynamic switching between discrete and integrated graphics (user selectable), Intel Graphics Media Accelerator 4500MHD (GMA 4500MHD) , in GM45, and ATI™ Mobility Radeon™ HD 3450 , PCI Express® x16, 256MB memory, DirectX® 10, ATI Avivo™ HD, VGA connector, HDMI connector, HDCP-compliant	
Keyboard	Full-size keyboard, 6-row, 84-key, multimedia Fn keys	Available at these retailers • B&H™ • J&R™ • MICROCENTER® • TigerDirect • Amazon.com • Supercom (Canada)
Multimedia controls	Touch-sensitive audio-video control panel, Shuttle Key	
Touch pad	Two-button touch pad with scroll feature (no TrackPoint®)	
Dimensions ³	(<i>WxDxH</i>): 12.5" x 9.3" x 0.9-1.1"; 318mm x 237mm x 23-28mm	90-watt AC adapter Wireless on/off switch ENERGY STAR® 4.0-compliant RoHS-compliant
Weight ²	<i>6-cell</i> : starting at 4.32 lb (1.96kg)	
Case color	Black top, black bottom	Limited Warranty¹² ⇨ 1-year parts and labor ⇨ Depot repair service¹⁹ ⇨ Service upgrade options (in eligible locations):⁹ • 1-year accidental damage protection via depot 43R8885 • 3-year Lenovo Onsite Repair¹³ 9x5 Next Business Day 43R8883 • 3-year Lenovo Onsite Repair¹³ 9x5 Next Business Day with accidental damage protection 43R8884 ⇨ 24x7¹⁶ toll-free support for warranty issues during the warranty period¹² via 877-453-6686
Case material	<i>Top</i> : magnesium-aluminum alloy; <i>Bottom</i> : magnesium-aluminum alloy	
Battery - type	Lithium Ion, 6-cell 5200 mAh	
Battery - life ¹⁰	Up to 3.5 hr (discrete graphics); up to 5.5 hr (integrated graphics)	
Chipset	Mobile Intel GM45 Express Chipset (Graphics Memory Controller Hub), ICH9M I/O Controller Hub (SATA 3.0Gb/s, USB 2.0, PCI Express® 1.1, PCI 2.3, ethernet MAC)	
ExpressCard/34	One slot (ExpressCard/34)	
Multicard reader	6-in-1 reader (MultiMedia Card, Memory Stick®, Memory Stick PRO™, Secure Digital Card, Secure Digital Elite Pro Card, xD-Picture Card™)	
Ports	Two USB 2.0, external monitor (VGA DB-15, HDMI), ethernet (RJ-45), IEEE 1394 FireWire 400 (4-pin connector; 1394a-2000 standard)	
TV tuner	None	
Mini PCI Express	One Mini PCI Express slot	
Intel 5100 ²⁸	11a/b/g/n wireless ⁴ , Mini PCIe adapter, Intel WiFi Link 5100, 1x2 (Shirley Peak)	
Bluetooth™	Bluetooth 2.0 wireless, USB 2.0 interface via ICH9M, LED indicator	
Modem	None	
Ethernet	10/100 ethernet, Broadcom® BCM5906M, PCI 2.3	
Audio support	High Definition (HD) Audio, RealTek® ALC269 codec / two stereo speakers (1.5 watt), Dolby® Home Theater™ speaker system / dual array microphone, microphone input jack (3.5 mm), headphone jack (3.5 mm)	
Security	Power-on password, hard disk password, supervisor password, security keyhole, VeriFace facial recognition software	
Fingerprint reader	None	

See footnotes for important warranty information
US models announced November 12, 2008

✧ Intel Centrino® 2 processor technology

© Lenovo
(OLP1-2) November 2008

Type-model	Processor	GHz	Memory	Widescreen display	Camera	Switchable graphics	SATA disk	SATA optical	Mini PCIe 802.11 wireless	Top color	Battery	Vista preload	Avail date
2267-2BU	P7350	2.00	2GB	13.3" WXGA	Cam	GMA, HD 3450	250GB ⁸	DVD±RW	Intel 5100 ²⁸	Black	6-cell	Home Prem	Aug 08
2267-3AU	P7350	2.00	3GB	13.3" WXGA	Cam	GMA, HD 3450	250GB	DVD±RW	Intel 5100	Black	6-cell	Home Prem	Sep 08
2267-2AU	P7350	2.00	3GB	13.3" WXGA	Cam	GMA, HD 3450	320GB	DVD±RW	Intel 5100	Black	6-cell	Home Prem	Aug 08

- The "U" series is about expressing ideas with style
- Super-slim (starts at 0.9 inches thin), ultra-light (weighs just over 4 pounds)
- 13.3" widescreen, glossy display with LED backlight
- Bold black color with piano finish
- Dynamic switching between discrete and integrated graphics (user selectable)
- Integrated 1.3 megapixel camera and Lenovo's VeriFace facial recognition software helps control access to your notebook by recognizing your face
- Dolby® Home Theater™ premium audio system with two stereo speakers
- HDMI port, HDCP-compliant
- Lenovo Rescue System provides OneKey recovery and OneKey Antivirus without booting into Windows

Positioning Processor	Widescreen flexibility; two-spindle Intel® Core™ 2 Duo processor P7350 with dual-core, Intel HD Boost, 1066MHz system bus, and 3MB L2 cache	Preloaded operating system²⁰ - Microsoft® Windows® Vista® Home Premium Edition (32-bit) ♦ Vista Premium logo Preloaded applications¹⁴ • Lenovo™ OneKey Recovery • Lenovo ReadyComm • Norton Internet Security™ (90 days of virus definitions) • Adobe® Reader • Windows Live™ Toolbar • Easy Capture • Microsoft Office 2007 Trial (60-day) • Napster™ To Go® • WildGames™ • Carbonite Online Backup • VeriFace™ Facial Recognition™ • Lenovo Energy Management Software • Cyberlink Power2Go (DVD±RW)
Memory	2GB or 3GB std / 4GB max ⁷ / PC3-8500 1066MHz DDR3 , non-parity, dual-channel capable, two 204-pin SO-DIMM sockets; <i>Italics:</i> standard memory in both sockets; no sockets available	
Diskette drive	None	
SATA DVD±RW	DVD burner, dual-layer support, fixed, not removable, 9.5mm high, tray-in	
SATA disk	250GB (5400 rpm) or 320GB (5400 rpm) / SATA 1.5Gb/s, 9.5mm high, removable Active Protection System™	
Widescreen display	13.3" (337.8mm) WXGA (1280x800) TFT color, VibrantView (glossy), LED backlight , 300 nits, 16:10 aspect ratio, 300:1 contrast ratio, frameless screen	
Camera	Camera on top of screen, 1.3-megapixel, fixed focus	
Switchable graphics	Dynamic switching between discrete and integrated graphics (user selectable), Intel Graphics Media Accelerator 4500MHD (GMA 4500MHD) , in GM45, and ATI™ Mobility Radeon™ HD 3450 , PCI Express® x16, 256MB memory, DirectX® 10, ATI Avivo™ HD, VGA connector, HDMI connector, HDCP-compliant	
Keyboard	Full-size keyboard, 6-row, 84-key, multimedia Fn keys	
Multimedia controls	Touch-sensitive audio-video control panel, Shuttle Key	
Touch pad	Two-button touch pad with scroll feature (no TrackPoint®)	
Dimensions ³	(<i>WxDxH</i>): 12.5" x 9.3" x 0.9-1.1"; 318mm x 237mm x 23-28mm	Available at these retailers • lenovo.com • Fry's
Weight ²	6-cell: starting at 4.32 lb (1.96kg)	
Case color	Black top, black bottom	
Case material	Top: magnesium-aluminum alloy; Bottom: magnesium-aluminum alloy	
Battery - type	Lithium Ion, 6-cell 5200 mAh	90-watt AC adapter Wireless on/off switch ENERGY STAR® 4.0-compliant RoHS-compliant
Battery - life ¹⁰	Up to 3.5 hr (discrete graphics); up to 5.5 hr (integrated graphics)	
Chipset	Mobile Intel GM45 Express Chipset (Graphics Memory Controller Hub), ICH9M I/O Controller Hub (SATA 3.0Gb/s, USB 2.0, PCI Express® 1.1, PCI 2.3, ethernet MAC)	Limited Warranty¹² ⇨ 1-year parts and labor ⇨ Depot repair service¹⁹ ⇨ Service upgrade options (in eligible locations):⁹ • 1-year accidental damage protection via depot 43R8885 • 3-year Lenovo Onsite Repair¹³ 9x5 Next Business Day 43R8883 • 3-year Lenovo Onsite Repair¹³ 9x5 Next Business Day with accidental damage protection 43R8884 ⇨ 24x7¹⁶ toll-free support for warranty issues during the warranty period¹² via 877-453-6686
ExpressCard/34	One slot (ExpressCard/34)	
Multicard reader	6-in-1 reader (MultiMedia Card, Memory Stick®, Memory Stick PRO™, Secure Digital Card, Secure Digital Elite Pro Card, xD-Picture Card™)	
Ports	Two USB 2.0, external monitor (VGA DB-15, HDMI), ethernet (RJ-45), IEEE 1394 FireWire 400 (4-pin connector; 1394a-2000 standard)	
TV tuner	None	
Mini PCI Express	One Mini PCI Express slot	
Intel 5100 ²⁸	11a/b/g/n wireless ⁴ , Mini PCIe adapter, Intel WiFi Link 5100, 1x2 (Shirley Peak)	
Bluetooth™	Bluetooth 2.0 wireless, USB 2.0 interface via ICH9M, LED indicator	
Modem	None	
Ethernet	10/100 ethernet, Broadcom® BCM5906M, PCI 2.3	
Audio support	High Definition (HD) Audio, RealTek® ALC269 codec / two stereo speakers (1.5 watt), Dolby® Home Theater™ speaker system / dual array microphone, microphone input jack (3.5 mm), headphone jack (3.5 mm)	
Security	Power-on password, hard disk password, supervisor password, security keyhole, VeriFace facial recognition software	
Fingerprint reader	None	

See footnotes for important warranty information ⇨ Intel Centrino® 2 processor technology
 Ⓢ US model announced September 9, 2008; previous models on August 19, 2008



Lenovo IdeaPad Y430

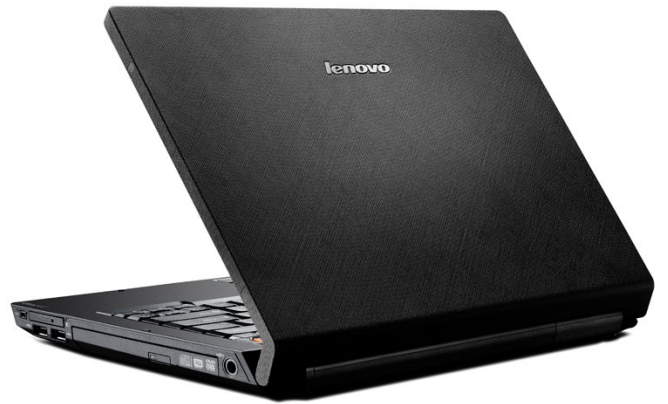

Lenovo IdeaPad Y430



Lenovo IdeaPad Y430



Lenovo IdeaPad Y430



Lenovo IdeaPad Y430



Lenovo IdeaPad Y430

Part number	Processor	GHz	Memory	Widescreen display	Camera	Integrated graphics	SATA disk	SATA optical	Mini PCIe 802.11 wireless	Top color	ENERGY STAR 4.0	Vista preload	Avail date
59015967	Pentium T3200	2.00	2GB	14.1" WXGA	Cam	GMA	160GB ⁸	DVD±RW	Intel 5100 ²⁸	Black		Prem 32	Oct 08
59015954	Pentium T3200	2.00	2GB	14.1" WXGA	Cam	GMA	160GB	DVD±RW	Intel 5100	Black		Prem 32	Dec 08
59016011	Pentium T3200	2.00	2GB	14.1" WXGA	Cam	GMA	250GB	DVD±RW	Intel 5100	Black		Prem 32	Nov 08
59015974	Pentium T3200	2.00	3GB	14.1" WXGA	Cam	GMA	160GB	DVD±RW	Intel 5100	Black		Prem 32	Oct 08
59016751	Core 2 Duo T5800	2.00	4GB	14.1" WXGA	Cam	GMA	250GB	DVD±RW	* Intel 5100	Black	ES40	Prem 64	Oct 08
59016838	Core 2 Duo T5800	2.00	4GB	14.1" WXGA	Cam	GMA	250GB	DVD±RW	* Intel 5100	Black	ES40	Prem 64	Nov 08
59016785	Core 2 Duo T5800	2.00	4GB	14.1" WXGA	Cam	GMA	320GB	DVD±RW	* Intel 5100	Black	ES40	Prem 64	Nov 08

- **14.1" widescreen, glossy display**
- **Light Weave textured cover**
- **Integrated 1.3 megapixel camera and Lenovo's VeriFace face recognition software helps control access to your notebook by recognizing your face.**
- **Dolby® Home Theater® premium audio system with two speakers and one subwoofer**
- **HDMI port, HDCP-compliant**
- **Lenovo Rescue System provides OneKey recovery and OneKey Antivirus without booting into Windows**
- **OneKey silence mode provides quieter operation through a touch-sensitive control button**

Positioning Processor	<i>Widescreen flexibility; two-spindle</i> Intel® Pentium® dual-core processor T3200 with dual-core, 667MHz system bus, and 1MB L2 cache or Intel Core™ 2 Duo processor T5800 with dual-core, 800MHz system bus, and 2MB L2 cache	Preloaded operating system²⁰ - Some: Microsoft® Windows® Vista® Home Premium Edition (32-bit) - Some: Microsoft Windows Vista Home Premium Edition (64-bit) Preloaded applications¹⁴ (only some listed) • Lenovo™ OneKey Recovery • Lenovo ReadyComm • Norton Internet Security™ (90 days of virus definitions) • Adobe® Reader • Easy Capture • Microsoft Office 2007 Trial (60-day) • VeriFace™ Facial Recognition • Lenovo Energy Management Software • Cyberlink Power2Go (DVD±RW)
Memory	2GB, 3GB, or 4GB std / 4GB max ⁷ / PC2-5300 667MHz DDR2 , non-parity, dual-channel capable, two 200-pin SO-DIMM sockets; <i>Italics:</i> standard memory in both sockets; no sockets available	
Diskette drive	None (use optional USB-based diskette drive)	
SATA DVD±RW	DVD burner, dual-layer support, fixed, not removable, 12.7mm high, tray-in	
SATA disk	160GB (5400 rpm), 250GB (5400 rpm), or 320GB (5400 rpm) / SATA 3.0Gb/s, 9.5mm high, removable	
Widescreen display	14.1" (358.1mm) WXGA (1280x800) TFT color, VibrantView (glossy), CCFL backlight, 200 nits, 16:10 aspect ratio, 400:1 contrast ratio	
Camera	Camera on top of screen, 1.3-megapixel, fixed focus	
Integrated graphics	Intel Graphics Media Accelerator 4500MHD (GMA 4500MHD) , in GM45, HDMI port supporting HDCP to output protected content	
Keyboard	Full-size keyboard, 6-row, 84-key, multimedia Fn keys, recovery key	
Multimedia controls	Touch-sensitive audio-video control panel, Shuttle Key	
Touch pad	Two-button touch pad with scroll feature (no TrackPoint®)	
Dimensions ³	(<i>WxDxH</i>): 13.1" x 9.5" x 1.0" to 1.5"; 334mm x 241mm x 26 to 38mm	Available at these retailers • B&H™ • J&R™ • TigerDirect • Amazon.com • Supercom (Canada)
Weight ²	with optical drive and battery: <i>6-cell</i> : 5.2 lb (2.35 kg)	
Case color	Black top, black bottom	
Case material	Polycarbonate/Acrylonitrile-Butadiene-Styrene (PC/ABS) plastic	
Battery - type	Lithium Ion 6-cell , 5200 mAh, smart battery	
Battery - life ¹⁰	Up to 5 hr	
Chipset	Mobile Intel GM45 Express Chipset (Memory Controller Hub), ICH9M I/O Controller Hub (SATA 3.0Gb/s, USB 2.0, PCI Express® 1.1, PCI 2.3, ethernet MAC)	
ExpressCard/54 Multicard reader	One slot (ExpressCard/34, ExpressCard/54)	
Ports	6-in-1 reader (MultiMedia Card, Memory Stick, Memory Stick PRO™, Secure Digital Card, Secure Digital Elite Pro Card, xD-Picture Card™), Three USB 2.0, external monitor (VGA DB-15, HDMI), modem (RJ-11), ethernet (RJ-45), IEEE 1394 FireWire 400 (4-pin connector; 1394a-2000 standard)	
TV tuner	None	
Mini PCI Express	Two Mini PCI Express slots Intel 5100 ²⁸ 11a/b/g/n wireless ⁴ , Mini PCIe adapter, Intel WiFi Link 5100, 1x2 (Shirley Peak)	
Bluetooth™	None	
Modem	56K V.92 ⁶ modem	
Ethernet	10/100 ethernet, Broadcom® BCM5906M, PCI 2.3	
Audio support	High Definition (HD) Audio, Conexant 20561 codec / two main speakers (2 watt) and subwoofer (2.5 watt), Dolby® Home Theater™ Speaker System / dual array microphone, microphone input jack (3.5 mm), headphone jack (3.5 mm)	
Security	Power-on password, hard disk password, supervisor password, security lockhole, VeriFace face recognition software	
Fingerprint reader	None	

See footnotes for important warranty information * Intel Centrino® processor technology
 Ⓜ US model announced December 10, 2008; previous models on October 22 or November 12, 2008

Type-model	Processor	GHz	Memory	Widescreen display	CCFL or LED	Camera	Integrated graphics	SATA disk	SATA optical	Mini PCIe 802.11 wireless	Top color	ENERGY STAR 4.0	Vista preload	Avail date
2781-74U	T3200	2.00	2GB	14.1" WXGA		Cam	GMA	250GB ⁸	DVD±RW	Intel 5100 ²⁸	Black		Prem 32	Nov 08
2781-73U	T5800	2.00	3GB	14.1" WXGA		Cam	GMA	250GB	DVD±RW	* Intel 5100	Black	ES40	Prem 32	Sep 08
2781-7AU	T6400	2.00	4GB	14.1" WXGA	LED	Cam	GMA	250GB	DVD±RW	* Intel 5100	Black	ES40	Prem 64	Jan 09

- 14.1" widescreen, glossy display
- Light Weave textured cover
- Integrated 1.3 megapixel camera and Lenovo's VeriFace face recognition software helps control access to your notebook by recognizing your face.
- Dolby® Home Theater® premium audio system with two speakers and one subwoofer
- HDMI port, HDCP-compliant
- Lenovo Rescue System provides OneKey recovery and OneKey Antivirus without booting into Windows
- OneKey silence mode provides quieter operation through a touch-sensitive control button

Positioning Processor	Widescreen flexibility; two-spindle Intel® Pentium® dual-core processor T3200 with dual-core, 667MHz system bus, and 1MB L2 cache or Intel Core™ 2 Duo processor T5800 or T6400 with dual-core, 800MHz system bus, and 2MB L2 cache	Preloaded operating system²⁰ - Some: Microsoft® Windows® Vista® Home Premium Edition (32-bit) - Some: Microsoft® Windows® Vista® Home Premium Edition (64-bit) ♦ Vista Premium logo Preloaded applications¹⁴ (only some listed) • Lenovo™ OneKey Recovery • Lenovo ReadyComm • Norton Internet Security™ (90 days of virus definitions) • Adobe® Reader • Windows Live™ Toolbar • Easy Capture • Microsoft Office 2007 Trial (60-day) • WildGames™ • Carbonite Online Backup • VeriFace™ Facial Recognition • Lenovo Energy Management Software • Cyberlink Power2Go (DVD±RW) Available at these retailers • Circuit City® 65-watt AC adapter Wireless on/off switch Some: ENERGY STAR® 4.0-compliant RoHS-compliant Limited Warranty¹² ⇨ 1-year parts and labor ⇨ Depot repair service ¹⁹ ⇨ Service upgrade options (in eligible locations): ⁹ • 1-year accidental damage protection via depot 43R8885 • 3-year Lenovo Onsite Repair ¹³ 9x5 Next Business Day 43R8883 • 3-year Lenovo Onsite Repair ¹³ 9x5 Next Business Day with accidental damage protection 43R8884 ⇨ 24x7 ¹⁶ toll-free support for warranty issues during the warranty period ¹² via 877-453-6686
Memory	2GB or 3GB std / 4GB max ⁷ / PC2-5300 667MHz DDR2 , non-parity, dual-channel capable, two 200-pin SO-DIMM sockets; <i>Italics:</i> standard memory in both sockets; no sockets available	
Diskette drive	None (use optional USB-based diskette drive)	
SATA DVD±RW	DVD burner, dual-layer support, fixed, not removable, 12.7mm high, tray-in	
SATA disk	250GB (5400 rpm) / SATA 3.0Gb/s, 9.5mm high, removable	
Widescreen display	14.1" (358.1mm) WXGA (1280x800) TFT color, VibrantView (glossy), <i>Some:</i> CCFL backlight, 200 nits, 16:10 aspect ratio, 400:1 contrast ratio <i>Some:</i> LED backlight , 200 nits, 16:10 aspect ratio, 400:1 contrast ratio	
Camera	Camera on top of screen, 1.3-megapixel, fixed focus	
Integrated graphics	Intel Graphics Media Accelerator 4500MHD (GMA 4500MHD) , in GM45, HDMI port supporting HDCP to output protected content	
Keyboard	Full-size keyboard, 6-row, 84-key, multimedia Fn keys, recovery key	
Multimedia controls	Touch-sensitive audio-video control panel, Shuttle Key	
Touch pad	Two-button touch pad with scroll feature (no TrackPoint®)	
Dimensions ³	(<i>WxDxH</i>): 13.1" x 9.5" x 1.0" to 1.5"; 334mm x 241mm x 26 to 38mm	
Weight ²	with optical drive and battery: <i>6-cell</i> : 5.2 lb (2.35 kg)	
Case color	Black top, black bottom	
Case material	Polycarbonate/Acrylonitrile-Butadiene-Styrene (PC/ABS) plastic	
Battery - type	Lithium Ion 6-cell , 5200 mAh, smart battery	
Battery - life ¹⁰	Up to 5 hr	
Chipset	Mobile Intel GM45 Express Chipset (Memory Controller Hub), ICH9M I/O Controller Hub (SATA 3.0Gb/s, USB 2.0, PCI Express® 1.1, PCI 2.3, ethernet MAC)	
ExpressCard/54 Multicard reader	One slot (ExpressCard/34, ExpressCard/54)	
Ports	6-in-1 reader (MultiMedia Card, Memory Stick, Memory Stick PRO™, Secure Digital Card, Secure Digital Elite Pro Card, xD-Picture Card™) Three USB 2.0, external monitor (VGA DB-15, HDMI), modem (RJ-11), ethernet (RJ-45), IEEE 1394 FireWire 400 (4-pin connector; 1394a-2000 standard)	
TV tuner	None	
Mini PCI Express	Two Mini PCI Express slots Intel 5100 ²⁸ 11a/b/g/n wireless ⁴ , Mini PCIe adapter, Intel WiFi Link 5100, 1x2 (Shirley Peak)	
Bluetooth™	None	
Modem	56K V.92 ⁶ modem	
Ethernet	10/100 ethernet, Broadcom® BCM5906M, PCI 2.3	
Audio support	High Definition (HD) Audio, Conexant 20561 codec / two main speakers (2 watt) and subwoofer (2.5 watt), Dolby® Home Theater™ Speaker System / dual array microphone, microphone input jack (3.5 mm), headphone jack (3.5 mm)	
Security	Power-on password, hard disk password, supervisor password, security lockhole, VeriFace face recognition software	
Fingerprint reader	None	

See footnotes for important warranty information * Intel Centrino® processor technology
 Ⓢ US model announced January 13, 2008; previous models on September 9 or November 12, 2008



Lenovo IdeaPad Y510



Lenovo IdeaPad Y510
with aluminum palm rest



Lenovo IdeaPad Y510



Lenovo IdeaPad Y510
with aluminum palm rest



Lenovo IdeaPad Y510



Lenovo IdeaPad Y510

Part number	Processor	GHz	Memory	Widescreen display	Camera	Graphics controller	SATA disk	EIDE optical	Mini PCIe 802.11 wireless	Blue-tooth	Vista preload	Avail date
59012693	Pentium T2330	1.60	2GB	15.4" WXGA	Cam	GMA	160GB ⁸	DVD±RW	* Intel 11a/b/g ¹¹	None	Home Prem	Jan 08
59012889	Pentium T2330	1.60	2GB	15.4" WXGA	Cam	GMA	160GB	DVD±RW	* Intel 11a/b/g	None	Home Prem	Mar 08
59012696	Pentium T2330	1.60	2GB	15.4" WXGA	Cam	GMA	160GB	DVD±RW	* Intel 11a/b/g	None	Home Prem	Mar 08
59012697	Pentium T2330	1.60	2GB	15.4" WXGA	Cam	GMA	250GB	DVD±RW	* Intel 11a/b/g	None	Home Prem	Jan 08
59013478	Pentium T2370	1.73	2GB	15.4" WXGA	Cam	GMA	160GB	DVD±RW	* Intel 11a/b/g	None	Home Prem	Apr 08
59012698	Core 2 Duo T5450	1.66	2GB	15.4" WXGA	Cam	GMA	160GB	DVD±RW	* Intel 11a/b/g	None	Home Prem	Jan 08
59012924	Core 2 Duo T5450	1.66	2GB	15.4" WXGA	Cam	GMA	160GB	DVD±RW	* Intel 11a/b/g	None	Home Prem	Mar 08
59013046	Core 2 Duo T5450	1.66	2GB	15.4" WXGA	Cam	GMA	250GB	DVD±RW	* Intel 11n ²⁸	None	Home Prem	Mar 08
59012779	Core 2 Duo T5550	1.83	2GB	15.4" WXGA	Cam	GMA	250GB	DVD±RW	* Intel 11n	None	Home Prem	Jan 08
59012891	Core 2 Duo T5550	1.83	2GB	15.4" WXGA	Cam	GMA	250GB	DVD±RW	* Intel 11n	None	Home Prem	Mar 08
59013333	Core 2 Duo T5550	1.83	2GB	15.4" WXGA	Cam	GMA	250GB	DVD±RW	* Intel 11n	None	Home Prem	Mar 08
59013272	Core 2 Duo T8100	2.10	2GB	15.4" WXGA	Cam	GMA	250GB	DVD±RW	* Intel 11n	None	Home Prem	Mar 08

- 15.4" widescreen, glossy display
- Frameless screen (no plastic frame) to extend to the edges of the PC
- Light Weave textured cover
- Integrated 1.3 megapixel camera and Lenovo's VeriFace face recognition software helps control access to your notebook by recognizing your face.
- Dolby® Home Theater™ premium audio system with four speakers and one subwoofer
- Shuttle Center offers a one-stop, total entertainment environment with Shuttle Key that puts volume and equalizer controls on the keyboard
- One key system recovery

Positioning Processor	Widescreen flexibility; two-spindle Intel® Pentium® Dual-Core Processor T2330 or T2370 with dual-core, Intel 64 Technology, Enhanced Intel SpeedStep™ technology ¹ , Execute Disable Bit, 533MHz system bus, and 1MB L2 cache or Intel Core™ 2 Duo processor T5450 or T5550 with dual-core, Intel 64 Technology, Enhanced Intel SpeedStep technology, Execute Disable Bit, 667MHz system bus, and 2MB L2 cache or Intel Core 2 Duo processor T8100 with dual-core, Intel 64 Technology, Enhanced Intel SpeedStep technology, Intel Dynamic Acceleration, Execute Disable Bit, Virtualization Technology, 800MHz system bus, and 3MB L2 cache	Preloaded operating system ²⁰ - Microsoft® Windows® Vista® Home Premium Edition (32-bit) ◇ Vista Premium logo Preloaded applications ¹⁴ • Lenovo™ OneKey Recovery • Lenovo Anycomm • Norton® AntiVirus 2007 (90 days of virus definitions) • Adobe® Reader • Windows Live™ Toolbar • Easy Capture • Microsoft Office 2007 Trial (60-day) • VeriFace™ Facial Recognition • EarthLink® • Energy Cut • Lenovo ShuttleCenter (DVD±RW) • Cyberlink Power2Go (DVD±RW)
Memory	2GB std / 4GB max ⁷ / PC2-5300 667MHz DDR2, non-parity, dual-channel capable, two 200-pin SO-DIMM sockets; <i>Italics:</i> standard memory in both sockets; no sockets available	
Diskette drive EIDE DVD±RW SATA disk	None (use optional USB-based diskette drive) DVD burner, dual-layer support, fixed, not removable, 12.7mm high, tray-in 160GB (5400 rpm) or 250GB (5400 rpm) / SATA 1.5Gb/s, 9.5mm high, removable	
Widescreen display Camera	15.4" (391.2mm) WXGA (1280x800) TFT color, VibrantView (glossy), CCFL backlight, 200 nits, 16:10 aspect ratio, 400:1 contrast ratio, frameless screen Camera on top of screen, 1.3-megapixel, fixed focus	
Graphics	Intel Graphics Media Accelerator X3100, in GM965	
Keyboard Multimedia controls Touch pad	Full-size keyboard, 6-row, 84-key, multimedia Fn keys Touch-sensitive audio-video control panel, Shuttle Key Two-button touch pad with scroll feature (no TrackPoint®)	
Dimensions ³ Weight ² Case color Case material Battery - type Battery - life ¹⁰	(WxDxH): 14.2" x 10.3" x 1.2" to 1.4"; 360mm x 262mm x 29 to 36mm with optical drive and battery: 6-cell: 6.4 lb (2.91 kg) Black top, black bottom ABS plastic Lithium Ion 6-cell, 5200 mAh, smart battery, 5-bar battery indicator Up to 4 hr	Available at these retailers • B&H™ • BJ's SM • J&R™ • MICROCENTER® • Newegg® • Office DEPOT® • RCSEXPERIENCE • TigerDirect
Chipset	Mobile Intel GM965 Express Chipset (Graphics Memory Controller Hub); ICH8M I/O Controller Hub (SATA 3.0Gb/s, ATA-100 EIDE, USB 2.0, PCI Express® 1.1, PCI 2.3), LPC bus	
ExpressCard/54 Multicard reader	One slot (ExpressCard/34, ExpressCard/54) 6-in-1 reader (MultiMedia Card, Memory Stick, Memory Stick PRO™, Secure Digital Card, Secure Digital Elite Pro Card, xD-Picture Card™)	65-watt AC adapter Wireless on/off switch ENERGY STAR® 4.0-compliant RoHS-compliant
Ports	Three USB 2.0, external monitor (VGA DB-15), S-video, modem (RJ-11), ethernet (RJ-45), IEEE 1394 FireWire 400 (4-pin connector; 1394a-2000 standard)	
TV tuner Video out Mini PCI Express Intel 11a/b/g Intel 11n	None S-video out port (TV-out), one 7-pin industry standard connector Two Mini PCI Express slot 11a/b/g wireless ⁴ , Mini PCI Express adapter, Intel PRO/Wireless 3945ABG 11a/b/g/n wireless, Mini PCIe adapter, Intel Wireless WiFi Link 4965AGN, MIMO 2x3 (Kedron)	Limited Warranty¹² ⇨ 1-year parts and labor ⇨ Depot repair service ¹⁹ ⇨ Service upgrade options (in eligible locations): ⁹ • 1-year accidental damage protection via depot 43R8885 • 3-year Lenovo Onsite Repair ¹³ 9x5 Next Business Day 43R8883 • 3-year Lenovo Onsite Repair ¹³ 9x5 Next Business Day with accidental damage protection 43R8884 ⇨ 24x7 ¹⁶ toll-free support for warranty issues during the warranty period ¹² via 877-453-6686
Bluetooth™ Modem Ethernet Audio support	None 56K V.92 ⁶ modem 10/100 ethernet, Broadcom® BCM5906M, PCI 2.3 Intel High Definition (HD) Audio, RealTek® ALC882 codec / two main speakers (2 watt), two secondary speaker (1 watt) and subwoofer (2.5 watt), Dolby® Home Theater™ Speaker System / stereo microphone, microphone input jack (3.5 mm), stereo headphone jack (3.5 mm)	
Security	Power-on password, hard disk password, supervisor password, security lockhole, VeriFace face recognition software	
Fingerprint reader	None	

See footnotes for important warranty information * Intel Centrino® processor technology
⁸ US model announced April 15, 2008; previous models on January 6 or March 25, 2008

Part number	Processor	GHz	Memory	Widescreen display	Camera	Graphics controller	SATA disk	EIDE optical	Mini PCIe 802.11 wireless	Blue-tooth	Vista preload	Avail date
59014835	Pentium T2390	1.86	2GB	15.4" WXGA	Cam	GMA	120GB ⁸	DVD±RW	Intel 4965AG ¹¹	None	Home Prem	Aug08
59014810	Pentium T2390	1.86	2GB	15.4" WXGA	Cam	GMA	160GB	DVD±RW	Intel 4965AG	None	Home Prem	Jul 08
59014900	Pentium T2390	1.86	2GB	15.4" WXGA	Cam	GMA	160GB	DVD±RW	Intel 4965AG	None	Home Prem	Jul 08
59014632	Pentium T2390	1.86	3GB	15.4" WXGA	Cam	GMA	160GB	DVD±RW	Intel 4965AG	None	Home Prem	Jul 08
59014807	Pentium T2390	1.86	3GB	15.4" WXGA	Cam	GMA	250GB	DVD±RW	Intel 4965AG	None	Home Prem	Jul 08
59014834	Core 2 Duo T5750	2.00	2GB	15.4" WXGA	Cam	GMA	250GB	DVD±RW	* Intel 4965AG	None	Home Prem	Aug08
59014491	Core 2 Duo T5750	2.00	2GB	15.4" WXGA	Cam	GMA	250GB	DVD±RW	* Intel 4965AG	None	Home Prem	Jul 08
59014899	Core 2 Duo T5750	2.00	2GB	15.4" WXGA	Cam	GMA	250GB	DVD±RW	* Intel 4965AG	None	Home Prem	Jul 08
59015479	Core 2 Duo T5750	2.00	3GB	15.4" WXGA	Cam	GMA	250GB	DVD±RW	* Intel 11a/b/g ¹¹	None	Home Prem	Sep08
59014866	Core 2 Duo T5750	2.00	3GB	15.4" WXGA	Cam	GMA	250GB	DVD±RW	* Intel 4965AG	None	Home Prem	Sep08
59014867	Core 2 Duo T5750	2.00	3GB	15.4" WXGA	Cam	GMA	250GB	DVD±RW	* Intel 4965AG	None	Home Prem	Jul 08
59014898	Core 2 Duo T5750	2.00	3GB	15.4" WXGA	Cam	GMA	250GB	DVD±RW	* Intel 4965AG	None	Home Prem	Jul 08
59014633	Core 2 Duo T5750	2.00	3GB	15.4" WXGA	Cam	GMA	250GB	DVD±RW	* Intel 4965AG	None	Home Prem	Sep08
59014903	Core 2 Duo T5750	2.00	3GB	15.4" WXGA	Cam	GMA	320GB	DVD±RW	* Intel 4965AG	None	Home Prem	Jul 08

- 15.4" widescreen, glossy display
- Light Weave textured cover
- Integrated 1.3 megapixel camera and Lenovo's VeriFace face recognition software helps control access to your notebook by recognizing your face.
- Dolby® Home Theater™ premium audio system with four speakers and one subwoofer
- Shuttle Center offers a one-stop, total entertainment environment with Shuttle Key that puts volume and equalizer controls on the keyboard
- One key system recovery

Positioning Processor	Widescreen flexibility; two-spindle Intel® Pentium® Dual-Core Processor T2390 with dual-core, Intel 64 Technology, Enhanced Intel SpeedStep™ technology ¹ , Execute Disable Bit, 533MHz system bus, and 1MB L2 cache or Intel Core™ 2 Duo processor T5750 with dual-core, Intel 64 Technology, Enhanced Intel SpeedStep technology, Execute Disable Bit, 667MHz system bus, and 2MB L2 cache	Preloaded operating system ²⁰ - Microsoft® Windows® Vista® Home Premium Edition (32-bit) ♦ Vista Premium logo Preloaded applications ¹⁴ • Lenovo™ OneKey Recovery • Lenovo Anycomm • Norton® AntiVirus 2007 (90 days of virus definitions) • Adobe® Reader • Windows Live™ Toolbar • Easy Capture • Microsoft Office 2007 Trial (60-day) • VeriFace™ Facial Recognition • EarthLink® • Energy Cut • Lenovo Shuttle Center (DVD±RW) • Cyberlink Power2Go (DVD±RW)
Memory	2GB or 3GB std / 4GB max ⁷ / PC2-5300 667MHz DDR2 , non-parity, dual-channel capable, two 200-pin SO-DIMM sockets; <i>Italics:</i> standard memory in both sockets; no sockets available	
Diskette drive	None (use optional USB-based diskette drive)	
EIDE DVD±RW	DVD burner, dual-layer support, fixed, not removable, 12.7mm high, tray-in	
SATA disk	120GB (5400 rpm), 160GB (5400 rpm), 250GB (5400 rpm), or 320GB (5400 rpm) / SATA 1.5Gb/s, 9.5mm high, removable	
Widescreen display	15.4" (391.2mm) WXGA (1280x800) TFT color, VibrantView (glossy), CCFL backlight, 200 nits, 16:10 aspect ratio, 400:1 contrast ratio	
Camera	Camera on top of screen, 1.3-megapixel, fixed focus	
Graphics	Intel Graphics Media Accelerator X3100 , in GM965	
Keyboard	Full-size keyboard, 6-row, 84-key, multimedia Fn keys	
Multimedia controls	Touch-sensitive audio-video control panel, Shuttle Key	
Touch pad	Two-button touch pad with scroll feature (no TrackPoint®)	
Dimensions ³	(WxDxH): 14.2" x 10.3" x 1.2" to 1.4"; 360mm x 262mm x 29 to 36mm	Available at these retailers • B&H™ • MICROCENTER® • Newegg® • TigerDirect • The Source (Canada)
Weight ²	with optical drive and battery: <i>6-cell</i> : 6.4 lb (2.91 kg)	
Case color	Black top, black bottom	
Case material	ABS plastic	
Battery - type	Lithium Ion 6-cell , 5200 mAh, smart battery, 5-bar battery indicator	
Battery - life ¹⁰	Up to 4 hr	
Chipset	Mobile Intel GM965 Express Chipset (Graphics Memory Controller Hub); ICH8M I/O Controller Hub (SATA 3.0Gb/s, ATA-100 EIDE, USB 2.0, PCI Express® 1.1, PCI 2.3), LPC bus	
ExpressCard/54	One slot (ExpressCard/34, ExpressCard/54)	
Multicard reader	6-in-1 reader (MultiMedia Card, Memory Stick, Memory Stick PRO™, Secure Digital Card, Secure Digital Elite Pro Card, xD-Picture Card™)	
Ports	Three USB 2.0, external monitor (VGA DB-15), S-video, modem (RJ-11), ethernet (RJ-45), IEEE 1394 FireWire 400 (4-pin connector; 1394a-2000 standard)	
TV tuner	None	Limited Warranty ¹² ⇨ 1-year parts and labor ⇨ Depot repair service ¹⁹ ⇨ Service upgrade options (in eligible locations): ⁹ • 1-year accidental damage protection via depot 43R8885 • 3-year Lenovo Onsite Repair ¹³ 9x5 Next Business Day 43R8883 • 3-year Lenovo Onsite Repair ¹³ 9x5 Next Business Day with accidental damage protection 43R8884 ⇨ 24x7¹⁶ toll-free support for warranty issues during the warranty period ¹² via 877-453-6686
Video out	S-video out port (TV-out), one 7-pin industry standard connector	
Mini PCI Express	Two Mini PCI Express slot	
Intel 11a/b/g	<i>Some:</i> 11a/b/g wireless ⁴ , Mini PCI Express adapter, Intel PRO/Wireless 3945ABG	
Intel 4965AG	<i>Some:</i> 11a/b/g wireless, Mini PCIe adapter, Intel Wireless WiFi Link 4965AG	
Bluetooth™	None	
Modem	56K V.92 ⁶ modem	
Ethernet	10/100 ethernet, Broadcom® BCM5906M, PCI 2.3	
Audio support	Intel High Definition (HD) Audio, RealTek® ALC882 codec / two main speakers (2 watt), two secondary speaker (1 watt) and subwoofer (2.5 watt), Dolby® Home Theater™ Speaker System / stereo microphone, microphone input jack (3.5 mm), stereo headphone jack (3.5 mm)	
Security	Power-on password, hard disk password, supervisor password, security lockhole, VeriFace face recognition software	
Fingerprint reader	None	

See footnotes for important warranty information * Intel Centrino® processor technology
 Ⓢ US models announced September 30, 2008; previous models on July 15 or September 9, 2008

Part number	Processor	GHz	Memory	Widescreen display	Camera	Graphics controller	SATA disk	EIDE optical	Mini PCIe 802.11 wireless	Blue-tooth	Vista preload	Avail date
59013791	Pentium T2370	1.73	2GB	15.4" WXGA	Cam	GMA	160GB ⁸	DVD±RW	* Intel 11a/b/g ¹¹	None	Home Prem	May 08
59013613	Pentium T2370	1.73	3GB	15.4" WXGA	Cam	GMA	160GB	DVD±RW	* Intel 11a/b/g	None	Home Prem	May 08
59013769	Pentium T2370	1.73	3GB	15.4" WXGA	Cam	GMA	250GB	DVD±RW	* Intel 11a/b/g	None	Home Prem	May 08
59013615	Core 2 Duo T5550	1.83	3GB	15.4" WXGA	Cam	GMA	250GB	DVD±RW	* Intel 11n ²⁸	None	Home Prem	May 08
59013765	Core 2 Duo T5550	1.83	3GB	15.4" WXGA	Cam	GMA	250GB	DVD±RW	* Intel 11n	None	Home Prem	May 08
59013885	Core 2 Duo T5550	1.83	3GB	15.4" WXGA	Cam	GMA	160GB	DVD±RW	* Intel 11a/b/g	None	Home Prem	May 08
59014491	Core 2 Duo T5750	2.00	2GB	15.4" WXGA	Cam	GMA	250GB	DVD±RW	* Intel 4965AG	None	Home Prem	Jun 08
59013782	Core 2 Duo T8100	2.10	2GB	15.4" WXGA	Cam	GMA	250GB	DVD±RW	* Intel 11n	None	Home Prem	May 08

- 15.4" widescreen, glossy display
- Frameless screen (no plastic frame) to extend to the edges of the PC
- Light Weave textured cover
- Integrated 1.3 megapixel camera and Lenovo's VeriFace face recognition software helps control access to your notebook by recognizing your face.
- Dolby® Home Theater™ premium audio system with four speakers and one subwoofer
- Shuttle Center offers a one-stop, total entertainment environment with Shuttle Key that puts volume and equalizer controls on the keyboard
- One key system recovery

Positioning Processor	Widescreen flexibility; two-spindle Intel® Pentium® Dual-Core Processor T2370 with dual-core, Intel 64 Technology, Enhanced Intel SpeedStep™ technology ¹ , Execute Disable Bit, 533MHz system bus, and 1MB L2 cache or Intel Core™ 2 Duo processor T5550 or T5750 with dual-core, Intel 64 Technology, Enhanced Intel SpeedStep technology, Execute Disable Bit, 667MHz system bus, and 2MB L2 cache or Intel Core 2 Duo processor T8100 with dual-core, Intel 64 Technology, Enhanced Intel SpeedStep technology, Intel Dynamic Acceleration, Execute Disable Bit, Virtualization Technology, 800MHz system bus, and 3MB L2 cache	Preloaded operating system ²⁰ - Microsoft® Windows® Vista® Home Premium Edition (32-bit) ◇ Vista Premium logo Preloaded applications ¹⁴ • Lenovo™ OneKey Recovery • Lenovo Anycomm • Norton® AntiVirus 2007 (90 days of virus definitions) • Adobe® Reader • Windows Live™ Toolbar • Easy Capture • Microsoft Office 2007 Trial (60-day) • VeriFace™ Facial Recognition • EarthLink® • Energy Cut • Lenovo ShuttleCenter (DVD±RW) • Cyberlink Power2Go (DVD±RW)
Memory	2GB or 3GB std / 4GB max ⁷ / PC2-5300 667MHz DDR2, non-parity, dual-channel capable, two 200-pin SO-DIMM sockets; <i>Italics:</i> standard memory in both sockets; no sockets available	
Diskette drive EIDE DVD±RW SATA disk	None (use optional USB-based diskette drive) DVD burner, dual-layer support, fixed, not removable, 12.7mm high, tray-in 160GB (5400 rpm) or 250GB (5400 rpm) / SATA 1.5Gb/s, 9.5mm high, removable	
Widescreen display Camera	15.4" (391.2mm) WXGA (1280x800) TFT color, VibrantView (glossy), CCFL backlight, 200 nits, 16:10 aspect ratio, 300:1 contrast ratio, frameless screen Camera on top of screen, 1.3-megapixel, fixed focus	
Graphics	Intel Graphics Media Accelerator X3100, in GM965	
Keyboard Multimedia controls Touch pad	Full-size keyboard, 6-row, 84-key, multimedia Fn keys Touch-sensitive audio-video control panel, Shuttle Key Two-button touch pad with scroll feature (no TrackPoint®)	
Dimensions ³ Weight ² Case color Case material Battery - type Battery - life ¹⁰	(WxDxH): 14.2" x 10.3" x 1.2" to 1.4"; 360mm x 262mm x 29 to 36mm with optical drive and battery: 6-cell: 6.4 lb (2.91 kg) Black top, black bottom ABS plastic Lithium Ion 6-cell, 5200 mAh, smart battery, 5-bar battery indicator Up to 4 hr	Available at these retailers • B&H™ • BJ's SM • J&R™ • MICROCENTER® • Newegg® • Office DEPOT® • RCSEXPERIENCE • TigerDirect
Chipset	Mobile Intel GM965 Express Chipset (Graphics Memory Controller Hub); ICH8M I/O Controller Hub (SATA 3.0Gb/s, ATA-100 EIDE, USB 2.0, PCI Express® 1.1, PCI 2.3), LPC bus	
ExpressCard/54 Multicard reader	One slot (ExpressCard/34, ExpressCard/54) 6-in-1 reader (MultiMedia Card, Memory Stick, Memory Stick PRO™, Secure Digital Card, Secure Digital Elite Pro Card, xD-Picture Card™)	65-watt AC adapter Wireless on/off switch ENERGY STAR® 4.0-compliant RoHS-compliant
Ports	Three USB 2.0, external monitor (VGA DB-15), S-video, modem (RJ-11), ethernet (RJ-45), IEEE 1394 FireWire 400 (4-pin connector; 1394a-2000 standard)	
TV tuner Video out Mini PCI Express Intel 11a/b/g Intel 4965AG Intel 11n	None S-video out port (TV-out), one 7-pin industry standard connector Two Mini PCI Express slot <i>Some:</i> 11a/b/g wireless ⁴ , Mini PCI Express adapter, Intel PRO/Wireless 3945ABG <i>Some:</i> 11a/b/g wireless, Mini PCIe adapter, Intel Wireless WiFi Link 4965AG <i>Some:</i> 11a/b/g/n wireless, Mini PCIe adapter, Intel Wireless WiFi Link 4965AGN, MIMO 2x3 (Kedron)	Limited Warranty ¹² ⇒ 1-year parts and labor ⇒ Depot repair service ¹⁹ ⇒ Service upgrade options (in eligible locations): ⁹ • 1-year accidental damage protection via depot 43R8885 • 3-year Lenovo Onsite Repair ¹³ 9x5 Next Business Day 43R8883 • 3-year Lenovo Onsite Repair ¹³ 9x5 Next Business Day with accidental damage protection 43R8884 ⇒ 24x7 ¹⁶ toll-free support for warranty issues during the warranty period ¹² via 877-453-6686
Bluetooth™ Modem Ethernet Audio support	None 56K V.92 ⁶ modem 10/100 ethernet, Broadcom® BCM5906M, PCI 2.3 Intel High Definition (HD) Audio, RealTek® ALC882 codec / two main speakers (2 watt), two secondary speaker (1 watt) and subwoofer (2.5 watt), Dolby® Home Theater™ Speaker System / stereo microphone, microphone input jack (3.5 mm), stereo headphone jack (3.5 mm)	
Security	Power-on password, hard disk password, supervisor password, security lockhole, VeriFace face recognition software	
Fingerprint reader	None	

See footnotes for important warranty information * Intel Centrino® processor technology
 Ⓜ US model announced June 27, 2008; previous models on May 12, 2008

Part number	Processor	GHz	Memory	Widescreen display	Camera	Graphics controller	SATA disk	EIDE optical	Mini PCIe 802.11 wireless	Blue-tooth	Vista preload	Avail date
59013678	Core 2 Duo T5550	1.83	2GB	15.4" WXGA	Cam	8600M GT	160GB ⁸	DVD±RW	* Intel 11n ²⁸	Blue	Home Prem	May 08
59013679	Core 2 Duo T5550	1.83	2GB	15.4" WXGA	Cam	8600M GT	250GB	DVD±RW	* Intel 11n	Blue	Home Prem	May 08
59013680	Core 2 Duo T5550	1.83	4GB	15.4" WXGA	Cam	8600M GT	250GB	DVD±RW	* Intel 11n	Blue	Home Prem	May 08
59013779	Core 2 Duo T5550	1.83	4GB	15.4" WXGA	Cam	8600M GT	250GB	DVD±RW	* Intel 11n	Blue	Home Prem	May 08

- 15.4" widescreen, glossy display
- Frameless screen (no plastic frame) to extend to the edges of the PC
- Light Weave textured cover
- Integrated 1.3 megapixel camera and Lenovo's VeriFace face recognition software helps control access to your notebook by recognizing your face.
- Dolby® Home Theater™ premium audio system with four speakers and one subwoofer
- Shuttle Center offers a one-stop, total entertainment environment with Shuttle Key that puts volume and equalizer controls on the keyboard
- One key system recovery

Positioning Processor	Widescreen flexibility; two-spindle Intel® Core™ 2 Duo processor T5550 with dual-core, Intel 64 Technology, Enhanced Intel SpeedStep™ technology ¹ , Execute Disable Bit, 667MHz system bus, and 2MB L2 cache	Preloaded operating system ²⁰ - Microsoft® Windows® Vista® Home Premium Edition (32-bit) ◇ Vista Premium logo
Memory	2GB or 4GB std / 4GB max ⁷ / PC2-5300 667MHz DDR2, non-parity, dual-channel capable, two 200-pin SO-DIMM sockets; <i>Italics:</i> standard memory in both sockets; no sockets available	Preloaded applications ¹⁴ • Lenovo™ OneKey Recovery • Lenovo Anycomm • Norton® AntiVirus 2007 (90 days of virus definitions) • Adobe® Reader • Windows Live™ Toolbar • Easy Capture • Microsoft Office 2007 Trial (60-day) • VeriFace™ Facial Recognition • EarthLink® • Energy Cut • Lenovo Shuttle Center (DVD±RW) • Cyberlink Power2Go (DVD±RW)
Diskette drive	None (use optional USB-based diskette drive)	Available at these retailers • B&H™ • BJ's SM • J&R™ • MICROCENTER® • Newegg® • Office DEPOT® • RCSEXPERIENCE • TigerDirect
EIDE DVD±RW	DVD burner, dual-layer support, fixed, not removable, 12.7mm high, tray-in	
SATA disk	160GB (5400 rpm) or 250GB (5400 rpm) / SATA 1.5Gb/s, 9.5mm high, removable	
Widescreen display	15.4" (391.2mm) WXGA (1280x800) TFT color, VibrantView (glossy), CCFL backlight, 200 nits, 16:10 aspect ratio, 300:1 contrast ratio, frameless screen	
Camera	Camera on top of screen, 1.3-megapixel, fixed focus	
Graphics	NVIDIA® GeForce® 8600M GT, PCI Express® x16, 256MB memory, DirectX® 10, TurboCache, PureVideo™ technology, VGA connector, S-video connector	
Keyboard	Full-size keyboard, 6-row, 84-key, multimedia Fn keys	
Multimedia controls	Touch-sensitive audio-video control panel, Shuttle Key	
Touch pad	Two-button touch pad with scroll feature (no TrackPoint®)	
Dimensions ³	(WxDxH): 14.2" x 10.3" x 1.2" to 1.4"; 360mm x 262mm x 29 to 36mm	
Weight ²	with optical drive and battery: 6-cell: 6.4 lb (2.91 kg)	
Case color	Black top, black bottom	
Case material	ABS plastic; <i>Palm rest:</i> aluminum	
Battery - type	Lithium Ion 6-cell, 5200 mAh, smart battery, 5-bar battery indicator	
Battery - life ¹⁰	Up to 3 hr	
Chipset	Mobile Intel GM965 Express Chipset (Graphics Memory Controller Hub); ICH8M I/O Controller Hub (SATA 3.0Gb/s, ATA-100 EIDE, USB 2.0, PCI Express 1.1, PCI 2.3), LPC bus	90-watt AC adapter Wireless on/off switch ENERGY STAR® 4.0-compliant RoHS-compliant
ExpressCard/54	One slot (ExpressCard/34, ExpressCard/54)	Limited Warranty¹² ⇨ 1-year parts and labor ⇨ Depot repair service ¹⁹ ⇨ Service upgrade options (in eligible locations): ⁹ • 1-year accidental damage protection via depot 43R8885 • 3-year Lenovo Onsite Repair ¹³ 9x5 Next Business Day 43R8883 • 3-year Lenovo Onsite Repair ¹³ 9x5 Next Business Day with accidental damage protection 43R8884 ⇨ 24x7 ¹⁶ toll-free support for warranty issues during the warranty period ¹² via 877-453-6686
Multicard reader	6-in-1 reader (MultiMedia Card, Memory Stick, Memory Stick PRO™, Secure Digital Card, Secure Digital Elite Pro Card, xD-Picture Card™)	
Ports	Three USB 2.0, external monitor (VGA DB-15), S-video, modem (RJ-11), ethernet (RJ-45), IEEE 1394 FireWire 400 (4-pin connector; 1394a-2000 standard)	
TV tuner	None	
Video out	S-video out port (TV-out), one 7-pin industry standard connector	
Mini PCI Express	Two Mini PCI Express slot	
Intel 11a/b/g	11a/b/g wireless ⁴ , Mini PCI Express adapter, Intel PRO/Wireless 3945ABG	
Intel 11n	11a/b/g/n wireless, Mini PCIe adapter, Intel Wireless WiFi Link 4965AGN, MIMO 2x3 (Kedron)	
Bluetooth™	Bluetooth 2.0 wireless, USB 2.0 interface via ICH8M, LED indicator	
Modem	56K V.92 ⁶ modem	
Ethernet	10/100 ethernet, Broadcom® BCM5906M, PCI 2.3	
Audio support	Intel High Definition (HD) Audio, RealTek® ALC882 codec / two main speakers (2 watt), two secondary speaker (1 watt) and subwoofer (2.5 watt), Dolby® Home Theater™ Speaker System / stereo microphone, microphone input jack (3.5 mm), stereo headphone jack (3.5 mm)	
Security	Power-on password, hard disk password, supervisor password, security lockhole, VeriFace face recognition software	
Fingerprint reader	None	

See footnotes for important warranty information
US models announced May 12, 2008

* Intel Centrino® processor technology

© Lenovo
(MKL1-3) May 2008

Type-model	Processor	GHz	Memory	Widescreen display	Camera	Graphics controller	SATA disk	EIDE optical	Mini PCIe 802.11 wireless	Blue-tooth	Vista preload	Avail date
7758-2AU	Pentium T2370	1.73	2GB	15.4" WXGA	Cam	GMA	120GB ⁸	DVD±RW	Intel 11a/b/g ¹¹	None	Home Prem	May 08
7758-2BU	Pentium T2370	1.73	2GB	15.4" WXGA	Cam	GMA	160GB	DVD±RW	Intel 11a/b/g	None	Home Prem	May 08
7758-2CU	Core 2 Duo T5550	1.83	2GB	15.4" WXGA	Cam	GMA	160GB	DVD±RW	* Intel 11a/b/g	None	Home Prem	May 08
7758-3AU	Pentium T2390	1.86	2GB	15.4" WXGA	Cam	GMA	160GB	DVD±RW	Intel 11a/b/g	None	Home Prem	Aug 08
7758-3BU	Pentium T2390	1.86	2GB	15.4" WXGA	Cam	GMA	250GB	DVD±RW	Intel 11a/b/g	None	Home Prem	Aug 08
7758-3CU	Core 2 Duo T5750	2.00	2GB	15.4" WXGA	Cam	GMA	250GB	DVD±RW	* Intel 11a/b/g	None	Home Prem	Aug 08

- 15.4" widescreen, glossy display
- Frameless screen (no plastic frame) to extend to the edges of the PC
- Light Weave textured cover
- Integrated 1.3 megapixel camera and Lenovo's VeriFace face recognition software helps control access to your notebook by recognizing your face.
- Dolby® Home Theater™ premium audio system with four speakers and one subwoofer
- Shuttle Center offers a one-stop, total entertainment environment with Shuttle Key that puts volume and equalizer controls on the keyboard
- One key system recovery

Positioning Processor	Widescreen flexibility; two-spindle Intel® Pentium® Dual-Core Processor T2370 or T2390 with dual-core, Intel 64 Technology, Enhanced Intel SpeedStep™ technology ¹ , Execute Disable Bit, 533MHz system bus, and 1MB L2 cache or Intel Core™ 2 Duo processor T5550 or T5750 with dual-core, Intel 64 Technology, Enhanced Intel SpeedStep technology, Execute Disable Bit, 667MHz system bus, and 2MB L2 cache	Preloaded operating system ²⁰ - Microsoft® Windows® Vista® Home Premium Edition (32-bit) ◇ Vista Premium logo Preloaded applications ¹⁴ • Lenovo™ OneKey Recovery • Lenovo Anycomm • Norton® AntiVirus 2007 (90 days of virus definitions) • Adobe® Reader • Windows Live™ Toolbar • Easy Capture • Microsoft Office 2007 Trial (60-day) • VeriFace™ Facial Recognition • EarthLink® • Energy Cut • Lenovo Shuttle Center (DVD±RW) • Cyberlink Power2Go (DVD±RW)
Memory	2GB std / 4GB max ⁷ / PC2-5300 667MHz DDR2, non-parity, dual-channel capable, two 200-pin SO-DIMM sockets; <i>Italics:</i> standard memory in both sockets; no sockets available	
Diskette drive EIDE DVD±RW SATA disk	None (use optional USB-based diskette drive) DVD burner, dual-layer support, fixed, not removable, 12.7mm high, tray-in 120GB (5400 rpm), 160GB (5400 rpm), or 250GB (5400 rpm) / SATA 1.5Gb/s, 9.5mm high, removable	
Widescreen display Camera	15.4" (391.2mm) WXGA (1280x800) TFT color, VibrantView (glossy), CCFL backlight, 200 nits, 16:10 aspect ratio, 300:1 contrast ratio, frameless screen Camera on top of screen, 1.3-megapixel, fixed focus	
Graphics	Intel Graphics Media Accelerator X3100, in GM965	
Keyboard Multimedia controls Touch pad	Full-size keyboard, 6-row, 84-key, multimedia Fn keys Touch-sensitive audio-video control panel, Shuttle Key Two-button touch pad with scroll feature (no TrackPoint®)	
Dimensions ³ Weight ² Case color Case material Battery - type Battery - life ¹⁰	(WxDxH): 14.2" x 10.3" x 1.2" to 1.4"; 360mm x 262mm x 29 to 36mm with optical drive and battery: 6-cell: 6.4 lb (2.91 kg) Black top, black bottom ABS plastic Lithium Ion 6-cell, 5200 mAh, smart battery, 5-bar battery indicator Up to 4 hr	Available at these retailers • lenovo.com
Chipset	Mobile Intel GM965 Express Chipset (Graphics Memory Controller Hub); ICH8M I/O Controller Hub (SATA 3.0Gb/s, ATA-100 EIDE, USB 2.0, PCI Express® 1.1, PCI 2.3), LPC bus	65-watt AC adapter Wireless on/off switch ENERGY STAR® 4.0-compliant RoHS-compliant
ExpressCard/54 Multicard reader	One slot (ExpressCard/34, ExpressCard/54) 6-in-1 reader (MultiMedia Card, Memory Stick, Memory Stick PRO™, Secure Digital Card, Secure Digital Elite Pro Card, xD-Picture Card™)	Limited Warranty¹² ⇨ 1-year parts and labor ⇨ Depot repair service ¹⁹ ⇨ Service upgrade options (in eligible locations): ⁹ • 1-year accidental damage protection via depot 43R8885 • 3-year Lenovo Onsite Repair ¹³ 9x5 Next Business Day 43R8883 • 3-year Lenovo Onsite Repair ¹³ 9x5 Next Business Day with accidental damage protection 43R8884 ⇨ 24x7 ¹⁶ toll-free support for warranty issues during the warranty period ¹² via 877-453-6686
Ports	Three USB 2.0, external monitor (VGA DB-15), S-video, modem (RJ-11), ethernet (RJ-45), IEEE 1394 FireWire 400 (4-pin connector; 1394a-2000 standard)	
TV tuner Video out Mini PCI Express Intel 11a/b/g Bluetooth™ Modem Ethernet Audio support	None S-video out port (TV-out), one 7-pin industry standard connector Two Mini PCI Express slot 11a/b/g wireless ⁴ , Mini PCI Express adapter, Intel PRO/Wireless 3945ABG None 56K V.92 ⁶ modem 10/100 ethernet, Broadcom® BCM5906M, PCI 2.3 Intel High Definition (HD) Audio, RealTek® ALC882 codec / two main speakers (2 watt), two secondary speaker (1 watt) and subwoofer (2.5 watt), Dolby® Home Theater™ Speaker System / stereo microphone, microphone input jack (3.5 mm), stereo headphone jack (3.5 mm)	
Security Fingerprint reader	Power-on password, hard disk password, supervisor password, security lockhole, VeriFace face recognition software None	

See footnotes for important warranty information * Intel Centrino® processor technology
 ⚡ US models announced August 5, 2008; previous models on April 29, 2008

Type-model	Processor	GHz	Memory	Widescreen display	Camera	Graphics controller	SATA disk	EIDE optical	Mini PCIe 802.11 wireless	Blue-tooth	Vista preload	Avail date
7758-2DU	Core 2 Duo T5550	1.83	2GB	15.4" WXGA	Cam	8600M GT	160GB ⁸	DVD±RW	* Intel 11n ²⁸	Blue	Home Prem	May 08
7758-2EU	Core 2 Duo T5550	1.83	2GB	15.4" WXGA	Cam	8600M GT	250GB	DVD±RW	* Intel 11n	Blue	Home Prem	May 08
7758-2FU	Core 2 Duo T5550	1.83	4GB	15.4" WXGA	Cam	8600M GT	250GB	DVD±RW	* Intel 11n	Blue	Home Prem	May 08
7758-3DU	Core 2 Duo T5750	2.00	2GB	15.4" WXGA	Cam	8600M GT	250GB	DVD±RW	* Intel 11n	Blue	Home Prem	Aug 08
7758-3EU	Core 2 Duo T5750	2.00	2GB	15.4" WXGA	Cam	8600M GT	320GB	DVD±RW	* Intel 11n	Blue	Home Prem	Aug 08
7758-3FU	Core 2 Duo T5750	2.00	4GB	15.4" WXGA	Cam	8600M GT	320GB	DVD±RW	* Intel 11n	Blue	Home Prem	Aug 08

- **15.4" widescreen, glossy display**
- **Frameless screen (no plastic frame) to extend to the edges of the PC**
- **Light Weave textured cover**
- **Integrated 1.3 megapixel camera and Lenovo's VeriFace face recognition software helps control access to your notebook by recognizing your face.**
- **Dolby® Home Theater™ premium audio system with four speakers and one subwoofer**
- **Shuttle Center offers a one-stop, total entertainment environment with Shuttle Key that puts volume and equalizer controls on the keyboard**
- **One key system recovery**

Positioning Processor	<i>Widescreen flexibility; two-spindle</i> Intel® Core™ 2 Duo processor T5550 or T5750 with dual-core, Intel 64 Technology, Enhanced Intel SpeedStep™ technology ¹ , Execute Disable Bit, 667MHz system bus, and 2MB L2 cache	Preloaded operating system²⁰ - Microsoft® Windows® Vista® Home Premium Edition (32-bit) ↔ Vista Premium logo
Memory	2GB or 4GB std / 4GB max ⁷ / PC2-5300 667MHz DDR2 , non-parity, dual-channel capable, two 200-pin SO-DIMM sockets; <i>Italics:</i> standard memory in both sockets; no sockets available	Preloaded applications¹⁴ • Lenovo™ OneKey Recovery • Lenovo Anycomm • Norton® AntiVirus 2007 (90 days of virus definitions) • Adobe® Reader • Windows Live™ Toolbar • Easy Capture • Microsoft Office 2007 Trial (60-day) • VeriFace™ Facial Recognition • EarthLink® • Energy Cut • Lenovo Shuttle Center (DVD±RW) • Cyberlink Power2Go (DVD±RW)
Diskette drive EIDE DVD±RW SATA disk	None (use optional USB-based diskette drive) DVD burner, dual-layer support, fixed, not removable, 12.7mm high, tray-in 160GB (5400 rpm), 250GB (5400 rpm), or 320GB (5400 rpm) / SATA 1.5Gb/s, 9.5mm high, removable	Available at these retailers • lenovo.com
Widescreen display Camera	15.4" (391.2mm) WXGA (1280x800) TFT color, VibrantView (glossy), CCFL backlight, 200 nits, 16:10 aspect ratio, 300:1 contrast ratio, frameless screen Camera on top of screen, 1.3-megapixel, fixed focus	
Graphics	NVIDIA® GeForce® 8600M GT , PCI Express® x16, 256MB memory, DirectX® 10, TurboCache, PureVideo™ technology, VGA connector, S-video connector	
Keyboard Multimedia controls Touch pad	Full-size keyboard, 6-row, 84-key, multimedia Fn keys Touch-sensitive audio-video control panel, Shuttle Key Two-button touch pad with scroll feature (no TrackPoint®)	
Dimensions ³ Weight ² Case color Case material Battery - type Battery - life ¹⁰	(<i>WxDxH</i>): 14.2" x 10.3" x 1.2" to 1.4"; 360mm x 262mm x 29 to 36mm with optical drive and battery: <i>6-cell</i> : 6.4 lb (2.91 kg) Black top, black bottom ABS plastic; <i>Palm rest</i> : aluminum Lithium Ion 6-cell , 5200 mAH, smart battery, 5-bar battery indicator Up to 3 hr	
Chipset	Mobile Intel GM965 Express Chipset (Graphics Memory Controller Hub); ICH8M I/O Controller Hub (SATA 3.0Gb/s, ATA-100 EIDE, USB 2.0, PCI Express® 1.1, PCI 2.3), LPC bus	
ExpressCard/54 Multicard reader	One slot (ExpressCard/34, ExpressCard/54) 6-in-1 reader (MultiMedia Card, Memory Stick, Memory Stick PRO™, Secure Digital Card, Secure Digital Elite Pro Card, xD-Picture Card™)	
Ports	Three USB 2.0, external monitor (VGA DB-15), S-video, modem (RJ-11), ethernet (RJ-45), IEEE 1394 FireWire 400 (4-pin connector; 1394a-2000 standard)	
TV tuner Video out Mini PCI Express Intel 11n	None S-video out port (TV-out), one 7-pin industry standard connector Two Mini PCI Express slot 11a/b/g/n wireless, Mini PCIe adapter, Intel Wireless WiFi Link 4965AGN, MIMO 2x3 (Kedron)	
Bluetooth™ Modem Ethernet Audio support	Bluetooth 2.0 wireless, USB 2.0 interface via ICH8M, LED indicator 56K V.92 ⁶ modem 10/100 ethernet, Broadcom® BCM5906M, PCI 2.3 Intel High Definition (HD) Audio, RealTek® ALC882 codec / two main speakers (2 watt), two secondary speaker (1 watt) and subwoofer (2.5 watt), Dolby® Home Theater™ Speaker System / stereo microphone, microphone input jack (3.5 mm), stereo headphone jack (3.5 mm)	
Security Fingerprint reader	Power-on password, hard disk password, supervisor password, security lockhole, VeriFace face recognition software None	Limited Warranty¹² ↔ 1-year parts and labor ↔ Depot repair service¹⁹ ↔ Service upgrade options (in eligible locations):⁹ • 1-year accidental damage protection via depot 43R8885 • 3-year Lenovo Onsite Repair¹³ 9x5 Next Business Day 43R8883 • 3-year Lenovo Onsite Repair¹³ 9x5 Next Business Day with accidental damage protection 43R8884 ↔ 24x7¹⁶ toll-free support for warranty issues during the warranty period¹² via 877-453-6686

See footnotes for important warranty information * Intel Centrino® processor technology
 ⚡ US models announced August 5, 2008; previous models on April 29, 2008



Lenovo IdeaPad Y530



Lenovo IdeaPad Y530



Lenovo IdeaPad Y530



Lenovo IdeaPad Y530



Lenovo IdeaPad Y530



Lenovo IdeaPad Y530

Part number	Processor	GHz	Memory	Widescreen display	Camera	Integrated graphics	SATA disk	SATA optical	Mini PCIe 802.11 wireless	Top color	Blue-tooth	ENERGY STAR 4.0	Vista preload	Avail date
59016229	Pentium T3200	2.00	2GB	15.4" WXGA	Cam	GMA	250GB ⁸	DVD±RW	Intel 5100 ²⁸	Black	None		Prem 32	Nov 08
59016233	Pentium T3200	2.00	3GB	15.4" WXGA	Cam	GMA	160GB	DVD±RW	Intel 5100	Black	None		Prem 32	Oct 08
59016832	Pentium T3200	2.00	3GB	15.4" WXGA	Cam	GMA	160GB	DVD±RW	Intel 5100	Black	None		Prem 32	Nov 08
59016809	Pentium T3200	2.00	3GB	15.4" WXGA	Cam	GMA	160GB	DVD±RW	Intel 5100	Black	None		Prem 32	Nov 08
59015788	Core 2 Duo T5800	2.00	3GB	15.4" WXGA	Cam	GMA	250GB	DVD±RW *	Intel 5100	Black	None	ES40	Prem 32	Nov 08
59015870	Core 2 Duo T5800	2.00	3GB	15.4" WXGA	Cam	GMA	320GB	DVD±RW *	Intel 5100	Black	None	ES40	Prem 32	Oct 08
59015873	Core 2 Duo T5800	2.00	3GB	15.4" WXGA	Cam	GMA	320GB	DVD±RW *	Intel 5100	Black	None	ES40	Prem 32	Nov 08

- 15.4" widescreen, glossy display
- Light Weave textured cover
- Integrated 1.3 megapixel camera and Lenovo's VeriFace face recognition software helps control access to your notebook by recognizing your face.
- Dolby® Home Theater® premium audio system with four speakers and one subwoofer
- HDMI port, HDCP-compliant
- Lenovo Rescue System provides OneKey recovery and OneKey Antivirus without booting into Windows

Positioning Processor	Widescreen flexibility; two-spindle Intel® Pentium® dual-core processor T3200 with dual-core, 667MHz system bus, and 1MB L2 cache or Intel Core™ 2 Duo processor T5800 with dual-core, 800MHz system bus, and 2MB L2 cache	Preloaded operating system ²⁰ - Microsoft® Windows® Vista® Home Premium Edition (32-bit) ◇ Vista Premium logo
Memory	2GB or 3GB std / 4GB max ⁷ / PC2-5300 667MHz DDR2, non-parity, dual-channel capable, two 200-pin SO-DIMM sockets; <i>Italics:</i> standard memory in both sockets; no sockets available	Preloaded applications ¹⁴ • Lenovo™ OneKey Recovery • Lenovo ReadyComm • Norton Internet Security™ (90 days of virus definitions) • Adobe® Reader • Windows Live™ Toolbar • Easy Capture • Microsoft Office 2007 Trial (60-day) • Napster™ To Go® • WildGames™ • Carbonite Online Backup • VeriFace™ Facial Recognition • Lenovo Energy Management Software • Cyberlink Power2Go (DVD±RW)
Diskette drive	None (use optional USB-based diskette drive)	Available at these retailers • B&H™ • J&R™ • Newegg® • TigerDirect • Amazon.com • Supercom (Canada)
SATA DVD±RW	DVD burner, dual-layer support, fixed, not removable, 12.7mm high, tray-in	
SATA disk	160GB (5400 rpm), 250GB (5400 rpm), or 320GB (5400 rpm) / SATA 1.5Gb/s, 9.5mm high, removable	
Widescreen display	15.4" (391.2mm) WXGA (1280x800) TFT color, VibrantView (glossy), CCFL backlight, 200 nits, 16:10 aspect ratio, 400:1 contrast ratio	
Camera	Camera on top of screen, 1.3-megapixel, fixed focus	
Integrated graphics	Intel Graphics Media Accelerator 4500MHD (GMA 4500MHD), in GM45, HDMI port supporting HDCP to output protected content	
Keyboard	Full-size keyboard, 6-row, 84-key, multimedia Fn keys, recovery key	
Multimedia controls	Touch-sensitive audio-video control panel, Shuttle Key	
Touch pad	Two-button touch pad with scroll feature (no TrackPoint®)	
Dimensions ³	(WxDxH): 14.2" x 10.3" x 1.2" to 1.4"; 360mm x 262mm x 29 to 36mm	
Weight ²	with optical drive and battery: 6-cell: 6.6 lb (2.98 kg)	
Case color	Black top, black bottom	
Case material	ABS plastic; Palm rest: aluminum	
Battery - type	Lithium Ion 6-cell, 5200 mAh, smart battery, 5-bar battery indicator	
Battery - life ¹⁰	Up to 3 hr	
Chipset	Mobile Intel GM45 Express Chipset (Memory Controller Hub), ICH9M I/O Controller Hub (SATA 3.0Gb/s, USB 2.0, PCI Express® 1.1, PCI 2.3, ethernet MAC), PCI bus (Ricoh® R5C833 Cardbus/1394/Multicard), LPC bus (IT8752 Super I/O)	65-watt AC adapter Wireless on/off switch Some: ENERGY STAR® 4.0-compliant RoHS-compliant
ExpressCard/54 Multicard reader	One slot (ExpressCard/34, ExpressCard/54) 6-in-1 reader (MultiMedia Card, Memory Stick, Memory Stick PRO™, Secure Digital Card, Secure Digital Elite Pro Card, xD-Picture Card™)	Limited Warranty¹² ⇨ 1-year parts and labor ⇨ Depot repair service ¹⁹ ⇨ Service upgrade options (in eligible locations): ⁹ <ul style="list-style-type: none"> • 1-year accidental damage protection via depot 43R8885 • 3-year Lenovo Onsite Repair¹³ 9x5 Next Business Day 43R8883 • 3-year Lenovo Onsite Repair¹³ 9x5 Next Business Day with accidental damage protection 43R8884 ⇨ 24x7 ¹⁶ toll-free support for warranty issues during the warranty period ¹² via 877-453-6686
Ports	Three USB 2.0, external monitor (VGA DB-15, HDMI), modem (RJ-11), ethernet (RJ-45), IEEE 1394 FireWire 400 (4-pin connector; 1394a-2000 standard)	
TV tuner	None	
Mini PCI Express	Two Mini PCI Express slots	
Intel 5100 ²⁸	11a/b/g/n wireless ⁴ , Mini PCIe adapter, Intel WiFi Link 5100, 1x2 (Shirley Peak)	
Bluetooth™	None	
Modem	56K V.92 ⁶ modem	
Ethernet	10/100 ethernet, Broadcom® BCM5906M, PCI 2.3	
Audio support	High Definition (HD) Audio, RealTek® ALC888S codec / (two main speakers (2 watt), two secondary speakers (1 watt) and subwoofer (2.5 watt), Dolby® Home Theater™ Speaker System / dual array microphone, microphone input jack (3.5 mm), headphone jack (3.5 mm)	
Security	Power-on password, hard disk password, supervisor password, security lockhole, VeriFace face recognition software	
Fingerprint reader	None	

See footnotes for important warranty information * Intel Centrino® processor technology
 Ⓢ US models announced November 12, 2008; previous models on October 22, 2008

Type-model	Processor	GHz	Memory	Widescreen display	CCFL or LED	Camera	Integrated graphics	SATA disk	SATA optical	Mini PCIe 802.11 wireless	Top color	Blue-tooth	ENERGY STAR 4.0	Vista preload	Avail date
4051-2QU	T3200	2.00	2GB	15.4" WXGA	LED	Cam	GMA	160GB ⁸	DVD±RW	Intel 5100 ²⁸	Black			Prem 32	Sep 08
4051-2RU	T3200	2.00	2GB	15.4" WXGA	LED	Cam	GMA	250GB	DVD±RW	Intel 5100	Black			Prem 32	Sep 08
4051-62U	T3200	2.00	2GB	15.4" WXGA	LED	Cam	GMA	320GB	DVD±RW	Intel 5100	Black			Prem 32	Nov 08
4051-2SU	T3200	2.00	3GB	15.4" WXGA	LED	Cam	GMA	250GB	DVD±RW	Intel 5100	Black			Prem 32	Sep 08
4051-63U	T3200	2.00	4GB	15.4" WXGA	LED	Cam	GMA	320GB	DVD±RW	Intel 5100	Black	Blue		Prem 64	Nov 08
4051-2TU	T5800	2.00	2GB	15.4" WXGA	LED	Cam	GMA	250GB	DVD±RW *	Intel 5100	Black	Blue	ES40	Prem 32	Sep 08
4051-42U	T5800	2.00	3GB	15.4" WXGA	LED	Cam	GMA	250GB	DVD±RW *	Intel 5100	Black		ES40	Prem 32	Sep 08
4051-2WU	T5800	2.00	3GB	15.4" WXGA	LED	Cam	GMA	250GB	DVD±RW *	Intel 5100	Black	Blue	ES40	Prem 32	Sep 08
4051-2UU	T5800	2.00	3GB	15.4" WXGA	LED	Cam	GMA	320GB	DVD±RW *	Intel 5100	Black	Blue	ES40	Prem 32	Sep 08
4051-43U	T5800	2.00	4GB	15.4" WXGA	LED	Cam	GMA	320GB	DVD±RW *	Intel 5100	Black		ES40	Prem 64	Sep 08
4051-54U	P7450	2.13	4GB	15.4" WXGA	LED	Cam	GMA	320GB	DVD±RW	Intel 5100	Black		ES40	Prem 64	Jan 09

- 15.4" widescreen, glossy display
- Light Weave textured cover
- Integrated 1.3 megapixel camera and Lenovo's VeriFace face recognition software helps control access to your notebook by recognizing your face.
- Dolby® Home Theater® premium audio system with four speakers and one subwoofer
- HDMI port, HDCP-compliant
- Lenovo Rescue System provides OneKey recovery and OneKey Antivirus without booting into Windows

Positioning Processor	Widescreen flexibility; two-spindle Intel® Pentium® dual-core processor T3200 with dual-core, 667MHz system bus, and 1MB L2 cache or Intel Core™ 2 Duo processor T5800 or P7450 with dual-core, 800MHz system bus; T5800: 2MB L2 cache; P7450: 3MB L2 cache	Preloaded operating system ²⁰ - Some: Microsoft® Windows® Vista® Home Premium Edition (32-bit) - Some: Microsoft Windows Vista Home Premium Edition (64-bit) ◇ Vista Premium logo
Memory	2GB, 3GB, or 4GB std / 4GB max ³¹ ; Italics: standard memory in both sockets; no sockets available; 42U/43U: PC2-5300 667MHz DDR2, non-parity, dual-channel capable, two 200-pin SO-DIMM sockets; Others: PC3-8500 1066MHz DDR3, non-parity, dual-channel capable, two 204-pin SO-DIMM sockets	Preloaded applications ¹⁴ (only some listed) • Lenovo® OneKey Recovery • Lenovo ReadyComm • Norton Internet Security™ (90 days of virus definitions) • Easy Capture • Microsoft Office 2007 Trial (60-day) • Carbonite Online Backup • VeriFace™ Facial Recognition • Lenovo Energy Management Software • Cyberlink Power2Go (DVD±RW)
Diskette drive SATA DVD±RW SATA disk	None (use optional USB-based diskette drive) DVD burner, dual-layer support, fixed, not removable, 12.7mm high, tray-in 160GB (5400 rpm), 250GB (5400 rpm), or 320GB (5400 rpm) / SATA 1.5Gb/s, 9.5mm high, removable	
Widescreen display	15.4" (391.2mm) WXGA (1280x800) TFT color, VibrantView (glossy), Some: CCFL backlight, 200 nits, 16:10 aspect ratio, 400:1 contrast ratio Some: LED backlight, 200 nits, 16:10 aspect ratio, 400:1 contrast ratio	
Camera	Camera on top of screen, 1.3-megapixel, fixed focus	
Integrated graphics	Intel Graphics Media Accelerator 4500MHD (GMA 4500MHD), in GM45, HDMI port supporting HDCP to output protected content	
Keyboard Multimedia controls Touch pad	Full-size keyboard, 6-row, 84-key, multimedia Fn keys, recovery key Touch-sensitive audio-video control panel, Shuttle Key Two-button touch pad with scroll feature (no TrackPoint®)	
Dimensions ³ Weight ² Case color Case material Battery - type Battery - life ¹⁰	(WxDxH): 14.2" x 10.3" x 1.2" to 1.4"; 360mm x 262mm x 29 to 36mm with optical drive and battery: 6-cell: 6.6 lb (2.98 kg) Black top, black bottom ABS plastic; Palm rest: aluminum Lithium Ion 6-cell, 5200 mAh, smart battery, 5-bar battery indicator Up to 3 hr	Available at these retailers • lenovo.com • Fry's • Circuit City®
Chipset	Mobile Intel GM45 Express Chipset (Memory Controller Hub), ICH9M I/O Controller Hub (SATA 3.0Gb/s, USB 2.0, PCI Express® 1.1, PCI 2.3, ethernet MAC), PCI bus (Ricoh® R5C833 Cardbus/1394/Multicard), LPC bus (IT8752 Super I/O)	65-watt AC adapter Wireless on/off switch Some: ENERGY STAR® 4.0-compliant RoHS-compliant
ExpressCard/54 Multicard reader	One slot (ExpressCard/34, ExpressCard/54) 6-in-1 reader (MultiMedia Card, Memory Stick, Memory Stick PRO™, Secure Digital Card, Secure Digital Elite Pro Card, xD-Picture Card™)	Limited Warranty ¹² ↪ 1-year parts and labor ↪ Depot repair service ¹⁹ ↪ Service upgrade options (in eligible locations): ⁹ • 1-year accidental damage protection via depot 43R8885 • 3-year Lenovo Onsite Repair ¹³ 9x5 Next Business Day 43R8883 • 3-year Lenovo Onsite Repair ¹³ 9x5 Next Business Day with accidental damage protection 43R8884 ↪ 24x7 ¹⁶ toll-free support for warranty issues during the warranty period ¹² via 877-453-6686
Ports	Three USB 2.0, external monitor (VGA DB-15, HDMI), modem (RJ-11), ethernet (RJ-45), IEEE 1394 FireWire 400 (4-pin connector; 1394a-2000 standard)	
TV tuner Mini PCI Express Intel 5100 ²⁸ Bluetooth™ Modem Ethernet Audio support	None Two Mini PCI Express slots 11a/b/g/n wireless ⁴ , Mini PCIe adapter, Intel WiFi Link 5100, 1x2 (Shirley Peak) Some: Bluetooth 2.1 wireless, USB 2.0 interface via ICH9M, LED indicator 56K ⁶ V.92 ¹⁵ modem 10/100 ethernet, Broadcom® BCM5906M, PCI 2.3 High Definition (HD) Audio, RealTek® ALC888S codec / two main speakers (2 watt), two secondary speakers (1 watt) and subwoofer (2.5 watt), Dolby® Home Theater™ Speaker System / dual array microphone, microphone input jack (3.5 mm), headphone jack (3.5 mm)	
Security	Power-on password, hard disk password, supervisor password, security lockhole, VeriFace face recognition software	
Fingerprint reader	None	

See footnotes for important warranty information

* Intel Centrino® processor technology

Ⓜ US model announced January 13, 2009; previous models on September 9, September 16, or November 18, 2008

Ⓜ Intel Centrino 2 processor technology

© Lenovo (MKL2-2) January 2009

Type-model	Processor	GHz	Memory	Widescreen display	CCFL or LED	Camera	Discrete graphics	SATA disk	SATA optical	Mini PCIe 802.11 wireless	Top color	Blue-tooth	Vista preload	Avail date
4051-2XU	T5800	2.00	2GB	15.4" WXGA	LED	Cam	9300M GS	250GB ⁸	DVD±RW	* Intel 5100 ²⁸	Black	Blue	Prem 32	Sep 08
4051-64U	T5800	2.00	4GB	15.4" WXGA	LED	Cam	9300M GS	320GB	DVD±RW	* Intel 5100	Black	Blue	Prem 64	Nov 08
4051-2AU	P7350	2.00	2GB	15.4" WXGA		Cam	9300M GS	250GB	DVD±RW	⚡ Intel 5100	Black	Blue	Prem 32	Aug 08
4051-2NU	P7350	2.00	2GB	15.4" WXGA	LED	Cam	9300M GS	250GB	DVD±RW	⚡ Intel 5100	Black	Blue	Prem 32	Sep 08
4051-2BU	P7350	2.00	3GB	15.4" WXGA		Cam	9300M GS	320GB	DVD±RW	⚡ Intel 5100	Black	Blue	Prem 32	Aug 08
4051-2PU	P7350	2.00	3GB	15.4" WXGA	LED	Cam	9300M GS	320GB	DVD±RW	⚡ Intel 5100	Black	Blue	Prem 32	Sep 08
4051-2YU	P8400	2.26	4GB	15.4" WXGA	LED	Cam	9500M G	320GB	DVD±RW	⚡ Intel 5100	Black	Blue	Prem 64	Sep 08

- 15.4" widescreen, glossy display
- Frameless screen (no plastic frame) to extend to the edges of the PC
- Light Weave textured cover
- Integrated 1.3 megapixel camera and Lenovo's VeriFace face recognition software helps control access to your notebook by recognizing your face.
- Dolby® Home Theater® premium audio system with four speakers and one subwoofer
- HDMI port, HDCP-compliant
- Lenovo Rescue System provides OneKey recovery and OneKey Antivirus without booting into Windows

Positioning Processor	Widescreen flexibility; two-spindle Intel® Core™ 2 Duo processor T5800 with dual-core, 800MHz system bus, and 2MB L2 cache or Intel Core 2 Duo processor P7350 or P8400 with dual-core, Intel HD Boost, 1066MHz system bus, and 3MB L2 cache	Preloaded operating system ²⁰ - Some: Microsoft® Windows® Vista® Home Premium Edition (32-bit) - Some: Microsoft Windows Vista Home Premium Edition (64-bit) ⚡ Vista Premium logo Preloaded applications ¹⁴ (only some listed) • Lenovo™ OneKey Recovery • Lenovo ReadyComm • Norton Internet Security™ (90 days of virus definitions) • Adobe® Reader • Windows Live™ Toolbar • Easy Capture • Microsoft Office 2007 Trial (60-day) • WildGames™ • Carbonite Online Backup • VeriFace™ Facial Recognition • Lenovo Energy Management Software • Cyberlink Power2Go (DVD±RW)
Memory	2GB, 3GB, or 4GB std / 4GB max ⁷ ; Italics: standard memory in both sockets; no sockets available; 2AU/2BU: PC2-5300 667MHz DDR2, non-parity, dual-channel capable, two 200-pin SO-DIMM sockets; Others: PC3-8500 1066MHz DDR3, non-parity, dual-channel capable, two 204-pin SO-DIMM sockets	
Diskette drive SATA DVD±RW SATA disk	None (use optional USB-based diskette drive) DVD burner, dual-layer support, fixed, not removable, 12.7mm high, tray-in 250GB (5400 rpm) or 320GB (5400 rpm) / SATA 1.5Gb/s, 9.5mm high, removable	
Widescreen display	15.4" (391.2mm) WXGA (1280x800) TFT color, VibrantView (glossy); Some: CCFL backlight, 200 nits, 16:10 aspect ratio, 400:1 contrast ratio, frameless screen Some: LED backlight, 200 nits, 16:10 aspect ratio, 400:1 contrast ratio, frameless screen	
Camera	Camera on top of screen, 1.3-megapixel, fixed focus	
Discrete graphics	Some: NVIDIA® GeForce® 9300M GS, PCI Express® x16, 256MB memory, DirectX® 10, PureVideo® HD technology, VGA, HDMI, HDCP-compliant Some: NVIDIA GeForce 9500M G, PCI Express x16, 512MB memory, DirectX 10, PureVideo HD technology, VGA, HDMI, HDCP-compliant	
Keyboard Multimedia controls Touch pad	Full-size keyboard, 6-row, 84-key, multimedia Fn keys, recovery key Touch-sensitive audio-video control panel, Shuttle Key Two-button touch pad with scroll feature (no TrackPoint®)	
Dimensions ³ Weight ² Case color Case material Battery - type Battery - life ¹⁰	(WxDxH): 14.2" x 10.3" x 1.2" to 1.4"; 360mm x 262mm x 29 to 36mm with optical drive and battery: 6-cell: 6.6 lb (2.98 kg) Black top, black bottom ABS plastic; Palm rest: aluminum Lithium Ion 6-cell, 5200 mAH, smart battery, 5-bar battery indicator Up to 3 hr	Available at these retailers • lenovo.com
Chipset	Mobile Intel GM45 Express Chipset (Memory Controller Hub), ICH9M I/O Controller Hub (SATA 3.0Gb/s, USB 2.0, PCI Express® 1.1, PCI 2.3, ethernet MAC), PCI bus (Ricoh® R5C833 Cardbus/1394/Multicard), LPC bus (IT8752 Super I/O)	90-watt AC adapter Wireless on/off switch ENERGY STAR® 4.0-compliant RoHS-compliant
ExpressCard/54 Multicard reader	One slot (ExpressCard/34, ExpressCard/54) 6-in-1 reader (MultiMedia Card, Memory Stick, Memory Stick PRO™, Secure Digital Card, Secure Digital Elite Pro Card, xD-Picture Card™)	Limited Warranty ¹² ↔ 1-year parts and labor ↔ Depot repair service ¹⁹ ↔ Service upgrade options (in eligible locations): ⁹ • 1-year accidental damage protection via depot 43R8885 • 3-year Lenovo Onsite Repair ¹³ 9x5 Next Business Day 43R8883 • 3-year Lenovo Onsite Repair ¹³ 9x5 Next Business Day with accidental damage protection 43R8884 ↔ 24x7 ¹⁶ toll-free support for warranty issues during the warranty period ¹² via 877-453-6686
Ports	Three USB 2.0, external monitor (VGA DB-15, HDMI), modem (RJ-11), ethernet (RJ-45), IEEE 1394 FireWire 400 (4-pin connector; 1394a-2000 standard)	
TV tuner Mini PCI Express Intel 5100 ²⁸ Bluetooth™ Modem Ethernet Audio support	None Two Mini PCI Express slots 11a/b/g/n wireless ⁴ , Mini PCIe adapter, Intel WiFi Link 5100, 1x2 (Shirley Peak) Bluetooth 2.1 wireless, USB 2.0 interface via ICH9M, LED indicator 56K V.92 ⁶ modem 10/100 ethernet, Broadcom® BCM5906M, PCI 2.3 Intel High Definition (HD) Audio, RealTek® ALC888S codec / two main speakers (2 watt), two secondary speakers (1 watt) and subwoofer (2.5 watt), Dolby® Home Theater™ Speaker System / dual array microphone, microphone input jack (3.5 mm), headphone jack (3.5 mm)	
Security	Power-on password, hard disk password, supervisor password, security lockhole, VeriFace face recognition software	
Fingerprint reader	None	

See footnotes for important warranty information
⁸ US model announced November 18, 2008; previous models on August 19 or September 16, 2008

* Intel Centrino® processor technology
 ⚡ Intel Centrino 2 processor technology



Lenovo IdeaPad Y710



Lenovo IdeaPad Y710



Lenovo IdeaPad Y710



Lenovo IdeaPad Y710
(Game Zone on select models)



Lenovo IdeaPad Y710
(Game Zone on select models)



Lenovo IdeaPad Y710

Part number	Processor	GHz	Memory	Widescreen display	Camera	Graphics controller	SATA disk(s)	EIDE optical	Mini PCIe 802.11 wireless	Bluetooth	Vista preload	Avail date
59012817	T5450	1.66	2GB	17.0" WXGA+	Camera	HD 2600	1 x 250GB ⁸	DVD±RW	*Intel 11n ²⁸	Blue	Home Prem	Jan 08
59013787	T5550	1.83	3GB	17.0" WXGA+	Camera	HD 2600	1 x 250GB	DVD±RW	*Intel 11n	Blue	Home Prem	Apr 08
59012816	T9300	2.50	2GB	17.0" WXGA+	Camera	HD 2600	2 x 250GB	Blu-ray	*Intel 11n	Blue	Home Prem	Feb 08
59013334	T9300	2.50	2GB	17.0" WXGA+	Camera	HD 2600	2 x 250GB	Blu-ray	*Intel 11n	Blue	Home Prem	Mar 08

- 17.0" widescreen, glossy display
- Frameless screen (no plastic frame) to extend to the edges of the PC
- Blue metallic finish
- Halo Lighting to emit a different color light from side bezel and Lenovo logo on cover
- Integrated 1.3 megapixel camera and Lenovo's VeriFace face recognition software helps control access to your notebook by recognizing your face.
- Dolby® Home Theater™ premium audio system with four speakers and one subwoofer
- Shuttle Center offers a one-stop, total entertainment environment with Shuttle Key that puts volume and equalizer controls on the keyboard
- HDMI port, HDCP-compliant
- One key system recovery
- Hot-swap secondary disk capability on select models



Positioning Processor	Widescreen flexibility Intel® Core™ 2 Duo processor T5450 or T5550 with dual-core, Intel 64 Technology, Enhanced Intel SpeedStep® technology ¹ , Execute Disable Bit, 667MHz system bus, and 2MB L2 cache or Intel Core 2 Duo processor T9300 with dual-core, Intel 64 Technology, Enhanced Intel SpeedStep® technology, Intel Dynamic Acceleration, Execute Disable Bit, Virtualization Technology, 800MHz bus, and 6MB L2 cache	Preloaded operating system ²⁰ - Microsoft® Windows® Vista® Home Premium Edition (32-bit) ♦ Vista Premium logo Preloaded applications ¹⁴ • Lenovo™ OneKey Recovery • Norton® AntiVirus 2007 (90 days of virus definitions) • Adobe® Reader • Windows Live™ Toolbar • Easy Capture • Microsoft Office 2007 Trial (60-day) • VeriFace™ Facial Recognition • EarthLink® • Energy Cut • Lenovo Shuttle Center (DVD±RW, Blu-ray) • Cyberlink Power2Go (DVD±RW, Blu-ray)	
Memory	2GB or 3GB std / 4GB max ⁷ / PC2-5300 667MHz DDR2 , non-parity, dual-channel capable, two 200-pin SO-DIMM sockets; <i>Italics:</i> standard memory in both sockets; no sockets available		
Diskette drive	None (use optional USB-based diskette drive)		
EIDE DVD±RW	<i>Some:</i> DVD burner, dual-layer support, fixed, not removable, 12.7mm, tray-in		
EIDE Blu-ray™	<i>Some:</i> Blu-ray Disc reader (no Blu-ray media burning), BD-ROM, no HD-DVD playback, DVD and CD recordable, not removable, 12.7mm high, tray-in		
SATA disk	250GB (5400 rpm) / SATA 1.5Gb/s, 9.5mm high, removable and upgradable		
Secondary disk	<i>Some:</i> 250GB (5400 rpm) / SATA 1.5Gb/s, 9.5mm high, removable and upgradable, hot-swap support, external support via USB cable		
Widescreen display	17.0" (431.8mm) WXGA+ (1440x900) TFT color, VibrantView (glossy), CCFL backlight, 200 nits, 16:10 aspect ratio, 500:1 contrast ratio, frameless screen		
Camera	Camera on top of screen, 1.3-megapixel, fixed focus		
Graphics	ATI™ Mobility Radeon™ HD 2600 , PCI Express® x16, 256MB memory, DirectX® 10, ATI Avivo™, VGA connector (with VGA-in support), HDMI connector, HDCP-compliant		
Keyboard	Full-size keyboard, 6-row, 84-key, multimedia Fn keys, numeric keypad on right		
Multimedia controls	Touch-sensitive audio-video control panel, Shuttle Key		
Touch pad	Two-button touch pad with scroll feature (no TrackPoint®)		
Dimensions ³	(WxDxH): 15.5" x 11.2" x 1.02" to 1.53"; 395mm x 285mm x 26 to 39mm	Available at these retailers • B&H™ • J&R™ • RCSEXPERIENCE • TigerDirect	
Weight ²	with optical drive and battery: 7.9 lb (3.6 kg)		
Case color	Blue top, black bottom		
Case material	ABS plastic		
Battery - type	Lithium Ion 6-cell , 5200 mAh, smart battery, 5-bar battery indicator		
Battery - life ¹⁰	Up to 3.5 hr		
Chipset	Mobile Intel GM965 Express Chipset (Graphics Memory Controller Hub); ICH8M I/O Controller Hub (SATA 3.0Gb/s, ATA-100 EIDE, USB 2.0, PCI Express 1.1, PCI 2.3), LPC bus		135-watt AC adapter Wireless on/off switch VGA in/out switch ENERGY STAR® 4.0-compliant RoHS-compliant
ExpressCard/54	One slot (ExpressCard/34, ExpressCard/54)		
Multicard reader	6-in-1 reader (MultiMedia Card, Memory Stick, Memory Stick PRO™, Secure Digital Card, Secure Digital Elite Pro Card, xD-Picture Card™)		Limited Warranty ¹² ⇨ 1-year parts and labor ⇨ Depot repair service ¹⁹ ⇨ Service upgrade options (in eligible locations): ⁹ • 1-year accidental damage protection via depot 43R8885 • 3-year Lenovo Onsite Repair ¹³ 43R8883 • 3-year Lenovo Onsite Repair ¹³ 43R8883 • 9x5 Next Business Day with accidental damage protection 43R8884 ⇨ 24x7¹⁶ toll-free support for warranty issues during the warranty period ¹² via 877-453-6686
Ports	Four USB 2.0, external monitor (VGA DB-15, HDMI), S-video, modem (RJ-11), ethernet (RJ-45), IEEE 1394 FireWire 400 (4-pin connector; 1394a-2000 standard)		
TV tuner	None		
Mini PCI Express	One Mini PCI Express slot		
Intel 11n ²⁸	11a/b/g/n wireless ⁴ , Mini PCIe adapter, Intel Wireless WiFi Link 4965AGN, MIMO 2x3 (Kedron)		
Bluetooth™	Bluetooth 2.0 wireless, USB 2.0 interface via ICH8M, LED indicator		
Modem	56K V.92 ⁶ modem		
Ethernet	10/100 ethernet, Broadcom® BCM5906M, PCI 2.3		
Audio support	Intel High Definition (HD) Audio, RealTek® ALC888S codec / two main speakers (2 watt), two secondary speakers(1.5 watt) and subwoofer (3 watt), Dolby Home Theater Speaker System / stereo microphone, microphone input jack (3.5 mm), stereo headphone jack (3.5 mm)		
Security	Power-on password, hard disk password, supervisor password, security keyhole, VeriFace facial recognition software		
Fingerprint reader	None		

See footnotes for important warranty information

* Intel Centrino® processor technology

† US model announced April 15, 2008; previous models on January 6, January 29, or March 25, 2008

Part number	Processor	GHz	Memory	Widescreen display	Camera	Graphics controller	SATA disk(s)	EIDE optical	Mini PCIe 802.11 wireless	Bluetooth	Game Zone	Vista preload	Avail date
59013729	T8100	2.10	4GB	17.0" WUXGA	Camera	HD 2600	1 x 250GB ⁸	DVD±RW	*Intel 11n ²⁸	Blue	Game	Home Prem	May 08
59013620	X9000	2.80	4GB	17.0" WUXGA	Camera	HD 2600	2 x 250GB	Blu-ray	*Intel 11n	Blue	Game	Home Prem	Jun 08
59013785	X9000	2.80	4GB	17.0" WUXGA	Camera	HD 2600	2 x 250GB	Blu-ray	*Intel 11n	Blue	Game	Home Prem	Jun 08

- 17.0" widescreen, glossy display
- Frameless screen (no plastic frame) to extend to the edges of the PC
- Blue metallic finish
- Halo Lighting to emit a different color light from side bezel and Lenovo logo on cover
- Game Zone with secondary display, user-defined keys, performance control switch and enlarged direction keys
- Integrated 1.3 megapixel camera and Lenovo's VeriFace face recognition software helps control access to your notebook by recognizing your face.
- Dolby® Home Theater™ premium audio system with four speakers and one subwoofer
- Shuttle Center offers a one-stop, total entertainment environment with Shuttle Key that puts volume and equalizer controls on the keyboard
- HDMI port, HDCP-compliant
- One key system recovery



Positioning Processor	Widescreen flexibility Intel® Core™ 2 Duo processor T8100 with dual-core, Intel 64 Technology, Enhanced Intel SpeedStep® technology, Intel Dynamic Acceleration, Execute Disable Bit, Virtualization Technology, 800MHz bus, and 3MB L2 cache or Intel Core 2 Extreme processor X9000 with dual-core, Intel 64 Technology, Enhanced Intel SpeedStep® technology, Execute Disable Bit, Virtualization Technology, 800MHz bus, and 6MB L2 cache	Preloaded operating system ²⁰ - Microsoft® Windows® Vista® Home Premium Edition (32-bit) ◇ Vista Premium logo Preloaded applications ¹⁴ • Lenovo™ OneKey Recovery • Norton® AntiVirus 2007 (90 days of virus definitions) • Adobe® Reader • Windows Live™ Toolbar • Easy Capture • Microsoft Office 2007 Trial (60-day) • VeriFace™ Facial Recognition • EarthLink® • Energy Cut • Lenovo Shuttle Center (DVD±RW, Blu-ray) • Cyberlink Power2Go (DVD±RW, Blu-ray)
Memory	4GB std / 4GB max ⁷ / PC2-5300 667MHz DDR2 , non-parity, dual-channel capable, two 200-pin SO-DIMM sockets; <i>Italics:</i> standard memory in both sockets; no sockets available	
Diskette drive EIDE DVD±RW EIDE Blu-ray™	None (use optional USB-based diskette drive) <i>Some:</i> DVD burner, dual-layer support, fixed, not removable, 12.7mm, tray-in <i>Some:</i> Blu-ray Disc reader (no Blu-ray media burning), BD-ROM, no HD-DVD playback, DVD and CD recordable, not removable, 12.7mm high, tray-in	
SATA disk Secondary disk	250GB (5400 rpm) / SATA 1.5Gb/s, 9.5mm high, removable and upgradable <i>Some:</i> 250GB (5400 rpm) / SATA 1.5Gb/s, 9.5mm high, removable and upgradable, hot-swap support, external support via USB cable	
Widescreen display Camera	17.0" (431.8mm) WUXGA (1920x1200) TFT color, VibrantView (glossy), CCFL backlight, 300 nits, 16:10 aspect ratio, 500:1 contrast ratio, frameless screen Camera on top of screen, 1.3-megapixel, fixed focus	
Graphics	ATI™ Mobility Radeon™ HD 2600 , PCI Express® x16, 512MB memory, DirectX® 10, ATI Avivo™, VGA connector (with VGA-in support), HDMI connector, HDCP-compliant	
Keyboard Game Zone Multimedia controls Touch pad	Full-size keyboard, 6-row, 84-key, multimedia Fn keys Secondary display, user-defined keys, performance switch, enlarged direction keys Touch-sensitive audio-video control panel, Shuttle Key Two-button touch pad with scroll feature (no TrackPoint®)	
Dimensions ³ Weight ² Case color Case material Battery - type Battery - life ¹⁰	(<i>WxDxH</i>): 15.5" x 11.2" x 1.02" to 1.53"; 395mm x 285mm x 26 to 39mm with optical drive and battery: 7.9 lb (3.6 kg) Blue top, black bottom ABS plastic Lithium Ion 6-cell , 5200 mAh, smart battery, 5-bar battery indicator Up to 3.5 hr	Available at these retailers • B&H™ • J&R™ • Newegg® • RCSEXPERIENCE • TigerDirect
Chipset	Mobile Intel GM965 Express Chipset (Graphics Memory Controller Hub); ICH8M I/O Controller Hub (SATA 3.0Gb/s, ATA-100 EIDE, USB 2.0, PCI Express 1.1, PCI 2.3), LPC bus	135-watt AC adapter Wireless on/off switch VGA in/out switch ENERGY STAR® 4.0-compliant RoHS-compliant
ExpressCard/54 Multicard reader	One slot (ExpressCard/34, ExpressCard/54) 6-in-1 reader (MultiMedia Card, Memory Stick PRO™, Secure Digital Card, Secure Digital Elite Pro Card, xD-Picture Card™)	
Ports	Four USB 2.0, external monitor (VGA DB-15, HDMI), S-video, modem (RJ-11), ethernet (RJ-45), IEEE 1394 FireWire 400 (4-pin connector; 1394a-2000 standard)	Limited Warranty ¹² ⇒ 1-year parts and labor ⇒ Depot repair service ¹⁹ ⇒ Service upgrade options (in eligible locations): ⁹ • 1-year accidental damage protection via depot 43R8885 • 3-year Lenovo Onsite Repair ¹³ 9x5 Next Business Day 43R8883 • 3-year Lenovo Onsite Repair ¹³ 9x5 Next Business Day with accidental damage protection 43R8884 ⇒ 24x7¹⁶ toll-free support for warranty issues during the warranty period ¹² via 877-453-6686
TV tuner Mini PCI Express Intel 11n ²⁸	None One Mini PCI Express slot 11a/b/g/n wireless ⁴ , Mini PCIe adapter, Intel Wireless WiFi Link 4965AGN, MIMO 2x3 (Kedron)	
Bluetooth™ Modem Ethernet Audio support	Bluetooth 2.0 wireless, USB 2.0 interface via ICH8M, LED indicator 56K V.92 ⁶ modem 10/100 ethernet, Broadcom® BCM5906M, PCI 2.3 Intel High Definition (HD) Audio, RealTek® ALC888S codec / two main speakers (2 watt), two secondary speakers(1.5 watt) and subwoofer (3 watt), Dolby Home Theater Speaker System / stereo microphone, microphone input jack (3.5 mm), stereo headphone jack (3.5 mm)	
Security	Power-on password, hard disk password, supervisor password, security keyhole, VeriFace facial recognition software	
Fingerprint reader	None	

See footnotes for important warranty information * Intel Centrino® processor technology
²⁸ US models announced June 27, 2008; previous model on May 12, 2008

Part number	Processor	GHz	Memory	Widescreen display	Camera	Graphics controller	SATA disk(s)	EIDE optical	Mini PCIe 802.11 wireless	Bluetooth	Keypad / Game Zone	Vista preload	Avail date
59014906	T2390	1.86	2GB	17.0" WXGA+	Camera	HD 2600 512M	1 x 160GB ⁸	DVD±RW	Intel 11n ²⁸	Blue	Keypad	Home Prem	Jul 08
59014832	T2390	1.86	2GB	17.0" WXGA+	Camera	HD 2600 512M	1 x 250GB	DVD±RW	Intel 11n	Blue	Keypad	Home Prem	Aug 08
59014756	T2390	1.86	3GB	17.0" WXGA+	Camera	HD 2600 512M	1 x 250GB	DVD±RW	Intel 11n	Blue	Keypad	Home Prem	Jul 08
59014927	T5750	2.00	2GB	17.0" WXGA+	Camera	HD 2600 512M	1 x 250GB	DVD±RW	* Intel 11n	Blue	Keypad	Home Prem	Jul 08
59013620	X9000	2.80	4GB	17.0" WUXGA	Camera	HD 2600 512M	2 x 250GB	Blu-ray	* Intel 11n	Blue	Game	Home Prem	Jul 08

• 17.0" widescreen, glossy display
• Frameless screen (no plastic frame) to extend to the edges of the PC
• Blue metallic finish
• Game Zone with secondary display, user-defined keys, performance control switch and enlarged direction keys on select models
• Integrated 1.3 megapixel camera and Lenovo's VeriFace face recognition software helps control access to your notebook by recognizing your face.
• Dolby® Home Theater™ premium audio system with four speakers and one subwoofer
• HDMI port, HDCP-compliant
• Hot-swap secondary disk capability on select models



Positioning	<i>Widescreen flexibility</i>	Preloaded operating system²⁰ - Microsoft® Windows® Vista® Home Premium Edition (32-bit) ⇨ Vista Premium logo Preloaded applications¹⁴ • Lenovo™ OneKey Recovery • Norton® AntiVirus 2007 (90 days of virus definitions) • Adobe® Reader • Windows Live™ Toolbar • Easy Capture • Microsoft Office 2007 Trial (60-day) • VeriFace™ Facial Recognition • EarthLink® • Energy Cut • Lenovo Shuttle Center (DVD±RW, Blu-ray) • Cyberlink Power2Go (DVD±RW, Blu-ray)
Processor	Intel® Pentium® Dual-Core Processor T2390 with dual-core, Intel 64 Technology, 533MHz system bus, and 1MB L2 cache or Intel Core™ 2 Duo processor T5750 with dual-core, Intel 64 Technology, 667MHz system bus, and 2MB L2 cache or Intel Core 2 Extreme processor X9000 with dual-core, Intel 64 Technology, 800MHz bus, and 6MB L2 cache	
Memory	2GB, 3GB, or 4GB std / 4GB max ⁷ / PC2-5300 667MHz DDR2, non-parity, dual-channel capable, two 200-pin SO-DIMM sockets; <i>Italics:</i> standard memory in both sockets; no sockets available	
Diskette drive	None (use optional USB-based diskette drive)	
EIDE DVD±RW	<i>Some:</i> DVD burner, dual-layer support, fixed, not removable, 12.7mm, tray-in	
EIDE Blu-ray™	<i>Some:</i> Blu-ray Disc reader (no Blu-ray media burning), BD-ROM, no HD-DVD playback, DVD and CD recordable, not removable, 12.7mm high, tray-in	
SATA disk	160 (5400 rpm) or 250GB (5400 rpm) / SATA 1.5Gb/s, 9.5mm high, removable and upgradable	
Secondary disk	<i>Some:</i> 250GB (5400 rpm) / SATA 1.5Gb/s, 9.5mm high, removable and upgradable, hot-swap support, external support via USB cable	
Widescreen display	<i>Some:</i> 17.0" (431.8mm) WXGA+ (1440x900) TFT color, 200 nits <i>Some:</i> 17.0" (431.8mm) WUXGA (1920x1200) TFT color, 300 nits <i>All:</i> VibrantView (glossy), CCFL backlight, 16:10 aspect ratio, 500:1 contrast ratio, frameless screen	
Camera	Camera on top of screen, 1.3-megapixel, fixed focus	
Graphics	ATI™ Mobility Radeon™ HD 2600, PCI Express® x16, 512MB memory, DirectX® 10, ATI Avivo™, VGA connector (with VGA-in support), HDMI connector, HDCP-compliant	
Keyboard	Full-size keyboard, 6-row, 84-key, multimedia Fn keys	
Numeric keypad	<i>Some:</i> Numeric keypad on right of keyboard	
Game Zone	<i>Some:</i> Secondary display, user-defined keys, performance switch, enlarged direction keys	
Multimedia controls	Touch-sensitive audio-video control panel, Shuttle Key	
Touch pad	Two-button touch pad with scroll feature (no TrackPoint®)	
Dimensions ³	(WxDxH): 15.5" x 11.2" x 1.02" to 1.53"; 395mm x 285mm x 26 to 39mm	
Weight ²	with optical drive and battery: 7.9 lb (3.6 kg)	
Case color	Blue top, black bottom	
Case material	ABS plastic	
Battery - type	Lithium Ion 6-cell, 5200 mAh, smart battery, 5-bar battery indicator	
Battery - life ¹⁰	Up to 3.5 hr	
Chipset	Mobile Intel GM965 Express Chipset (Graphics Memory Controller Hub); ICH8M I/O Controller Hub (SATA 3.0Gb/s, ATA-100 EIDE, USB 2.0, PCI Express 1.1, PCI 2.3), LPC bus	
ExpressCard/54	One slot (ExpressCard/34, ExpressCard/54)	
Multicard reader	6-in-1 reader (MultiMedia Card, Memory Stick, Memory Stick PRO™, Secure Digital Card, Secure Digital Elite Pro Card, xD-Picture Card™)	
Ports	Four USB 2.0, external monitor (VGA DB-15, HDMI), S-video, modem (RJ-11), ethernet (RJ-45), IEEE 1394 FireWire 400 (4-pin connector; 1394a-2000 standard)	
TV tuner	None	
Mini PCI Express	One Mini PCI Express slot	
Intel 11n ²⁸	11a/b/g/n wireless ⁴ , Mini PCIe adapter, Intel Wireless WiFi Link 4965AGN, MIMO 2x3 (Kedron)	
Bluetooth™	Bluetooth 2.0 wireless, USB 2.0 interface via ICH8M, LED indicator	
Modem	56K V.92 ⁶ modem	
Ethernet	10/100 ethernet, Broadcom® BCM5906M, PCI 2.3	
Audio support	Intel High Definition (HD) Audio, RealTek® ALC888S codec / two main speakers (2 watt), two secondary speakers(1.5 watt) and subwoofer (3 watt), Dolby Home Theater Speaker System / stereo microphone, microphone input jack (3.5 mm), stereo headphone jack (3.5 mm)	
Security	Power-on password, hard disk password, supervisor password, security keyhole, VeriFace facial recognition software	
Fingerprint reader	None	

Available at these retailers

- B&H™
- Newegg®
- TigerDirect
- The Source (Canada)

135-watt AC adapter
Wireless on/off switch
VGA in/out switch
ENERGY STAR® 4.0-compliant
RoHS-compliant

Limited Warranty¹²

- ⇨ 1-year parts and labor
- ⇨ Depot repair service¹⁹
- ⇨ Service upgrade options (in eligible locations):⁹
 - 1-year accidental damage protection via depot 43R8885
 - 3-year Lenovo Onsite Repair¹³ 9x5 Next Business Day 43R8883
 - 3-year Lenovo Onsite Repair¹³ 9x5 Next Business Day with accidental damage protection 43R8884
- ⇨ 24x7¹⁶ toll-free support for warranty issues during the warranty period¹² via 877-453-6686

See footnotes for important warranty information
US models announced July 15, 2008

* Intel Centrino® processor technology

Type-model	Processor	GHz	Memory	Widescreen display	Camera	Graphics controller	SATA disk(s)	EIDE optical	Mini PCIe 802.11 wireless	Bluetooth	Keypad / Game Zone	Vista preload	Avail date
4054-2CU	T5550	1.83	2GB	17.0" WXGA+	Camera	HD 2600 256M	1 x 250GB ⁸	DVD±RW	*Intel 11n ²⁸	Blue	Keypad	Home Prem	May 08
4054-2DU	T5750	2.00	2GB	17.0" WXGA+	Camera	HD 2600 256M	1 x 250GB	DVD±RW	*Intel 11n	Blue	Keypad	Home Prem	Aug 08
4054-2AU	T8100	2.10	4GB	17.0" WUXGA	Camera	HD 2600 512M	1 x 250GB	DVD±RW	*Intel 11n	Blue	Game	Home Prem	May 08
4054-2BU	X9000	2.80	4GB	17.0" WUXGA	Camera	HD 2600 512M	2 x 250GB	Blu-ray	*Intel 11n	Blue	Game	Home Prem	May 08

- 17.0" widescreen, glossy display
- Frameless screen (no plastic frame) to extend to the edges of the PC
- Blue metallic finish
- Game Zone with secondary display, user-defined keys, performance control switch and enlarged direction keys on select models
- Integrated 1.3 megapixel camera and Lenovo's VeriFace face recognition software helps control access to your notebook by recognizing your face.
- Dolby® Home Theater™ premium audio system with four speakers and one subwoofer
- HDMI port, HDCP-compliant
- Hot-swap secondary disk capability on select models



Positioning Processor	Widescreen flexibility Intel® Core™ 2 Duo processor T5550 or T5750 with dual-core, Intel 64 Technology, 667MHz system bus, and 2MB L2 cache or Intel Core 2 Duo processor T8100 with dual-core, Intel 64 Technology, Intel Dynamic Acceleration, 800MHz bus, and 3MB L2 cache or Intel Core 2 Extreme processor X9000 with dual-core, Intel 64 Technology, 800MHz bus, and 6MB L2 cache	Preloaded operating system ²⁰ - Microsoft® Windows® Vista® Home Premium Edition (32-bit) ◇ Vista Premium logo
Memory	2GB or 4GB std / 4GB max ⁷ / PC2-5300 667MHz DDR2, non-parity, dual-channel capable, two 200-pin SO-DIMM sockets; <i>Italics:</i> standard memory in both sockets; no sockets available	Preloaded applications ¹⁴ • Lenovo™ OneKey Recovery • Norton® AntiVirus 2007 (90 days of virus definitions) • Adobe® Reader • Windows Live™ Toolbar • Easy Capture • Microsoft Office 2007 Trial (60-day) • VeriFace™ Facial Recognition • EarthLink® • Energy Cut • Lenovo Shuttle Center (DVD±RW, Blu-ray) • Cyberlink Power2Go (DVD±RW, Blu-ray)
Diskette drive	None (use optional USB-based diskette drive)	
EIDE DVD±RW	<i>Some:</i> DVD burner, dual-layer support, fixed, not removable, 12.7mm, tray-in	
EIDE Blu-ray™	<i>Some:</i> Blu-ray Disc reader (no Blu-ray media burning), BD-ROM, no HD-DVD playback, DVD and CD recordable, not removable, 12.7mm high, tray-in	
SATA disk	250GB (5400 rpm) / SATA 1.5Gb/s, 9.5mm high, removable and upgradable	
Secondary disk	<i>Some:</i> 250GB (5400 rpm) / SATA 1.5Gb/s, 9.5mm high, removable and upgradable, hot-swap support, external support via USB cable	
Widescreen display	<i>Some:</i> 17.0" (431.8mm) WXGA+ (1440x900) TFT color, 200 nits <i>Some:</i> 17.0" (431.8mm) WUXGA (1920x1200) TFT color, 300 nits <i>All:</i> VibrantView (glossy), CCFL backlight, 16:10 aspect ratio, 500:1 contrast ratio, frameless screen	
Camera	Camera on top of screen, 1.3-megapixel, fixed focus	
Graphics	ATI™ Mobility Radeon™ HD 2600, PCI Express® x16, DirectX® 10, ATI Avivo™, VGA connector (with VGA-in support), HDMI connector, HDCP-compliant, 256MB or 512MB graphic memory	
Keyboard	Full-size keyboard, 6-row, 84-key, multimedia Fn keys	
Numeric keypad	<i>Some:</i> Numeric keypad on right of keyboard	
Game Zone	<i>Some:</i> Secondary display, user-defined keys, performance switch, enlarged direction keys	
Multimedia controls	Touch-sensitive audio-video control panel, Shuttle Key	
Touch pad	Two-button touch pad with scroll feature (no TrackPoint®)	
Dimensions ³	(WxDxH): 15.5" x 11.2" x 1.02" to 1.53"; 395mm x 285mm x 26 to 39mm	
Weight ²	with optical drive and battery: 7.9 lb (3.6 kg)	
Case color	Blue top, black bottom	
Case material	ABS plastic	
Battery - type	Lithium Ion 6-cell, 5200 mAh, smart battery, 5-bar battery indicator	
Battery - life ¹⁰	Up to 3.5 hr	Available at these retailers • lenovo.com
Chipset	Mobile Intel GM965 Express Chipset (Graphics Memory Controller Hub); ICH8M I/O Controller Hub (SATA 3.0Gb/s, ATA-100 EIDE, USB 2.0, PCI Express 1.1, PCI 2.3), LPC bus	135-watt AC adapter Wireless on/off switch VGA in/out switch ENERGY STAR® 4.0-compliant RoHS-compliant
ExpressCard/54 Multicard reader	One slot (ExpressCard/34, ExpressCard/54) 6-in-1 reader (MultiMedia Card, Memory Stick, Memory Stick PRO™, Secure Digital Card, Secure Digital Elite Pro Card, xD-Picture Card™)	
Ports	Four USB 2.0, external monitor (VGA DB-15, HDMI), S-video, modem (RJ-11), ethernet (RJ-45), IEEE 1394 FireWire 400 (4-pin connector; 1394a-2000 standard)	Limited Warranty¹² ⇒ 1-year parts and labor ⇒ Depot repair service ¹⁹ ⇒ Service upgrade options (in eligible locations): ⁹ • 1-year accidental damage protection via depot 43R8885 • 3-year Lenovo Onsite Repair ¹³ 9x5 Next Business Day 43R8883 • 3-year Lenovo Onsite Repair ¹³ 9x5 Next Business Day with accidental damage protection 43R8884 ⇒ 24x7 ¹⁶ toll-free support for warranty issues during the warranty period ¹² via 877-453-6686
TV tuner	None	
Mini PCI Express Intel 11n ²⁸	One Mini PCI Express slot 11a/b/g/n wireless ⁴ , Mini PCIe adapter, Intel Wireless WiFi Link 4965AGN, MIMO 2x3 (Kedron)	
Bluetooth™	Bluetooth 2.0 wireless, USB 2.0 interface via ICH8M, LED indicator	
Modem	56K V.92 ⁶ modem	
Ethernet	10/100 ethernet, Broadcom® BCM5906M, PCI 2.3	
Audio support	Intel High Definition (HD) Audio, RealTek® ALC888S codec / two main speakers (2 watt), two secondary speakers (1.5 watt) and subwoofer (3 watt), Dolby Home Theater Speaker System / stereo microphone, microphone input jack (3.5 mm), stereo headphone jack (3.5 mm)	
Security	Power-on password, hard disk password, supervisor password, security keyhole, VeriFace facial recognition software	
Fingerprint reader	None	

See footnotes for important warranty information

* Intel Centrino® processor technology

Ⓢ US model announced August 12, 2008; previous models on April 29, 2008



Lenovo IdeaPad Y730
Valencia Orange



Lenovo IdeaPad Y730
Valencia Orange



Lenovo IdeaPad Y730



Lenovo IdeaPad Y730
Dark Blue, Glossy Finish



Lenovo IdeaPad Y730
Valencia Orange



Lenovo IdeaPad Y730
Valencia Orange

Type-model	Processor	GHz	Memory	Widescreen display	Camera	Integrated graphics	SATA disk(s)	SATA optical	Mini PCIe 802.11 wireless	Top color	Blue-tooth	Keypad / Game Zone	Vista preload	Avail date
4053-2DU	T3200	2.00	2GB	17.0" WXGA+	Cam	GMA	1 x 160GB ⁸	DVD±RW	Intel 5100 ²⁸	Blue	None	Keypad	Prem 32	Sep 08
<ul style="list-style-type: none"> • 17.0" widescreen, glossy display • Integrated 1.3 megapixel camera and Lenovo's VeriFace face recognition software helps control access to your notebook by recognizing your face. • Dolby® Home Theater™ premium audio system with four speakers and one subwoofer • HDMI port, HDCP-compliant • Lenovo Rescue System provides OneKey recovery and OneKey Antivirus without booting into Windows 														
Positioning Processor	Widescreen flexibility Intel® Pentium® dual-core processor T3200 with dual-core, 667MHz system bus, and 1MB L2 cache										Preloaded operating system²⁰ - Microsoft® Windows® Vista® Home Premium Edition (32-bit) ↕ Vista Premium logo Preloaded applications¹⁴ • Lenovo™ OneKey Recovery • Lenovo ReadyComm • Norton Internet Security™ (90 days of virus definitions) • Adobe® Reader • Windows Live™ Toolbar • Easy Capture • Microsoft Office 2007 Trial (60-day) • Napster™ To Go® • WildGames™ • Carbonite Online Backup • VeriFace™ Facial Recognition • Lenovo Energy Management Software • Cyberlink Power2Go (DVD±RW)			
Memory	2GB std / 4GB max ⁷ / PC3-8500 1066MHz DDR3 , non-parity, dual-channel capable, two 204-pin SO-DIMM sockets; <i>Italics:</i> standard memory in both sockets; no sockets available													
SATA DVD±RW	DVD burner, dual-layer support, fixed, not removable, 12.7mm, tray-in													
Primary SATA disk	160GB (5400 rpm) / SATA 1.5Gb/s, 9.5mm high, removable, upgradable													
Second SATA disk	None													
Disk bays	Two internal disk bays, 9.5mm high													
Widescreen display	17.0" (431.8mm) WXGA+ (1440x900) TFT color, VibrantView (glossy) CCFL backlight, 200 nits, 16:10 aspect ratio, 500:1 contrast ratio													
Camera	Camera on top of screen, 1.3-megapixel, fixed focus													
Integrated graphics	Intel Graphics Media Accelerator 4500MHD (GMA 4500MHD) , in GM45, HDMI port supporting HDCP to output protected content													
Keyboard	Full-size keyboard, 6-row, 84-key, multimedia Fn keys													
Numeric keypad	Numeric keypad on right of keyboard													
Game Zone	None													
Multimedia controls	Touch-sensitive audio-video control panel, Shuttle Key													
Touch pad	Two-button touch pad with scroll feature (no TrackPoint®)													
Dimensions ³	(WxDxH): 15.5" x 11.2" x 1.22" to 1.53"; 395mm x 285mm x 31 to 39mm													
Weight ²	with optical drive and battery: 7.9 lb (3.6 kg)													
Case color	<i>Top:</i> dark blue, flat finish; <i>Bottom:</i> black													
Case material	ABS plastic													
Battery - type	Lithium Ion 6-cell , 5200 mAh, smart battery, 5-bar battery indicator													
Battery - life ¹⁰	Up to 3.5 hr										Available at these retailers • lenovo.com			
Chipset	Mobile Intel GM45 Express Chipset (Graphics Memory Controller Hub), ICH9M I/O Controller Hub (SATA 3.0Gb/s, USB 2.0, PCI Express® 1.1, PCI 2.3, ethernet MAC)										135-watt AC adapter Wireless on/off switch RoHS-compliant			
ExpressCard/54 Multicard reader	One ExpressCard/34 or ExpressCard/54													
Ports	6-in-1 reader (MultiMedia Card, Memory Stick, Memory Stick PRO™, Secure Digital Card, Secure Digital Elite Pro Card, xD-Picture Card™), Four USB 2.0, external monitor (VGA DB-15, HDMI), ethernet (RJ-45), IEEE 1394 FireWire 400 (4-pin connector; 1394a-2000 standard)										Limited Warranty¹² ↕ 1-year parts and labor ↕ Depot repair service¹⁹ ↕ Service upgrade options (in eligible locations):⁹ <ul style="list-style-type: none"> • 1-year accidental damage protection via depot 43R8885 • 3-year Lenovo Onsite Repair¹³ 9x5 Next Business Day 43R8883 • 3-year Lenovo Onsite Repair¹³ 9x5 Next Business Day with accidental damage protection 43R8884 ↕ 24x7¹⁶ toll-free support for warranty issues during the warranty period¹² via 877-453-6686			
TV tuner	None													
Mini PCI Express	One Mini PCI Express slot													
Intel 5100 ²⁸	11a/b/g/n wireless ⁴ , Mini PCIe adapter, Intel WiFi Link 5100, 1x2 (Shirley Peak)													
Bluetooth™	None													
Modem	None													
Ethernet	10/100 ethernet, Broadcom® BCM5906M, PCI 2.3													
Audio support	Intel High Definition (HD) Audio, RealTek® ALC888S codec / two main speakers (2 watt), two secondary speakers (1.5 watt) and subwoofer (3 watt), Dolby Home Theater Speaker System / dual array microphone, microphone input jack (3.5 mm), headphone jack (3.5 mm)													
Security	Power-on password, hard disk password, supervisor password, security keyhole, VeriFace facial recognition software													
Fingerprint reader	None													

See footnotes for important warranty information
US model announced September 16, 2008

© Lenovo
(MB2-2) September 2008

Part number	Processor	GHz	Memory	Widescreen display	Camera	Discrete graphics	SATA disk(s)	SATA optical	Mini PCIe 802.11 wireless	Top color	Keypad / Game Zone	ENERGY STAR 4.0	Vista preload	Avail date
59016615	T3200	2.00	2GB	17.0" WXGA+	Cam	HD 3650	1 x 250GB ⁸	DVD±RW	Intel 5100 ²⁸	Blue	Keypad		Prem 32	Nov 08
59016609	T3200	2.00	3GB	17.0" WXGA+	Cam	HD 3650	1 x 160GB	DVD±RW	Intel 5100	Blue	Keypad		Prem 32	Nov 08
59016799	T3200	2.00	3GB	17.0" WXGA+	Cam	HD 3650	1 x 160GB	DVD±RW	Intel 5100	Blue	Keypad		Prem 32	Nov 08
59016821	T5800	2.00	4GB	17.0" WXGA+	Cam	HD 3650	1 x 250GB	DVD±RW	* Intel 5100	Blue	Keypad		Prem 64	Nov 08
59016620	T5800	2.00	4GB	17.0" WXGA+	Cam	HD 3650	1 x 250GB	DVD±RW	* Intel 5100	Blue	Keypad		Prem 64	Dec 08
59016437	P8400	2.26	4GB	17.0" WXGA+	Cam	HD 3650	1 x 320GB	DVD±RW	‡ Intel 5100	Blue	Keypad	ES40	Prem 64	Oct 08

- 17.0" widescreen, glossy display
- Halo lighting that changes color based on processor speed or customer preferences
- Dark blue color with glossy piano finish
- Integrated 1.3 megapixel camera and Lenovo's VeriFace face recognition software helps control access to your notebook by recognizing your face.
- Dolby® Home Theater™ premium audio system with four speakers and one subwoofer
- Lenovo Rescue System provides OneKey recovery and OneKey Antivirus without booting into Windows

Processor	Intel® Pentium® dual-core processor T3200 with dual-core, 667MHz system bus, and 1MB L2 cache or Intel Core™ 2 Duo processor T5800 with dual-core, 800MHz system bus, and 2MB L2 cache or Intel Core 2 Duo processor P8400 with dual-core, Intel HD Boost, 1066MHz system bus, and 3MB L2 cache	Preloaded operating system ²⁰ - Some: Microsoft® Windows® Vista® Home Premium Edition (32-bit) - Some: Microsoft Windows Vista Home Premium Edition (64-bit) ‡ Vista Premium logo
Memory	2GB, 3GB, or 4GB std / 4GB max ⁷ / PC3-8500 1066MHz DDR3, non-parity, dual-channel capable, two 204-pin SO-DIMM sockets; <i>Italics:</i> standard memory in both sockets; no sockets available	Preloaded applications ¹⁴ (only some listed) • Lenovo™ OneKey Recovery • Lenovo ReadyComm • Norton Internet Security™ (90 days of virus definitions) • Adobe® Reader • Windows Live™ Toolbar • Easy Capture • Microsoft Office 2007 Trial (60-day) • VeriFace™ Facial Recognition • Lenovo Energy Management Software • Cyberlink Power2Go (DVD±RW, Blu-ray)
SATA DVD±RW	DVD burner, dual-layer support, fixed, not removable, 12.7mm, tray-in	Available at these retailers • B&H™ • J&R™ • TigerDirect • Supercom (Canada)
Primary SATA disk	160 (5400 rpm), 250 (5400 rpm), or 320GB (5400 rpm) / SATA 1.5Gb/s, 9.5mm high, removable, upgradable	
Second SATA disk	None	135-watt AC adapter Wireless on/off switch VGA in/out switch Some: ENERGY STAR® 4.0-compliant RoHS-compliant
Disk bays	Two internal disk bays, 9.5mm high	
Widescreen display	17.0" (431.8mm) WXGA+ (1440x900) TFT color, VibrantView (glossy), CCFL backlight, 200 nits, 16:10 aspect ratio, 500:1 contrast ratio, frameless screen	Limited Warranty¹² ⇨ 1-year parts and labor ⇨ Depot repair service ¹⁹ ⇨ Service upgrade options (in eligible locations): ⁹ • 1-year accidental damage protection via depot 43R8885 • 3-year Lenovo Onsite Repair ¹³ 9x5 Next Business Day 43R8883 • 3-year Lenovo Onsite Repair ¹³ 9x5 Next Business Day with accidental damage protection 43R8884 ⇨ 24x7 ¹⁶ toll-free support for warranty issues during the warranty period ¹² via 877-453-6686
Camera	Camera on top of screen, 1.3-megapixel, fixed focus	
Discrete graphics	ATI™ Mobility Radeon™ HD 3650, PCI Express® x16, 512MB memory, DirectX® 10, ATI Avivo™ HD, VGA connector (with VGA-in support), HDMI connector, HDCP-compliant	
Keyboard	Full-size keyboard, 6-row, 84-key, multimedia Fn keys	
Numeric keypad	Numeric keypad on right of keyboard	
Multimedia controls	Touch-sensitive audio-video control panel, Shuttle Key	
Touch pad	Two-button touch pad with scroll feature (no TrackPoint®)	
Dimensions ³	(WxDxH): 15.5" x 11.2" x 1.22" to 1.53"; 395mm x 285mm x 31 to 39mm	
Weight ²	with optical drive and battery: 7.9 lb (3.6 kg)	
Case color	Top: dark blue, glossy finish; Bottom: black	
Case material	ABS plastic	
Battery - type	Lithium Ion 6-cell, 5200 mAh, smart battery, 5-bar battery indicator	
Battery - life ¹⁰	Up to 3.5 hr	
Chipset	Mobile Intel GM45 Express Chipset (Graphics Memory Controller Hub), ICH9M I/O Controller Hub (SATA 3.0Gb/s, USB 2.0, PCI Express 1.1, PCI 2.3, ethernet MAC)	
ExpressCard/54 Multicard reader	One slot (ExpressCard/34, ExpressCard/54) 6-in-1 reader (MultiMedia Card, Memory Stick, Memory Stick PRO™, Secure Digital Card, Secure Digital Elite Pro Card, xD-Picture Card™)	
Ports	Four USB 2.0, external monitor (VGA DB-15, HDMI), modem (RJ-11), ethernet (RJ-45), IEEE 1394 FireWire 400 (4-pin connector; 1394a-2000 standard)	
TV tuner	None	
Mini PCI Express	Three Mini PCI Express slots	
Intel 5100 ²⁸	11a/b/g/n wireless ⁴ , Mini PCIe adapter, Intel WiFi Link 5100, 1x2 (Shirley Peak)	
Bluetooth™	Bluetooth 2.1 wireless, USB 2.0 interface via ICH9M, LED indicator	
Modem	56K V.92 ⁶ modem	
Ethernet	10/100 ethernet, Broadcom® BCM5906M, PCI 2.3	
Audio support	Intel High Definition (HD) Audio, RealTek® ALC888S codec / two main speakers (2 watt), two secondary speakers (1.5 watt) and subwoofer (3 watt), Dolby Home Theater Speaker System / dual array microphone, microphone input jack (3.5 mm), headphone jack (3.5 mm)	
Security	Power-on password, hard disk password, supervisor password, security keyhole, VeriFace facial recognition software	
Fingerprint reader	None	

See footnotes for important warranty information

* Intel Centrino® processor technology

© Lenovo

‡ US model announced December 10, 2008;

‡ Intel Centrino 2 processor technology

(MB2-3) December 2008

previous models on October 22 or November 12, 2008

Type-model	Processor	GHz	Memory	Widescreen display	Discrete graphics	VGA-in	SATA disk(s)	SATA optical	Mini PCIe 802.11 wireless	Top color	Keypad / Game Zone	ENERGY STAR 4.0	Vista preload	Avail date
4053-2FU	T5800	2.00	2GB	17.0" WXGA+	HD 3650	VGA-in	1 x 320GB ⁸	DVD±RW *	Intel 5100 ²⁸	Blue	Keypad		Prem 32	Sep 08
4053-2GU	T5800	2.00	3GB	17.0" WXGA+	HD 3650	VGA-in	1 x 320GB	DVD±RW *	Intel 5100	Blue	Keypad		Prem 32	Sep 08
4053-2CU	P7350	2.00	3GB	17.0" WXGA+	HD 3650	VGA-in	1 x 320GB	DVD±RW †	Intel 5100	Blue	Keypad	ES40	Prem 64	Aug 08
4053-2BU	P8400	2.26	3GB	17.0" WXGA+	HD 3650	VGA-in	1 x 320GB	DVD±RW †	Intel 5100	Blue	Keypad	ES40	Prem 64	Aug 08
4053-2AU	P8400	2.26	4GB	17.0" WUXGA	HD 3650		1 x 320GB	DVD±RW †	Intel 5100	Orange	Game	ES40	Prem 64	Aug 08
4053-2EU	X9100	3.06	4GB	17.0" WUXGA	HD 3650		2 x 320GB	Blu-ray †	Intel 5100	Orange	Game		Prem 64	Sep 08

- 17.0" widescreen, glossy display
- Halo lighting that changes color based on processor speed or customer preferences
- Dark blue or valencia orange color with glossy piano finish
- Game Zone with secondary display, user-defined keys, performance control switch and enlarged direction keys on select models
- Integrated 1.3 megapixel camera and Lenovo's VeriFace face recognition software helps control access to your notebook by recognizing your face.
- Dolby® Home Theater™ premium audio system with four speakers and one subwoofer
- Hot-swap secondary disk capability on select models
- Lenovo Rescue System provides OneKey recovery and OneKey Antivirus without booting into Windows

Processor	Intel® Core™ 2 Duo processor T5800 with dual-core, 800MHz system bus, and 2MB L2 cache or Intel Core 2 Duo processor P7350 or P8400 with dual-core, Intel HD Boost, 1066MHz system bus, and 3MB L2 cache or Intel Core 2 Extreme processor X9100 with dual-core, Intel HD boost, 1066MHz system bus, and 6MB L2 cache	Preloaded operating system ²⁰ - Some: Microsoft® Windows® Vista® Home Premium Edition (32-bit) - Some: Microsoft Windows Vista Home Premium Edition (64-bit) ♦ Vista Premium logo
Memory	2GB, 3GB, or 4GB std / 4GB max ⁷ / PC3-8500 1066MHz DDR3, non-parity, dual-channel capable, two 204-pin SO-DIMM sockets; <i>Italics:</i> standard memory in both sockets; no sockets available	Preloaded applications ¹⁴ • Lenovo™ OneKey Recovery • Lenovo ReadyComm • Lenovo Idea Central (Premium 64-bit models only) • Lenovo Idea Notes (Premium 64-bit models only) • Norton Internet Security™ (90 days of virus definitions) • Adobe® Reader • Windows Live™ Toolbar • Easy Capture • Microsoft Office 2007 Trial (60-day) • Napster™ To Go® (Premium 32-bit models only) • WildGames™ • Carbonite Online Backup • VeriFace™ Facial Recognition • Lenovo Energy Management Software • Cyberlink Power2Go (DVD±RW, Blu-ray)
SATA DVD±RW SATA Blu-ray™	Some: DVD burner, dual-layer support, fixed, not removable, 12.7mm, tray-in Some: Blu-ray Disc reader (no Blu-ray media burning), BD-ROM, no HD-DVD playback, DVD recordable, not removable, 12.7mm high, tray-in	Available at these retailers • lenovo.com
Primary SATA disk	320GB (5400 rpm) / SATA 1.5Gb/s, 9.5mm high, removable, upgradable	135-watt AC adapter Wireless on/off switch Some: VGA in/out switch Some: ENERGY STAR® 4.0-compliant RoHS-compliant
Second SATA disk	Some: 320GB (5400 rpm) / SATA 1.5Gb/s, 9.5mm high, removable and upgradable, hot-swap support, external support via USB cable	Limited Warranty ¹² ⇒ 1-year parts and labor ⇒ Depot repair service ¹⁹ ⇒ Service upgrade options (in eligible locations): ⁹ • 1-year accidental damage protection via depot 43R8885 • 3-year Lenovo Onsite Repair ¹³ 9x5 Next Business Day 43R8883 • 3-year Lenovo Onsite Repair ¹³ 9x5 Next Business Day with accidental damage protection 43R8884 ⇒ 24x7 ¹⁶ toll-free support for warranty issues during the warranty period ¹² via 877-453-6686
Disk bays	Two internal disk bays, 9.5mm high	
Widescreen display	Some: 17.0" (431.8mm) WXGA+ (1440x900) TFT color, 200 nits Some: 17.0" (431.8mm) WUXGA (1920x1200) TFT color, 300 nits All: VibrantView (glossy), 16:10 aspect ratio, 500:1 contrast, frameless screen	
Camera	Camera on top of screen, 1.3-megapixel, fixed focus	
Discrete graphics	ATI™ Mobility Radeon™ HD 3650, PCI Express® x16, 512MB memory, DirectX® 10, ATI Avivo™ HD, VGA connector (with VGA-in support on some models), HDMI connector, HDCP-compliant	
Keyboard Numeric keypad Game Zone	Full-size keyboard, 6-row, 84-key, multimedia Fn keys Some: Numeric keypad on right of keyboard Some: Secondary display, user-defined keys, performance switch, enlarged direction keys	
Multimedia controls Touch pad	Touch-sensitive audio-video control panel, Shuttle Key Two-button touch pad with scroll feature (no TrackPoint®)	
Dimensions ³ Weight ² Case color Case material Battery - type Battery - life ¹⁰	(WxDxH): 15.5" x 11.2" x 1.22" to 1.53"; 395mm x 285mm x 31 to 39mm with optical drive and battery: 7.9 lb (3.6 kg) Top: dark blue or valencia orange, glossy finish; Bottom: black ABS plastic Lithium Ion 6-cell, 5200 mAh, smart battery, 5-bar battery indicator Up to 3.5 hr	
Chipset	Mobile Intel GM45 Express Chipset (Graphics Memory Controller Hub), ICH9M I/O Controller Hub (SATA 3.0Gb/s, USB 2.0, PCI Express 1.1, PCI 2.3, ethernet MAC)	
ExpressCard/54 Multicard reader	One ExpressCard/34 or ExpressCard/54 6-in-1 reader (MultiMedia Card, Memory Stick, Memory Stick PRO™, Secure Digital Card, Secure Digital Elite Pro Card, xD-Picture Card™)	
Ports	Four USB 2.0, external monitor (VGA DB-15, HDMI), modem (RJ-11), ethernet (RJ-45), IEEE 1394 FireWire 400 (4-pin connector; 1394a-2000 standard)	
TV tuner	None	
Mini PCI Express	Three Mini PCI Express slots	
Intel 5100 ²⁸	11a/b/g/n wireless*, Mini PCIe adapter, Intel WiFi Link 5100, 1x2 (Shirley Peak)	
Bluetooth™	Bluetooth 2.1 wireless, USB 2.0 interface via ICH9M, LED indicator	
Modem	56K V.92 ⁶ modem	
Ethernet	10/100 ethernet, Broadcom® BCM5906M, PCI 2.3	
Audio support	Intel High Definition (HD) Audio, RealTek® ALC888S codec / two main speakers (2 watt), two secondary speakers (1.5 watt) and subwoofer (3 watt), Dolby Home Theater Speaker System / dual array microphone, microphone input jack (3.5 mm), headphone jack (3.5 mm)	
Security	Power-on password, hard disk password, supervisor password, security keyhole, VeriFace facial recognition software	
Fingerprint reader	None	

See footnotes for important warranty information
²⁸ US models announced September 16, 2008; previous models on August 19, 2008

* Intel Centrino® processor technology
 † Intel Centrino 2 processor technology

Type-model	Processor	GHz	Memory	Widescreen display	Discrete graphics	VGA-in	SATA disk(s)	SATA optical	Mini PCIe 802.11 wireless	Top color	Keypad / Game Zone	ENERGY STAR 4.0	Vista preload	Avail date
4053-33U	P7350	2.00	4GB	17.0" WUXGA	HD 3650		1 x 320GB ⁸	DVD±RW	Intel 5100 ²⁸	Orange	Game	ES40	Prem 64	Nov 08
4053-35U	P8400	2.26	4GB	17.0" WXGA+	HD 3650	VGA-in	1 x 320GB	DVD±RW	Intel 5100	Blue	Keypad	ES40	Prem 64	Nov 08
4053-32U	P8600	2.40	3GB	17.0" WUXGA	HD 3650		1 x 320GB	DVD±RW	Intel 5100	Orange	Game	ES40	Prem 32	Nov 08
4053-34U	T9400	2.53	4GB	17.0" WUXGA	HD 3650		2 x 320GB	Blu-ray	Intel 5100	Orange	Game	ES40	Prem 64	Nov 08

- 17.0" widescreen, glossy display
- Halo lighting that changes color based on processor speed or customer preferences
- Dark blue or valencia orange color with glossy piano finish
- Game Zone with secondary display, user-defined keys, performance control switch and enlarged direction keys on select models
- Integrated 1.3 megapixel camera and Lenovo's VeriFace face recognition software helps control access to your notebook by recognizing your face.
- Dolby® Home Theater™ premium audio system with four speakers and one subwoofer
- Hot-swap secondary disk capability on select models
- Lenovo Rescue System provides OneKey recovery and OneKey Antivirus without booting into Windows

Processor	Intel® Core™ 2 Duo processor P7350, P8400, P8600, or T9400 with dual-core, Intel HD Boost, 1066MHz system bus; P7350/P8400/P8600: 3MB L2 cache; T9400: 6MB L2 cache	Preloaded operating system²⁰ - Some: Microsoft® Windows® Vista® Home Premium Edition (32-bit) - Some: Microsoft Windows Vista Home Premium Edition (64-bit) ♦ Vista Premium logo Preloaded applications¹⁴ • Lenovo™ OneKey Recovery • Lenovo ReadyComm • Lenovo Idea Central (Premium 64-bit models only) • Lenovo Idea Notes (Premium 64-bit models only) • Norton Internet Security™ (90 days of virus definitions) • Adobe® Reader • Windows Live™ Toolbar • Easy Capture • Microsoft Office 2007 Trial (60-day) • Napster™ To Go® (Premium 32-bit models only) • WildGames™ • Carbonite Online Backup • VeriFace™ Facial Recognition • Lenovo Energy Management Software • Cyberlink Power2Go (DVD±RW, Blu-ray)
Memory	3GB or 4GB std / 4GB max ⁷ / PC3-8500 1066MHz DDR3, non-parity, dual-channel capable, two 204-pin SO-DIMM sockets; <i>Italics:</i> standard memory in both sockets; no sockets available	
SATA DVD±RW	<i>Some:</i> DVD burner, dual-layer support, fixed, not removable, 12.7mm, tray-in	
SATA Blu-ray™	<i>Some:</i> Blu-ray Disc reader (no Blu-ray media burning), BD-ROM, no HD-DVD playback, DVD recordable, not removable, 12.7mm high, tray-in	
Primary SATA disk	320GB (5400 rpm) / SATA 1.5Gb/s, 9.5mm high, removable, upgradable	
Second SATA disk	<i>Some:</i> 320GB (5400 rpm) / SATA 1.5Gb/s, 9.5mm high, removable and upgradable, hot-swap support, external support via USB cable	
Disk bays	Two internal disk bays, 9.5mm high	
Widescreen display	<i>Some:</i> 17.0" (431.8mm) WXGA+ (1440x900) TFT color, 200 nits <i>Some:</i> 17.0" (431.8mm) WUXGA (1920x1200) TFT color, 300 nits <i>All:</i> VibrantView (glossy), 16:10 aspect ratio, 500:1 contrast ratio	
Camera	Camera on top of screen, 1.3-megapixel, fixed focus	
Discrete graphics	ATI™ Mobility Radeon™ HD 3650, PCI Express® x16, 512MB memory, DirectX® 10, ATI Avivo™ HD, VGA connector (with VGA-in support on some models), HDMI connector, HDCP-compliant	
Keyboard	Full-size keyboard, 6-row, 84-key, multimedia Fn keys	
Numeric keypad	<i>Some:</i> Numeric keypad on right of keyboard	
Game Zone	<i>Some:</i> Secondary display, user-defined keys, performance switch, enlarged direction keys	
Multimedia controls	Touch-sensitive audio-video control panel, Shuttle Key	
Touch pad	Two-button touch pad with scroll feature (no TrackPoint®)	
Dimensions ³	(WxDxH): 15.5" x 11.2" x 1.22" to 1.53"; 395mm x 285mm x 31 to 39mm	
Weight ²	with optical drive and battery: 7.9 lb (3.6 kg)	
Case color	Top: dark blue or valencia orange, glossy finish; Bottom: black	
Case material	ABS plastic	
Battery - type	Lithium Ion 6-cell, 5200 mAh, smart battery, 5-bar battery indicator	
Battery - life ¹⁰	Up to 3.5 hr	
Chipset	Mobile Intel GM45 Express Chipset (Graphics Memory Controller Hub), ICH9M I/O Controller Hub (SATA 3.0Gb/s, USB 2.0, PCI Express 1.1, PCI 2.3, ethernet MAC)	135-watt AC adapter Wireless on/off switch <i>Some:</i> VGA in/out switch ENERGY STAR® 4.0-compliant RoHS-compliant Limited Warranty¹² ⇨ 1-year parts and labor ⇨ Depot repair service ¹⁹ ⇨ Service upgrade options (in eligible locations): ⁹ <ul style="list-style-type: none"> • 1-year accidental damage protection via depot 43R8885 • 3-year Lenovo Onsite Repair¹³ 9x5 Next Business Day 43R8883 • 3-year Lenovo Onsite Repair¹³ 9x5 Next Business Day with accidental damage protection 43R8884 ⇨ 24x7 ¹⁶ toll-free support for warranty issues during the warranty period ¹² via 877-453-6686
ExpressCard/54	One slot (ExpressCard/34, ExpressCard/54)	
Multicard reader	6-in-1 reader (MultiMedia Card, Memory Stick, Memory Stick PRO™, Secure Digital Card, Secure Digital Elite Pro Card, xD-Picture Card™)	
Ports	Four USB 2.0, external monitor (VGA DB-15, HDMI), modem (RJ-11), ethernet (RJ-45), IEEE 1394 FireWire 400 (4-pin connector; 1394a-2000 standard)	
TV tuner	None	
Mini PCI Express	Three Mini PCI Express slots	
Intel 5100 ²⁸	11a/b/g/n wireless ⁴ , Mini PCIe adapter, Intel WiFi Link 5100, 1x2 (Shirley Peak)	
Bluetooth™	Bluetooth 2.1 wireless, USB 2.0 interface via ICH9M, LED indicator	
Modem	56K V.92 ⁶ modem	
Ethernet	10/100 ethernet, Broadcom® BCM5906M, PCI 2.3	
Audio support	Intel High Definition (HD) Audio, RealTek® ALC888S codec / two main speakers (2 watt), two secondary speakers (1.5 watt) and subwoofer (3 watt), Dolby Home Theater Speaker System / dual array microphone, microphone input jack (3.5 mm), headphone jack (3.5 mm)	
Security	Power-on password, hard disk password, supervisor password, security keyhole, VeriFace facial recognition software	
Fingerprint reader	None	

See footnotes for important warranty information
 US models announced November 12, 2008

⇨ Intel Centrino® 2 processor technology

**Partial list of accessories supported on:
IdeaPad S10, U110, U330, Y430, Y510, Y530, Y710, and Y730****Memory***U110, Y510, and Y710*1GB Y-Series PC2-5300 DDR2 SODIMM 43R1979 *ann 09/25/07***Storage and removable storage**USB 2.0 MyKey E10 Flash Drive 1GB 45J7701 *ann 04/29/08*USB 2.0 MyKey E10 Flash Drive 2GB 45J7702 *ann 04/29/08*USB 2.0 MyKey E10 Flash Drive 4GB 45J7703 *ann 04/29/08*USB 2.0 MiniKey M10D1 Flash 2GB (gray) 45J7752 *ann 05/20/08*USB 2.0 MiniKey M10D2 Flash 2GB (black) 45J7754 *ann 05/20/08*USB 2.0 MiniKey M10E1 Flash 2GB (teal) 45J7756 *ann 05/20/08*USB 2.0 MiniKey M10E2 Flash 2GB (pink) 45J7758 *ann 05/20/08*USB 2.0 Essential Memory Key 1GB 41U4940 *ann 01/23/07*USB 2.0 Essential Memory Key 2GB 41U4944 *ann 01/23/07*USB 2.0 Essential Memory Key 4GB 45J7904 *ann 06/24/08*USB 2.0 Essential Memory Key 8GB 45J7905 *ann 07/15/08*USB 2.0 Security Memory Key 1GB 41U5118 *ann 07/17/07*USB 2.0 Security Memory Key 2GB 41U5119 *ann 07/17/07*USB 2.0 Security Memory Key 4GB 41U5120 *ann 07/17/07*USB 2.0 DataSlim E16 Portable HD 160GB 45J7700 *ann 04/29/08*USB 2.0 Portable 160GB Hard Disk 43R1784 *ann 09/23/08*USB 2.0 Portable Secure 160GB Hard Disk 43R2018 *ann 11/18/08*USB 2.0 Portable Secure 320GB Hard Disk 43R2019 *ann 11/18/08***Keyboard**Preferred Pro USB Keyboard 73P5220 *ann 06/21/05*Enhanced Performance USB Keyboard 73P2620 *ann 03/23/04*Wireless Kybd & Opt Wheel Mouse (via USB) 73P4067 *ann 12/07/04*USB Keyboard with UltraNav 31P8950 *ann 01/28/03*USB Travel Keyboard with UltraNav 31P9490 *ann 04/27/04***Mouse**Laser Tilt Wheel Mouse (USB, PS/2) 41U3074 *ann 01/23/07*IdeaPad Mini Optical Mouse M10 (black) 47J7729 *ann 06/17/08*IdeaPad Mini Optical Mouse M10A (black) 45J7730 *ann 07/15/08*Lenovo® Mini Optical Mouse M30 (black) 47J7735 *ann 06/17/08*Lenovo Mini Optical Mouse M30 (white) 47J7736 *ann 06/17/08*Lenovo Mini Optical Mouse M30 (red) 47J7737 *ann 06/17/08*Lenovo Mini Optical Mouse M30 (blue) 47J7738 *ann 06/17/08*Mini Wireless Laser Mouse N10 (black) 45J7731 *ann 06/17/08*Mini Wireless Laser Mouse N10 (red) 45J7732 *ann 06/17/08***Batteries****S10**IdeaPad S9/S10 Li-Ion Battery 6-cell (white) 45K2177 *ann 12/16/08*IdeaPad S9/S10 Li-Ion Battery 6-cell (black) 45K2178 *ann 12/16/08**Y510, Y530, Y710, and Y730*Lenovo Y510/Y710 Li-Ion Battery 6-cell 45J7706 *ann 04/29/08***S10**IdeaPad S9/S10 40W AC Adapter (white) 45K2200 *ann 11/18/08*IdeaPad S9/S10 40W AC Adapter (black) 45K2209 *ann 11/18/08**U110 and Y510*IdeaPad 90W Slim AC/DC Combo Adapter 41N8460 *ann 12/18/07**U330, Y430, Y510, Y530, and Y730⁴⁵*Lenovo 90W AC Adapter 45J7717 *ann 08/12/08*⁴⁵ Only compatible with the integrated graphic models of Y730**Carrying Cases****S10**IdeaPad 10" Sleeve S110 (pink and gray) 45K2171 *ann 10/14/08**S10, U110 and U330*

Women's Executive Red Leather Tote 22P8858

Lenovo Women's Tote L34 (brown) 45J7728 *ann 06/03/08**S10, U110, U330, Y430, Y510, and Y530*IdeaPad Wenger® Backpack 45K1397 *ann 10/14/08*IdeaPad B450 Backpack (pink) 55Y2034 *ann 01/06/09*Lenovo Entry 15" Backpack B10 45J5468 *ann 07/15/08*Lenovo 15" Top Loader T35 (black) 45J7726 *ann 06/03/08*Lenovo Carrying Case - Backpack 40Y8603 *ann 05/01/07*Lenovo Carr Case - Performance Backpack 41U5254 *ann 05/01/07*

ThinkPad Sleek Backpack 41A4277

Lenovo Standard Case 45K1697 *ann 11/25/08*Lenovo Standard Backpack 45K1698 *ann 11/25/08***Monitors**ThinkVision® L174 17" Monitor 9227AE1 *ann 04/15/08*ThinkVision L1700p 17" Monitor 9417HE2 *ann 09/17/08*ThinkVision L1940p Wide 19" Monitor 4424HB6 *ann 09/17/08*ThinkVision L200p Wide 20.1" Monitor 4438HB6 *ann 04/15/08*ThinkVision L2240p Wide 22" Monitor 4422HB6 *ann 09/17/08*ThinkVision L2440p Wide 24" Monitor 4420HB2 *ann 09/17/08*ThinkVision L2440x Wide 24" Monitor 4421HB2 *ann 09/17/08***Monitor Accessories⁴⁶**ThinkVision USB Soundbar 40Y7616 *ann 08/23/05*ThinkVision Soundbar (L1900p, 24" Wide) 45K1263 *ann 09/16/08*Kensington Cable Lock from Lenovo 73P2582 *ann 12/29/03*Kensington Twin Head Cable Lock 45K1620 *ann 09/30/08*ThinkPad Convertible Monitor Stand 40Y7620 *ann 01/05/06*Radial Arm 19K4464 *ann 05/05/00*⁴⁶ Compatible on selected ThinkVision monitors.More information at www.lenovo.com/support/monitoraccessories**Consumer monitors**Lenovo L195 Wide 19" LCD Monitor 4418HC1 *ann 09/02/08*Lenovo L222 Wide 22" LCD Monitor 4432HF1 *ann 09/02/08*Other accessories at www.lenovo.com/accessoriesAccessories Guide pdf at www.lenovo.com/accessoriesguide

Availability: All offers subject to availability. Lenovo reserves the right to alter product offerings and specifications at any time, without notice. Lenovo is not responsible for photographic or typographic errors.

Warranty: For a copy of applicable product warranties, write to: Warranty Information, P.O. Box 12195, RTP, NC, 27709, Attn: Dept ZPYA/B676. Lenovo makes no representation or warranty regarding third party products or services.

Footnotes:

- ¹ Power management, including Intel® SpeedStep® Technology, reduces processor speed when in battery mode.
- ² **Weight** includes battery and standard optical drive; weight may vary due to vendor components, manufacturing process and options.
- ³ **Thinness** may vary at certain points on the system.
- ⁴ **Wireless capability:** Requires compatible wireless-enabled options sold separately.
- ⁵ **Post-warranty annual maintenance agreement:** Service begins at the end of the base warranty or the end of any other applied warranty and maintenance option, whichever occurs last. Service delivery is not available the same day the maintenance agreement is purchased. Maintenance agreements must be purchased and the registration successfully completed prior to the service being available.
- ⁶ **Public network download modem speeds** are limited to 53Kbps. Upload speeds are limited to 48Kbps for V.92 modems. Actual speeds depend on many factors and are often less than the maximum possible. V.92 functions and speeds require compatible phone line and server equipment. Check with your telephone and ISP service providers for availability.
- ⁷ **Maximum memory capacity** may require the replacement of standard component with largest supported component available. On ThinkPad systems, even though it is possible to physically install 4GB of memory, the actual amount of memory addressable by a 32-bit operating system will be limited to 3GB. This limitation does not exist with 64-bit operating systems Windows XP Professional 64-bit and Windows Vista 64-bit Editions.
- ⁸ **Hard drive:** GB = billion bytes, TB = trillion bytes. Accessible capacity is less; up to 4GB is service partition.
- ⁸ **Service upgrade options:** Service period begins with the equipment date of purchase. Service must be purchased during the original limited product warranty period. Service levels are response time objectives and are not guarantees.
- ¹⁰ **Battery:** These model numbers achieved the battery life based on MobileMark® 2007 during testing. Battery life (and recharge times) will vary based on many factors including screen brightness, applications, features, power management, battery conditioning, and other customer preferences.
- ¹¹ **Wireless:** Based on IEEE 802.11a, 802.11b, and 802.11g respectively. An adapter with 11a/b, 11b/g, or 11a/b/g can communicate on either/any of these listed formats respectively, the actual connection will be based on the access point to which it connects.
- ¹² **Limited warranty:** Support unrelated to a warranty issue may be subject to additional charges.
- ¹³ **Onsite Repair:** If a machine is listed as having "On-site", this means that on-site service is available for the replacement of parts for warranty repairs. Certain parts, referred to as Customer Replaceable Unit ("CRU") parts, are easy to install and require little or no tools or technical knowledge. Some examples of CRU parts are mice, keyboards, hard disk drives, speakers, and memory. If your problem can be resolved with a CRU, the Support Center will offer to ship the part to you for you to install.
- ¹⁴ **Included software** may differ from its retail version (if available), and may not include user manuals or all program functionality. Software license agreements may apply.
- ¹⁵ **Modem speeds:** Public network download speeds are limited to 53Kbps. Upload speeds are limited to 48Kbps for V.92 modems. Actual speeds depend on many factors and are often less than the maximum possible. V.92 functions and speeds require compatible phone line and server equipment. Check with your telephone and ISP service providers for availability.
- ¹⁶ **Response times may vary.** May exclude some holidays. Telephone support may be subject to additional charges.
- ¹⁷ **International Warranty Service** is available for most products in any country in which this product is sold and serviced. Service delivery methods and parts availability vary by country, may be different from that in the country of purchase, and are subject to change without notice. Fees and restrictions may apply in some countries.
- ¹⁸ **Telephone support** may be subject to additional charges, even during the limited warranty period. Response times may vary and may exclude some holidays.
- ¹⁹ **Depot repair service:** In the United States call 1-877-453-6686. The customer may be asked certain diagnostic questions before a courier is sent. Your purchase includes this depot repair service, available in the U.S. during the limited warranty period.
- ²⁰ **Operating System:** Level of support varies by operating system. Operating systems not preloaded on the system may not provide full feature functionality. Refer to lenovo.com/pc/support and enter your machine type and model number for more information.
- ²¹ **For combination drives,** maximum possible speeds only are given in the following order: CD write, CD rewrite, CD read, DVD read.
- ²² **Lenovo Care Services:** These services are available for machines normally used for business, professional, or trade purposes, rather than personal, family, or household purposes. Not all machine types and models are covered. Service period begins with the equipment date of purchase. Service must be purchased during the original limited product warranty period. Service levels are response time objectives and are not guarantees. If the machine problem turns out to be a Customer Replaceable Unit (CRU), a part can be express shipped to you for quick replacement. For notebooks requiring LCD or other component replacement, Lenovo may choose to perform service at the depot repair center. Calls must be received by 5 pm local time in order to qualify for Next Business Day service. P&L means parts and labor. P/U means pick-up. See terms and conditions for complete details and restrictions.

²⁵ **Wireless WAN Cards:** Wireless data service requires separate agreement with Verizon Wireless. Verizon Wireless, not Lenovo, is solely responsible for service. Monthly and airtime charges may apply. Service may not be available in all areas; purchaser is responsible for verifying with Verizon Wireless that service is available for the intended location before the purchase of the card. For complete details, including service plans, additional required hardware or software, and service coverage, visit www.verizonwireless.com.

²⁸ **The IEEE 802.11n specification (MIMO)** has not been finalized and is currently in draft release. The Lenovo 11a/b/g/n (11n) Wireless LAN Mini PCI Express Adapters are based on the Draft Release, Version 1.0, of the IEEE 802.11n specification. The maximum speed depends on the access point device and the number of integrated antenna used for connection. An adapter with 11a/b, 11a/b/g, or 11a/b/g/n can communicate on any of its supported formats.



This publication was developed for products and services offered in the United States. Lenovo may not offer the products, services or features discussed in this document in other countries. Lenovo may withdraw an offering at any time. Information is subject to change without notice. Consult your local representative for information on offerings available in your area.

Lenovo reserves the right to change specifications or other product information without notice. Lenovo is not responsible for photographic or typographical errors. **LENOVO PROVIDES THIS PUBLICATION "AS IS," WITHOUT WARRANTY OF ANY KIND, EITHER EXPRESS OR IMPLIED, INCLUDING THE IMPLIED WARRANTIES OF MERCHANTABILITY OR FITNESS FOR A PARTICULAR PURPOSE.** Some jurisdictions do not allow disclaimer of express or implied warranties in certain transactions, therefore this disclaimer may not apply to you.

Trademarks: Lenovo, the Lenovo logo, New World. New Thinking., Access Connections, Rescue and Recovery, ThinkVantage, and ThinkVision are trademarks of Lenovo. Microsoft, Windows, and Vista are registered trademarks of Microsoft Corporation. Intel, the Intel logo, Intel Inside logo, Intel Atom, Intel Core and Core Inside are trademarks of Intel Corporation in the US and other countries. Other company, product, or service names may be trademarks or service marks of others.

ENERGY STAR: As an ENERGY STAR Partner, Lenovo has determined that this product meets the ENERGY STAR guidelines for energy efficiency.

Visit www.lenovo.com/safecomputing periodically for the latest information on safe and effective computing.

Visit www.lenovo.com/psref for the latest version of Personal Systems Reference.

© Lenovo, 2009.
All rights reserved.

Lenovo
1009 Think Place
Morrisville, NC 27560
U.S.A.

January 2009
ipbook.pdf

Personal Systems Reference Lenovo IdeaCentre Desktops

January 2009 - Version 350



Visit www.lenovo.com/psref for the latest version

Part number	Slot x bay	Processor	GHz	L2 cache	Cores	Memory ³	Media reader	SATA disk	SATA optical	Graphics	Modem	Monitor	Camera	Vista preload	Avail date
57-078915	4x5	Celeron E1200	1.60	512KB	2	2GB	16-in-1	320GB ²	DVD±RW	GMA 3100			Camera	Home Prem	May 08
57-078894	4x5	Pentium E2140	1.60	1MB	2	4GB	16-in-1	500GB	DVD±RW	GMA 3100			Camera	Home Prem	May 08
57-076245	4x5	Pentium E2180	2.00	1MB	2	1GB	16-in-1	320GB	DVD±RW	GMA 3100	Mod			Home Basic	May 08
57-076162	4x5	Pentium E2180	2.00	1MB	2	2GB	16-in-1	320GB	DVD±RW	GMA 3100	Mod		Camera	Home Prem	May 08
57-076161	4x5	Pentium E2180	2.00	1MB	2	3GB	16-in-1	500GB	DVD±RW	GMA 3100	Mod			Home Prem	May 08
57-076522	4x5	Pentium E2180	2.00	1MB	2	3GB	16-in-1	500GB	DVD±RW	GMA 3100	Mod	L222	Camera	Home Prem	May 08

- **Antibacterial keyboard uses special material on the surface of the keys to restrain bacterial growth**
- **Lenovo Rescue System provides OneKey recovery and OneKey Antivirus without booting into Windows**
- **(Select models) Healthcare eyesight protection software detect distance between user and monitor and adjusts monitor brightness based on environment**
- **(Select models) Lenovo Bright Eye camera and VeriFace face recognition software help control access to your computer by recognizing your face**

Processor	Intel® Celeron® Dual-Core Processor E1200 with dual-core, Intel 64 Technology, Execute Disable Bit, EIST, 800MHz system bus, and 512KB L2 cache or Intel Pentium® Dual-Core Processor E2140 or E2180 with dual-core, Intel 64 Technology, Execute Disable Bit, EIST, 800MHz system bus, and 1MB L2 cache	Tower
Implementation	Processor in FC-LGA6 package in LGA775 socket	<ul style="list-style-type: none"> • Black and silver bezel • 7.1" W X 17.0" D X 15.0" H • 180mm W X 432mm D X 380mm H • 21.5 lb (9.75 kg) • Toolless cover removal • Toolless disk, optical drive removal • Toolless adapter retention
Memory	1GB, 2GB, 3GB, or 4GB std, 4GB max⁵, PC2-5300 667MHz DDR2 , non-parity, dual-channel capable, two 240-pin DIMM sockets <i>Italics:</i> standard memory in both sockets; no sockets available; <i>Non-italics:</i> standard memory in one socket; 1 socket available	Bay ① 5.25", 1.6" high, access, standard optical Bay ② 5.25", 1.6" high, access, open Bay ③ 3.0", 1" high, access, 16-in-1 media reader Bay ④ 3.5", 1" high, no access, standard disk Bay ⑤ 3.5", 1" high, no access, optional disk
Graphics	Intel Graphics Media Accelerator 3100 (GMA 3100) , integrated graphics in G31, uses main memory, one 15-pin analog D-sub connector	Slot 1: half-length, full-height, PCI Express x1 Ver 1.1 Slot 2: half-length, full-height, PCI Express x16 Ver 1.1 Slot 3: half-length, full-height, 32-bit PCI Ver 2.3 * Slot 4: half-length, full-height, 32-bit PCI Ver 2.3 * modem in slot in some models
SATA disk	320GB or 500GB , SATA 3.0Gb/s, 7200 rpm	
SATA controller	Serial ATA, SATA 3.0Gb/s, integrated in ICH7DH	
SATA DVD±RW	Multi-Burner DL DVD±RW SATA 1.5Gb/s Drive	
SATA cables	Two SATA cables (each 1-drop to device), four SATA connectors	
EIDE controller	One	
EIDE cables	None	
Diskette drive	None	
Media reader	16-in-1 media reader, internal USB 2.0	
Chipset	Intel G31 Express Chipset ; I/O Controller Hub 7 Digital Home (ICH7DH) for SATA 3.0Gb/s, PCI Express® x1, PCI 2.3, USB, LPC bus / Winbond® W83627DHG Super I/O for serial, parallel, keyboard, mouse functions	
Front ports	Two USB 2.0, microphone (stereo, 3.5mm), headphone (stereo, 3.5mm)	
Rear ports	Four USB 2.0, one serial (9-pin), parallel (25-pin), keyboard (PS/2), mouse (PS/2), ethernet (RJ-45), monitor (DB-15)	
Rear audio ports	Line-in (stereo, 3.5mm), line-out (stereo, 3.5mm), microphone-in (stereo, 3.5mm)	
Audio	High Definition (HD) audio, ALC662 codec	
External speakers	None	
Internal speaker	None	
Ethernet	10/100 ethernet on planar, Intel 82562GZ (PHY/MAC)	
Modem	<i>Some:</i> 56K ¹⁰ V.92 data/fax soft modem, PCI adapter	
Security chip	None	
TV tuner	None	
Camera	<i>Some:</i> Lenovo Bright Eye camera, 0.3-megapixel, fixed focus	
Keyboard	104-key antibacterial keyboard (PS/2 connector)	
Mouse	Optical Wheel Mouse (USB connector), 400 dpi	
Power supply	280 watts, universal, manual switch	
Preloaded operating system²⁰	<ul style="list-style-type: none"> - <i>Some:</i> Microsoft® Windows® Vista® Home Basic Edition (32-bit) - <i>Some:</i> Microsoft Windows Vista Home Premium Edition (32-bit) ◇ 57-076245: Vista Basic logo ◇ <i>Others:</i> Vista Premium logo 	
Preloaded applications⁵	<ul style="list-style-type: none"> • Lenovo™ OneKey Recovery • Lenovo Healthcare Software • Lenovo Media Studio • Driver and Application Installation • Trend Micro™ PC-cillin™ Internet Security 2007 • EarthLink® • Windows Live™ Toolbar • Microsoft Office 2007 Trial (60-day) • VeriFace™ Facial Recognition™ • Corel® WinDVD® (DVD±RW) • CyberLink Power2Go (DVD±RW) 	
		Available at these retailers <ul style="list-style-type: none"> • B&H™ • J&R™ • Newegg® • TigerDirect • ASI Computer Systems
		Limited Warranty¹ <ul style="list-style-type: none"> ⇨ 1-year parts and labor ⇨ Customer Replaceable Unit (CRU) parts only (with limited onsite service for selected parts³, 8 am - 5 pm, Mon - Fri coverage excluding holidays, next business day response time) ⇨ Service upgrade options (in eligible locations):⁹ <ul style="list-style-type: none"> • 3-year Lenovo Onsite Repair 9x5 Next Business Day (43R8882) ⇨ 24x7¹⁴ toll-free support for warranty issues during the warranty period¹ via 877-453-6686

See footnotes for important warranty information
US models announced May 12, 2008

Part number	Slot x bay	Processor	L2 cache	GHz	Cores	Memory ⁸	Media reader	SATA disk	SATA optical	Graphics	Modem	Monitor	Camera	Vista preload	Avail date
57-076523	4x5	Core 2 Duo E4600	2.40	2MB	2	3GB	16-in-1	500GB ²	DVD±RW	GMA 3100	Mod	None	None	Home Prem	May 08
57-082791	4x5	Core 2 Duo E7200	2.53	3MB	2	3GB	16-in-1	500GB	DVD±RW	GMA 3100		None	Cam	Home Prem	Aug 08
57-076158	4x5	Core 2 Quad Q6600	2.40	8MB	4	3GB	16-in-1	500GB	DVD±RW	GMA 3100	Mod	None	None	Home Prem	May 08
57-076244	4x5	Core 2 Quad Q6600	2.40	8MB	4	3GB	16-in-1	500GB	Blu-ray	HD 2600 PRO	Mod	None	None	Home Prem	May 08
57-082788	4x5	Core 2 Quad Q6600	2.40	8MB	4	4GB	16-in-1	500GB	DVD±RW	9300 GE	Mod	None	Cam	Home Prem	Aug 08

- **Antibacterial keyboard uses special material on the surface of the keys to restrain bacterial growth**
- **Lenovo Rescue System provides OneKey recovery and OneKey Antivirus without booting into Windows**
- **(Select models) Healthcare eyesight protection software detect distance between user and monitor and adjusts monitor brightness based on environment**
- **(Select models) Lenovo Bright Eye camera and VeriFace face recognition software help control access to your computer by recognizing your face**

Processor	<p>Intel® Core™ 2 Duo Processor E4600 with dual-core, Intel 64 Technology, Execute Disable Bit, EIST, 800MHz system bus, and 2MB L2 cache or</p> <p>Intel Core 2 Duo Processor E7200 with dual-core, Intel 64 Technology, Execute Disable Bit, EIST, 1066MHz system bus, and 3MB L2 cache or</p> <p>Intel Core 2 Quad Processor Q6600 with quad-core (dual-core on dual-die), Intel 64 Technology, Virtualization Technology, Execute Disable Bit, EIST, 1066MHz system bus, and 8MB L2 cache</p> <p>Processor in FC-LGA6 package in LGA775 socket</p>	<p>Tower</p> <ul style="list-style-type: none"> • Black and silver bezel • 7.1" W X 17.0" D X 15.0" H • 180mm W X 432mm D X 380mm H • 21.5 lb (9.75 kg) • Toolless cover removal • Toolless disk, optical drive removal • Toolless adapter retention
Implementation		<p>Bay ① 5.25", 1.6" high, access, standard optical</p> <p>Bay ② 5.25", 1.6" high, access, open</p> <p>Bay ③ 3.0", 1" high, access, 16-in-1 media reader</p> <p>Bay ④ 3.5", 1" high, no access, standard disk</p> <p>Bay ⑤ 3.5", 1" high, no access, optional disk</p>
Memory	<p>3GB or 4GB std, 4GB max⁸, PC2-5300 667MHz DDR2, non-parity, dual-channel capable, two 240-pin DIMM sockets</p> <p><i>Italics:</i> standard memory in both sockets; no sockets available</p>	
Graphics	<p><i>Some:</i> Intel Graphics Media Accelerator 3100 (GMA 3100), integrated graphics in G31, uses main memory, one 15-pin analog D-sub connector</p> <p><i>Some:</i> ATI™ Radeon™ HD 2600 PRO, PCI Express x16, 256MB memory, DirectX® 10, ATI Avivo™, one D-sub connector and one DVI-D connector, HDCP-compliant</p> <p><i>Some:</i> NVIDIA® GeForce® 9300 GE, PCI Express x16, 256MB memory, DirectX® 10, TurboCache, PureVideo™ HD technology, S-video out, VGA connector, DVI-I connector, HDCP-compliant</p>	<p>Slot 1: half-length, full-height, PCI Express x1 Ver 1.1</p> <p>Slot 2: half-length, full-height, PCI Express x16 Ver 1.1**</p> <p>Slot 3: half-length, full-height, 32-bit PCI Ver 2.3 *</p> <p>Slot 4: half-length, full-height, 32-bit PCI Ver 2.3</p> <p>* modem in slot</p> <p>** used in some models</p>
SATA disk	<p>500GB, SATA 3.0Gb/s, 7200 rpm</p> <p>Serial ATA, SATA 3.0Gb/s, integrated in ICH7DH</p>	
SATA controller	<p><i>Some:</i> Multi-Burner DL DVD±RW SATA 1.5Gb/s Drive</p>	
SATA DVD±RW	<p><i>Some:</i> Blu-ray Disc reader (no Blu-ray media burning), supports HD-DVD playback, DVD and CD recordable</p>	
SATA Blu-ray™		
SATA cables	Two SATA cables (each 1-drop to device), four SATA connectors	
EIDE controller	One	
EIDE cables	None	
Diskette drive	None	
Media reader	16-in-1 media reader, internal USB 2.0	
Chipset	<p>Intel G31 Express Chipset; I/O Controller Hub 7 Digital Home (ICH7DH) for SATA 3Gb/s, PCI Express® x1, PCI 2.3, USB, LPC bus / Winbond® W83627DHG Super I/O for serial, parallel, keyboard, mouse functions</p>	
Front ports	Two USB 2.0, microphone (stereo, 3.5mm), headphone (stereo, 3.5mm)	
Rear ports	Four USB 2.0, one serial (9-pin), parallel (25-pin), keyboard (PS/2), mouse (PS/2), ethernet (RJ-45), monitor (DB-15, DVI-D in some models)	
Rear audio ports	Line-in (stereo, 3.5mm), line-out (stereo, 3.5mm), microphone-in (stereo, 3.5mm)	
Audio	High Definition (HD) audio, ALC662 codec	
External speakers	None	
Internal speaker	None	
Ethernet	10/100 ethernet on planar, Intel 82562GZ (PHY/MAC)	
Modem	<i>Some:</i> 56K ¹⁰ V.92 data/fax soft modem, PCI adapter	
Security chip	None	
TV tuner	None	
Camera	<i>Some:</i> Lenovo Bright Eye camera, 0.3-megapixel, fixed focus	
Keyboard	104-key anti-bacterial keyboard (PS/2 connector)	
Mouse	Optical Wheel Mouse (USB connector), 400 dpi	
Power supply	280 watts, universal, manual switch	
Preloaded operating system²⁰	<p>- Microsoft® Windows® Vista® Home Premium Edition (32-bit)</p> <p>↳ Vista Premium logo</p>	<p>Limited Warranty¹</p> <ul style="list-style-type: none"> ↳ 1-year parts and labor ↳ Customer Replaceable Unit (CRU) parts only (with limited onsite service for selected parts³, 8 am - 5 pm, Mon - Fri coverage excluding holidays, next business day response time) ↳ Service upgrade options (in eligible locations):⁹ <ul style="list-style-type: none"> • 3-year Lenovo Onsite Repair 9x5 Next Business Day (43R8882) ↳ 24x7¹⁴ toll-free support for warranty issues during the warranty period¹ via 877-453-6686
Preloaded applications⁵	<ul style="list-style-type: none"> • Lenovo™ OneKey Recovery • Lenovo Healthcare Software • Lenovo Media Studio • Driver and Application Installation • Trend Micro™ PC-cillin™ Internet Security 2007 • EarthLink® • Windows Live™ Toolbar • Microsoft Office 2007 Trial (60-day) • VeriFace™ Facial Recognition™ • Corel® WinDVD® (DVD±RW, Blu-ray) • CyberLink Power2Go (DVD±RW, Blu-ray) 	

See footnotes for important warranty information

ES® US models announced July 15, 2008; previous models on May 12, 2008

Type-model	Slot x bay	Processor	GHz	L2 cache	Cores	Memory ³	Media reader	SATA disk	SATA optical	Graphics	Modem	Monitor	Camera	Vista preload	Avail date
5313-3AU	4x5	Celeron E1200	1.60	512KB	2	1GB		160GB ²	DVD	GMA 3100		None		Home Basic	Jul 08
5313-3BU	4x5	Celeron E1200	1.60	512KB	2	1GB	16-in-1	250GB	DVD±RW	GMA 3100	Mod	None		Home Prem	Jul 08
5313-4AU	4x5	Pentium E2180	2.00	1MB	2	2GB	16-in-1	320GB	DVD±RW	GMA 3100	Mod	None	Camera	Home Prem	Jul 08
5313-4BU	4x5	Pentium E2180	2.00	1MB	2	3GB	16-in-1	500GB	DVD±RW	GMA 3100		None	Camera	Home Prem	Jul 08
5313-4DU	4x5	Pentium E2200	2.20	1MB	2	2GB		250GB	DVD±RW	GMA 3100		None		Home Prem	Oct 08
5313-4EU	4x5	Pentium E2200	2.20	1MB	2	3GB		320GB	DVD±RW	GMA 3100		None		Home Prem	Oct 08
5313-4CU	4x5	Pentium E2200	2.20	1MB	2	4GB	16-in-1	500GB	DVD±RW	GMA 3100		None	Camera	Home Prem	Jul 08
5313-5CU	4x5	Pentium E5200	2.50	2MB	2	4GB	16-in-1	640GB	DVD±RW	GMA 3100		None		Home Prem	Nov 08

- **Antibacterial keyboard uses special material on the surface of the keys to restrain bacterial growth**
- **Lenovo Rescue System provides OneKey recovery and OneKey Antivirus without booting into Windows**
- **(Select models) Healthcare eyesight protection software detect distance between user and monitor and adjusts monitor brightness based on environment**
- **(Select models) Lenovo Bright Eye camera and VeriFace face recognition software help control access to your computer by recognizing your face**

Processor	Intel® Celeron® Dual-Core Processor E1200 with dual-core, Intel 64 Technology, Execute Disable Bit, EIST, 800MHz system bus, and 512KB L2 cache or Intel Pentium® Dual-Core Processor E2180, E2200, or E5200 with dual-core, Intel 64 Technology, Execute Disable Bit, EIST, 800MHz system bus; <i>E2180/E2200:</i> 1MB L2 cache; <i>E5200:</i> 2MB L2 cache	Tower
Implementation	Processor in FC-LGA6 package in LGA775 socket	<ul style="list-style-type: none"> • Black and silver bezel • 7.1" W X 17.0" D X 15.0" H • 180mm W X 432mm D X 380mm H • 21.5 lb (9.75 kg) • Toolless cover removal • Toolless disk, optical drive removal • Toolless adapter retention
Memory	1GB, 2GB, 3GB, or 4GB std, 4GB max ⁸ , PC2-5300 667MHz DDR2 , non-parity, dual-channel capable, two 240-pin DIMM sockets <i>Italics:</i> standard memory in both sockets; no sockets available; <i>Non-italics:</i> standard memory in one socket; 1 socket available	Bay ① 5.25", 1.6" high, access, standard optical Bay ② 5.25", 1.6" high, access, open Bay ③ 3.0", 1" high, access, 16-in-1 media reader Bay ④ 3.5", 1" high, no access, standard disk Bay ⑤ 3.5", 1" high, no access, optional disk
Graphics	Intel Graphics Media Accelerator 3100 (GMA 3100) , integrated graphics in G31, uses main memory, one 15-pin analog D-sub connector	Slot 1: half-length, full-height, PCI Express x1 Ver 1.1 Slot 2: half-length, full-height, PCI Express x16 Ver 1.1 Slot 3: half-length, full-height, 32-bit PCI Ver 2.3 * Slot 4: half-length, full-height, 32-bit PCI Ver 2.3
SATA disk	160GB, 250GB, 320GB, 500GB, or 640GB SATA 3Gb/s, 7200 rpm	
SATA controller	Serial ATA, SATA 3.0Gb/s, integrated in ICH7DH	
SATA DVD	<i>Some:</i> DVD-ROM DL SATA 1.5Gb/s 16X-48X Max ⁴	
SATA DVD±RW	<i>Some:</i> Multi-Burner DL DVD±RW SATA 1.5Gb/s Drive	
SATA cables	Two SATA cables (each 1-drop to device), four SATA connectors	
EIDE controller	One	
EIDE cables	None	
Diskette drive	None	
Media reader	<i>Some:</i> 16-in-1 media reader, internal USB 2.0	
Chipset	Intel G31 Express Chipset; I/O Controller Hub 7 Digital Home (ICH7DH) for SATA 3Gb/s, PCI Express® x1, PCI 2.3, USB, LPC bus / Winbond® W83627DHG Super I/O for serial, parallel, keyboard, mouse functions	
Front ports	Two USB 2.0, microphone (stereo, 3.5mm), headphone (stereo, 3.5mm)	
Rear ports	Four USB 2.0, one serial (9-pin), parallel (25-pin), keyboard (PS/2), mouse (PS/2), ethernet (RJ-45), monitor (DB-15)	
Rear audio ports	Line-in (stereo, 3.5mm), line-out (stereo, 3.5mm), microphone-in (stereo, 3.5mm)	
Audio	High Definition (HD) audio, ALC662 codec	
External speakers	None	
Internal speaker	None	
Ethernet	10/100 ethernet on planar, Intel 82562GZ (PHY/MAC)	
Modem	<i>Some:</i> 56K ¹⁰ V.92 data/fax soft modem, PCI adapter	
Security chip	None	
TV tuner	None	
Camera	<i>Some:</i> Lenovo Bright Eye camera, 0.3-megapixel, fixed focus	
Keyboard	104-key antibacterial keyboard (PS/2 connector)	
Mouse	Optical Wheel Mouse (USB connector), 400 dpi	
Power supply	280 watts, universal, manual switch	
Preloaded operating system²⁰	<ul style="list-style-type: none"> - <i>Some:</i> Microsoft® Windows® Vista® Home Basic Edition (32-bit) - <i>Some:</i> Microsoft Windows Vista Home Premium Edition (32-bit) ◇ 5313-3AU/3BU: Vista Basic logo ◇ <i>Others:</i> Vista Premium logo 	<ul style="list-style-type: none"> • Preloaded applications⁵ • Lenovo™ OneKey Recovery • Lenovo Healthcare Software • Lenovo Media Studio • Driver and Application Installation • Trend Micro™ PC-cillin™ Internet Security 2007 • EarthLink® • Windows Live™ Toolbar • Microsoft Office 2007 Trial (60-day) • VeriFace™ Facial Recognition™ • Corel® WinDVD® (DVD, DVD±RW) • CyberLink Power2Go (DVD, DVD±RW)
		Available at these retailers <ul style="list-style-type: none"> • lenovo.com • Fry's
		Limited Warranty¹ <ul style="list-style-type: none"> ⇨ 1-year parts and labor ⇨ Customer Replaceable Unit (CRU) parts only (with limited onsite service for selected parts³, 8 am - 5 pm, Mon - Fri coverage excluding holidays, next business day response time) ⇨ Service upgrade options (in eligible locations):⁹ <ul style="list-style-type: none"> • 3-year Lenovo Onsite Repair 9x5 Next Business Day (43R8882) ⇨ 24x7¹⁴ toll-free support for warranty issues during the warranty period¹ via 877-453-6686

See footnotes for important warranty information

ES® US models announced November 12, 2008; previous models on July 15 or October 22, 2008

	Slot x Type-model bay	Processor	L2 GHz cache	Cores	Memory ⁸	Media reader	SATA disk	SATA optical	Graphics	Modem	Monitor	Cam- era	Vista preload	Avail date
ES*	5313-1FU 4x5	Core 2 Duo E7200	2.53 3MB	2	4GB	16-in-1	640GB ²	DVD±RW	GMA 3100	None	None	None	Home Prem	Oct 08
	5313-2BU 4x5	Core 2 Quad Q6600	2.40 8MB	4	4GB	16-in-1	500GB	DVD±RW	GMA 3100	None	None	Cam	Home Prem	Jul 08
	5313-2CU 4x5	Core 2 Quad Q6600	2.40 8MB	4	4GB	16-in-1	500GB	Blu-ray	9300 GE	None	None	Cam	Home Prem	Jul 08
ES*	5313-2FU 4x5	Core 2 Quad Q6600	2.40 8MB	4	4GB	16-in-1	1TB	Blu-ray	9300 GE	None	None	None	Home Prem	Oct 08

- **Antibacterial keyboard uses special material on the surface of the keys to restrain bacterial growth**
- **Lenovo Rescue System provides OneKey recovery and OneKey Antivirus without booting into Windows**
- **(Select models) Healthcare eyesight protection software detect distance between user and monitor and adjusts monitor brightness based on environment**
- **(Select models) Lenovo Bright Eye camera and VeriFace face recognition software help control access to your computer by recognizing your face**

Processor	Intel® Core 2 Duo™ Processor E7200 with dual-core , Intel 64 Technology, Execute Disable Bit, EIST, 1066MHz system bus, and 3MB L2 cache or Intel Core 2 Quad Processor Q6600 with quad-core (dual-core on dual-die), Intel 64 Technology, Virtualization Technology, Execute Disable Bit, EIST, 1066MHz system bus, and 8MB L2 cache	Tower <ul style="list-style-type: none"> • Black and silver bezel • 7.1" W X 17.0" D X 15.0" H • 180mm W X 432mm D X 380mm H • 21.5 lb (9.75 kg) • Toolless cover removal • Toolless disk, optical drive removal • Toolless adapter retention
Implementation	Processor in FC-LGA6 package in LGA775 socket	
Memory	4GB std , 4GB max ⁹ , PC2-5300 667MHz DDR2 , non-parity, dual-channel capable, two 240-pin DIMM sockets <i>Italics:</i> standard memory in both sockets; no sockets available	Bay ① 5.25", 1.6" high, access, standard optical Bay ② 5.25", 1.6" high, access, open Bay ③ 3.0", 1" high, access, 16-in-1 media reader Bay ④ 3.5", 1" high, no access, standard disk Bay ⑤ 3.5", 1" high, no access, optional disk
Graphics	<i>Some:</i> Intel Graphics Media Accelerator 3100 (GMA 3100) , integrated graphics in G31, uses main memory, one 15-pin analog D-sub connector <i>Some:</i> NVIDIA® GeForce® 9300 GE , PCI Express® x16, 256MB memory, DirectX® 10, TurboCache, PureVideo™ HD technology, S-video out, VGA connector, DVI-I connector, HDCP-compliant	Slot 1: half-length, full-height, PCI Express x1 Ver 1.1 Slot 2: half-length, full-height, PCI Express x16 Ver 1.1** Slot 3: half-length, full-height, 32-bit PCI Ver 2.3 Slot 4: half-length, full-height, 32-bit PCI Ver 2.3
SATA disk	500GB, 640GB, or 1TB , SATA 3.0Gb/s, 7200 rpm	
SATA controller	Serial ATA, SATA 3.0Gb/s, integrated in ICH7DH	
SATA DVD±RW	<i>Some:</i> Multi-Burner DL DVD±RW SATA 1.5Gb/s Drive	
SATA Blu-ray™	<i>Some:</i> Blu-ray Disc reader (no Blu-ray media burning), BD-ROM, supports HD-DVD playback, DVD and CD recordable	
SATA cables	Two SATA cables (each 1-drop to device), four SATA connectors	
EIDE controller	One	
EIDE cables	None	
Diskette drive	None	
Media reader	16-in-1 media reader, internal USB 2.0	
Chipset	Intel G31 Express Chipset ; I/O Controller Hub 7 Digital Home (ICH7DH) for SATA 3Gb/s, PCI Express® x1, PCI 2.3, USB, LPC bus / Winbond® W83627DHG Super I/O for serial, parallel, keyboard, mouse functions	
Front ports	Two USB 2.0, microphone (stereo, 3.5mm), headphone (stereo, 3.5mm)	
Rear ports	Four USB 2.0, one serial (9-pin), parallel (25-pin), keyboard (PS/2), mouse (PS/2), ethernet (RJ-45), monitor (DB-15, DVI-I in some models)	
Rear audio ports	Line-in (stereo, 3.5mm), line-out (stereo, 3.5mm), microphone-in (stereo, 3.5mm)	
Audio	High Definition (HD) audio, ALC662 codec	
External speakers	None	
Internal speaker	None	
Ethernet	10/100 ethernet on planar, Intel 82562GZ (PHY/MAC)	
Modem	None	
Security chip	None	
TV tuner	None	
Camera	<i>Some:</i> Lenovo Bright Eye camera, 0.3-megapixel, fixed focus	
Keyboard	104-key anti-bacterial keyboard (PS/2 connector)	Available at these retailers <ul style="list-style-type: none"> • lenovo.com • Fry's
Mouse	Optical Wheel Mouse (USB connector), 400 dpi	
Power supply	280 watts, universal, manual switch	
Preloaded operating system²⁰ - Microsoft® Windows® Vista® Home Premium Edition (32-bit) ♦ Vista Premium logo		Limited Warranty¹ ⇨ 1-year parts and labor ⇨ Customer Replaceable Unit (CRU) parts only (with limited onsite service for selected parts³, 8 am - 5 pm, Mon - Fri coverage excluding holidays, next business day response time) ⇨ Service upgrade options (in eligible locations):⁹ • 3-year Lenovo Onsite Repair 9x5 Next Business Day (43R8882) ⇨ 24x7¹⁴ toll-free support for warranty issues during the warranty period¹ via 877-453-6686
Preloaded applications⁵ <ul style="list-style-type: none"> • Lenovo™ OneKey Recovery • Lenovo Healthcare Software • Lenovo Media Studio • Driver and Application Installation • Trend Micro™ PC-cillin™ Internet Security 2007 • EarthLink® • Windows Live™ Toolbar • Microsoft Office 2007 Trial (60-day) • VeriFace™ Facial Recognition™ • Corel® WinDVD® (DVD±RW, Blu-ray) • CyberLink Power2Go (DVD±RW, Blu-ray) 		

See footnotes for important warranty information

ES* US models announced October 22, 2008; previous models on July 15, 2008

Type-model	Slot x bay	Processor	GHz	L2 cache	Cores	Memory ⁸	Media reader	SATA disk	SATA optical	Graphics	Monitor	Camera	802.11 wireless	Vista preload	Vista logo	Avail date
5358-4AU	4x5	E2220	2.40	1MB	2	2GB	16-in-1	250GB ²	Blu-ray	GMA 4500	None	None		Prem 64	Basic	Jan 09
5358-4BU	4x5	E2220	2.40	1MB	2	4GB	16-in-1	640GB	Blu-ray	GMA 4500	None	None		Prem 64	Basic	Jan 09
5358-1FU	4x5	E5200	2.50	2MB	2	4GB	16-in-1	500GB	DVD±RW	GMA 4500	None	None		Prem 64	Basic	Jan 09
5358-1BU	4x5	E5200	2.50	2MB	2	4GB	16-in-1	640GB	DVD±RW	9300 GE	None	None	11b/g	Prem 64	Prem	Jan 09
5358-2CU	4x5	Q8200	2.33	4MB	4	4GB	16-in-1	640GB	DVD±RW	9300 GE	None	None		Prem 64	Prem	Jan 09
5358-2DU	4x5	Q8200	2.33	4MB	4	4GB	16-in-1	1TB	Blu-ray	9300 GE	None	None	11b/g	Prem 64	Prem	Jan 09

- **Antibacterial keyboard uses special material on the surface of the keys to restrain bacterial growth**
- **Lenovo Rescue System provides OneKey recovery and OneKey Antivirus without booting into Windows**

Processor	Intel® Pentium® Dual-Core Processor E2220 or E5200 with dual-core, Intel 64 Technology, Execute Disable Bit, EIST, 800MHz system bus; <i>E2220:</i> 1MB L2 cache; <i>E5200:</i> 2MB L2 cache or Intel Core™ 2 Quad Processor Q8200 with quad-core (dual-core on dual-die), Intel 64 Technology, Execute Disable Bit, EIST, 1333MHz system bus, and 4MB L2 cache Processor in FC-LGA6 package in LGA775 socket	Tower <ul style="list-style-type: none"> • Black bezel • 7.1" W X 17.0" D X 15.0" H • 180mm W X 432mm D X 380mm H • 21.5 lb (9.75 kg) • Toolless cover removal • Toolless disk, optical drive removal • Toolless adapter retention
Implementation		
Memory	2GB or 4GB std, 4GB max⁸, PC3-8500 1066MHz DDR3 , non-parity, dual-channel capable, two 240-pin DIMM sockets <i>Italics:</i> standard memory in both sockets; no sockets available; <i>Non-italics:</i> standard memory in one socket; 1 socket available	Bay ① 5.25", 1.6" high, access, standard optical Bay ② 5.25", 1.6" high, access, open Bay ③ 3.0", 1" high, access, 16-in-1 media reader Bay ④ 3.5", 1" high, no access, standard disk Bay ⑤ 3.5", 1" high, no access, optional disk
Graphics	<i>Some:</i> Intel Graphics Media Accelerator 4500 (GMA 4500) , integrated graphics in G43, uses main memory, DirectX® 10, one 15-pin analog VGA DB-15 connector <i>Some:</i> NVIDIA® GeForce® 9300 GE , PCI Express® x16, 512MB memory, DirectX® 10, TurboCache, PureVideo™ HD technology, S-video out for TV-out, VGA DB-15 connector, DVI-I connector, HDCP-compliant	Slot 1: half-length, full-height, PCI Express x16 Ver 2.0 * Slot 2: half-length, full-height, PCI Express x1 Ver 2.0 ** Slot 3: half-length, full-height, 32-bit PCI Ver 2.3 Slot 4: half-length, full-height, 32-bit PCI Ver 2.3 * Wireless adapter in slot in some models ** used in some models
SATA disk	250GB, 500GB, 640GB or 1TB SATA 3Gb/s, 7200 rpm	
SATA controller	Serial ATA, SATA 3.0Gb/s, integrated in ICH10	
SATA DVD±RW	<i>Some:</i> Multi-Burner DL DVD±RW SATA 1.5Gb/s Drive	
SATA Blu-ray™	<i>Some:</i> Blu-ray Disc reader (no Blu-ray media burning), BD-ROM, DVD and CD recordable	
SATA cables	Two SATA cables (each 1-drop to device), four SATA connectors	
EIDE controller	None	
Diskette drive	None	
Media reader	16-in-1 media reader, internal USB 2.0	
Chipset	Intel G43 Express Chipset (PCI Express® 2.0 x16), I/O Controller Hub 10 [ICH10] (SATA 3.0Gb/s, PCI Express x1, ethernet MAC, PCI 2.3, USB, LPC bus), SMSC® SCH5147-NW Super I/O	
Front ports	Two USB 2.0, microphone (stereo, 3.5mm), headphone (stereo, 3.5mm)	
Rear ports	Six USB 2.0, one serial (9-pin), keyboard (PS/2), mouse (PS/2), ethernet (RJ-45), <i>1BU/2CU/2DU:</i> monitor (VGA DB-15, DVI-I), S-Video out; <i>Others:</i> monitor (VGA DB-15)	
Rear audio ports	Line-in (stereo, 3.5mm), line-out (stereo, 3.5mm), microphone-in (stereo, 3.5mm)	
Audio	High Definition (HD) audio, ALC662 codec	
External speakers	None	
Internal speaker	None	
Wireless	<i>Some:</i> 11b/g wireless ⁴ , Broadcom BCM4312, PCIe x1 adapter	
Ethernet	10/100 ethernet on planar, Realtek® RTL8102E	
Modem	None	
Security chip	None	
TV tuner	None	
Camera	None	
Keyboard	104-key antibacterial keyboard (PS/2 connector)	
Mouse	Optical Wheel Mouse (USB connector), 400 dpi	
Power supply	280 watts, universal, manual switch	
Preloaded operating system²⁰ - Microsoft® Windows® Vista® Home Premium Edition (64-bit)	Preloaded applications⁵ <ul style="list-style-type: none"> • Lenovo® OneKey Recovery • Driver and Application Installation • Trend Micro™ PC-cillin™ Internet Security 2008 • Windows Live™ Toolbar • Microsoft Office 2007 Trial (60-day) • Corel® WinDVD® (DVD±RW, Blu-ray) • CyberLink Power2Go (DVD±RW, Blu-ray) 	Available at these retailers <ul style="list-style-type: none"> • lenovo.com • Fry's • Circuit City®
		Limited Warranty¹ <ul style="list-style-type: none"> ↪ 1-year parts and labor ↪ Customer Replaceable Unit (CRU) parts only (with limited onsite service for selected parts³, 8 am - 5 pm, Mon - Fri coverage excluding holidays, next business day response time) ↪ Service upgrade options (in eligible locations):⁹ <ul style="list-style-type: none"> • 3-year Lenovo Onsite Repair 9x5 Next Business Day (43R8882) ↪ 24x7¹⁴ toll-free support for warranty issues during the warranty period¹ via 877-453-6686



See footnotes for important warranty information
US models announced January 13, 2009

Type-model	Slot x bay	Processor	GHz	L2 cache	Cores	Memory ⁸	DIMM capacity	Media reader	SATA disk	SATA optical	Graphics	TV tuner	Remote control	802.11 wireless	Vista preload	Avail date
5359-1BU	4x5	E2220	2.40	1MB	2	5GB	(2, 2, 1)	16-in-1	500GB ²	DVD±RW	GMA 3100				Prem 64	Jan 09
5359-2EU	4x5	E5200	2.50	2MB	2	6GB	(2, 2, 2)	16-in-1	640GB	DVD±RW	GMA 3100				Prem 64	Jan 09
5359-2BU	4x5	E5200	2.50	2MB	2	6GB	(2, 2, 2)	16-in-1	640GB	DVD±RW	GMA 3100				Prem 64	Jan 09
5359-3EU	4x5	E7300	2.66	3MB	2	6GB	(2, 2, 2)	16-in-1	1TB	DVD±RW	GMA 3100			11b/g	Prem 64	Jan 09
5359-3AU	4x5	E7400	2.80	3MB	2	6GB	(2, 2, 2)	16-in-1	640GB	DVD±RW	GMA 3100				Prem 64	Jan 09
5359-4CU	4x5	Q8200	2.33	4MB	4	6GB	(2, 2, 2)	16-in-1	640GB	DVD±RW	GMA 3100				Prem 64	Jan 09
5359-4DU	4x5	Q8200	2.33	4MB	4	8GB	(2, 2, 2, 2)	16-in-1	1TB	DVD±RW	9300 GE			11b/g	Prem 64	Jan 09
5359-5AU	4x5	Q9400	2.66	6MB	4	8GB	(2, 2, 2, 2)	16-in-1	1TB	Blu-ray	9300 GE	TV	Remote	11b/g	Prem 64	Jan 09

- **Antibacterial keyboard uses special material on the surface of the keys to restrain bacterial growth**
- **Lenovo Rescue System provides OneKey recovery and OneKey Antivirus without booting into Windows**

Processor	Intel® Pentium® Dual-Core Processor E2220 or E5200 with dual-core , 800MHz system bus; <i>E2220</i> : 1MB L2 cache; <i>E5200</i> : 2MB L2 cache or Intel Core™ 2 Duo Processor E7300 or E7400 with dual-core 1066MHz system bus, and 3MB L2 cache or Intel Core 2 Quad Processor Q8200 or Q9400 with quad-core (dual-core on dual-die), 1333MHz system bus; <i>Q8200</i> : 4MB L2 cache; <i>Q9400</i> : 6MB L2 cache Processor in FC-LGA6 package in LGA775 socket	Tower • Black color bezel • 7.1" W X 17.0" D X 15.0" H • 180mm W X 432mm D X 380mm H • 21.5 lb (9.75 kg) • Toolless cover removal • Toolless disk, optical drive removal • Toolless adapter retention
Implementation	Processor in FC-LGA6 package in LGA775 socket	
Memory	4GB, 5GB, 6GB, or 8GB std , 8GB max ⁹ , PC2-5300 667MHz DDR2 , non-parity, dual-channel capable, four 240-pin DIMM sockets	Bay ① 5.25", 1.6" high, access, standard optical Bay ② 5.25", 1.6" high, access, open Bay ③ 3.0", 1" high, access, 16-in-1 media reader Bay ④ 3.5", 1" high, no access, standard disk Bay ⑤ 3.5", 1" high, no access, optional disk
Graphics	<i>Some</i> : Intel Graphics Media Accelerator 3100 (GMA 3100) , integrated graphics in G33, uses main memory, one 15-pin analog VGA DB-15 connector <i>Some</i> : NVIDIA® GeForce® 9300 GE , PCI Express® x16, 512MB memory, DirectX® 10, TurboCache, PureVideo™ HD technology, S-video out for TV-out, VGA DB-15 connector, DVI-I connector, HDCP-compliant	Slot 1: half-length, full-height, PCI Express x16 Ver 1.1 ** Slot 2: half-length, full-height, PCI Express x1 Ver 1.1 * Slot 3: half-length, full-height, PCI Express x1 Ver 1.1 * Slot 4: half-length, full-height, 32-bit PCI Ver 2.3
SATA disk	500GB, 640GB, or 1TB SATA 3Gb/s, 7200 rpm	Slot 1: half-length, full-height, PCI Express x16 Ver 1.1 ** Slot 2: half-length, full-height, PCI Express x1 Ver 1.1 * Slot 3: half-length, full-height, PCI Express x1 Ver 1.1 * Slot 4: half-length, full-height, 32-bit PCI Ver 2.3
SATA controller	Serial ATA, SATA 3.0Gb/s, integrated in ICH9DH	* Wireless adapter or TV tuner in slot in some models ** used in some models
SATA DVD±RW	<i>Some</i> : Multi-Burner DL DVD±RW SATA 1.5Gb/s Drive	
SATA Blu-ray™	<i>Some</i> : Blu-ray Disc reader (no Blu-ray media burning), BD-ROM, DVD and CD recordable	
SATA cables	Two SATA cables (each 1-drop to device), four SATA connectors	
EIDE controller	None	
Diskette drive	None	
Media reader	16-in-1 media reader, internal USB 2.0	
Chipset	Intel G33 Express Chipset (PCI Express® x16), I/O Controller Hub 9 Digital Home [ICH9DH] (SATA 3.0Gb/s, PCI Express x1, ethernet MAC, PCI 2.3, USB, LPC bus), SMSC® SCH5617 Super I/O	
Front ports	Two USB 2.0, microphone (stereo, 3.5mm), headphone (stereo, 3.5mm)	
Rear ports	Four USB 2.0, one serial (9-pin), parallel (25-pin), keyboard (PS/2), mouse (PS/2), ethernet (RJ-45), <i>4DU/5AU</i> : monitor (VGA DB-15, DVI-I), S-Video out; <i>Others</i> : monitor (VGA DB-15)	
Rear audio ports	Line-in (stereo, 3.5mm), line-out (stereo, 3.5mm), microphone-in (stereo, 3.5mm), SPDIF-out	
Audio	High Definition (HD) audio, ADI1988 codec	
External speakers	None	
Internal speaker	None	
Ethernet	Gigabit ethernet on planar, Intel 82256GC	
Wireless	<i>Some</i> : 11b/g wireless ⁴ , Broadcom® BCM4312, PCIe x1 adapter	
Modem	None	
Security chip	None	
TV tuner	<i>Some</i> : Hybrid tuner, support analog (NTSC) and digital (ATSC) signal , Hauppauge WinTV-HVR-1250, PCIe x 1	
Remote control	<i>Some</i> : Philips® Vista MCE remote control (40-button), IR receiver via USB	
Camera	None	
Keyboard	104-key antibacterial keyboard (PS/2 connector)	
Mouse	Optical Wheel Mouse (USB connector), 400 dpi	
Power supply	280 watts, universal, manual switch	
Preloaded operating system²⁰	- Microsoft® Windows® Vista® Home Premium Edition (64-bit) ◇ <i>5359-4DU/5AU</i> : Vista Premium logo ◇ <i>Others</i> : Vista Basic logo	
Preloaded applications⁵	• Lenovo® OneKey Recovery • Driver and Application Installation • Trend Micro™ PC-cillin™ Internet Security 2008 • Windows Live™ Toolbar • Microsoft Office 2007 Trial (60-day) • Corel® WinDVD® (DVD±RW, Blu-ray) • CyberLink Power2Go (DVD±RW, Blu-ray)	



Available at these retailers

- lenovo.com
- Circuit City®
- Fry's

Limited Warranty¹

- ⇒ **1-year parts and labor**
- ⇒ **Customer Replaceable Unit (CRU) parts only (with limited onsite service for selected parts³, 8 am - 5 pm, Mon - Fri coverage excluding holidays, next business day response time)**
- ⇒ **Service upgrade options (in eligible locations):⁹**
 - 3-year Lenovo Onsite Repair 9x5 Next Business Day (43R8882)
- ⇒ **24x7¹⁴ toll-free support for warranty issues during the warranty period¹ via 877-453-6686**

See footnotes for important warranty information
US models announced January 13, 2009

**Partial list of accessories supported on:
IdeaCentre K210, K220, and K230****Storage and removable storage**

USB 2.0 MyKey E10 Flash Drive 1GB	45J7701	ann 04/29/08
USB 2.0 MyKey E10 Flash Drive 2GB	45J7702	ann 04/29/08
USB 2.0 MyKey E10 Flash Drive 4GB	45J7703	ann 04/29/08
USB 2.0 MiniKey M10D1 Flash 2GB (gray)	45J7752	ann 05/20/08
USB 2.0 MiniKey M10D2 Flash 2GB (black)	45J7754	ann 05/20/08
USB 2.0 MiniKey M10E1 Flash 2GB (teal)	45J7756	ann 05/20/08
USB 2.0 MiniKey M10E2 Flash 2GB (pink)	45J7758	ann 05/20/08
USB 2.0 Essential Memory Key 4GB	45J7904	ann 06/24/08
USB 2.0 Essential Memory Key 8GB	45J7905	ann 07/15/08
USB 2.0 Essential Memory Key 32GB	45K1258	ann 10/28/08
USB 2.0 Security Memory Key 1GB	41U5118	ann 07/17/07
USB 2.0 Security Memory Key 2GB	41U5119	ann 07/17/07
USB 2.0 Security Memory Key 4GB	41U5120	ann 07/17/07
USB 2.0 DataSlim E16 Portable HD 160GB	45J7700	ann 04/29/08
USB 2.0 Portable 160GB Hard Disk	43R1784	ann 09/23/08
USB 2.0 Portable Secure 160GB Hard Disk	43R2018	ann 11/18/08
USB 2.0 Portable Secure 320GB Hard Disk	43R2019	ann 11/18/08

Keyboard

Preferred Pro USB Keyboard	73P5220	ann 06/21/05
Enhanced Performance USB Keyboard	73P2620	ann 03/23/04
Wireless Kybd & Opt Wheel Mouse (via USB)	73P4067	ann 12/07/04
USB Keyboard with UltraNav	31P8950	ann 01/28/03
USB Travel Keyboard with UltraNav	31P9490	ann 04/27/04

Mouse

Laser Tilt Wheel Mouse (USB, PS/2)	41U3074	ann 01/23/07
IdeaPad Mini Optical Mouse M10 (black)	47J7729	ann 06/17/08
IdeaPad Mini Optical Mouse M10A (black)	45J7730	ann 07/15/08
Lenovo Mini Optical Mouse M30 (black)	47J7735	ann 06/17/08
Lenovo Mini Optical Mouse M30 (white)	47J7736	ann 06/17/08
Lenovo Mini Optical Mouse M30 (red)	47J7737	ann 06/17/08
Lenovo Mini Optical Mouse M30 (blue)	47J7738	ann 06/17/08
Mini Wireless Laser Mouse N10 (black)	45J7731	ann 06/17/08
Mini Wireless Laser Mouse N10 (red)	45J7732	ann 06/17/08

Monitors

ThinkVision® L174 17" Monitor	9227AE1	ann 04/15/08
ThinkVision L1700p 17" Monitor	9417HE2	ann 09/17/08
ThinkVision L1900p 19" Monitor	4431HE1	ann 11/11/08
ThinkVision L1940p Wide 19" Monitor	4424HB6	ann 09/17/08
ThinkVision L200p Wide 20.1" Monitor	4438HB6	ann 04/15/08
ThinkVision L2240p Wide 22" Monitor	4422HB6	ann 09/17/08
ThinkVision L2440p Wide 24" Monitor	4420HB2	ann 09/17/08
ThinkVision L2440x Wide 24" Monitor	4421HB2	ann 09/17/08

Monitor Accessories⁴⁶

ThinkVision USB Soundbar	40Y7616	ann 08/23/05
ThinkVision Soundbar (L1900p, 24" Wide)	45K1263	ann 09/16/08
Kensington Cable Lock from Lenovo	73P2582	ann 12/29/03
Kensington Twin Head Cable Lock	45K1620	ann 09/30/08
ThinkPad Convertible Monitor Stand	40Y7620	ann 01/05/06
Radial Arm	19K4464	ann 05/05/00

⁴⁶ Compatible on selected ThinkVision monitors.More information at www.lenovo.com/support/monitoraccessories**Consumer monitors**

Lenovo L195 Wide 19" LCD Monitor	4418HC1	ann 09/02/08
Lenovo L222 Wide 22" LCD Monitor	4432HF1	ann 09/02/08

Other accessories at www.lenovo.com/accessoriesAccessories Guide pdf at www.lenovo.com/accessoriesguide

Availability: All offers subject to availability. Lenovo reserves the right to alter product offerings and specifications at any time, without notice. Lenovo is not responsible for photographic or typographic errors.

Warranty: For a copy of applicable product warranties, write to: Warranty Information, P.O. Box 12195, RTP, NC, 27709, Attn: Dept ZPYA/B676. Lenovo makes no representation or warranty regarding third party products or services.

- ¹ **Limited warranty:** Support unrelated to a warranty issue may be subject to additional charges.
- ² **Hard disk drive:** GB = billion bytes, TB = trillion bytes. Accessible capacity is less; up to 4GB is service partition.
- ³ **Customer Replacement Units (CRUs)** are designed to be replaced by customers during the applicable warranty period. Lenovo will send a technician onsite to perform a repair if remote telephone diagnosis does not isolate the problem, if customer replaceable parts are unable to resolve the problem, or at the request of the customer. For a list of customer replaceable parts, contact Lenovo. Support unrelated to a warranty issue may be subject to additional charges.
- ⁵ **Included software** may differ from its retail version (if available), and may not include user manuals or all program functionality. License agreements may apply.

⁸ **Memory:** For PCs without a separate video card, memory supports both system and video. Accessible system memory is less than the amount stated, depending on video mode.

⁹ **Service upgrade options:** Service period begins with the equipment date of purchase. Service must be purchased during the original limited product warranty period. Service levels are response time objectives and are not guarantees.

¹⁰ **Modem speeds:** Public network download speeds are limited to 53Kbps. Upload speeds are limited to 48Kbps for V.92 modems. Actual speeds depend on many factors and are often less than the maximum possible. V.92 functions and speeds require compatible phone line and server equipment. Check with your telephone and ISP service providers for availability.

¹⁴ **Response times may vary.** May exclude some holidays. Telephone support may be subject to additional charges.

²⁰ **Operating System:** Level of support varies by operating system. Operating systems not preloaded on the system may not provide full feature functionality. Refer to lenovo.com/pc/support and enter your machine type and model number for more information.



This publication was developed for products and services offered in the United States. Lenovo may not offer the products, services or features discussed in this document in other countries. Lenovo may withdraw an offering at any time. Information is subject to change without notice. Consult your local representative for information on offerings available in your area.

Lenovo reserves the right to change specifications and other product information at any time without prior notice. Lenovo is not responsible for photographic or typographical errors. **LENOVO PROVIDES THIS PUBLICATION "AS IS" WITHOUT WARRANTY OF ANY KIND, EITHER EXPRESS OR IMPLIED, INCLUDING THE IMPLIED WARRANTIES OF MERCHANTABILITY OR FITNESS FOR A PARTICULAR PURPOSE.** Some jurisdictions do not allow disclaimer of express or implied warranties in certain transactions; therefore this disclaimer may not apply to you.

Trademarks: Lenovo, the Lenovo logo, New World. New Thinking., Access Connections, Rescue and Recovery, ThinkVantage, and ThinkVision are trademarks of Lenovo. Microsoft, Windows, and Vista are registered trademarks of Microsoft Corporation. Intel, the Intel logo, Intel Inside logo, Intel Core and Core Inside are trademarks of Intel Corporation in the US and other countries. AMD, the AMD logo, AMD Athlon, AMD Sempron, and combinations thereof, are trademarks of Advanced Micro Devices, Inc. PCI Express is a trademark of PCI-SIG. Other company, product, or service names may be trademarks or service marks of others.

Visit www.lenovo.com/safecomputing periodically for the latest information on safe and effective computing.

Visit www.lenovo.com/psref for the latest version of Personal Systems Reference.

© Lenovo, 2009.
All rights reserved.

Lenovo
1009 Think Place
Morrisville, NC 27560
U.S.A.

January 2009
icbook.pdf



Personal Systems Reference Lenovo® Consumer Monitors

January 2009 - Version 350



Lenovo L222 Wide Monitor

Visit www.lenovo.com/psref for the latest version

Flat Panel Monitors - US model		FEATURES
<p>Name Case color Part number Stand Screen Viewable image size Aspect ratio Pixel pitch (mm) Max view area (inches) Max view area (mm) Viewing angle at 5:1 CR Viewing angle at 10:1 CR Video input Dual input</p> <p>Rotating screen Soundbar</p>	<p>Lenovo L195 Wide Flat Panel Monitor High gloss black 18002904 Tilt stand LCD Active Matrix TFT (Thin Film Transistor) 19.0" / 481mm (diagonal) 16:10 0.282mm 16.2" x 10.1" (horizontal x vertical) 410mm x 257mm (horizontal x vertical) 176° vertical, 176° horizontal 160° vertical, 160° horizontal Digital or analog (two separate connectors) Dual input (two different PCs attach to two different connectors; one PC shows image; select via button) None Installed on bottom of monitor, volumn control knob, two stereo speakers (3 watts), powered by monitor, microphone input jack, headphone jack</p>	<ul style="list-style-type: none"> • All-purpose 19-inch wide flat panel LCD monitor • View images in a 16x10 wide aspect ratio • Slim 14.3mm (0.56") side bezel • High-bandwidth Digital Content Protection (HDCP)-compliant • Resolution of 1440x900 provides crisp screen images • Stand tilts for comfortable viewing • Rear stand cover to hide cables for easy cable management • Soundbar with stereo speakers for daily audio usage • Direct access for automatic image setup, input selection, and NovoVision • NovoVision offers four modes (text, Internet, video, and split demo) and provides automatic contrast, brightness, color correction, and color enhancement • Integrated power supply eliminates the bulky power adapter for improved cable management • Matching design to IdeaCentre® systems • Microsoft® Windows® Vista™ Premium certified
<p>Optimum resolution Maximum resolution Vertical frequency Horizontal frequency Display colors (maximum) Preset display modes</p> <p>Presets / user settings Brightness Contrast ratio Pixel response time Scaling</p>	<p>1440x900 at 60Hz 1440x900 at 75Hz (137MHz maximum pixel rate) 50 to 76Hz 30 to 81kHz 16.7 million simultaneous colors VGA: 640x480 60, 72, 75Hz SVGA: 800x600 56, 60, 72, 75Hz XGA: 1024x768 60, 70, 75Hz SXGA: 1280x1024 60, 70, 72, 76Hz WXGA+: 1440x900 60, 75Hz Standard presets: 17; user settings: 15 300 nits or cd/m² (typical) 1000:1 (typical) 5ms (typical) Automatically expands image of lower resolution to full screen of 1440x900</p>	 <p>Lenovo L195 Wide</p>
<p>On screen display Control features</p> <p>Monitor connectors</p> <p>Signal cable</p> <p>Anti-reflective / anti-glare Dimensions Weight Viewing adjustments Mounting features Security</p>	<p>On screen display with digital user controls (7 languages) Direct access (buttons on front) for auto adjustment, input select, and NovoVision (4 preload modes, optimize visual experience for different usages); brightness; contrast; image horizontal and vertical position; user color settings (3 preset + 1 user); on screen display (OSD) language selection; menu position; information screen; image setup; reset of geometry and color point to factory default settings; lockable settings</p> <p>Two connectors: (1) analog 15-pin D-shell [blue] (2) Digital Visual Interface (DVI-D) for digital attach [white], HDCP-compliant</p> <p>Two cables: (1) detachable, 15-pin D-shell at each end (for analog connector), 1.8 meter, matches color of monitor (2) detachable, DVI-D at each end (for digital connector), 1.8 meter, matches color of monitor</p> <p>Anti-reflective / anti-glare 14.67" H x 17.36" W x 7.09" D / 373mm height x 441mm width x 180mm depth 10.2 lb / 4.6 kg Tilt: 20° back, 5° forward / no swivel / no lift / detachable stand None Security keyhole for attachment of optional cable lock (such as Kensington® Microsaver® lock)</p>	
<p>VESA DDC² VESA DPMS-compliant Power management Ergonomics Pixel defect Emission standards Environmental label Ship group</p> <p>Power supply</p> <p>Limited warranty⁴ Available date</p>	<p>DDC/CI DPMS ENERGY STAR^{®3} 4.0 ISO 13406 Part 2¹ ISO 13406-2 Class II pixel defect standard MPR-2 / MPR-3A / FCC Class B WEEE / RoHS (EU Directive 2002/95/EC) Monitor, attached stand, customer installable base, soundbar, Setup Guide, Safety and Warranty Information, CD with multilingual User's Guide and monitor installation files, analog signal cable, digital signal cable, 1.8m black power cord 100-240Vac (universal) / integrated (no external brick-like power supply) / 48 watts maximum (with soundbar), <2 watts for "active off" 1 year (includes backlight) August 2008</p>	
<p>LIMITED WARRANTY</p> <ul style="list-style-type: none"> ↪ 1-year limited warranty⁴ ↪ Rapid Replacement Service at 1-877-453-6686 ↪ Replacement normally arrives in two business days, excluding holidays ↪ Lenovo pays all shipping costs for valid warranty claims⁶ ↪ 24x7⁵ day toll-free support for warranty issues during the warranty period⁴ 		

See footnotes for important warranty information
US model announced August 5, 2008

Flat Panel Monitors - US model		FEATURES																											
Name	Lenovo L195 Wide Flat Panel Monitor	<ul style="list-style-type: none"> • All-purpose 19-inch wide flat panel LCD monitor • View images in a 16x10 wide aspect ratio • Slim 14.3mm (0.56") side bezel • High-bandwidth Digital Content Protection (HDCP)-compliant • Resolution of 1680x1050 provides crisp screen images • Stand tilts for comfortable viewing • Rear stand cover to hide cables for easy cable management • Soundbar with stereo speakers for daily audio usage • Direct access for automatic image setup, input selection, and NovoVision • NovoVision offers four modes (text, Internet, video, and split demo) and provides automatic contrast, brightness, color correction, and color enhancement • Integrated power supply eliminates the bulky power adapter for improved cable management • Matching design to IdeaCentre® systems • Microsoft® Windows® Vista™ Premium certified 																											
Case color	High gloss black																												
Type-model	4418-HC1																												
Stand	Tilt stand																												
Screen	LCD Active Matrix TFT (Thin Film Transistor)																												
Viewable image size	19.0" / 481mm (diagonal)																												
Aspect ratio	16:10																												
Pixel pitch (mm)	0.243mm																												
Max view area (inches)	16.1" x 10.0" (horizontal x vertical)																												
Max view area (mm)	408mm x 255mm (horizontal x vertical)																												
Viewing angle at 10:1 CR	160° vertical, 170° horizontal																												
Video input	Digital or analog (two separate connectors)																												
Dual input	Dual input (two different PCs attach to two different connectors; one PC shows image; select via button)																												
Rotating screen	None																												
Soundbar	Installed on bottom of monitor, volume control knob, two stereo speakers (3 watts), powered by monitor, microphone input jack, headphone jack																												
Optimum resolution	1680x1050 at 60Hz																												
Maximum resolution	1680x1050 at 60Hz (137MHz maximum pixel rate)																												
Vertical frequency	50 to 76Hz																												
Horizontal frequency	30 to 81kHz																												
Display colors (maximum)	16.7 million simultaneous colors																												
Preset display modes	<table border="0"> <tr> <td>640x350</td> <td>70Hz</td> </tr> <tr> <td>PAL VGA: 640x480</td> <td>50Hz</td> </tr> <tr> <td>VGA: 640x480</td> <td>60, 66, 72, 75Hz</td> </tr> <tr> <td>720x400</td> <td>70Hz</td> </tr> <tr> <td>SVGA: 800x600</td> <td>56, 60, 72, 75Hz</td> </tr> <tr> <td>832x624</td> <td>75Hz</td> </tr> <tr> <td>XGA: 1024x768</td> <td>60, 70, 75Hz</td> </tr> <tr> <td>1152x864</td> <td>75Hz</td> </tr> <tr> <td>1280x720</td> <td>60Hz</td> </tr> <tr> <td>1280x768</td> <td>60Hz</td> </tr> <tr> <td>1280x960</td> <td>60Hz</td> </tr> <tr> <td>SXGA: 1280x1024</td> <td>60, 70, 75, 76Hz</td> </tr> <tr> <td>WXGA+: 1440x900</td> <td>60, 75Hz</td> </tr> <tr> <td>WSXGA+: 1680x1050</td> <td>60Hz</td> </tr> </table>	640x350	70Hz	PAL VGA: 640x480	50Hz	VGA: 640x480	60, 66, 72, 75Hz	720x400	70Hz	SVGA: 800x600	56, 60, 72, 75Hz	832x624	75Hz	XGA: 1024x768	60, 70, 75Hz	1152x864	75Hz	1280x720	60Hz	1280x768	60Hz	1280x960	60Hz	SXGA: 1280x1024	60, 70, 75, 76Hz	WXGA+: 1440x900	60, 75Hz	WSXGA+: 1680x1050	60Hz
640x350	70Hz																												
PAL VGA: 640x480	50Hz																												
VGA: 640x480	60, 66, 72, 75Hz																												
720x400	70Hz																												
SVGA: 800x600	56, 60, 72, 75Hz																												
832x624	75Hz																												
XGA: 1024x768	60, 70, 75Hz																												
1152x864	75Hz																												
1280x720	60Hz																												
1280x768	60Hz																												
1280x960	60Hz																												
SXGA: 1280x1024	60, 70, 75, 76Hz																												
WXGA+: 1440x900	60, 75Hz																												
WSXGA+: 1680x1050	60Hz																												
Presets / user settings	Standard presets: 26; user settings: 27																												
Brightness	300 nits or cd/m ² (typical)																												
Contrast ratio	1000:1 (typical)																												
Pixel response time	5ms (typical)																												
Scaling	Automatically expands image of lower resolution to full screen of 1680x1050																												
On screen display	On screen display with digital user controls (7 languages)																												
Control features	Direct access (buttons on front) for auto adjustment, input select, and NovoVision (4 preload modes, optimize visual experience for different usages); brightness; contrast; image horizontal and vertical position; user color settings (3 preset + 1 user); on screen display (OSD) language selection; menu position; information screen; image setup; reset of geometry and color point to factory default settings; lockable settings																												
Monitor connectors	Two connectors: (1) analog 15-pin D-shell [blue]																												
Signal cable	Two cables: (2) Digital Visual Interface (DVI-D) for digital attach [white], HDCP-compliant (1) detachable, 15-pin D-shell at each end (for analog connector), 1.8 meter, matches color of monitor (2) detachable, DVI-D at each end (for digital connector), 1.8 meter, matches color of monitor																												
Anti-reflective / anti-glare	Anti-reflective / anti-glare																												
Dimensions	14.67" H x 17.36" W x 7.09" D / 373mm height x 441mm width x 180mm depth																												
Weight	10.1 lb / 4.6 kg																												
Viewing adjustments	Tilt: 20° back, 5° forward / no swivel / no lift / detachable stand																												
Mounting features	None																												
Security	Security keyhole for attachment of optional cable lock (such as Kensington® Microsaver® lock)																												
VESA DDC ²	DDC/CI																												
VESA DPMS-compliant	DPMS																												
Power management	ENERGY STAR ^{®3} 4.0																												
Ergonomics	ISO 13406 Part 2 ¹																												
Pixel defect	ISO 13406-2 Class II pixel defect standard																												
Emission standards	MPR-2 / MPR-3A / FCC Class B																												
Environmental label	WEEE / RoHS (EU Directive 2002/95/EC)																												
Ship group	Monitor, attached stand, customer installable base, soundbar, Setup Guide, Safety and Warranty Information, CD with multilingual User's Guide and monitor installation files, analog signal cable, digital signal cable, 1.8m black power cord																												
Power supply	100-240Vac (universal) / integrated (no external brick-like power supply) / 48 watts maximum (with soundbar), <2 watts for "active off"																												
Limited warranty ⁴	1 year (includes backlight)																												
Available date	September 2008																												



Lenovo L195 Wide

LIMITED WARRANTY	
↪	1-year limited warranty⁴
↪	Rapid Replacement Service at 1-877-453-6686
↪	Replacement normally arrives in two business days, excluding holidays
↪	Lenovo pays all shipping costs for valid warranty claims⁵
↪	24x7³ day toll-free support for warranty issues during the warranty period⁴

See footnotes for important warranty information
US model announced September 2, 2008

Flat Panel Monitors - US model		FEATURES
Name	Lenovo L222 Wide Flat Panel Monitor	<ul style="list-style-type: none"> • All-purpose 22-inch wide flat panel LCD monitor • View images in a 16x10 wide aspect ratio • Slim 15 mm (0.59") side bezel • High-bandwidth Digital Content Protection (HDCP)-compliant • Resolution of 1680x1050 provides crisp screen images • Stand tilts and swivels for comfortable viewing • Rear stand cover to hide cables for easy cable management • One key release stand for wall mounting • Touch-sensitive buttons for all monitor control features • Direct access for automatic image setup, input selection, and NovoVision • NovoVision offers four modes (text, Internet, video, and split demo) and provides automatic contrast, brightness, color correction, and color enhancement • Integrated power supply eliminates the bulky power adapter for improved cable management • Matching design to IdeaCentre® systems • Microsoft® Windows® Vista™ Premium certified
Case color	High gloss black	
Part number	18002819	
Stand	Tilt and swivel stand	
Screen	LCD Active Matrix TFT (Thin Film Transistor)	
Viewable image size	22.0" / 559mm (diagonal)	
Aspect ratio	16:10	
Pixel pitch (mm)	0.282mm	
Max view area (inches)	18.7" x 11.6" (horizontal x vertical)	
Max view area (mm)	474mm x 296mm (horizontal x vertical)	
Viewing angle at 5:1 CR	176° vertical, 176° horizontal	
Viewing angle at 10:1 CR	160° vertical, 160° horizontal	
Video input	Digital or analog (two separate connectors)	
Dual input	Dual input (two different PCs attach to two different connectors; one PC shows image; select via button)	
Rotating screen	None	
Soundbar	Installed on bottom of monitor, volume control knob, two stereo speakers (3 watts), powered by monitor, microphone input jack, headphone jack	
Optimum resolution	1680x1050 at 60Hz	 <p style="text-align: center;">Lenovo L222 Wide</p>
Maximum resolution	1680x1050 at 60Hz (146MHz maximum pixel rate)	
Vertical frequency	56 to 76Hz	
Horizontal frequency	30 to 83kHz	
Display colors (maximum)	16.7 million simultaneous colors	
Preset display modes	VGA: 640x480 60, 72, 75Hz 720x400 70Hz SVGA: 800x600 56, 60Hz, 75Hz 832x624 75Hz XGA: 1024x768 60, 70, 75Hz 1152x864 75Hz SXGA: 1280x1024 60, 70, 75, 76Hz WXGA+: 1440 x 900 60, 75Hz WSXGA+: 1680x1050 60Hz	
Presets / user settings	Standard presets: 17; user settings: 17	
Brightness	300 nits or cd/m ² (typical)	
Contrast ratio	1000:1 (typical)	
Pixel response time	5ms (typical)	
Scaling	Automatically expands image of lower resolution to full screen of 1680x1050	
On screen display	On screen display with digital user controls (7 languages), touch-sensitive control buttons	
Control features	Direct access (touch buttons on front) for auto adjustment, input select, and NovoVision (4 preload modes, optimize visual experience for different usages); brightness; contrast; image horizontal and vertical position; user color settings (3 preset + 1 user); on screen display (OSD) language selection; menu position; information screen; image setup; reset of geometry and color point to factory default settings; lockable settings	
Monitor connectors	Two connectors: (1) analog 15-pin D-shell [blue], (2) Digital Visual Interface (DVI-D) for digital attach [white], HDCP-compliant	
Signal cable	Two cables: (1) detachable, 15-pin D-shell at each end (for analog connector), 1.8 meter, matches color of monitor (2) detachable, DVI-D at each end (for digital connector), 1.8 meter, matches color of monitor	
Anti-reflective / anti-glare	Anti-reflective / anti-glare	
Dimensions	16.13" H x 19.89" W x 7.48" D / 410mm height x 505mm width x 190mm depth	
Weight	12.8 lb / 5.8 kg	
Viewing adjustments	Tilt: 20° back, 5° forward / swivel: +/-175° / no lift / detachable stand	
Mounting features	Wall or desk mounting using or third-party accessories meeting the VESA FPMPI® (100mm mount)	
Security	Security keyhole for attachment of optional cable lock (such as Kensington® Microsaver® lock)	
VESA DDC ²	DDC/CI	
VESA DPMS-compliant	DPMS	
Power management	ENERGY STAR® 4.0	
Ergonomics	ISO 13406 Part 2 ¹	
Pixel defect	ISO 13406-2 Class II pixel defect standard	
Emission standards	MPR-2 / MPR-3A / FCC Class B	
Environmental label	WEEE / RoHS (EU Directive 2002/95/EC)	
Ship group	Monitor, attached stand, customer installable base, soundbar, Setup Guide, Safety and Warranty Information, CD with multilingual User's Guide and monitor installation files, analog signal cable, digital signal cable, 1.8m black power cord	
Power supply	100-240Vac (universal) / integrated (no external brick-like power supply) / 56 watts maximum (with soundbar), <2 watts for "active off"	
Limited warranty ⁴	1 year (includes backlight)	
Available date	August 2008	
LIMITED WARRANTY		
<ul style="list-style-type: none"> ↪ 1-year limited warranty⁴ ↪ Rapid Replacement Service at 1-877-453-6686 ↪ Replacement normally arrives in two business days, excluding holidays ↪ Lenovo pays all shipping costs for valid warranty claims⁶ ↪ 24x7⁵ day toll-free support for warranty issues during the warranty period⁴ 		

See footnotes for important warranty information
US model announced August 5, 2008

Flat Panel Monitors - US model		FEATURES
Name	Lenovo L222 Wide Flat Panel Monitor	<ul style="list-style-type: none"> • All-purpose 22-inch wide flat panel LCD monitor • View images in a 16x10 wide aspect ratio • Slim 15 mm (0.59") side bezel • High-bandwidth Digital Content Protection (HDCP)-compliant • Resolution of 1920x1200 provides crisp screen images • High Definition (HD) ready; supports 1080p video • Stand tilts and swivels for comfortable viewing • Rear stand cover to hide cables for easy cable management • One key release stand for wall mounting • Touch-sensitive buttons for all monitor control features • Direct access for automatic image setup, input selection, and NovoVision • NovoVision offers four modes (text, Internet, video, and split demo) and provides automatic contrast, brightness, color correction, and color enhancement • Matching design to IdeaCentre® systems • Microsoft® Windows® Vista™ Premium certified
Case color	High gloss black	
Type-model	4432-HF1	
Stand	Tilt and swivel stand	
Screen	LCD Active Matrix TFT (Thin Film Transistor)	
Viewable image size	22.0" / 559mm (diagonal)	
Aspect ratio	16:10	
Pixel pitch (mm)	0.247mm	
Max view area (inches)	18.7" x 11.6" (horizontal x vertical)	
Max view area (mm)	474mm x 296mm (horizontal x vertical)	
Viewing angle at 10:1 CR	160° vertical, 170° horizontal	
Video input	Digital or analog (two separate connectors)	
Dual input	Dual input (two different PCs attach to two different connectors; one PC shows image; select via button)	
Rotating screen	None	
Soundbar	Installed on bottom of monitor, volume control knob, two stereo speakers (3 watts), powered by monitor, microphone input jack, headphone jack	
Optimum resolution	1920x1200 at 60Hz	 <p style="text-align: center;">Lenovo L222 Wide</p>
Maximum resolution	1920x1200 at 60Hz (205MHz maximum pixel rate)	
Vertical frequency	50 to 75Hz	
Horizontal frequency	30 to 83kHz	
Display colors (maximum)	16.7 million simultaneous colors	
Preset display modes	VGA: 640x480 60Hz SVGA: 800x600 56, 60Hz XGA: 1024x768 60Hz SXGA: 1280x1024 60Hz WXGA+: 1440 x 900 60Hz WSXGA+: 1680x1050 60Hz WSXGA+: 1680x1050 60Hz WUXGA: 1920x1200 60Hz	
Presets / user settings	Standard presets: 8; user settings: 10	
Brightness	300 nits or cd/m ² (typical)	
Contrast ratio	1000:1 (typical)	
Pixel response time	5ms (typical)	
Scaling	Automatically expands image of lower resolution to full screen of 1920x1200	
On screen display	On screen display with digital user controls (7 languages), touch-sensitive control buttons	
Control features	Direct access (touch buttons on front) for auto adjustment, input select, and NovoVision (4 preload modes, optimize visual experience for different usages); brightness; contrast; image horizontal and vertical position; user color settings (3 preset + 1 user); on screen display (OSD) language selection; menu position; information screen; image setup; reset of geometry and color point to factory default settings; lockable settings	
Monitor connectors	Two connectors: (1) analog 15-pin D-shell [blue], (2) Digital Visual Interface (DVI-D) for digital attach [white], HDCP-compliant	
Signal cable	Two cables: (1) detachable, 15-pin D-shell at each end (for analog connector), 1.8 meter, matches color of monitor (2) detachable, DVI-D at each end (for digital connector), 1.8 meter, matches color of monitor	
Anti-reflective / anti-glare	Anti-reflective / anti-glare	
Dimensions	16.13" H x 19.89" W x 7.48" D / 410mm height x 505mm width x 190mm depth	
Weight	12.8 lb / 5.8 kg	
Viewing adjustments	Tilt: 20° back, 5° forward / swivel: +/-175° / no lift / detachable stand	
Mounting features	Wall or desk mounting using or third-party accessories meeting the VESA FPMPI® (100mm mount)	
Security	Security keyhole for attachment of optional cable lock (such as Kensington® Microsaver® lock)	
VESA DDC ²	DDC/CI	
VESA DPMS-compliant	DPMS	
Power management	ENERGY STAR® 4.0	
Ergonomics	ISO 13406 Part 2 ¹	
Pixel defect	ISO 13406-2 Class II pixel defect standard	
Emission standards	MPR-2 / MPR-3A / FCC Class B	
Environmental label	WEEE / RoHS (EU Directive 2002/95/EC)	
Ship group	Monitor, attached stand, customer installable base, soundbar, Setup Guide, Safety and Warranty Information, CD with multilingual User's Guide and monitor installation files, analog signal cable, digital signal cable, 1.8m black power cord	
Power supply	100-240Vac (universal) / integrated (no external brick-like power supply) / 56 watts maximum (with soundbar), <2 watts for "active off"	
Limited warranty ⁴	1 year (includes backlight)	
Available date	September 2008	
LIMITED WARRANTY		
<ul style="list-style-type: none"> ↪ 1-year limited warranty⁴ ↪ Rapid Replacement Service at 1-877-453-6686 ↪ Replacement normally arrives in two business days, excluding holidays ↪ Lenovo pays all shipping costs for valid warranty claims⁶ ↪ 24x7⁹ day toll-free support for warranty issues during the warranty period⁴ 		

See footnotes for important warranty information
US model announced September 2, 2008



Availability: All offers subject to availability. Lenovo reserves the right to alter product offerings and specifications at any time, without notice. Lenovo is not responsible for photographic or typographic errors.

Warranty: For a copy of applicable product warranties, write to: Warranty Information, P.O. Box 12195, RTP, NC, 27709, Attn: Dept ZPYA/B676. Lenovo makes no representation or warranty regarding third party products or services.

- ¹ **ISO-compliant:** Compliance with ISO 9241 Part 3, ISO Part 7, ISO Part 8, and/or ISO 13406 Part 2 is dependent on a complete ISO-capable platform of a system unit, monitor, video subsystem, operating system and fonts.
- ² **VESA:** Requires attachment to suitably configured system with similarly enabled operating system.
- ³ **ENERGY STAR:** As an ENERGY STAR partner, Lenovo has determined that this product meets the ENERGY STAR 4.0 or 4.1 guidelines for energy efficiency. Requires attachment to suitably configured system.
- ⁴ **Limited warranty:** Support unrelated to a warranty issue may be subject to additional charges.
- ⁶ **Lenovo pays all shipping costs** for warranty repairs during limited warranty period.
- ⁸ **Telephone support** may be subject to additional charges, even during the limited warranty period. In the United States call 877-453-6686. Response times may vary. May exclude some holidays.

Trademarks: Lenovo, the Lenovo logo, New World. New Thinking., Access Connections, Rescue and Recovery, ThinkCentre, ThinkPad, ThinkStation, ThinkVantage, and ThinkVision are trademarks of Lenovo. Microsoft, Windows, and Vista are registered trademarks of Microsoft Corporation. Other company, product, or service names may be trademarks or service marks of others.

This publication was developed for products and services offered in the United States. Lenovo may not offer the products, services or features discussed in this document in other countries. Lenovo may withdraw an offering at any time. Information is subject to change without notice. Consult your local representative for information on offerings available in your area.

Lenovo reserves the right to alter specifications and other product information at any time without prior notice. Lenovo is not responsible for photographic or typographical errors. **LENOVO PROVIDES THIS PUBLICATION "AS IS" WITHOUT WARRANTY OF ANY KIND, EITHER EXPRESS OR IMPLIED, INCLUDING THE IMPLIED WARRANTIES OF MERCHANTABILITY OR FITNESS FOR A PARTICULAR PURPOSE.** Some jurisdictions do not allow disclaimer of express or implied warranties in certain transactions; therefore this disclaimer may not apply to you. This publication was developed in the US.

Visit www.lenovo.com/safecomputing periodically for the latest information on safe and effective computing.

Visit www.lenovo.com/psref for the latest version of Personal Systems Reference.

© Lenovo, 2009.
All rights reserved.

Lenovo
1009 Think Place
Morrisville, NC 27560
U.S.A.

January 2009
cmbook.pdf



Personal Systems Reference *Lenovo® 3000 Notebooks*

January 2009 - Version 350



Visit www.lenovo.com/psref for the latest version

Type-model	Processor	GHz	Memory	Widescreen display	Camera	Graphics controller	SATA disk	EIDE optical	Mini PCIe 802.11 wireless	Bluetooth	Fingerprint reader	Chip-set	Preload	Avail date
✕ 0769-ALU	Celeron 530	1.73	512MB	15.4" WXGA		GMA	80GB ⁸	Combo	Lenovo 11b/g ¹¹			GM	Home Basic	Oct 07
✕ 0769-AMU	Celeron 530	1.73	512MB	15.4" WXGA		GMA	80GB	Combo	Lenovo 11b/g			GM	XP Pro	Oct 07
✕ 0769-ANU	Pentium T2310	1.46	1GB	15.4" WXGA		GMA	120G	DVD±RW	Lenovo 11b/g		Finger	GM	XP Pro	Oct 07
✕ 0769-APU	Pentium T2310	1.46	1GB	15.4" WXGA	Cam	GMA	160G	DVD±RW	Lenovo 11b/g	Blue	Finger	GM	XP Pro	Oct 07
0769-ASU	Celeron 540	1.86	512MB	15.4" WXGA		GMA	80GB	Combo	Lenovo 11b/g			GM	Home Basic	Dec 07
0769-ATU	Celeron 540	1.86	512MB	15.4" WXGA		GMA	80GB	Combo	Lenovo 11b/g			GM	XP Pro	Dec 07
✕ 0769-AUU	Pentium T2330	1.60	1GB	15.4" WXGA		GMA	120G	DVD±RW	Lenovo 11b/g		Finger	GM	XP Pro	Dec 07
0769-AVU	Pentium T2330	1.60	1GB	15.4" WXGA	Cam	GMA	120G	DVD±RW	Lenovo 11b/g	Blue	Finger	GM	Home Prem	Dec 07
0769-F8U	Celeron 550	2.00	1GB	15.4" WXGA		GMA	80GB	Combo	Intel 11a/b/g ¹¹			GM	Home Basic	Apr 08
0769-F9U	Pentium T2390	1.86	1GB	15.4" WXGA	Cam	GMA	120G	DVD±RW	Intel 11a/b/g	Blue	Finger	GM	Home Prem	Apr 08
0769-FAU	Pentium T2390	1.86	1GB	15.4" WXGA		GMA	120G	DVD±RW	Intel 11a/b/g		Finger	GM	Business 32	Apr 08
0769-FBU	Celeron 550	2.00	1GB	15.4" WXGA		GMA	80GB	Combo	Lenovo 11b/g			GM	Business 32	May 08
Ⓢ 0769-FCU	Pentium T2390	1.86	1GB	15.4" WXGA		GMA	160G	DVD±RW	Intel 11n ²⁸		Finger	GM	XP Pro	Jun 08

These Lenovo 3000 N200 models use a 15.4" widescreen display

Positioning Processor	<p><i>Widescreen flexibility; two-spindle</i> Intel® Celeron® Processor 530, 540, or 550 with single-core, Execute Disable Bit, Intel 64 Technology, 533MHz system bus, and 1MB L2 cache or Intel Pentium® Dual-Core Processor T2310, T2330, or T2390 with dual-core, Intel 64 Technology, Execute Disable Bit, EIST, 533MHz system bus, and 1MB shared L2 cache</p>									<p>Preloaded operating system²⁰ - Some: Microsoft Windows XP Professional with Vista® COA - Some: Microsoft Windows Vista Home Basic Edition (32-bit) - Some: Microsoft Windows Vista Home Premium Ed (32-bit) - Some: Microsoft Windows Vista Business Edition (32-bit) ⇨ <i>Vista models:</i> Vista Basic logo</p>				
Memory	<p>512MB or 1GB std / 4GB max^{7/} PC2-5300 667MHz DDR2, non-parity, dual-channel capable, two 200-pin SO-DIMM sockets; <i>Non-italics:</i> standard memory in one socket; one socket available</p>									<p>Preloaded applications¹⁴ (all OSes) • Lenovo CareSM Tools - Rescue and RecoveryTM - System Update - Password Manager - Access ConnectionsTM • Norton Internet SecurityTM (90 days of virus definitions) • Softex OmniPass (on fingerprint models) • PC-DoctorTM (diagnostics) • Adobe® Reader • Picasa from Google • Diskeeper® Lite (XP models) • Diskeeper Home (Vista models) • Corel® Small Business CenterTM with WordPerfect® Office 12 • QuickBooks Financial Center • Network MagicTM (Vista only) • Windows LiveTM Toolbar • Windows Live Search • QuickBooks Financial Center (Vista only) • Microsoft Office 2007 Trial (60-day) • EarthLink (Vista Home Basic models only)</p>				
Diskette drive	None (use optional USB-based diskette drive)													
EIDE Combo	Some: DVD-ROM/CD-RW / 24X/24X/24X/8X ²¹ speed, fixed, not removable, 12.7mm													
EIDE DVD±RW	Some: DVD burner, dual-layer support, fixed, not removable, 12.7mm high													
SATA disk	80GB⁸ (5400 rpm), 120GB (5400 rpm), or 160GB (5400 rpm) / SATA 1.5Gb/s, 9.5mm high, removable and upgradable													
Widescreen display	15.4" (391.1mm) WXGA (1280x800) TFT color, VibrantView (glossy), CCFL backlight, 185 nits, 16:10 aspect ratio, 400:1 contrast ratio													
Camera	Some: camera on top of screen, 1.3-megapixel, fixed focus, internal USB 2.0													
Graphics	Intel Graphics Media Accelerator X3100 , in GM965													
Keyboard	Full-size keyboard, 6-row, 84-key, multimedia Fn keys, Lenovo Care SM button													
Touch pad	Two-button touch pad with scroll feature (no TrackPoint®)													
Dimensions ³	<p><i>6-cell (WxDxH):</i> 14.2"x 10.5"x 1.2" to 1.5"; 360.1mm x 266.7mm x 31.4 to 38.6mm; <i>9-cell (WxDxH):</i> 14.2"x 11.3"x 1.2" to 1.5"; 360.1mm x 286.6mm x 31.4 to 38.6mm with optical drive and battery: <i>6-cell:</i> 6.02 lb to 6.34 lb (2.73 to 2.88 kg)</p>													
Weight ²	Silver top; silver bottom													
Case color	ABS plastic													
Case material	Lithium Ion 6-cell , smart battery													
Battery - type	<i>6-cell:</i> up to 3.5 hr; <i>optional 9-cell:</i> up to 4.9 hr													
Battery - life ¹⁰	<p>Mobile Intel GM965 Express Chipset (Graphics Memory Controller Hub); ICH8M I/O Controller Hub (SATA 3.0Gb/s, ATA-100 EIDE, USB 2.0, PCI Express® 1.1, PCI 2.3), LPC bus (ENE KB925 Super I/O) One slot (ExpressCard/34, ExpressCard/54) 5-in-1 reader (MultiMedia Card, Memory Stick®, Memory Stick PROTM, Secure Digital, xD-Picture CardTM)</p>													
ExpressCard/54	Four USB 2.0, external monitor (VGA DB-15), modem (RJ-11), ethernet (RJ-45), S-video out port (TV out; one 7-pin industry standard connector), IEEE 1394 FireWire 400 (4-pin connector; 1394a-2000 standard)													
Multicard Reader	<p>One Mini PCI Express slot, not customer upgradable Some: 11b/g wireless⁴, Lenovo 11b/g Mini PCI Express Adapter, Broadcom® chipset Some: 11a/b/g wireless⁴, Mini PCI Express adapter, Intel PRO/Wireless 3945ABG Some: 11a/b/g/n wireless⁴, Mini PCIe adapter, Intel Wireless WiFi Link 4965AGN, MIMO 2x3 (Kedron)</p>													
Ports	Some: Bluetooth 2.0 wireless, USB 2.0 interface via ICH8M, LED indicator													
Mini PCI Express	56K V.92 ⁶ modem, not customer accessible													
Lenovo 11b/g ¹¹	10/100 ethernet, Broadcom® BCM5906M, PCI 2.3													
Intel 11a/b/g ¹¹	Intel High Definition (HD) Audio, RealTek® ALC861VD codec / stereo speakers, 1.5 watt / volume, up, down, mute button / stereo microphone, microphone input jack (3.5 mm), headphone jack (3.5 mm)													
Intel 11n ²⁸	Power-on password, hard disk password, supervisor password, security keyhole													
Bluetooth TM	Some: Fingerprint reader on palm rest , swipe sensor, no preboot support													
Modem	<p>1-year - EasyServ^{TM,19} depot repair service / service upgrades²² available</p>													
Ethernet	<p>1GB PC2-5300 DDR2 SODIMM (TopSeller) 43R1999 2GB PC2-5300 DDR2 SODIMM (TopSeller) 43R2000 120GB Disk SATA 1.5Gb/s (5400 rpm) 41N5693 USB 2.0 Essential Memory Key 8GB 45J7905 USB 2.0 Super Multi-Burner Drive 41N5565 USB 2.0 Lenovo Enhanced Port Replicator 43R8770 Lenovo Laser Mouse (USB, PS/2) 41U3074 ExpressCard Gemplus Smart Card Readr 41N3043 Other accessories on O-N200 sheet</p>													
Audio support	<p>Lenovo C200/N200 15W Battery 6-cell 40Y8322 Lenovo N200 15W Li-Ion Battery 9-cell 41U5027 ThinkPad® and Lenovo 65W AC Adapter 40Y7696 90W Slim AC/DC Combo Adapter 41N8460 ThinkVision® L2240p Wide 22" Monitor 4422HB6 ThinkVision L2440p Wide 24" Monitor 4420HB2 Lenovo Carrying Case - Messenger Max 41U5253 Lenovo Case - Performance Backpack 41U5254 Others at http://lenovo.com/accessories</p>													
Security	<p>Lenovo CareSM 1-year LOR 9x5 NBD 41K0547 Lenovo Care 2-year LOR 9x5 NBD 41K0548 Lenovo Care 2-year P&L PU Depot 41K0545 Lenovo Care 3-year LOR 9x5 NBD 41K0549 Lenovo Care 3-year P&L PU Depot 41K0546</p>													
Fingerprint reader	<p>65-watt AC adapter (GMA X3100 graphics models) Wireless on/off switch RoHS-compliant International Warranty Service¹⁷ 24 hour x 7 day¹⁸ toll-free support during the warranty period¹² via 800-426-7378</p>													
Limited warranty ¹²														

See footnotes for important warranty information

Ⓢ US model announced June 24, 2008; previous models on Oct 2, Dec 4, 2007, Apr 8, or May 6, 2008

✕ US models withdrawn effective December 2007

Partial list of accessories supported on:

- **Lenovo 3000 N200 14W originally announced on May 22, 2007**
- **Lenovo 3000 N200 15W originally announced on May 9, 2007**

Memory

1GB PC2-5300 DDR2 SODIMM (TopSeller)	43R1999	ann 03/25/08
2GB PC2-5300 DDR2 SODIMM (TopSeller)	43R2000	ann 03/25/08

Storage and removable storage

USB 2.0 Essential Memory Key 1GB	41U4940	ann 01/23/07
USB 2.0 Essential Memory Key 2GB	41U4944	ann 01/23/07
USB 2.0 Essential Memory Key 4GB	45J7904	ann 06/24/08
USB 2.0 Essential Memory Key 8GB	45J7905	ann 07/15/08
USB 2.0 Essential Memory Key 32GB	45K1258	ann 10/28/08
USB 2.0 Security Memory Key 1GB	41U5118	ann 07/17/07
USB 2.0 Security Memory Key 2GB	41U5119	ann 07/17/07
USB 2.0 Security Memory Key 4GB	41U5120	ann 07/17/07
USB 2.0 Ultra Secure Memory Key 1GB	45J5915	ann 08/26/08
USB 2.0 Ultra Secure Memory Key 2GB	45J5916	ann 08/26/08
USB 2.0 Ultra Secure Memory Key 4GB	45J5917	ann 08/26/08
USB 2.0 Ultra Secure Memory Key 8GB	45J5918	ann 08/26/08
USB 2.0 Super Multi-Burner Drive	41N5565	ann 01/23/07
120GB Disk 9.5mm SATA 1.5Gb/s (5400 rpm)	41N5693	ann 03/20/07

Expansion

USB 2.0 Lenovo Enhanced Port Replicator	43R8770	ann 02/26/08
ThinkPad Adjustable Notebook Stand	40Y7676	ann 09/20/05

Keyboard

USB Numeric Keypad	33L3225	ann 05/01/00
Preferred Pro USB Keyboard	73P5220	ann 06/21/05
Enhanced Performance USB Keyboard	73P2620	ann 03/23/04
Wireless Kybd & Opt Wheel Mouse (via USB)	73P4067	ann 12/07/04
USB Keyboard with UltraNav	31P8950	ann 01/28/03
USB Travel Keyboard with UltraNav	31P9490	ann 04/27/04

Mouse

Optical Wheel Mouse (USB)	06P4069	ann 05/21/03
Optical ScrollPoint® Mouse (USB, PS/2)	31P7405	ann 08/27/02
Optical Wheel Travel Mouse (USB, PS/2)	31P7410	ann 06/04/02
Laser Tilt Wheel Mouse (USB, PS/2)	41U3074	ann 01/23/07
Lenovo Wireless Laser Mouse (blk, via USB)	45K1696	ann 11/25/08
Lenovo Wireless Laser Mouse (red, via USB)	51J0198	ann 11/25/08
Laser Tilt Wheel Travel Mouse (Bluetooth)	41U5008	ann 01/22/08
Wireless Kybd & Opt Wheel Mouse (via USB)	73P4067	ann 12/07/04

Security

Kensington® Cable Lock from Lenovo	73P2582	ann 12/29/03
Kensington Twin Head Cable Lock	45K1620	ann 09/30/08
USB Gemplus GemPC Smart Card Reader	41N3040	ann 02/21/06
<i>ExpressCard/54 slot:</i>		
ExpressCard Gemplus Smart Card Reader	41N3043	ann 06/27/06

Multimedia

USB 2.0 Lenovo Multimedia Headset	40Y8518	ann 06/27/06
USB 2.0 Lenovo Webcam	40Y8519	ann 08/29/06

Power Accessories

N200 14W (0687) only:

Lenovo N200 14W Li-Ion Battery 6-cell	41U5025	ann 05/22/07
Lenovo N200 14W Li-Ion Battery 9-cell	41U5026	ann 05/22/07

N200 15W (0769) only:

Lenovo C200/N200 15W Li-Ion Battery 6-cell	40Y8322	ann 10/17/06
Lenovo N200 15W Li-Ion Battery 9-cell	41U5027	ann 05/09/07

All models:

ThinkPad and Lenovo 65W AC Adapter ⁴⁵	40Y7696	ann 09/20/05
⁴⁵ Only compatible with the 945GM and GM965 chipset models.		
ThinkPad and Lenovo 90W AC Adapter	40Y7659	ann 09/20/05
Lenovo 90W Slim AC/DC Combo Adapter	41N8460	ann 11/27/07
Belkin Surge Protector	31P7659	
Belkin 1 outlet Notebook Surge	31P7658	

Carrying Cases

Lenovo Carrying Case - Messenger Max	41U5253	ann 05/01/07
Lenovo Carry Case - Performance Backpack	41U5254	ann 05/01/07
Lenovo Standard Case	45K1697	ann 11/25/08
Lenovo Standard Backpack	45K1698	ann 11/25/08

Monitors

ThinkVision® L174 17" Monitor	9227AE1	ann 04/15/08
ThinkVision L1700p 17" Monitor	9417HE2	ann 09/17/08
ThinkVision L1900p 19" Monitor	4431HE1	ann 11/11/08
ThinkVision L1940p Wide 19" Monitor	4424HB6	ann 09/17/08
ThinkVision L200p Wide 20.1" Monitor	4438HB6	ann 04/15/08
ThinkVision L2240p Wide 22" Monitor	4422HB6	ann 09/17/08
ThinkVision L2440p Wide 24" Monitor	4420HB2	ann 09/17/08
ThinkVision L2440x Wide 24" Monitor	4421HB2	ann 09/17/08

Monitor Accessories⁴⁶

ThinkVision USB Soundbar	40Y7616	ann 08/23/05
ThinkVision Soundbar	45K1263	ann 09/16/08
Kensington Cable Lock from Lenovo	73P2582	ann 12/29/03
Kensington Twin Head Cable Lock	45K1620	ann 09/30/08
ThinkPad Convertible Monitor Stand	40Y7620	ann 01/05/06
Radial Arm	19K4464	ann 05/05/00

⁴⁶ Compatible on selected Lenovo and ThinkVision monitors.

More information at www.lenovo.com/support/monitoraccessories

Other accessories at www.lenovo.com/accessories

Accessories Guide pdf at www.lenovo.com/accessoriesguide

Lenovo CareSM maintenance services

Warranty service upgrade:²²

1-year Lenovo Onsite Repair (LOR) 9x5 Next Business Day	41K0547
2-year Lenovo Onsite Repair (LOR) 9x5 Next Business Day	41K0548
2-year Parts and Labor (P&L) Pickup Depot	41K0545
3-year Lenovo Onsite Repair (LOR) 9x5 Next Business Day	41K0549
3-year Parts and Labor (P&L) Pickup Depot	41K0546

Post-warranty maintenance services:⁵

1-year maintenance Parts and Labor Pickup Depot SBD	41K0550
1-year maintenance 9x5 Next Business Day response	41K0551
2-year maintenance Parts and Labor Pickup Depot SBD	41K0552
2-year maintenance 9x5 Next Business Day response	41K0553

[SBD=Second Business Day average response]

Lenovo Care maintenance services at www.lenovo.com/warranty

lenovo



Lenovo 3000 N500



Lenovo 3000 N500



Lenovo 3000 N500



Lenovo 3000 N500

Lenovo® 3000 N500 15W (4233)

Personal Systems Reference (PSREF)

Type-model	Processor	GHz	Memory	Wide-screen display	Screen type	Camera	Integrated graphics	Disk SATA GB ⁸ rpm	SATA optical	Mini PCIe 802.11 wireless	Mini PCIe WWAN	Mini PCIe UWB or Turbo	Blue/ Fing	Battery cells	Vista preload	Availability
4233-52U	Cel 575	2.00	1GB	15.4"	WXGA	Glossy	Cam	GMA 160G 5400	DVD±RW	Lenovo 11b/g ¹¹	None	None	No	6	Home B	Nov 08
✕ 4233-53U	T3200	2.00	1GB	15.4"	WXGA	Glossy	Cam	GMA 160G 5400	DVD±RW	Lenovo 11b/g	None	None	No	6	Bus 32	Nov 08
4233-54U	T3400	2.16	2GB	15.4"	WXGA	Glossy	Cam	GMA 250G 5400	DVD±RW	Lenovo 11b/g	None	None	No	6	Bus 32	Nov 08
✕ 4233-62U	T3200	2.00	1GB	15.4"	WXGA	Glossy	Cam	GMA 160G 5400	DVD±RW	Lenovo 11b/g	None	None	No	6	XP Pro	Nov 08
4233-63U	T3400	2.16	2GB	15.4"	WXGA	Glossy	Cam	GMA 250G 5400	DVD±RW	Lenovo 11b/g	None	None	No	6	XP Pro	Nov 08
☞ 4233-6BU	T3400	2.16	1GB	15.4"	WXGA	Glossy	Cam	GMA 160G 5400	DVD±RW	Lenovo 11b/g	None	None	No	6	XP Pro	Jan 09

• **These Lenovo 3000 N500 models use a 15.4" widescreen display**

Processor	Intel® Celeron® Processor 575 with single-core, 667MHz system bus, and 1MB L2 cache or Intel Pentium® processor T3200 or T3400 with dual-core, 667MHz system bus, and 1MB L2 cache										Preloaded operating system²⁰ - Some: Microsoft Windows® XP Professional with Vista® COA - Some: Microsoft Windows Vista Home Basic Edition (32-bit) - Some: Microsoft Windows Vista Business Edition (32-bit) ✦ Vista Basic logo					
Memory	1GB or 2GB std / 4GB max ⁷ / PC2-5300 667MHz DDR2, non-parity, dual-channel capable, two 200-pin SO-DIMM sockets; <i>Non-italics:</i> standard memory in one socket; one socket available										Preloaded applications¹⁴ • Lenovo Care™ Tools • Rescue and Recovery™ • Access Connections™ • System Update • Norton Internet Security™ (90 days of virus definitions) • PC-Doctor™ (diagnostics) • ThinkPad Utilities (Power Manager and Presentation Director) • Adobe® Reader • Windows Live™ Toolbar • Windows Live Search • Microsoft Office 2007 Trial (60-day) • Roxio® Creator® Small Business Edition • Corel WinDVD® (DVD±RW)					
SATA DVD±RW SATA disk	DVD burner, SATA 1.5Gb/s, 12.7mm high, fixed, not removable, tray-in 160GB⁸ (5400 rpm) or 250GB (5400 rpm) / SATA 1.5Gb/s, 9.5mm high, removable, upgradable															
Widescreen display	15.4" (391.2mm) WXGA (1280x800) color, VibrantView (glossy), CCFL backlight, 185 nits, 16:10 aspect ratio, 400:1 contrast ratio															
Camera	Camera on top of screen, 1.3-megapixel, fixed focus															
Integrated graphics	Intel Graphics Media Accelerator 4500M (GMA 4500M) , in GL40, HDMI port supporting HDCP to output protected content <i>Max external resolution:</i> 2048x1536@75Hz (DB-15 port); 1920x1080 (HDMI port)															
Keyboard	Full-size keyboard, 6-row, Lenovo Care button, multimedia Fn keys, Windows/Appl keys															
Touch controls	Touch-sensitive audio control panel (Mute, vol up, vol down, enable/disable touchpad)															
Touch pad	Two-button touch pad with scroll feature (no TrackPoint®)															
Dimensions ³	6-cell 15.4W" (WxDxH): 14.1" x 10.1" x 1.22–1.46"; 358.5 x 256.5mm x 31–37mm															
Weight ²	6-cell: starting at 5.95 lb (2.7kg)															
Case color	Silver top cover; black bottom															
Case material	Scratch-resistant ABS plastic															
Battery - type	Lithium Ion 6-cell															
Battery - life ¹⁰	6-cell: up to 3.8 hr															
Chipset	Mobile Intel GL40 Express Chipset (Graphics Memory Controller Hub), ICH9M I/O Controller Hub (SATA 3.0Gb/s, USB 2.0, PCI Express® 1.1, PCI 2.3, security chip, ethernet MAC)															
ExpressCard/54	One slot (ExpressCard/34, ExpressCard/54)															
Multicard reader	4-in-1 reader (Memory Stick, Memory Stick PRO™, Secure Digital, xD-Picture Card™)															
PC Card	None															
Smart Card read	None															
Ports	Four USB 2.0, external monitor (VGA DB-15, HDMI), modem (RJ-11), ethernet (RJ-45)															
Mini PCI Express	One Mini PCI Express slot															
Lenovo 11b/g ¹¹	11b/g wireless ⁴ , Lenovo 11b/g Mini PCI Express Adapter, Broadcom® chipset															
WWAN upg	None															
2G Turbo	None															
UWB	None															
Modem	56K V.92 ⁶ modem															
Bluetooth™	None															
Ethernet	10/100 ethernet, Broadcom® BCM5906M															
Intel AMT	None															
Audio support	High Definition (HD) Audio, CX20561-15Z codec / stereo speakers, 2 watt / volume up, down, mute buttons / microphone, mic input jack, headphone jack															
Security	Power-on password, hard disk password, supervisor password, security keyhole															
Security chip	None															
Fingerprint reader	None															
Limited warranty ¹²	1-year - EasyServ™.19 depot repair service / service upgrades ²² available															
1GB PC2-5300 DDR2 SODIMM (TopSeller)	43R1999			N500 Series Li-Ion Battery 6-cell			51J0226			Lenovo Care 3-year LOR 9x5 NBD						
2GB PC2-5300 DDR2 SODIMM (TopSeller)	43R2000			Lenovo 90W AC Adapter			41R4322			Lenovo Care 3-year P&L PU Depot						
USB 2.0 Essential Memory Key 4GB	45J7904			Business Topload Case			43R2476			41K0547						
USB 2.0 Essential Memory Key 32GB	45K1258			Deluxe Expander Case			43R2478			41K0548						
USB 2.0 Lenovo Webcam	40Y8519			ThinkVision® L2240p Wide 22" Monitor			4422HB6			41K0549						
USB 2.0 Lenovo Enhanced Port Replicator	43R8770			ThinkVision L2440x Wide 24" Monitor			4421HB2			41K0546						
Laser Tilt Wheel Travel Mouse (Bluetooth)	41U5008			Other accessories at lenovo.com/accessories												

See footnotes for important warranty information

☞ US model announced January 6, 2009; previous models on November 11 or November 25, 2008

✕ US models withdrawn effective January 2009

© Lenovo
(DOV1-1) January 2009

Type-model	Processor	GHz	Memory	Widescreen display	Screen type	Camera	Integrated graphics	SATA disk	EIDE optical	Mini PCIe 802.11 wireless	Finger-print reader	Battery cells	Preload	Avail date	
✕ 0764-2BU	Core 2 Duo T7100	1.80	1GB	12.1" WXGA	Glossy	Cam	GMA	160GB	DVD±RW	*Intel 11a/b/g ¹¹	Blue	Fing	3	Home Prem	May 07
✕ 0764-2CU	Core 2 Duo T7300	2.00	1GB	12.1" WXGA	Glossy	Cam	GMA	160GB	DVD±RW	*Intel 11a/b/g	Blue	Fing	6	Business 32	May 07
✕ 0764-2DU	Core 2 Duo T7300	2.00	2GB	12.1" WXGA	Glossy	Cam	GMA	160GB	DVD±RW	*Intel 11n ²⁸	Blue	Fing	6	Ultimate 32	May 07
✕ 0764-2NU	Core 2 Duo T5250	1.50	2GB	12.1" WXGA	Glossy	Cam	GMA	160GB	DVD±RW	*Intel 11n	Blue	Fing	6	Ultimate 32	July 07
✕ 0764-2PU	Core 2 Duo T5250	1.50	1GB	12.1" WXGA	Glossy	Cam	GMA	160GB	DVD±RW	*Intel 11a/b/g	Blue	Fing	6	XP Pro	Oct 07
0764-2WU	Core 2 Duo T5550	1.83	1GB	12.1" WXGA	Glossy	Cam	GMA	160GB	DVD±RW	*Intel 11a/b/g	Blue	Fing	3	XP Pro	Jan 08
0764-2XU	Core 2 Duo T5550	1.83	2GB	12.1" WXGA	Glossy	Cam	GMA	160GB	DVD±RW	*Intel 11n	Blue	Fing	6	Business 32	Jan 08
☞ 0764-2YU	Core 2 Duo T5750	2.00	1GB	12.1" WXGA	Glossy	Cam	GMA	160GB	DVD±RW	*Intel 11a/b/g	Blue	Fing	3	Business 32	Mar 08

• These models use a 12.1" widescreen display
 • Two-spindle (disk and optical) in an ultraportable
 • Multimedia ready: press button to load InterVideo InstantON music and movie player without loading OS

Positioning	Widescreen ultraportable; two spindles	Preloaded operating system²⁰ - Some: Microsoft® Windows® XP Professional with Vista® COA - Some: Microsoft Windows Vista Home Premium Ed (32-bit) - Some: Microsoft Windows Vista Business Edition (32-bit) - Some: Microsoft Windows Vista Ultimate Edition (32-bit) ✧ 2YU model: Vista Basic logo ✧ Other Vista models: Vista Premium logo Preloaded applications¹⁴ (all OSes) • Lenovo Care SM Tools – Rescue and Recovery™ – System Update – Password Manager – Access Connections™ • Lenovo Multimedia Center (Vista) • Norton Internet Security™ (90 days of virus definitions) • Softex OmniPass (on fingerprint models) • PC-Doctor™ (diagnostics) • Network Magic™ • Windows Live™ Toolbar • Windows Live Search • Adobe® Reader • Picasa from Google • Diskeeper® Home • Corel® Small Business Center™ with WordPerfect® Office 12 • QuickBooks Financial Center • Microsoft Office 2007 Trial • EarthLink (Vista Home Basic and Home Premium models only) • InterVideo InstantON • Roxio Digital Media LE (DVD±RW for XP only) • Corel WinDVD® (DVD±RW for XP only) • Corel WinDVD Creator (DVD±RW for XP only) Universal 65-watt AC adapter Wireless on/off switch RoHS-compliant ENERGY STAR® 4.0-compliant International Warranty Service ¹⁷ 24 hour x 7 day ¹⁸ toll-free support during the warranty period ¹² via 800-426-7378
Processor	Intel® Core™ 2 Duo processor T5250, T5550, or T5750 with dual-core, Intel 64 Technology, Enhanced Intel SpeedStep® technology ¹ , Execute Disable Bit, 667MHz system bus, and 2MB shared L2 cache or Intel Core 2 Duo processor T7100 or T7300 with dual-core, Intel 64 Technology, Enhanced Intel SpeedStep technology ¹ , Intel Dynamic Acceleration, Execute Disable Bit, Virtualization Technology, and 800MHz system bus; T7100: 2MB L2 cache (shared); T7300: 4MB L2 cache (shared)	
Memory	1GB or 2GB std / 4GB max ⁷ / PC2-5300 667MHz DDR2, non-parity, dual-channel capable, two 200-pin SO-DIMM sockets; <i>Italics:</i> standard memory in both sockets; no sockets available; <i>Non-italics:</i> standard memory in one socket; one socket available	
Diskette drive	None (use optional USB-based diskette drive)	
EIDE DVD±RW SATA disk	DVD burner, DL support, fixed, not removable, 12.7mm high 160GB ⁸ (5400 rpm) / SATA 1.5Gb/s, 9.5mm high, removable and upgradable	
Widescreen display	12.1" (307.3mm) WXGA (1280x800) TFT color, VibrantView (glossy), CCFL backlight, 180 nits, 16:9 aspect ratio, 400:1 contrast ratio, no latch open-close mechanism	
Camera	Camera on top of screen, 1.3-megapixel, fixed focus, internal USB 2.0	
Graphics	Intel Graphics Media Accelerator X3100, in GM965	
Keyboard	Full-size keyboard, 6-row, 84-key, multimedia Fn keys; Buttons across top: on-off, Lenovo Care SM , instant on, mute, volume down, volume up	
Touch pad InstantON	Two-button touch pad with scroll feature (no TrackPoint®) Press button to load InterVideo InstantON music and movie player without loading OS	
Dimensions ³	3-cell (WxDxH): 12.01" x 8.94" x 1.25"; 305.1mm x 227.0mm x 31.7mm 6-cell (WxDxH): 12.01" x 9.68" x 1.25"; 305.1mm x 246.0mm x 31.7mm	
Weight ²	with optical drive and battery: 4.0 lb (1.81kg) to 4.4 lb (1.99kg)	
Case color	Silver top; black bottom	
Case material	ABS plastic	
Battery - type	Lithium Ion 3-cell or 6-cell, 2600 mAh, smart battery	
Battery - life ¹⁰	3-cell: up to 2.1 hr; 6 cell: up to 4.2 hr	
Chipset	Mobile Intel GM965 Express Chipset (Graphics Memory Controller Hub); ICH8M I/O Controller Hub (SATA 3.0Gb/s, ATA-100 EIDE, USB 2.0, PCI Express® 1.1, PCI 2.3), LPC bus (ENE KB925 Super I/O)	
ExpressCard/54 Multicard reader	One slot (ExpressCard/34, ExpressCard/54) 5-in-1 reader (MultiMedia Card, Memory Stick®, Memory Stick PRO™, Secure Digital, xD-Picture Card™)	
Ports	Three USB 2.0, external monitor (VGA DB-15), modem (RJ-11), ethernet (RJ-45), IEEE 1394 FireWire 400 (4-pin connector; 1394a-2000 standard)	
Mini PCI Express	One Mini PCI Express slot, not customer upgradable Some: 11a/b/g wireless ⁴ , Mini PCI Express adapter, Intel PRO/Wireless 3945ABG Some: 11a/b/g/n wireless ⁴ , Mini PCI Express adapter, Intel Wireless WiFi Link 4965AGN, MIMO 2x3 (Kedron)	
Bluetooth™	Bluetooth 2.0 wireless, USB 2.0 interface via ICH8M, LED indicator	
Modem	56K V.92 ⁶ modem	
Ethernet	10/100 ethernet, Broadcom® BCM5906M, PCI Express x1	
Audio support	Intel High Definition (HD) Audio, Conexant® CX20549 codec / stereo speakers, 1 watt / volume, up, down, mute button / stereo microphone, microphone input jack (3.5 mm), headphone jack (3.5 mm)	
Security	Power-on password, hard disk password, supervisor password, security keyhole	
Fingerprint reader	Fingerprint reader on palm rest, swipe sensor, no preboot support	
Limited warranty ¹²	1-year - EasyServ™ ¹⁹ depot repair service / service upgrades ²² available	

1GB PC2-5300 DDR2 SODIMM (TopSeller)	43R1999	V100 Series Li-Ion Battery 3-cell	40Y8319	Lenovo Care SM 1-year LOR 9x5 NBD
2GB PC2-5300 DDR2 SODIMM (TopSeller)	43R2000	V100 Series Li-Ion Battery 6-cell	40Y8321	41K0547
USB Portable Diskette Drive	05K9276	ThinkPad and Lenovo 65W AC Adapter	40Y7696	Lenovo Care 2-year LOR 9x5 NBD
USB 2.0 Lenovo Multimedia Headset	40Y8518	ThinkPad and Lenovo 90W AC Adapter	40Y7659	41K0548
USB 2.0 Essential Memory Key 8GB	45J7905	90W Slim AC/DC Combo Adapter	41N8460	Lenovo Care 2-year P&L PU Depot
USB 2.0 Lenovo Enhanced Port Replicator	43R8770	Lenovo Carrying Case - Messenger Max	41U5253	41K0545
USB 2.0 Super Multi-Burner Drive	41N5565	Lenovo Case - Performance Backpack	41U5254	Lenovo Care 3-year LOR 9x5 NBD
160GB Disk 9.5mm SATA 1.5Gb/s (5400 rpm)	41N5692	ThinkVision® L2240p Wide 22" Monitor	4422HB6	41K0549
Laser Tilt Wheel Mouse (USB, PS/2)	41U3074	ThinkVision L2440x Wide 24" Monitor	4421HB2	Lenovo Care 3-year P&L PU Depot
Kensington® MicroSaver® Security Cable	73P2582	Others at http://lenovo.com/accessories		41K0546

See footnotes for important warranty information

* Intel Centrino® processor technology

© Lenovo

☞ US model announced March 18, 2008; previous models on May 22, July 17, October 2, 2007, or January 8, 2008

(FS2-1) March 2008

✕ US models withdrawn effective December 2007 or May 2008

Partial list of accessories supported on:
• Lenovo 3000 V200 announced on May 22, 2007

Memory

1GB PC2-5300 DDR2 SODIMM (TopSeller)	43R1999	ann 03/25/08
2GB PC2-5300 DDR2 SODIMM (TopSeller)	43R2000	ann 03/25/08

Storage and removable storage

USB 2.0 Essential Memory Key 1GB	41U4940	ann 01/23/07
USB 2.0 Essential Memory Key 2GB	41U4944	ann 01/23/07
USB 2.0 Essential Memory Key 4GB	45J7904	ann 06/24/08
USB 2.0 Essential Memory Key 8GB	45J7905	ann 07/15/08
USB 2.0 Essential Memory Key 32GB	45K1258	ann 10/28/08
USB 2.0 Security Memory Key 1GB	41U5118	ann 07/17/07
USB 2.0 Security Memory Key 2GB	41U5119	ann 07/17/07
USB 2.0 Security Memory Key 4GB	41U5120	ann 07/17/07
USB 2.0 Ultra Secure Memory Key 1GB	45J5915	ann 08/26/08
USB 2.0 Ultra Secure Memory Key 2GB	45J5916	ann 08/26/08
USB 2.0 Ultra Secure Memory Key 4GB	45J5917	ann 08/26/08
USB 2.0 Ultra Secure Memory Key 8GB	45J5918	ann 08/26/08
USB Portable Diskette Drive	05K9276	ann 06/05/00
USB 2.0 CD-RW/DVD-ROM Combo II Drive	40Y8637	ann 01/05/06
USB 2.0 Portable 160GB Hard Disk	43R1784	ann 09/23/08
USB 2.0 Portable Secure 160GB Hard Disk	43R2018	ann 11/18/08
USB 2.0 Portable Secure 320GB Hard Disk	43R2019	ann 11/18/08
USB 2.0 Super Multi-Burner Drive	41N5565	ann 01/23/07
160GB Disk 9.5mm SATA 1.5Gb/s (5400 rpm)	41N5692	ann 03/20/07

Expansion

USB 2.0 Lenovo Enhanced Port Replicator	43R8770	ann 02/26/08
ThinkPad Adjustable Notebook Stand	40Y7676	ann 09/20/05

Keyboard

USB Numeric Keypad	33L3225	ann 05/01/00
Preferred Pro USB Keyboard	73P5220	ann 06/21/05
Enhanced Performance USB Keyboard	73P2620	ann 03/23/04
Wireless Kybd & Opt Wheel Mouse (via USB)	73P4067	ann 12/07/04
USB Keyboard with UltraNav	31P8950	ann 01/28/03
USB Travel Keyboard with UltraNav	31P9490	ann 04/27/04

Mouse

Optical Wheel Mouse (USB)	06P4069	ann 05/21/03
Optical ScrollPoint® Mouse (USB, PS/2)	31P7405	ann 08/27/02
Optical Wheel Travel Mouse (USB, PS/2)	31P7410	ann 06/04/02
Laser Tilt Wheel Mouse (USB, PS/2)	41U3074	ann 01/23/07
Lenovo Wireless Laser Mouse (blk, via USB)	45K1696	ann 11/25/08
Lenovo Wireless Laser Mouse (red, via USB)	51J0198	ann 11/25/08
Laser Tilt Wheel Travel Mouse (Bluetooth)	41U5008	ann 01/22/08
Wireless Kybd & Opt Wheel Mouse (via USB)	73P4067	ann 12/07/04

Security

Kensington® Cable Lock from Lenovo	73P2582	ann 12/29/03
Kensington Twin Head Cable Lock	45K1620	ann 09/30/08
USB Gemplus GemPC Smart Card Reader	41N3040	ann 02/21/06
<i>ExpressCard/54 slot:</i>		
ExpressCard Gemplus Smart Card Reader	41N3043	ann 06/27/06

Multimedia

USB 2.0 Lenovo Multimedia Headset	40Y8518	ann 06/27/06
USB 2.0 Lenovo Webcam	40Y8519	ann 08/29/06

Power Accessories

Lenovo V100 Series Li-Ion Battery 3-cell	40Y8319	ann 05/16/06
Lenovo V100 Series Li-Ion Battery 6-cell	40Y8321	ann 05/16/06
ThinkPad and Lenovo 65W AC Adapter	40Y7696	ann 09/20/05
ThinkPad and Lenovo 90W AC Adapter	40Y7659	ann 09/20/05
Lenovo 90W Slim AC/DC Combo Adapter	41N8460	ann 11/27/07
Belkin Surge Protector	31P7659	
Belkin 1 outlet Notebook Surge	31P7658	

Carrying Cases

Lenovo Carrying Case - Messenger Max	41U5253	ann 05/01/07
Lenovo Carry Case - Performance Backpack	41U5254	ann 05/01/07
Lenovo Standard Case	45K1697	ann 11/25/08
Lenovo Standard Backpack	45K1698	ann 11/25/08

Monitors

ThinkVision® L174 17" Monitor	9227AE1	ann 04/15/08
ThinkVision L1700p 17" Monitor	9417HE2	ann 09/17/08
ThinkVision L1900p 19" Monitor	4431HE1	ann 11/11/08
ThinkVision L1940p Wide 19" Monitor	4424HB6	ann 09/17/08
ThinkVision L200p Wide 20.1" Monitor	4438HB6	ann 04/15/08
ThinkVision L2240p Wide 22" Monitor	4422HB6	ann 09/17/08
ThinkVision L2440p Wide 24" Monitor	4420HB2	ann 09/17/08
ThinkVision L2440x Wide 24" Monitor	4421HB2	ann 09/17/08

Monitor Accessories⁴⁶

ThinkVision USB Soundbar	40Y7616	ann 08/23/05
ThinkVision Soundbar	45K1263	ann 09/16/08
Kensington Cable Lock from Lenovo	73P2582	ann 12/29/03
Kensington Twin Head Cable Lock	45K1620	ann 09/30/08
ThinkPad Convertible Monitor Stand	40Y7620	ann 01/05/06
Radial Arm	19K4464	ann 05/05/00

⁴⁶ Compatible on selected Lenovo and ThinkVision monitors.

More information at www.lenovo.com/support/monitoraccessories

Medialess License Key (MLK)

Microsoft® Office 2007 Basic, English	43R1528	ann 01/31/07
Microsoft Office 2007 Small Business, Engl	43R1534	ann 01/31/07
Microsoft Office 2007 Professional, English	43R1531	ann 01/31/07

Other accessories at www.lenovo.com/accessories

Accessories Guide pdf at www.lenovo.com/accessoriesguide

Lenovo CareSM maintenance services

Warranty service upgrade:²²

1-year Lenovo Onsite Repair (LOR) 9x5 Next Business Day	41K0547
2-year Lenovo Onsite Repair (LOR) 9x5 Next Business Day	41K0548
2-year Parts and Labor (P&L) Pickup Depot	41K0545
3-year Lenovo Onsite Repair (LOR) 9x5 Next Business Day	41K0549
3-year Parts and Labor (P&L) Pickup Depot	41K0546

Post-warranty maintenance services:⁵

1-year maintenance Parts and Labor Pickup Depot SBD	41K0550
1-year maintenance 9x5 Next Business Day response	41K0551
2-year maintenance Parts and Labor Pickup Depot SBD	41K0552
2-year maintenance 9x5 Next Business Day response	41K0553

[SBD=Second Business Day average response]

Lenovo Care maintenance services at www.lenovo.com/warranty

Part number	Processor	GHz	Memory	Widescreen display	Camera	Integrated graphics	SATA disk	EIDE optical	Mini PCIe 802.11 wireless	Finger-print reader	Chip-set	Vista preload	Avail date
59-011896	Pentium T2310	1.46	1GB	14.1" WXGA	Cam	GMA	160G ⁸	DVD±RW	Intel 11a/b/g ¹¹	None	None	GM Home Prem	Oct 07
59-011843	Core 2 Duo T5250	1.50	2GB	14.1" WXGA	Cam	GMA	160G	DVD±RW	*Intel 11a/b/g	None	None	GM Home Prem	Oct 07
59-011897	Core 2 Duo T5450	1.66	2GB	14.1" WXGA	Cam	GMA	160G	DVD±RW	*Intel 11a/b/g	None	None	GM Home Prem	Oct 07
<ul style="list-style-type: none"> • 14.1" widescreen display • Dolby Home Theater premium audio system with subwoofer • Audio DJ plays CDs without booting the system • Shuttle Center offers a one-stop, total entertainment environment with Shuttle Key that puts volume and equalizer controls on the keyboard 													
Positioning Processor	<i>Widescreen flexibility; two-spindle</i> Intel® Pentium® Dual-Core Processor T2310 with dual-core, Enhanced Intel SpeedStep® technology ¹ , Execute Disable Bit, 533MHz system bus, and 1MB shared L2 cache or Intel Core™ 2 Duo processor T5250 or T5450 with dual-core, Intel 64 Technology, Enhanced Intel SpeedStep technology ¹ , Execute Disable Bit, 667MHz system bus, and 2MB shared L2 cache										Preloaded operating system²⁰ - Microsoft® Windows® Vista™ Home Premium Edition (32-bit) ⇨ Vista Premium logo Preloaded applications¹⁴ • OneKey Recovery • Norton Internet Security™ (90 days of virus definitions) • Power 2Go (DVD±RW) • Adobe® Reader • Windows Live™ Toolbar • Picasa from Google • Shuttle Center (DVD±RW) • EasyCapture • Microsoft Office 2007 Trial (60-day) • VeriFace • Earth Link • Lenovo AnyComm		
Memory	1GB or 2GB std / 4GB max ⁷ / PC2-5300 667MHz DDR2 , non-parity, dual-channel capable, two 200-pin SO-DIMM sockets; <i>Italics:</i> standard memory in both sockets; no sockets available												
Diskette drive	None (use optional USB-based diskette drive)												
EIDE DVD±RW	DVD burner, dual-layer support, fixed, not removable, 12.7mm high												
SATA disk	160GB⁸ (5400 rpm) / SATA 1.5Gb/s, 9.5mm high, removable and upgradable												
Widescreen display	14.1" (358.1mm) WXGA (1280x800) TFT color, VibrantView (glossy), CCFL backlight, 185 nits, 16:10 aspect ratio, 400:1 contrast ratio												
Camera	Camera on top of screen, 1.3-megapixel, fixed focus, internal USB 2.0												
Graphics	Intel Graphics Media Accelerator X3100 , in GM965												
Keyboard	Full-size keyboard, 6-row, 84-key, multimedia Fn keys, Two-button touch pad with scroll feature (no TrackPoint®)												
Touch pad													
Dimensions ³	<i>(WxDxH):</i> 13.4" x 10.0" x 1.1" to 1.5"; 340mm x 253mm x 27 to 37mm												
Weight ²	with optical drive and battery: <i>6-cell:</i> 5.2 lb (2.4 kg)												
Case color	Silver top; silver bottom												
Case material	ABS plastic												
Battery - type	Lithium Ion 6-cell , smart battery												
Battery - life ¹⁰	Up to 3.5 hr												
Chipset	Mobile Intel GM965 Express Chipset (Graphics Memory Controller Hub); ICH8M I/O Controller Hub (SATA 3.0Gb/s, ATA-100 EIDE, USB 2.0, PCI Express® 1.1, PCI 2.3), LPC bus (ENE KB925 Super I/O)												
ExpressCard/54	One slot (ExpressCard/34, ExpressCard/54)												
Multicard reader	6-in-1 reader (MultiMedia Card, Memory Stick®, Memory Stick PRO™, Secure Digital Card, Secure Digital Elite Pro Card, xD-Picture Card™)												
Ports	Three USB 2.0, external monitor (VGA DB-15), S-video out port (TV-out), modem (RJ-11), ethernet (RJ-45), IEEE 1394 FireWire 400 (4-pin connector; 1394a-2000 standard)												
InstantON	Press button to support instant on CD play without loading OS												
Video out	S-video out port (TV-out), one 7-pin industry standard connector												
Mini PCI Express	One Mini PCI Express slot, not customer upgradable												
Intel 11a/b/g	11a/b/g wireless ⁴ , Mini PCI Express adapter, Intel PRO/Wireless 3945ABG												
Bluetooth™	None												
Modem	56K V.92 ⁶ modem, not customer accessible												
Ethernet	10/100 ethernet, Broadcom® BCM5906M, PCI 2.3												
Audio support	Intel High Definition (HD) Audio, RealTek® ALC262 codec / two stereo speakers, 2 watt, and subwoofer, 2 watt, Dolby Home Theater Technology / Audio DJ button, mute button / stereo microphone, microphone input jack (3.5 mm), stereo headphone jack (3.5 mm)												
Security	Power-on password, hard disk password, supervisor password, security lockhole												
Fingerprint reader	None												
Limited warranty ¹²	1-year - Depot Service ¹⁹ , onsite ¹³ pickup and delivery via 1-877-453-6686												
1GB PC2-5300 DDR2 SODIMM (TopSeller)	43R1999	Lenovo Y410 Battery 6-Cell		43R1955									
2GB PC2-5300 DDR2 SODIMM (TopSeller)	43R2000	Lenovo Y Series 90W AC Adapter		41R4322									
USB Portable Diskette Drive	05K9276	Lenovo 90W AC Adapter		45J7717									
USB 2.0 Essential Memory Key 4GB	45J7904	Lenovo Carrying Case - Messenger		41N5677									
USB 2.0 Essential Memory Key 8GB	45J7905	Lenovo Carrying Case - Messenger Max		41U5253									
USB 2.0 Security Memory Key 2GB	41U5119	Lenovo Case - Performance Backpack		41U5254									
USB 2.0 Security Memory Key 4GB	41U5120	ThinkVision® L1940p Wide 19" Monitor		4424HB6									
USB 2.0 Lenovo Multimedia Headset	41N5678	ThinkVision L2240p Wide 22" Monitor		4422HB6									
USB 2.0 Lenovo Webcam	41N5679	ThinkVision L2440x Wide 24" Monitor		4421HB2									
USB 2.0 Portable 160GB Hard Disk	43R1784	Kensington® Cable Lock from Lenovo		73P2582									
Enh Perf Wireless Keyboard and Mouse	41N5672	Others at http://lenovo.com/accessories											
										65-watt AC adapter (GMA X3100 graphics models) Wireless on/off switch RoHS-compliant ENERGY STAR® 4.0-compliant			

See footnotes for important warranty information
 US models announced October 9, 2007

* Intel Centrino® processor technology

Availability: All offers subject to availability. Lenovo reserves the right to alter product offerings and specifications at any time, without notice. Lenovo is not responsible for photographic or typographic errors.

Warranty: For a copy of applicable product warranties, write to: Warranty Information, P.O. Box 12195, RTP, NC, 27709, Attn: Dept ZPYA/B676. Lenovo makes no representation or warranty regarding third party products or services.

Footnotes:

- ¹ Power management, including Intel® SpeedStep® Technology, reduces processor speed when in battery mode.
- ² **Weight** includes battery and standard optical drive; weight may vary due to vendor components, manufacturing process and options.
- ³ **Thinness** may vary at certain points on the system.
- ⁴ **Wireless capability:** Requires compatible wireless-enabled options sold separately.
- ⁵ **Post-warranty annual maintenance agreement:** Service begins at the end of the base warranty or the end of any other applied warranty and maintenance option, whichever occurs last. Service delivery is not available the same day the maintenance agreement is purchased. Maintenance agreements must be purchased and the registration successfully completed prior to the service being available.
- ⁶ **Public network download modem speeds** are limited to 53Kbps. Upload speeds are limited to 48Kbps for V.92 modems. Actual speeds depend on many factors and are often less than the maximum possible. V.92 functions and speeds require compatible phone line and server equipment. Check with your telephone and ISP service providers for availability.
- ⁷ **Maximum memory capacity** may require the replacement of standard component with largest supported component available. On ThinkPad systems, even though it is possible to physically install 4GB of memory, the actual amount of memory addressable by a 32-bit operating system will be limited to 3GB. This limitation does not exist with 64-bit operating systems Windows XP Professional 64-bit and Windows Vista 64-bit Editions.
- ⁸ **Hard drive:** GB = billion bytes, TB = trillion bytes. Accessible capacity is less; up to 4GB is service partition.
- ¹⁰ **Battery:** These model numbers achieved Battery Rundown Time of at least the time shown during testing. A description of the testing available at lenovo.com/pc/ww/thinkpad/batterylife. Battery life (and recharge times) will vary based on many factors including screen brightness, applications, features, power management, battery conditioning, and other customer preferences.
- ¹¹ **Wireless:** Based on IEEE 802.11a, 802.11b, and 802.11g respectively. An adapter with 11a/b, 11b/g, or 11a/b/g can communicate on either/any of these listed formats respectively, the actual connection will be based on the access point to which it connects.
- ¹² **Limited warranty:** Support unrelated to a warranty issue may be subject to additional charges.
- ¹³ **Onsite Service:** If a machine is listed as having "On-site", this means that on-site service is available for the replacement of parts for warranty repairs. Certain parts, referred to as Customer Replaceable Unit ("CRU") parts, are easy to install and require little or no tools or technical knowledge. Some examples of CRU parts are mice, keyboards, hard disk drives, speakers, and memory. If your problem can be resolved with a CRU, the Support Center will offer to ship the part to you for you to install.
- ¹⁴ **Included software** may differ from its retail version (if available), and may not include user manuals or all program functionality. Software license agreements may apply.
- ¹⁵ **Modem speeds:** Public network download speeds are limited to 53Kbps. Upload speeds are limited to 48Kbps for V.92 modems. Actual speeds depend on many factors and are often less than the maximum possible. V.92 functions and speeds require compatible phone line and server equipment. Check with your telephone and ISP service providers for availability.
- ¹⁷ **International Warranty Service** is available for most products in any country in which this product is sold and serviced. Service delivery methods and parts availability vary by country, may be different from that in the country of purchase, and are subject to change without notice. Fees and restrictions may apply in some countries.
- ¹⁸ **Telephone support** may be subject to additional charges, even during the limited warranty period. Response times may vary and may exclude some holidays.
- ¹⁹ **EasyServ depot repair:** The customer may be asked certain diagnostic questions before a courier is sent. Your purchase includes this depot repair service, available in the U.S. during the limited warranty period.
- ²⁰ **Operating System:** Level of support varies by operating system. Operating systems not preloaded on the system may not provide full feature functionality. Refer to lenovo.com/pc/support and enter your machine type and model number for more information.
- ²¹ **For combination drives**, maximum possible speeds only are given in the following order: CD write, CD rewrite, CD read, DVD read.
- ²² **Lenovo Care Services:** These services are available for machines normally used for business, professional, or trade purposes, rather than personal, family, or household purposes. Not all machine types and models are covered. Service period begins with the equipment date of purchase. Service must be purchased during the original limited product warranty period. Service levels are response time objectives and are not guarantees. If the machine problem turns out to be a Customer Replaceable Unit (CRU), a part can be express shipped to you for quick replacement. For notebooks requiring LCD or other component replacement, Lenovo may choose to perform service at the depot repair center. Calls must be received by 5 pm local time in order to qualify for Next Business Day service. P&L means parts and labor. P/U means pick-up. See terms and conditions for complete details and restrictions.
- ²⁵ **Wireless WAN Cards:** Wireless data service requires separate agreement with Verizon Wireless. Verizon Wireless, not Lenovo, is solely responsible for service. Monthly and airtime charges may apply. Service may not be available in all areas; purchaser is responsible for verifying with Verizon Wireless that service is available for the intended location before the purchase of the card. For complete details, including service plans, additional required hardware or software, and service coverage, visit www.verizonwireless.com.

²⁸ **The IEEE 802.11n specification (MIMO)** has not been finalized and is currently in draft release. The Lenovo 11a/b/g/n (11n) Wireless LAN Mini PCI Express Adapters are based on the Draft Release, Version 1.0, of the IEEE 802.11n specification. The maximum speed depends on the access point device and the number of integrated antenna used for connection. An adapter with 11a/b, 11a/b/g, or 11a/b/g/n can communicate on any of its supported formats.

This publication was developed for products and services offered in the United States. Lenovo may not offer the products, services or features discussed in this document in other countries. Lenovo may withdraw an offering at any time. Information is subject to change without notice. Consult your local representative for information on offerings available in your area.

Lenovo reserves the right to change specifications or other product information without notice. Lenovo is not responsible for photographic or typographical errors. LENOVO PROVIDES THIS PUBLICATION "AS IS," WITHOUT WARRANTY OF ANY KIND, EITHER EXPRESS OR IMPLIED, INCLUDING THE IMPLIED WARRANTIES OF MERCHANTABILITY OR FITNESS FOR A PARTICULAR PURPOSE. Some jurisdictions do not allow disclaimer of express or implied warranties in certain transactions, therefore this disclaimer may not apply to you.



Trademarks: Lenovo, the Lenovo logo, New World. New Thinking., Access Connections, Rescue and Recovery, ThinkCentre, ThinkPad, ThinkStation, ThinkVantage, and ThinkVision are trademarks of Lenovo. Microsoft, Windows, and Vista are registered trademarks of Microsoft Corporation. Intel, the Intel logo, Intel Inside logo, Intel Core and Core Inside are trademarks of Intel Corporation in the US and other countries. Other company, product, or service names may be trademarks or service marks of others.

ENERGY STAR: As an ENERGY STAR Partner, Lenovo has determined that this product meets the ENERGY STAR guidelines for energy efficiency.

Visit www.lenovo.com/safecomputing periodically for the latest information on safe and effective computing.

Visit www.lenovo.com/psref for the latest version of Personal Systems Reference.

© Lenovo, 2009.
All rights reserved.

Lenovo
1009 Think Place
Morrisville, NC 27560
U.S.A.

January 2009
3book.pdf



Personal Systems Reference Lenovo® 3000 Desktops

January 2009 - Version 350



Visit www.lenovo.com/psref for the latest version

Part number	Slot x bay	Processor	GHz	L2 cache	Cores	Memory ⁸	Media reader	SATA disk	SATA optical	Graphics	Modem	Monitor	Camera	Vista preload	Avail date
57091128	1x4	Atom 230	1.60	512KB	1	1GB	16-in-1	160GB ²	DVD±RW	GMA 950	None	L195 HD	None	Home Basic	Jan 09

- **Lenovo Rescue System provides OneKey recovery and OneKey Antivirus without booting into Windows**

Processor	Intel® Atom™ Processor N230 with single-core, Hyper-Threading technology, Intel 64 Technology, Execute Disable Bit, 533MHz system bus, and 512KB L2 cache	Tower <ul style="list-style-type: none"> • Black bezel with glossy finish • 6.9" W X 16.1" D X 14.2" H • 175mm W X 409mm D X 360mm H • 20.1 lb (9.1 kg) in max configuration
Implementation	Processor in Micro-FCBGA package in BGA437 socket	
Memory	1GB std, 2GB max⁸, PC2-5300 667MHz DDR2 , non-parity, dual-channel capable, one 240-pin DIMM socket	Bay ① 5.25", 1.6" high, access, standard optical Bay ② 3.0", 1" high, access, 16-in-1 media reader Bay ③ 3.5", 1" high, no access, standard disk Bay ④ 3.5", 1" high, no access, optional disk Slot 1: half-length, full-height, 32-bit PCI Ver 2.3
Graphics	Intel Graphics Media Accelerator 950 (GMA 950) , integrated graphics in 945GC, uses main memory, one 15-pin analog VGA DB-15 connector	
SATA disk	160GB , SATA 3.0Gb/s, 7200 rpm	
SATA controller	Serial ATA, SATA 3.0Gb/s, integrated in ICH7	
SATA DVD±RW	Multi-Burner DL DVD±RW SATA 3.0Gb/s Drive	
SATA cables	Two SATA cables (each 1-drop to device), two SATA connectors	
EIDE controller	None	
EIDE cables	None	
Diskette drive	None	
Media reader	16-in-1 media reader	
Chipset	Intel 945GC Express Chipset , I/O Controller Hub 7 [ICH7] (SATA 3.0Gb/s, ethernet MAC, PCI 2.3, USB, LPC bus), ITE Tech® IT8718 Super I/O	
Front ports	Two USB 2.0, microphone (stereo, 3.5mm), headphone (stereo, 3.5mm)	
Rear ports	Four USB 2.0, one serial (9-pin), keyboard (PS/2), mouse (PS/2), ethernet (RJ-45), monitor (VGA DB-15)	
Rear audio ports	Line-in (stereo, 3.5mm), line-out (stereo, 3.5mm), microphone-in (stereo, 3.5mm)	
Audio	High Definition (HD) audio, ALC662 codec	
External speakers	None	
Internal speaker	None	
Ethernet	10/100 ethernet on planar, Realtek® RTL8102E	
Modem	None	
Security chip	None	
TV tuner	None	
Camera	None	
Keyboard	104-key standard keyboard (PS/2 connector)	
Mouse	Optical Wheel Mouse (USB connector), 400 dpi	
Power supply	280 watts, universal, manual switch	
Preloaded operating system²⁰	<ul style="list-style-type: none"> - Microsoft® Windows® Vista® Home Basic Edition (32-bit) ↳ Vista Basic logo 	Available at these retailers <ul style="list-style-type: none"> • Newegg® • TigerDirect
Preloaded applications⁵	<ul style="list-style-type: none"> • Lenovo™ Rescue System • Driver and Application Installation • Trend Micro™ PC-cillin™ Internet Security 2008 • Windows Live™ Toolbar • Microsoft Office 2007 Trial (60-day) • Corel® WinDVD® (DVD±RW) • CyberLink Power2Go (DVD±RW) 	
		Limited Warranty¹ ↳ 1-year parts and labor ↳ Customer Replaceable Unit (CRU) parts only (with limited onsite service for selected parts ³ , 8 am - 5 pm, Mon - Fri coverage excluding holidays, next business day response time) ↳ Service upgrade options (in eligible locations): ⁹ <ul style="list-style-type: none"> • 3-year Lenovo Onsite Repair 9x5 Next Business Day (43R8882) ↳ 24x7 ¹⁴ toll-free support for warranty issues during the warranty period ¹ via 877-453-6686

See footnotes for important warranty information
 US model announced Jan 13, 2009

Type-model	Slot x bay	Processor	GHz	L2 cache	Cores	Memory ⁸	Media reader	SATA disk	SATA optical	Graphics	Modem	Camera	Vista preload	Avail date
5357-1FU	1x4	Atom 230	1.60	512KB	1	1GB	16-in-1	160GB ²	DVD	GMA 950	None	None	Home Basic	Jan 09
5357-1GU	1x4	Atom 230	1.60	512KB	1	2GB	16-in-1	320GB	DVD±RW	GMA 950	None	None	Home Basic	Jan 09

- **Lenovo Rescue System provides OneKey recovery and OneKey Antivirus without booting into Windows**

Processor	Intel® Atom™ Processor N230 with single-core, Hyper-Threading technology, Intel 64 Technology, Execute Disable Bit, 533MHz system bus, and 512KB L2 cache		Tower <ul style="list-style-type: none"> • Black bezel with glossy finish • 6.9" W X 16.1" D X 14.2" H • 175mm W X 409mm D X 360mm H • 20.1 lb (9.1 kg) in max configuration
Implementation	Processor in Micro-FCBGA package in BGA437 socket		
Memory	1GB or 2GB std. , 2GB max ⁸ , PC2-5300 667MHz DDR2 , non-parity, dual-channel capable, one 240-pin DIMM socket		Bay ① 5.25", 1.6" high, access, standard optical Bay ② 3.0", 1" high, access, 16-in-1 media reader Bay ③ 3.5", 1" high, no access, standard disk Bay ④ 3.5", 1" high, no access, optional disk Slot 1: half-length, full-height, 32-bit PCI Ver 2.3
Graphics	Intel Graphics Media Accelerator 950 (GMA 950) , integrated graphics in 945GC, uses main memory, one 15-pin analog VGA DB-15 connector		
SATA disk	160GB or 320GB , SATA 3.0Gb/s, 7200 rpm		
SATA controller	Serial ATA, SATA 3.0Gb/s, integrated in ICH7		
SATA DVD	<i>Some:</i> DVD-ROM DL SATA 1.5Gb/s 16X-48X Max		
SATA DVD±RW	<i>Some:</i> Multi-Burner DL DVD±RW SATA 1.5Gb/s Drive		
SATA cables	Two SATA cables (each 1-drop to device), two SATA connectors		
EIDE controller	None		
EIDE cables	None		
Diskette drive	None		
Media reader	16-in-1 media reader		
Chipset	Intel 945GC Express Chipset , I/O Controller Hub 7 [ICH7] (SATA 3.0Gb/s, ethernet MAC, PCI 2.3, USB, LPC bus), ITE Tech® IT8718 Super I/O		
Front ports	Two USB 2.0, microphone (stereo, 3.5mm), headphone (stereo, 3.5mm)		
Rear ports	Four USB 2.0, one serial (9-pin), keyboard (PS/2), mouse (PS/2), ethernet (RJ-45), monitor (VGA DB-15)		
Rear audio ports	Line-in (stereo, 3.5mm), line-out (stereo, 3.5mm), microphone-in (stereo, 3.5mm)		
Audio	High Definition (HD) audio, ALC662 codec		
External speakers	None		
Internal speaker	None		
Ethernet	10/100 ethernet on planar, Realtek® RTL8102E		
Modem	None		
Security chip	None		
TV tuner	None		
Camera	None		
Keyboard	104-key standard keyboard (PS/2 connector)		
Mouse	Optical Wheel Mouse (USB connector), 400 dpi		
Power supply	280 watts, universal, manual switch		
Preloaded operating system²⁰	<ul style="list-style-type: none"> - Microsoft® Windows® Vista® Home Basic Edition (32-bit) ◊ Vista Basic logo 		Available at these retailers <ul style="list-style-type: none"> • Lenovo.com
Preloaded applications⁵	<ul style="list-style-type: none"> • Lenovo™ Rescue System • Driver and Application Installation • Trend Micro™ PC-cillin™ Internet Security 2008 • Windows Live™ Toolbar • Microsoft Office 2007 Trial (60-day) • Corel® WinDVD® (Combo, DVD±RW) • CyberLink Power2Go (Combo, DVD±RW) 		
			Limited Warranty¹ ⇨ 1-year parts and labor ⇨ Customer Replaceable Unit (CRU) parts only (with limited onsite service for selected parts³, 8 am - 5 pm, Mon - Fri coverage excluding holidays, next business day response time) ⇨ Service upgrade options (in eligible locations):⁹ <ul style="list-style-type: none"> • 3-year Lenovo Onsite Repair 9x5 Next Business Day (43R8882) ⇨ 24x7¹⁴ toll-free support for warranty issues during the warranty period¹ via 877-453-6686

See footnotes for important warranty information
 US models announced Jan 13, 2009

Part number	Slot x bay	Processor	GHz	L2 cache	Cores	Memory ⁸	Media reader	SATA disk	SATA optical	Graphics	Modem	Camera	Vista preload	Avail date
57088764	4x4	Pentium E2200	2.20	1MB	2	2GB		500GB ²	DVD±RW	GMA 3100	None	None	Home Prem	Oct 08
57088788	4x4	Pentium E2200	2.20	1MB	2	4GB	16-in-1	640GB	DVD±RW	GMA 3100	None	None	Home Prem	Oct 08
57094408	4x4	Pentium E2220	2.40	1MB	2	3GB	16-in-1	320GB	DVD±RW	GMA 3100	None	None	Home Prem	Jan 09
57088774	4x4	Core 2 Duo E7200	2.53	3MB	2	4GB	16-in-1	640GB	DVD±RW	GMA 3100	None	None	Home Prem	Oct 08

- **Lenovo Rescue System provides OneKey recovery and OneKey Antivirus without booting into Windows**

Processor	Intel® Pentium® Dual-Core Processor E2200 or E2220 with dual-core , Intel 64 Technology, Execute Disable Bit, EIST, 800MHz system bus, and 1MB L2 cache or Intel Core™ 2 Duo Processor E7200 with dual-core , Intel 64 Technology, Execute Disable Bit, EIST, and 1066MHz system bus with 3MB L2 cache	Tower <ul style="list-style-type: none"> • Black bezel with glossy finish • 6.9" W X 16.1" D X 14.2" H • 175mm W X 409mm D X 360mm H • 20.1 lb (9.1 kg) in max configuration
Implementation	Processor in FC-LGA6 or FC-LGA8 package in LGA775 socket	
Memory	2GB, 3GB, or 4GB std. 4GB max ⁸ , PC2-5300 667MHz DDR2 , non-parity, dual-channel capable, two 240-pin DIMM sockets <i>Italics:</i> standard memory in both sockets; no sockets available;	Bay ① 5.25", 1.6" high, access, standard optical Bay ② 3.0", 1" high, access, media reader * Bay ③ 3.5", 1" high, no access, standard disk Bay ④ 3.5", 1" high, no access, optional disk * 16-in-1 media reader in some models
Graphics	Intel Graphics Media Accelerator 3100 (GMA 3100) , integrated graphics in G31, uses main memory, one 15-pin analog D-sub connector	Slot 1: half-length, full-height, PCI Express x16 Ver 1.1 Slot 2: half-length, full-height, PCI Express x1 Ver 1.1 Slot 3: half-length, full-height, PCI Express x1 Ver 1.1 Slot 4: half-length, full-height, 32-bit PCI Ver 2.3
SATA disk	320GB, 500GB, or 640GB , SATA 3.0Gb/s, 7200 rpm	
SATA controller	Serial ATA, SATA 3.0Gb/s, integrated in ICH7	
SATA DVD±RW	Multi-Burner DL DVD±RW SATA 1.5Gb/s Drive	
SATA cables	Two SATA cables (each 1-drop to device), four SATA connectors	
EIDE controller	None	
EIDE cables	None	
Diskette drive	None	
Media reader	<i>Some:</i> 16-in-1 media reader	
Chipset	Intel G31 Express Chipset (PCI Express® x16), I/O Controller Hub 7 [ICH7] (SATA 3.0Gb/s, PCI Express x1, ethernet MAC, PCI 2.3, USB, LPC bus), Winbond® W83627DHG or ITE Tech® IT8718F Super I/O	
Front ports	Two USB 2.0, microphone (stereo, 3.5mm), headphone (stereo, 3.5mm)	
Rear ports	Four USB 2.0, one serial (9-pin), keyboard (PS/2), mouse (PS/2), ethernet (RJ-45), monitor (DB-15)	
Rear audio ports	Line-in (stereo, 3.5mm), line-out (stereo, 3.5mm), microphone-in (stereo, 3.5mm)	
Audio	High Definition (HD) audio, ALC662 codec	
External speakers	None	
Internal speaker	None	
Ethernet	10/100 ethernet on planar, Intel 82562GZ (PHY/MAC)	
Modem	None	
Security chip	None	
TV tuner	None	
Camera	None	
Keyboard	104-key standard keyboard (PS/2 connector)	Available at these retailers <ul style="list-style-type: none"> • Newegg® • TigerDirect
Mouse	Optical Wheel Mouse (USB connector), 400 dpi	
Power supply	280 watts, universal, manual switch	Limited Warranty¹ <ul style="list-style-type: none"> ↪ 1-year parts and labor ↪ Customer Replaceable Unit (CRU) parts only (with limited onsite service for selected parts³, 8 am - 5 pm, Mon - Fri coverage excluding holidays, next business day response time) ↪ Service upgrade options (in eligible locations):⁹ <ul style="list-style-type: none"> • 3-year Lenovo Onsite Repair 9x5 Next Business Day (43R8882) ↪ 24x7¹⁴ toll-free support for warranty issues during the warranty period¹ via 877-453-6686
Preloaded operating system²⁰	<ul style="list-style-type: none"> - Microsoft® Windows® Vista® Home Premium Edition (32-bit) ↔ Vista Basic logo 	

See footnotes for important warranty information

ES* US model announced Jan 13, 2009; previous models on October 22, 2008

Type-model	Slot x bay	Processor	GHz	L2 cache	Cores	Memory ³	Media reader	SATA disk	SATA optical	Graphics	Modem	Camera	Vista preload	Avail date
5355-1EU	4x4	Pentium E2200	2.20	1MB	2	2GB		500GB ²	DVD±RW	GMA 3100	None	None	Home Prem	Oct 08
5355-1FU	4x4	Pentium E2200	2.20	1MB	2	3GB	16-in-1	320GB	DVD±RW	GMA 3100	None	None	Home Prem	Nov 08
5355-ADU	4x4	Pentium E2220	2.40	1MB	2	2GB	16-in-1	250GB	DVD±RW	GMA 3100	None	None	Home Prem	Jan 09
5355-1VU	4x4	Pentium E2220	2.40	1MB	2	3GB		320GB	DVD±RW	GMA 3100	None	None	Home Prem	Jan 09
5355-AEU	4x4	Pentium E2220	2.40	1MB	2	3GB	16-in-1	320GB	DVD±RW	GMA 3100	None	None	Home Prem	Jan 09
5355-AFU	4x4	Pentium E2220	2.60	1MB	2	3GB	16-in-1	500GB	DVD±RW	GMA 3100	None	None	Home Prem	Jan 09
5355-2JU	4x4	Pentium E5200	2.50	2MB	2	3GB	16-in-1	500GB	DVD±RW	GMA 3100	None	None	Home Prem	Jan 09
5355-2DU	4x4	Pentium E5200	2.50	2MB	2	4GB	16-in-1	500GB	DVD±RW	GMA 3100	None	None	Home Prem	Nov 08

• **Lenovo Rescue System provides OneKey recovery and OneKey Antivirus without booting into Windows**

Processor	Intel® Pentium® Dual-Core Processor E2200, E2220, or E5200 with dual-core , Intel 64 Technology, Execute Disable Bit, EIST, 800MHz system bus, <i>E2200/E2220</i> : 1MB L2 cache; <i>E5200</i> : 2MB L2 cache Processor in FC-LGA6 package in LGA775 socket	<p>Tower</p> <ul style="list-style-type: none"> • Black bezel with glossy finish • 6.9" W X 16.1" D X 14.2" H • 175mm W X 409mm D X 360mm H • 20.1 lb (9.1 kg) in max configuration <p>Bay ① 5.25", 1.6" high, access, standard optical Bay ② 3.0", 1" high, access, media reader * Bay ③ 3.5", 1" high, no access, standard disk Bay ④ 3.5", 1" high, no access, optional disk * 16-in-1 media reader in some models</p> <p>Slot 1: half-length, full-height, PCI Express x16 Ver 1.1 Slot 2: half-length, full-height, PCI Express x1 Ver 1.1 Slot 3: half-length, full-height, PCI Express x1 Ver 1.1 Slot 4: half-length, full-height, 32-bit PCI Ver 2.3</p>
Implementation		
Memory	2GB, 3GB, or 4GB std , 4GB max ⁸ , PC2-5300 667MHz DDR2 , non-parity, dual-channel capable, two 240-pin DIMM sockets <i>Italics</i> : standard memory in both sockets; no sockets available; <i>Non-italics</i> : standard memory in one socket; one socket available	
Graphics	Intel Graphics Media Accelerator 3100 (GMA 3100) , integrated graphics in G31, uses main memory, one 15-pin analog D-sub connector	
SATA disk	250GB, 320GB, or 500GB , SATA 3.0Gb/s, 7200 rpm	
SATA controller	Serial ATA, SATA 3.0Gb/s, integrated in ICH7	
SATA DVD±RW	Multi-Burner DL DVD±RW SATA 1.5Gb/s Drive	
SATA cables	Two SATA cables (each 1-drop to device), four SATA connectors	
EIDE controller	None	
EIDE cables	None	
Diskette drive	None	
Media reader	<i>Some</i> : 16-in-1 media reader	
Chipset	Intel G31 Express Chipset (PCI Express® x16), I/O Controller Hub 7 [ICH7] (SATA 3.0Gb/s, PCI Express x1, ethernet MAC, PCI 2.3, USB, LPC bus), Winbond® W83627DHG or ITE Tech® IT8718F Super I/O	
Front ports	Two USB 2.0, microphone (stereo, 3.5mm), headphone (stereo, 3.5mm)	
Rear ports	Four USB 2.0, one serial (9-pin), keyboard (PS/2), mouse (PS/2), ethernet (RJ-45), monitor (DB-15)	
Rear audio ports	Line-in (stereo, 3.5mm), line-out (stereo, 3.5mm), microphone-in (stereo, 3.5mm)	
Audio	High Definition (HD) audio, ALC662 codec	
External speakers	None	
Internal speaker	None	
Ethernet	10/100 ethernet on planar, Intel 82562GZ (PHY/MAC)	
Modem	None	
Security chip	None	
TV tuner	None	
Camera	None	
Keyboard	104-key standard keyboard (PS/2 connector)	
Mouse	Optical Wheel Mouse (USB connector), 400 dpi	
Power supply	280 watts, universal, manual switch	
Preloaded operating system²⁰	Preloaded applications⁵	
- Microsoft® Windows® Vista® Home Premium Edition (32-bit) ↔ Vista Basic logo	<ul style="list-style-type: none"> • Lenovo™ Rescue System • Lenovo Healthcare Software • Driver and Application Installation • Trend Micro™ PC-cillin™ Internet Security 2007 • Windows Live™ Toolbar • Microsoft Office 2007 Trial (60-day) • VeriFace™ Facial Recognition™ • Corel® WinDVD® (DVD±RW) • CyberLink Power2Go (DVD±RW) 	
<p>Available at these retailers</p> <ul style="list-style-type: none"> • lenovo.com • Fry's • Circuit City® 		
<p>Limited Warranty¹</p> <ul style="list-style-type: none"> ↔ 1-year parts and labor ↔ Customer Replaceable Unit (CRU) parts only (with limited onsite service for selected parts³, 8 am - 5 pm, Mon - Fri coverage excluding holidays, next business day response time) ↔ Service upgrade options (in eligible locations):⁹ <ul style="list-style-type: none"> • 3-year Lenovo Onsite Repair 9x5 Next Business Day (43R8882) ↔ 24x7¹⁴ toll-free support for warranty issues during the warranty period¹ via 877-453-6686 		



See footnotes for important warranty information

US model announced Jan 13, 2009; previous models on October 22, 2008

© Lenovo (SCL1-2) January 2009

Availability: All offers subject to availability. Lenovo reserves the right to alter product offerings and specifications at any time, without notice. Lenovo is not responsible for photographic or typographic errors.

Warranty: For a copy of applicable product warranties, write to: Warranty Information, P.O. Box 12195, RTP, NC, 27709, Attn: Dept ZPYA/B676. Lenovo makes no representation or warranty regarding third party products or services.

- ¹ **Limited warranty:** Support unrelated to a warranty issue may be subject to additional charges.
- ² **Hard disk drive:** GB = billion bytes, TB = trillion bytes. Accessible capacity is less; up to 4GB is service partition.
- ³ **Customer Replacement Units (CRUs)** are designed to be replaced by customers during the applicable warranty period. Lenovo will send a technician onsite to perform a repair if remote telephone diagnosis does not isolate the problem, if customer replaceable parts are unable to resolve the problem, or at the request of the customer. For a list of customer replaceable parts, contact Lenovo. Support unrelated to a warranty issue may be subject to additional charges.
- ⁵ **Included software** may differ from its retail version (if available), and may not include user manuals or all program functionality. License agreements may apply.
- ⁶ **Post-warranty annual maintenance agreement:** Service begins at the end of the base warranty or the end of any other applied warranty and maintenance option, whichever occurs last. Service delivery is not available the same day the maintenance agreement is purchased. Maintenance agreements must be purchased and the registration successfully completed prior to the service being available.

⁷ **Lenovo Care Services:** Not all machine types and models are covered. Service period begins with the equipment date of purchase. Service must be purchased during the original limited product warranty period. Service levels are response time objectives and are not guarantees. If the machine problem turns out to be a Customer Replaceable Unit (CRU), a part at your discretion, will be express shipped to you for quick replacement. See Lenovo Care terms and conditions for complete details and restrictions.

⁸ **Memory:** For PCs without a separate video card, memory supports both system and video. Accessible system memory is up to 64MB less than the amount stated, depending on video mode.

⁹ **International Warranty Service** is available for most models in any country in which this product is sold and serviced. Service delivery methods and parts availability vary by country, may be different from that in the country of purchase, and are subject to change without notice. Fees and restrictions may apply in some countries.

¹⁰ **Modem speeds:** Public network download speeds are limited to 53Kbps. Upload speeds are limited to 48Kbps for V.92 modems. Actual speeds depend on many factors and are often less than the maximum possible. V.92 functions and speeds require compatible phone line and server equipment. Check with your telephone and ISP service providers for availability.

¹⁴ **Response times may vary.** May exclude some holidays. Telephone support may be subject to additional charges.

²⁰ **Operating System:** Level of support varies by operating system. Operating systems not preloaded on the system may not provide full feature functionality. Refer to lenovo.com/pc/support and enter your machine type and model number for more information.



This publication was developed for products and services offered in the United States. Lenovo may not offer the products, services or features discussed in this document in other countries. Lenovo may withdraw an offering at any time. Information is subject to change without notice. Consult your local representative for information on offerings available in your area.

Lenovo reserves the right to change specifications and other product information at any time without prior notice. Lenovo is not responsible for photographic or typographical errors. **LENOVO PROVIDES THIS PUBLICATION "AS IS" WITHOUT WARRANTY OF ANY KIND, EITHER EXPRESS OR IMPLIED, INCLUDING THE IMPLIED WARRANTIES OF MERCHANTABILITY OR FITNESS FOR A PARTICULAR PURPOSE.** Some jurisdictions do not allow disclaimer of express or implied warranties in certain transactions; therefore this disclaimer may not apply to you.

Trademarks: Lenovo, the Lenovo logo, New World. New Thinking., Access Connections, Rescue and Recovery, ThinkVantage, and ThinkVision are trademarks of Lenovo. Microsoft, Windows, and Vista are registered trademarks of Microsoft Corporation. Intel, the Intel logo, Intel Inside logo, Intel Core and Core Inside are trademarks of Intel Corporation in the US and other countries. AMD, the AMD logo, AMD Athlon, AMD Sempron, and combinations thereof, are trademarks of Advanced Micro Devices, Inc. PCI Express is a trademark of PCI-SIG. Other company, product, or service names may be trademarks or service marks of others.

Visit www.lenovo.com/safecomputing periodically for the latest information on safe and effective computing.

Visit www.lenovo.com/psref for the latest version of Personal Systems Reference.

© Lenovo, 2009.
All rights reserved.

Lenovo
1009 Think Place
Morrisville, NC 27560
U.S.A.

January 2009
jbook.pdf

Personal Systems Reference Intel® PC Processors

January 2009 - Version 350



[Notebook] Intel Celeron M Processor 5xx

Personal Systems Reference (PSREF)

<i>Intel® Celeron® M processor for mobile systems</i>	Clock Perf Mode	Clock Battery Mode	L2 cache	System bus MHz	Core	Hyper-Threading Technology	Virtualization Tech	Execute Disable Bit	Enhanced Intel SpeedStep™ Technology	Intel 64 Tech (EM64T)	Available date
Ultra Low Voltage											
Intel Celeron M Processor 523	933MHz	N/A	1MB	533MHz	Single	No	No	Yes	No	Yes	Sep 2007
Standard Voltage											
Intel Celeron M Processor 520	1.6GHz	N/A	1MB	533MHz	Single	No	No	Yes	No	Yes	Jan 2007
Intel Celeron M Processor 530	1.73GHz	N/A	1MB	533MHz	Single	No	No	Yes	No	Yes	Apr 2007
<hr/>											
Processor generation	Merom										
Marketing name	Intel Celeron M Processor										
Core	Single-core										
Branding	Not part of the Intel Centrino® Processor Technology or Intel Centrino with vPro Processor Technology										
Micro-architecture	Intel Core™ Micro-architecture										
MMX™ / Streaming SIMD	MMX™ (57 new instructions), Streaming SIMD Extensions (70 new instructions)										
SSE2	Streaming SIMD Extensions 2 (144 new instructions)										
SSE3	Streaming SIMD Extensions 3 (13 new instructions)										
Hyper-Threading	None										
Total threads	One thread (one cores with no Hyper-Threading support provides one logical processor)										
Execute Disable (XD) Bit	Protects memory data areas from malicious software execution										
Intel 64 Technology ¹	None										
Virtualization Technology	None										
L1 cache	256-bit data path, full speed										
L1 data cache	32KB data cache, integrated										
L1 instruction cache	32KB instruction cache, integrated										
<hr/>											
L2 cache - size	1MB , full speed										
L2 cache - data path	256-bit data path (32 bytes), 64 byte cache line size, 8-way set associative, integrated, unified (on die)										
L3 cache	None										
<hr/>											
System bus	533MHz (transfers data 4 times per clock), address bus transfers at 2 times per clock										
System bus - width	64-bit data path										
<hr/>											
Execution units	2 integer units, 1 floating point units, 1 load unit, 1 store unit										
Math coprocessor	Pipelined floating point unit										
Compatibility	Compatible with IA-32 software										
<hr/>											
Process technology	65nm or 0.065u										
Thermal Design Power	<i>Ultra Low Voltage</i> : 5 watts; <i>Standard Voltage</i> : 30 watts										
Package and connector	All: Socket M 520/530: Micro Flip-Chip Pin Grid Array (Micro-FCPGA) requires 479-pin surface mount Zero Insertion Force (ZIF) socket (mPGA479M socket) 523: Micro Flip-Chip Ball Grid Array (Micro-FCBGA) for surface mount (479-ball)										
Chipset support	Mobile Intel 945 Express Chipset family ; other compatible chipsets										

Intel® Celeron® mobile processor	Clock Perf Mode	Clock Battery Mode	L2 cache	System bus MHz	Core	Thermal Design Power	Hyper-Threading Technology	Virtualization Tech	Enhanced Intel SpeedStep™ Technology	Intel 64 Tech	Available date
Intel Celeron Processor 530	1.73GHz	N/A	1MB	533MHz	Single	31W	No	No	No	Yes	Sep 2007
Intel Celeron Processor 540	1.86GHz	N/A	1MB	533MHz	Single	31W	No	No	No	Yes	Jun 2007
Intel Celeron Processor 550	2.00GHz	N/A	1MB	533MHz	Single	31W	No	No	No	Yes	Jun 2007
Intel Celeron Processor 560	2.13GHz	N/A	1MB	533MHz	Single	31W	No	No	No	Yes	Jan 2008
Intel Celeron Processor 570	2.26GHz	N/A	1MB	533MHz	Single	31W	No	No	No	Yes	Apr 2008
Intel Celeron Processor 575	2.00GHz	N/A	1MB	667MHz	Single	31W	No	No	No	Yes	Aug 2008
Intel Celeron Processor 585	2.16GHz	N/A	1MB	667MHz	Single	31W	No	No	No	Yes	Aug 2008
Intel Celeron Processor 723	1.20GHz	N/A	1MB	800MHz	Single	10W	No	No	No	Yes	Aug 2008

Processor generation	5xx: Merom ; 7xx: Penryn
Marketing name	Intel Celeron mobile processor
Core	Single-core
Branding	Not part of the Intel Centrino® Processor Technology or Intel Centrino with vPro Processor Technology
Micro-architecture	Intel Core™ Micro-architecture
MMX™ / Streaming SIMD	MMX™ (57 new instructions), Streaming SIMD Extensions (70 new instructions)
SSE2	Streaming SIMD Extensions 2 (144 new instructions)
SSE3	Streaming SIMD Extensions 3 (13 new instructions)
Hyper-Threading	None
Total threads	One thread (one cores with no Hyper-Threading support provides one logical processor)
Execute Disable (XD) Bit	Protects memory data areas from malicious software execution
Intel 64 Technology¹	None
Virtualization Technology	None
L1 cache	256-bit data path, full speed
L1 data cache	32KB data cache, integrated
L1 instruction cache	32KB instruction cache, integrated
L2 cache - size	1MB , full speed
L2 cache - data path	256-bit data path (32 bytes), 64 byte cache line size, 8-way set associative, integrated, unified (on die)
L3 cache	None
System bus	533MHz, 667MHz, or 800MHz (transfers data 4 times per clock), address bus transfers at 2 times per clock
System bus - width	64-bit data path
Execution units	2 integer units, 1 floating point units, 1 load unit, 1 store unit
Math coprocessor	Pipelined floating point unit
Compatibility	Compatible with IA-32 software
Process technology	65nm or 0.065u
Thermal Design Power	5xx: 27-31 watts @ 0.95-1.3 volts 7xx: 10 watts (Ultra Low Voltage)
Package and connector	5xx: Socket P / Micro Flip-Chip Pin Grid Array (Micro-FCPGA) requires 479-pin surface mount Zero Insertion Force (ZIF) socket (mPGA479M socket) 7xx: Socket P / Micro Flip-Chip Ball Grid Array (Micro-FCBGA) for surface mount (479-ball)
Chipset support	5xx: Mobile Intel 965 Express Chipset family ; other compatible chipsets 7xx: Mobile Intel 4 Series Express Chipset family ; other compatible chipsets

[Notebook] Intel Celeron Processor

Personal Systems Reference (PSREF)

<i>Intel® Celeron® mobile processor</i>	Clock Perf Mode	Shared L2 cache	System bus MHz	Core	HD Boost	Virtualization Tech	Execute Disable Bit	Enhanced Intel SpeedStep™ Technology	Intel 64 Tech (EM64T)	Trusted Execution Tech	Available date
Intel Celeron processor T1600	1.66GHz	1MB	667MHz	Dual	No	No	Yes	Yes	Yes	No	Oct 2008
Intel Celeron processor T1700	1.86GHz	1MB	667MHz	Dual	No	No	Yes	Yes	Yes	No	Oct 2008

Processor generation	Montevina
Marketing name	Intel Celeron mobile processor
Core	Dual-core
Branding	Value or essential mobile processor
Micro-architecture	Intel Core Micro-architecture
Intel Wide Dynamic Execution	Each core can complete up to four full instructions simultaneously using 14-stage pipeline
Intel Smart Memory Access	Hides memory latency
Intel Advanced Digital Media Boost	Accelerates execution of Streaming SIMD Extension (SSE2/3) instructions used in multimedia applications
Power mgmt technology	Enhanced Intel SpeedStep™ technology (EIST)
Hyper-Threading	No
Execute Disable (XD) Bit	Protects memory data areas from malicious software execution
Intel 64 Technology ¹ (EM64T)	Intel 64 Technology (an extension to the IA-32 instruction set which adds 64 bit extensions to the x86 architecture)
Intel Virtualization Technology	No
Intel Trusted Execution Technology	No
L1 cache	64KB per core split between data cache (32KB) and instruction cache (32KB)
L1 data cache	2x32KB data cache / integrated
L1 instruction cache	2x32KB instruction cache / integrated
L2 cache - size	1MB / full speed / shared between both cores (Intel Advanced Smart Cache)
L2 cache - data path	256-bit data path (32 bytes) / 64 byte cache line size / 8-way set associative / integrated / unified (on die)
System bus	667MHz (transfers data 4 times per clock) / address bus transfers at 2 times per clock
Memory addressability	64GB memory addressability (but limited by chipset) / 36-bit addressing
System bus - width	64-bit data path
Execution units	2 integer units, 1 floating point units, 1 load unit, 1 store unit
Math coprocessor	Pipelined floating point unit
Compatibility	Compatible with IA-32 software
Process technology	65nm or 0.065u
Thermal Design Power	35 watts
Package and connector	Socket P / Micro Flip-Chip Ball Grid Array (Micro-FCBGA)
Chipset support	Mobile Intel 4 Series Chipset family ; other compatible chipsets

All trademarks are the property of their respective owners
© Lenovo

(DCELM) Compiled by Roger Dodson, Lenovo. January 2009

Intel® Pentium® Processor	Clock Perf Mode	Shared L2 cache	System bus MHz	Hyper-Threading Core	Hyper-Threading Technology	Virtualization Tech	Execute Disable Bit	Enhanced Intel SpeedStep™ Technology	Intel 64 Tech (EM64T)	Trusted Execution Tech	Intel Dynamic Acceleration	Available date
Intel Pentium Processor T2060	1.60GHz	1MB	533MHz	Dual	No	No	Yes	Yes	No	No	No	Jan 2007
Intel Pentium Processor T2080	1.70GHz	1MB	533MHz	Dual	No	No	Yes	Yes	No	No	No	Jan 2007
Intel Pentium Processor T2130	1.86GHz	1MB	533MHz	Dual	No	No	Yes	Yes	No	No	No	Oct 2007
Intel Pentium Processor T2310	1.46GHz	1MB	533MHz	Dual	No	No	Yes	Yes	Yes	No	No	July 2007
Intel Pentium Processor T2330	1.60GHz	1MB	533MHz	Dual	No	No	Yes	Yes	Yes	No	No	July 2007
Intel Pentium Processor T2370	1.73GHz	1MB	533MHz	Dual	No	No	Yes	Yes	Yes	No	No	Jan 2008
Intel Pentium Processor T2390	1.86GHz	1MB	533MHz	Dual	No	No	Yes	Yes	Yes	No	No	Jan 2008
Intel Pentium Processor T3200	2.00GHz	1MB	667MHz	Dual	No	No	Yes	Yes	Yes	No	No	Nov 2008
Intel Pentium Processor T3400	2.16GHz	1MB	667MHz	Dual	No	No	Yes	Yes	Yes	No	No	Nov 2008

Processor generation	T2060/T2080/T2130: Yonah ; T2310/T2330/T2370/T2390/T3200/T3400: Merom
Marketing name	Intel Pentium Processor
Core	Dual-core
Branding	Value or essential mobile processor
Micro-architecture	Intel Core Micro-architecture
Intel Wide Dynamic Execution	Each core can complete up to four full instructions simultaneously using 14-stage pipeline;
Intel Smart Memory Access	Hides memory latency
Intel Advanced Digital Media Boost	Accelerates execution of Streaming SIMD Extension (SSE2/3) instructions used in multimedia applications
Power mgmt technology	Enhanced Intel SpeedStep™ technology
Thermal management	Digital thermal sensor
Hyper-Threading	No
Total threads	Two threads (two cores with no Hyper-Threading support provide two logical processors)
Execute Disable (XD) Bit	Protects memory data areas from malicious software execution
Intel 64 Technology¹ (EM64T)	<i>Some:</i> Intel 64 Technology (an extension to the IA-32 instruction set which adds 64 bit extensions to the x86 architecture)
Intel Virtualization Technology	No
Intel Trusted Execution Technology	No
Intel Dynamic Accerlation	No
L1 cache	64KB per core split between data cache (32KB) and instuction cache (32KB)
L1 data cache	2x32KB data cache / integrated
L1 instruction cache	2x32KB instruction cache / integrated
L2 cache - size	1MB / full speed, shared between both cores (Intel Advanced Smart Cache)
L2 cache - data path	256-bit data path (32 bytes), 64 byte cache line size, 8-way set associative, integrated, unified (on die)
L3 cache	None
System bus	533MHz or 667MHz (transfers data 4 times per clock), address bus transfers at 2 times per clock
Memory addressability	64GB memory addressability (but limited by chipset) / 36-bit addressing
System bus - width	64-bit data path
Execution units	2 integer units, 1 floating point units, 1 load unit, 1 store unit
Math coprocessor	Pipelined floating point unit
Compatibility	Compatible with IA-32 software
Process technology	65nm or 0.065u
Package and connector	T2060/T2080/T2130: Micro Flip-Chip Pin Grid Array (Micro-FCPGA) requires 479-pin surface mount Zero Insertion Force (ZIF) socket (mPGA479M socket) or Micro Flip-Chip Ball Grid Array (Micro-FCBGA) for surface mount (479-ball) T2310/T2330/T2370/T2390/T3200/T3400: Socket P / Micro Flip-Chip Pin Grid Array (Micro-FCPGA) requires 479-pin surface mount Zero Insertion Force (ZIF) socket (mPGA479M socket) or Micro Flip-Chip Ball Grid Array (Micro-FCBGA) for surface mount (479-ball)

[Notebook] Intel Core 2 Solo Processor

<i>Intel® Core™ 2 Solo processor for mobile systems</i>	Clock Perf Mode	L2 cache	System bus MHz	Core	Hyper-Threading Technology	Virtualization Tech	Intel 64 Tech (EM64T)	Intel HD Boost	Intel Dynamic Acceleration	Trusted Execution Tech (TXT)	Available date
Ultra Low Voltage											
Intel Core 2 Solo processor U2100	1.06GHz	1MB	533MHz	Single	No	Yes	Yes	No	No	No	Sep 2007
Intel Core 2 Solo processor U2200	1.20GHz	1MB	533MHz	Single	No	Yes	Yes	No	No	No	Sep 2007
Standard Voltage											
Intel Core 2 Solo processor SU3300	1.20GHz	3MB	800MHz	Single	No	Yes	Yes	Yes	No	Yes	Aug 2008
Intel Core 2 Solo processor SU3500	1.30GHz	3MB	800MHz	Single	No	Yes	Yes	Yes	No	Yes	Aug 2008
<p>Processor generation <i>Uxxxx: Merom (Napa Refresh); SUxxxx: Penryn (Montevina)</i></p> <p>Marketing name Intel Core 2 Solo mobile processor</p> <p>Core Single-core</p> <p>Micro-architecture Intel Core Micro-architecture</p> <p>Intel Wide Dynamic Execution Each core can complete up to four full instructions simultaneously using 14-stage pipeline</p> <p>Intel Smart Memory Access Hides memory latency</p> <p>Intel Advanced Digital Media Boost Accelerates execution of Streaming SIMD Extension (SSE2/3) instructions used in multimedia applications</p> <p>Intel HD Boost <i>Some:</i> Streaming SIMD Extensions 4 (SSE4) and faster Super Shuffle Engine</p> <p>Power management technology Enhanced Intel SpeedStep® technology</p> <p>Intel Dynamic Power Coordination Coordinates Enhanced Intel SpeedStep Technology and idle power-management state transitions independently per core to help save power</p> <p>Intel Dynamic Bus Parking Enables platform power savings and improved battery life by allowing the chipset to power down with the processor in low-frequency mode</p> <p>Enhanced Intel Deeper Sleep with Dynamic Cache Sizing Saves power by flushing cache data to system memory during periods of inactivity to lower CPU voltage</p> <p>Thermal management Digital thermal sensor</p> <p>Hyper-Threading No</p> <p>Execute Disable (XD) Bit Protects memory data areas from malicious software execution</p> <p>Intel 64 Technology¹ (EM64T) Intel 64 Technology (an extension to the IA-32 instruction set which adds 64-bit extensions to the x86 architecture)</p> <p>Virtualization Technology Intel Virtualization Technology</p> <p>Intel Dynamic Acceleration None</p> <p>Intel Trusted Execution Tech (TXT) <i>Some:</i> Provides a more secure platform from software-based attacks with TXT-enabled OS or appl</p>											
<p>L1 cache 64KB per core split between data cache (32KB) and instruction cache (32KB)</p> <p>L1 data cache 32KB data cache / integrated</p> <p>L1 instruction cache 32KB instruction cache / integrated</p>											
<p>L2 cache - size 1MB or 3MB / full speed</p> <p>L2 cache - data path 256-bit data path (32 bytes) / 64 byte cache line size / 8-way set associative / integrated / unified (on die)</p> <p>L3 cache None</p>											
<p>System bus 533MHz or 800MHz (transfers data 4 times per clock) / address bus transfers at 2 times per clock</p> <p>Memory addressability 64GB memory addressability (but limited by chipset) / 36-bit addressing</p> <p>System bus - width 64-bit data path</p>											
<p>Execution units per core 2 integer units, 1 floating point units, 1 load unit, 1 store unit</p> <p>Math coprocessor Pipelined floating point unit</p> <p>Compatibility Compatible with IA-32 software</p>											
<p>Process technology <i>Uxxxx:</i> 65nm; <i>SUxxxx:</i> 45nm</p> <p>Thermal Design Power 5.5 watts</p> <p>Package and connector <i>Uxxxx:</i> Socket M / Micro Flip-Chip Ball Grid Array (Micro-FCBGA) <i>SUxxxx:</i> Socket P / Micro Flip-Chip Ball Grid Array (Micro-FCBGA)</p> <p>Chipset support <i>Uxxxx:</i> Mobile Intel 945GM and 945GMS Express Chipset; other compatible chipsets <i>SUxxxx:</i> Mobile Intel 4 Series Express Chipset; other compatible chipsets</p>											

[Notebook] Intel Core 2 Duo Processor (Socket M)

Personal Systems Reference (PSREF)

Intel® Core™ 2 Duo processor for mobile systems	Clock Perf Mode	Clock Battery Mode	Shared L2 cache	System bus MHz	Hyper-Threading Core	Virtualization Tech	Execute Disable Bit	Enhanced Intel SpeedStep™ Technology	Intel 64 Tech (EM64T)	Intel Dynamic Acceleration	Available date
Intel Core 2 Duo processor U7500	1.06GHz	800MHz	2MB	533MHz	Dual	No	Yes	Yes	Yes	No	Apr 2007
Intel Core 2 Duo processor U7600	1.20GHz	800MHz	2MB	533MHz	Dual	No	Yes	Yes	Yes	No	Apr 2007
Intel Core 2 Duo processor U7700	1.33GHz	800MHz	2MB	533MHz	Dual	No	Yes	Yes	Yes	No	Jun 2007
Intel Core 2 Duo processor L7200	1.33GHz	1.0GHz	4MB	667MHz	Dual	No	Yes	Yes	Yes	No	Jan 2007
Intel Core 2 Duo processor L7400	1.50GHz	1.0GHz	4MB	667MHz	Dual	No	Yes	Yes	Yes	No	Jan 2007
Intel Core 2 Duo processor T5200	1.60GHz	1.0GHz	2MB	533MHz	Dual	No	No	Yes	Yes	No	Jan 2007
Intel Core 2 Duo processor T5300	1.73GHz	1.0GHz	2MB	533MHz	Dual	No	No	Yes	Yes	No	Oct 2007
Intel Core 2 Duo processor T5500	1.66GHz	1.0GHz	2MB	667MHz	Dual	No	No	Yes	Yes	No	July 2006
Intel Core 2 Duo processor T5600	1.83GHz	1.0GHz	2MB	667MHz	Dual	No	Yes	Yes	Yes	No	July 2006
Intel Core 2 Duo processor T7200	2.00GHz	1.0GHz	4MB	667MHz	Dual	No	Yes	Yes	Yes	No	July 2006
Intel Core 2 Duo processor T7400	2.16GHz	1.0GHz	4MB	667MHz	Dual	No	Yes	Yes	Yes	No	July 2006
Intel Core 2 Duo processor T7600	2.33GHz	1.0GHz	4MB	667MHz	Dual	No	Yes	Yes	Yes	No	July 2006

U (Ultra Low Voltage)=<14 watts; L (Low Voltage)=15-24 watts; T (Standard Voltage)=25-49 watts; E=>50 watts

Processor generation	Merom
Marketing name	Intel Core 2 Duo mobile processor
Core	Dual-core
Micro-architecture	Intel Core Micro-architecture
Intel Wide Dynamic Execution	Each core can complete up to four full instructions simultaneously using 14-stage pipeline
Intel Smart Memory Access	Hides memory latency
Intel Advanced Digital Media Boost	Accelerates execution of Streaming SIMD Extension (SSE2/3) instructions used in multimedia applications
Power management technology	Enhanced Intel SpeedStep® technology
Intel Dynamic Power Coordination	Coordinates Enhanced Intel SpeedStep Technology and idle power-management state transitions independently per core to help save power
Intel Dynamic Bus Parking	Enables platform power savings and improved battery life by allowing the chipset to power down with the processor in low-frequency mode
Enhanced Intel Deeper Sleep with Dynamic Cache Sizing	Saves power by flushing cache data to system memory during periods of inactivity to lower CPU voltage
Thermal management	Digital thermal sensor
Hyper-Threading	No
Total threads	Two threads (two cores with no Hyper-Threading support provide two logical processors)
Execute Disable (XD) Bit	Protects memory data areas from malicious software execution
Intel 64 Technology ¹ (EM64T)	Intel 64 Technology (an extension to the IA-32 instruction set which adds 64-bit extensions to the x86 architecture)
Virtualization Technology	<i>Some:</i> Intel Virtualization Technology
Intel Dynamic Acceleration	<i>Some:</i> Intel Dynamic Acceleration (IDA) allows one core to deliver extra performance when other core is idle
L1 cache	64KB per core split between data cache (32KB) and instruction cache (32KB)
L1 data cache	2x32KB data cache / integrated
L1 instruction cache	2x32KB instruction cache / integrated
L2 cache - size	2MB or 4MB / full speed / shared between both cores (Intel Advanced Smart Cache)
L2 cache - data path	256-bit data path (32 bytes) / 64 byte cache line size / 8-way set associative / integrated / unified (on die)
L3 cache	None
System bus	533MHz , 667MHz , or 800MHz (transfers data 4 times per clock) / address bus transfers at 2 times per clock
Memory addressability	64GB memory addressability (but limited by chipset) / 36-bit addressing
System bus - width	64-bit data path
Execution units per core	2 integer units, 1 floating point units, 1 load unit, 1 store unit
Math coprocessor	Pipelined floating point unit
Compatibility	Compatible with IA-32 software
Process technology	65nm or 0.065u
Thermal Design Power	<i>U7xxx:</i> 10 watts; <i>L7xxx:</i> 17 watts; <i>Txxxx:</i> 34 watts
Package and connector	Socket M / Micro Flip-Chip Pin Grid Array (Micro-FCPGA) requires 479-pin surface mount Zero Insertion Force (ZIF) socket (mPGA479M socket) or Micro Flip-Chip Ball Grid Array (Micro-FCBGA) for surface mount (479-ball)
Chipset support	Mobile Intel 945 Express Chipset family ; other compatible chipsets

[Notebook] Intel Core 2 Duo Processor (Socket P)

Personal Systems Reference (PSREF)

Intel® Core™ 2 Duo processor for mobile systems	Clock Perf Mode	Clock Battery Mode	Shared L2 cache	System bus MHz	Core	Virtualization Tech	Execute Disable Bit	Enhanced Intel SpeedStep™ Technology	Intel 64 Tech (EM64T)	Intel Dynamic Acceleration	Available date
Intel Core 2 Duo processor U7500	1.06GHz	800MHz	2MB	533MHz	Dual	Yes	Yes	Yes	Yes	Yes	Jun 2007
Intel Core 2 Duo processor U7600	1.20GHz	800MHz	2MB	533MHz	Dual	Yes	Yes	Yes	Yes	Yes	Jun 2007
Intel Core 2 Duo processor U7700	1.33GHz	800MHz	2MB	533MHz	Dual	Yes	Yes	Yes	Yes	Yes	Jan 2008
Intel Core 2 Duo processor SL7100	1.2GHz	800MHz	4MB	800MHz	Dual	Yes	Yes	Yes	Yes	Yes	Feb 2008
Intel Core 2 Duo processor L7300	1.4GHz	800MHz	4MB	800MHz	Dual	Yes	Yes	Yes	Yes	Yes	May 2007
Intel Core 2 Duo processor L7500	1.6GHz	800MHz	4MB	800MHz	Dual	Yes	Yes	Yes	Yes	Yes	May 2007
Intel Core 2 Duo processor L7700	1.8GHz	800MHz	4MB	800MHz	Dual	Yes	Yes	Yes	Yes	Yes	Sep 2007
Intel Core 2 Duo processor T5250	1.50GHz	667MHz	2MB	667MHz	Dual	No	Yes	Yes	Yes	No	July 2007
Intel Core 2 Duo processor T5270	1.40GHz	1.0GHz	2MB	800MHz	Dual	No	Yes	Yes	Yes	Yes	Aug 2007
Intel Core 2 Duo processor T5450	1.66GHz	667MHz	2MB	667MHz	Dual	No	Yes	Yes	Yes	No	July 2007
Intel Core 2 Duo processor T5470	1.60GHz	1.0GHz	2MB	800MHz	Dual	No	Yes	Yes	Yes	Yes	Aug 2007
Intel Core 2 Duo processor T5550	1.83GHz	667MHz	2MB	667MHz	Dual	No	Yes	Yes	Yes	No	July 2007
Intel Core 2 Duo processor T5670	1.80GHz	800MHz	2MB	800MHz	Dual	No	Yes	Yes	Yes	Yes	July 2008
Intel Core 2 Duo processor T5750	2.00GHz	667MHz	2MB	667MHz	Dual	No	Yes	Yes	Yes	No	Feb 2008
Intel Core 2 Duo processor T5850	2.16GHz	667MHz	2MB	667MHz	Dual	No	Yes	Yes	Yes	No	Feb 2008
Intel Core 2 Duo processor T5870	2.00GHz	800MHz	2MB	800MHz	Dual	No	Yes	Yes	Yes	Yes	Oct 2008
Intel Core 2 Duo processor T7100	1.8GHz	800MHz	2MB	800MHz	Dual	Yes	Yes	Yes	Yes	Yes	May 2007
Intel Core 2 Duo processor T7250	2.0GHz	800MHz	2MB	800MHz	Dual	Yes	Yes	Yes	Yes	Yes	Sep 2007
Intel Core 2 Duo processor T7300	2.0GHz	800MHz	4MB	800MHz	Dual	Yes	Yes	Yes	Yes	Yes	May 2007
Intel Core 2 Duo processor T7500	2.2GHz	800MHz	4MB	800MHz	Dual	Yes	Yes	Yes	Yes	Yes	May 2007
Intel Core 2 Duo processor T7700	2.4GHz	800MHz	4MB	800MHz	Dual	Yes	Yes	Yes	Yes	Yes	May 2007
Intel Core 2 Duo processor T7800	2.6GHz	800MHz	4MB	800MHz	Dual	Yes	Yes	Yes	Yes	Yes	Sep 2007

U (Ultra Low Voltage)=<14 watts; L (Low Voltage)=15-24 watts; T (Standard Voltage)=25-49 watts; E=>50 watts

Processor generation	Merom
Marketing name	Intel Core 2 Duo mobile processor
Core	Dual-core
Micro-architecture	Intel Core Micro-architecture
Intel Wide Dynamic Execution	Each core can complete up to four full instructions simultaneously using 14-stage pipeline
Intel Smart Memory Access	Hides memory latency
Intel Advanced Digital Media Boost	Accelerates execution of Streaming SIMD Extension (SSE2/3) instructions used in multimedia applications
Power management technology	Enhanced Intel SpeedStep® technology
Intel Dynamic Power Coordination	Coordinates Enhanced Intel SpeedStep Technology and idle power-management state transitions independently per core to help save power
Intel Dynamic Bus Parking	Enables platform power savings and improved battery life by allowing the chipset to power down with the processor in low-frequency mode
Enhanced Intel Deeper Sleep with Dynamic Cache Sizing	Saves power by flushing cache data to system memory during periods of inactivity to lower CPU voltage
Dynamic Front Side Bus Frequency Switching	<i>Some (not T5xxx):</i> Changes the bus clock frequency allowing a reduction in core voltage enabling a lower power active state called super LFM
Thermal management	Digital thermal sensor
Hyper-Threading	No
Execute Disable (XD) Bit	Protects memory data areas from malicious software execution
Intel 64 Technology ¹ (EM64T)	Intel 64 Technology (an extension to the IA-32 instruction set which adds 64-bit extensions to the x86 architecture)
Virtualization Technology	<i>Some:</i> Intel Virtualization Technology (VT)
Intel Dynamic Acceleration	<i>Some:</i> Intel Dynamic Acceleration (IDA) allows one core to deliver extra performance when other core is idle
L1 cache	64KB per core split between data cache (32KB) and instruction cache (32KB)
L1 data cache	2x32KB data cache, integrated
L1 instruction cache	2x32KB instruction cache, integrated
L2 cache - size	2MB or 4MB , full speed, shared between both cores (Intel Advanced Smart Cache)
L2 cache - data path	256-bit data path (32 bytes), 64 byte cache line size, 8-way set associative, integrated, unified (on die)
System bus (front side bus)	533MHz, 667MHz, or 800MHz (transfers data 4 times per clock) / address bus transfers at 2 times per clock
Memory addressability	64GB memory addressability (but limited by chipset), 36-bit addressing
System bus - width	64-bit data path
Execution units per core	2 integer units, 1 floating point units, 1 load unit, 1 store unit
Math coprocessor	Pipelined floating point unit
Process technology	65nm or 0.065u
Thermal Design Power	<i>U7xxx:</i> 10 watts; <i>L7xxx:</i> 17 watts; <i>Txxxx:</i> 35 watts
Package and connector	Socket P / Micro Flip-Chip Pin Grid Array (Micro-FCPGA) requires 479-pin surface mount Zero Insertion Force (ZIF) socket (mPGA479M socket) or Micro Flip-Chip Ball Grid Array (Micro-FCBGA) for surface mount (479-ball)
Chipset support	Mobile Intel 965 Express Chipset family ; other compatible chipsets

[Notebook] Intel Core 2 Duo Processor (Penryn)

Personal Systems Reference (PSREF)

Intel® Core™ 2 Duo processor for notebook systems	Clock Perf Mode	Shared L2 cache	System bus MHz	Core	Thermal Design Power	Virtualization Tech	Intel 64 Tech	Intel Dynamic Acceleration	Trusted Execution Tech (TXT)	Available date
Intel Core 2 Duo processor T6400	2.0GHz	2MB	800MHz	Dual	35W	Yes	Yes	Yes	No	Jan 2009
Intel Core 2 Duo processor T6600	2.2GHz	2MB	800MHz	Dual	35W	Yes	Yes	Yes	No	Jan 2009
Intel Core 2 Duo processor T8100	2.1GHz	3MB	800MHz	Dual	35W	Yes	Yes	Yes	No	Jan 2008
Intel Core 2 Duo processor T8300	2.4GHz	3MB	800MHz	Dual	35W	Yes	Yes	Yes	No	Jan 2008
Intel Core 2 Duo processor T9300	2.5GHz	6MB	800MHz	Dual	35W	Yes	Yes	Yes	No	Jan 2008
Intel Core 2 Duo processor T9500	2.6GHz	6MB	800MHz	Dual	35W	Yes	Yes	Yes	No	Jan 2008
Intel Core 2 Duo processor P7370	2.00GHz	3MB	1066MHz	Dual	25W	Yes	Yes	Yes	Yes	Sep 2008
Intel Core 2 Duo processor P7450	2.13GHz	3MB	1066MHz	Dual	25W	Yes	Yes	Yes	Yes	Jan 2009
Intel Core 2 Duo processor P8400	2.26GHz	3MB	1066MHz	Dual	25W	Yes	Yes	Yes	Yes	July 2008
Intel Core 2 Duo processor P8600	2.4GHz	3MB	1066MHz	Dual	25W	Yes	Yes	Yes	Yes	July 2008
Intel Core 2 Duo processor P8700	2.53GHz	3MB	1066MHz	Dual	25W	Yes	Yes	Yes	Yes	Dec 2008
Intel Core 2 Duo processor P9500	2.53GHz	6MB	1066MHz	Dual	25W	Yes	Yes	Yes	Yes	July 2008
Intel Core 2 Duo processor P9600	2.66GHz	6MB	1066MHz	Dual	25W	Yes	Yes	Yes	Yes	Dec 2008
Intel Core 2 Duo processor T9400	2.53GHz	6MB	1066MHz	Dual	35W	Yes	Yes	Yes	Yes	July 2008
Intel Core 2 Duo processor T9550	2.66GHz	6MB	1066MHz	Dual	35W	Yes	Yes	Yes	Yes	Dec 2008
Intel Core 2 Duo processor T9600	2.8GHz	6MB	1066MHz	Dual	35W	Yes	Yes	Yes	Yes	July 2008
Intel Core 2 Duo processor T9800	2.93GHz	6MB	1066MHz	Dual	35W	Yes	Yes	Yes	Yes	Dec 2008

U (Ultra Low Voltage)=<12 watts; L (Low Voltage)=12-19 watts; P =20-29 watts; T (Standard Voltage)=30-39 watts; X or QX=>40 watts

Processor generation	<i>T8100/T8300/T9300/T9500</i> : Penryn (Santa Rosa Refresh) ; <i>Others</i> : Penryn (Montevina)
Marketing name	Intel Core 2 Duo mobile processor
Core	Dual-core
Branding	Supports Intel Centrino® 2 Processor Technology or Intel Centrino 2 with vPro Processor Technology when hardware and software requirements met
Micro-architecture	Intel Core Micro-architecture
Intel Wide Dynamic Execution	Each core can complete up to four full instructions simultaneously using 14-stage pipeline
Intel Smart Memory Access	Hides memory latency
Intel Advanced Digital Media Boost	Accelerates execution of Streaming SIMD Extension (SSE2/3) instructions used in multimedia applications
Intel HD Boost	Streaming SIMD Extensions 4 (SSE4) and faster Super Shuffle Engine
Power management technology	Enhanced Intel SpeedStep® technology
Intel Dynamic Power Coordination	Coordinates Enhanced Intel SpeedStep™ Technology and idle power-management state transitions independently per core to help save power
Intel Deep Power Down Technology	Low-power state that allows both cores and L2 cache to be powered down when processor idle
Thermal management	Digital thermal sensor
Hyper-Threading	No
Total threads	Two threads (two cores with no Hyper-Threading support provide two logical processors)
Execute Disable (XD) Bit	Protects memory data areas from malicious software execution
Intel 64 Technology ¹	Intel 64 Technology (an extension to the IA-32 instruction set which adds 64-bit extensions to the x86 architecture)
Virtualization Technology	Intel Virtualization Technology (VT)
Intel Dynamic Acceleration	Intel Dynamic Acceleration (IDA) allows one core to deliver extra performance when other core is idle
Intel Trusted Execution Tech (TXT)	Provides a more secure platform with protection from software-based attacks with TXT-enabled OS or appl
L1 cache	64KB per core split between data cache (32KB) and instruction cache (32KB)
L1 data cache	2x32KB data cache, integrated
L1 instruction cache	2x32KB instruction cache, integrated
L2 cache - size	2MB, 3MB, or 6MB , full speed, shared between both cores (Intel Advanced Smart Cache)
L2 cache - data path	256-bit data path (32 bytes), 64 byte cache line size, 8-way set associative, integrated, unified (on die)
System bus (front side bus)	800MHz or 1066MHz (transfers data 4 times per clock), address bus transfers at 2 times per clock
Memory addressability	64GB memory addressability (but limited by chipset), 36-bit addressing
System bus - width	64-bit data path
Execution units per core	2 integer units, 1 floating point units, 1 load unit, 1 store unit
Math coprocessor	Pipelined floating point unit
Compatibility	Compatible with IA-32 software
Process technology	45nm
Thermal Design Power	<i>Pxxxx</i> : 25 watts; <i>Txxxx</i> : 35 watts
Package and connector	Socket P / Micro Flip-Chip Pin Grid Array (Micro-FCPGA) requires 479-pin surface mount Zero Insertion Force (ZIF) socket (mPGA479M socket) or Micro Flip-Chip Ball Grid Array (Micro-FCBGA) for surface mount (479-ball)
Chipset support	Mobile Intel 965 Express Chipset family; Mobile Intel 4 Series Chipset family ; other compatible chipsets

[Notebook] Intel Core 2 Duo Processor (SFF)

Intel® Core™ 2 Duo processor Small Form Factor (SFF) for notebook systems	Clock Perf Mode	Shared L2 cache	System bus MHz	Core	Thermal Design Power	Intel HD Boost	Intel 64 Tech	Intel Dynamic Acceleration	Trusted Execution Tech (TXT)	Avail- able date
Intel Core 2 Duo processor SU9300	1.20GHz	3MB	800MHz	Dual	10W	Yes	Yes	Yes	Yes	Aug 2008
Intel Core 2 Duo processor SU9400	1.40GHz	3MB	800MHz	Dual	10W	Yes	Yes	Yes	Yes	Aug 2008
Intel Core 2 Duo processor SL9300	1.60GHz	6MB	1066MHz	Dual	17W	Yes	Yes	Yes	Yes	Aug 2008
Intel Core 2 Duo processor SL9400	1.86GHz	6MB	1066MHz	Dual	17W	Yes	Yes	Yes	Yes	Aug 2008
Intel Core 2 Duo processor SP9300	2.26GHz	6MB	1066MHz	Dual	25W	Yes	Yes	Yes	Yes	Aug 2008
Intel Core 2 Duo processor SP9400	2.40GHz	6MB	1066MHz	Dual	25W	Yes	Yes	Yes	Yes	Aug 2008

• **Small Form Factor (SFF) notebook processors**

- **SUxxxx = Ultra Low Voltage**
- **SLxxxx = Low Voltage**
- **SPxxxx = Power Optimized Performance**

Processor generation	Penryn (Montevina)
Marketing name	Intel Core 2 Duo mobile processor
Core	Dual-core
Branding	Supports Intel Centrino® 2 Processor Technology or Intel Centrino 2 with vPro Processor Technology when hardware and software requirements met
Micro-architecture	Intel Core Micro-architecture
Intel Wide Dynamic Execution	Each core can complete up to four full instructions simultaneously using 14-stage pipeline
Intel Smart Memory Access	Hides memory latency
Intel Advanced Digital Media Boost	Accelerates execution of Streaming SIMD Extension (SSE2/3) instructions used in multimedia applications
Intel HD Boost	Streaming SIMD Extensions 4 (SSE4) and faster Super Shuffle Engine
Power management technology	Enhanced Intel SpeedStep® technology
Intel Dynamic Power Coordination	Coordinates Enhanced Intel SpeedStep™ Technology and idle power-management state transitions independently per core to help save power
Intel Dynamic Bus Parking	Enables platform power savings and improved battery life by allowing the chipset to power down with the processor in low-frequency mode
Enhanced Intel Deeper Sleep with Dynamic Cache Sizing	Saves power by flushing cache data to system memory during periods of inactivity to lower CPU voltage
Intel Deep Power Down Technology	Low-power state that allows both cores and L2 cache to be powered down when processor idle
Thermal management	Digital thermal sensor
Hyper-Threading	No
Total threads	Two threads (two cores with no Hyper-Threading support provide two logical processors)
Execute Disable (XD) Bit	Protects memory data areas from malicious software execution
Intel 64 Technology ¹	Intel 64 Technology (an extension to the IA-32 instruction set which adds 64-bit extensions to the x86 architecture)
Virtualization Technology	Intel Virtualization Technology (VT)
Intel Dynamic Acceleration	Intel Dynamic Acceleration (IDA) allows one core to deliver extra performance when other core is idle
Intel Trusted Execution Tech (TXT)	Provides a more secure platform with protection from software-based attacks with TXT-enabled OS or appl
L1 cache	64KB per core split between data cache (32KB) and instruction cache (32KB)
L1 data cache	2x32KB data cache, integrated
L1 instruction cache	2x32KB instruction cache, integrated
L2 cache - size	3MB or 6MB , full speed, shared between both cores (Intel Advanced Smart Cache)
L2 cache - data path	256-bit data path (32 bytes), 64 byte cache line size, 8-way set associative, integrated, unified (on die)
L3 cache	None
System bus (front side bus)	800MHz or 1066MHz (transfers data 4 times per clock), address bus transfers at 2 times per clock
Memory addressability	64GB memory addressability (but limited by chipset), 36-bit addressing
System bus - width	64-bit data path
Execution units per core	2 integer units, 1 floating point units, 1 load unit, 1 store unit
Math coprocessor	Pipelined floating point unit
Compatibility	Compatible with IA-32 software
Process technology	45nm
Thermal Design Power	SUxxxx : 10 watts; SLxxxx : 17 watts; SUxxxx : 25 watts
Package and connector	Socket P / Micro Flip-Chip Ball Grid Array (Micro-FCBGA) for surface mount (479-ball)
Chipset support	Mobile Intel 4 Series Chipset family ; other compatible chipsets

[Notebook] Intel Core 2 Quad Processor

Intel® Core™ 2 Quad processor for notebook systems	Clock Perf Mode	Shared L2 cache	System bus MHz	Core	Thermal Design Power	Virtualization Tech	Intel 64 Tech	Intel Dynamic Acceleration	Trusted Execution Tech (TXT)	Available date
Intel Core 2 Quad processor Q9000	2.00GHz	6MB	1066MHz	Quad	45W	Yes	Yes	Yes	No	Dec 2008
Intel Core 2 Quad processor Q9100	2.26GHz	12MB	1066MHz	Quad	45W	Yes	Yes	Yes	No	Aug 2008

Processor generation	Penryn (Montevina)
Marketing name	Intel Core 2 Quad mobile processor
Core	Quad-core
Branding	Supports Intel Centrino® 2 Processor Technology or Intel Centrino 2 with vPro Processor Technology when hardware and software requirements met
Micro-architecture	Intel Core micro-architecture
Intel Wide Dynamic Execution	Each core can complete up to four full instructions simultaneously using 14-stage pipeline
Intel Smart Memory Access	Hides memory latency
Intel Advanced Digital Media Boost	Accelerates execution of Streaming SIMD Extension (SSE2/3) instructions used in multimedia applications
Intel HD Boost	Streaming SIMD Extensions 4 (SSE4) and faster Super Shuffle Engine
Power management technology	Enhanced Intel SpeedStep® technology
Intel Dynamic Power Coordination	Coordinates Enhanced Intel SpeedStep™ Technology and idle power-management state transitions independently per core to help save power
Intel Dynamic Bus Parking	Enables platform power savings and improved battery life by allowing the chipset to power down with the processor in low-frequency mode
Enhanced Intel Deeper Sleep with Dynamic Cache Sizing	Saves power by flushing cache data to system memory during periods of inactivity to lower CPU voltage
Intel Deep Power Down Technology	Low-power state that allows both cores and L2 cache to be powered down when processor idle
Thermal management	Digital thermal sensor
Hyper-Threading	No
Total threads	Two threads (two cores with no Hyper-Threading support provide two logical processors)
Execute Disable (XD) Bit	Protects memory data areas from malicious software execution
Intel 64 Technology ¹	Intel 64 Technology (an extension to the IA-32 instruction set which adds 64-bit extensions to the x86 architecture)
Virtualization Technology	Intel Virtualization Technology (VT)
Intel Dynamic Acceleration	Intel Dynamic Acceleration (IDA) allows one core to deliver extra performance when other core is idle
Intel Trusted Execution Tech (TXT)	Provides a more secure platform with protection from software-based attacks with TXT-enabled OS or appl
L1 cache	64KB per core split between data cache (32KB) and instruction cache (32KB)
L1 data cache	2x32KB data cache, integrated
L1 instruction cache	2x32KB instruction cache, integrated
L2 cache - size	6MB or 12MB , full speed, shared between cores (Intel Advanced Smart Cache)
L2 cache - data path	256-bit data path (32 bytes), 64 byte cache line size, 8-way set associative, integrated, unified (on die)
L3 cache	None
System bus (front side bus)	1066MHz (transfers data 4 times per clock), address bus transfers at 2 times per clock
Memory addressability	64GB memory addressability (but limited by chipset), 36-bit addressing
System bus - width	64-bit data path
Execution units per core	2 integer units, 1 floating point units, 1 load unit, 1 store unit
Math coprocessor	Pipelined floating point unit
Compatibility	Compatible with IA-32 software
Process technology	45nm
Thermal Design Power	45 watts
Package and connector	Socket P / Micro Flip-Chip Pin Grid Array (Micro-FCPGA) requires 479-pin surface mount Zero Insertion Force (ZIF) socket (mPGA479M socket) or Micro Flip-Chip Ball Grid Array (Micro-FCBGA) for surface mount (479-ball)
Chipset support	Mobile Intel 4 Series Chipset family ; other compatible chipsets

[Notebook] Intel Core 2 Extreme Processor

Personal Systems Reference (PSREF)

Intel® Core™ 2 Extreme processor for notebook systems	Clock Perf Mode	Shared L2 cache	System bus MHz	Core	HD Boost	Virtualization Tech	Enhanced Intel SpeedStep™ Technology	Intel 64 Tech (EM64T)	Intel Dynamic Acceleration	Trusted Execution Tech (TXT)	Available date
Intel Core 2 Extreme processor X7800	2.60GHz	4MB	800MHz	Dual	No	Yes	Yes	Yes	No	No	July 2007
Intel Core 2 Extreme processor X7900	2.80GHz	4MB	800MHz	Dual	No	Yes	Yes	Yes	No	No	Aug 2007
Intel Core 2 Extreme processor X9000	2.80GHz	6MB	800MHz	Dual	Yes	Yes	Yes	Yes	No	Yes	Jan 2008
Intel Core 2 Extreme processor X9100	3.06GHz	6MB	1066MHz	Dual	Yes	Yes	Yes	Yes	No	Yes	July 2008
Intel Core 2 Extreme processor QX9300	2.53GHz	12MB	1066MHz	Quad	Yes	Yes	Yes	Yes	Yes	No	Aug 2008

Processor generation	<i>X7800/X7900: Merom (Santa Rosa); X9000/X9100: Penryn (Santa Rosa Refresh); QX9300: Penryn</i>
Marketing name	Intel Core 2 Extreme processor
Core(s)	Dual-core or quad-core
Branding	Intel's highest performance brand for processors
Micro-architecture	Intel Core micro-architecture
Intel Wide Dynamic Execution	Each core can complete up to four full instructions simultaneously using 14-stage pipeline
Intel Smart Memory Access	Hides memory latency
Intel Advanced Digital Media Boost	Accelerates execution of Streaming SIMD Extension (SSE2/3) instructions used in multimedia applications
Intel HD Boost	<i>X9000/X9100/QX9300: Streaming SIMD Extensions 4 (SSE4) and faster Super Shuffle Engine</i>
Power mgmt technology	Enhanced Intel SpeedStep™ technology
Thermal management	Digital thermal sensor
Hyper-Threading	No
Total threads	Two threads (two cores with no Hyper-Threading support provide two logical processors)
Execute Disable (XD) Bit	Protects memory data areas from malicious software execution
Intel 64 Technology ¹ (EM64T)	Intel 64 Technology (an extension to the IA-32 instruction set which adds 64 bit extensions to the x86 architecture)
Virtualization Technology	Intel Virtualization Technology
Intel Dynamic Acceleration	<i>Some: Intel Dynamic Acceleration (IDA) allows one core to deliver extra performance when other core is idle</i>
Intel Trusted Execution Tech (TXT)	<i>Some: Provides a more secure platform from software-based attacks with TXT-enabled OS or appl</i>
L1 cache	64KB per core split between data cache (32KB) and instruction cache (32KB)
L1 data cache	2x32KB data cache, integrated
L1 instruction cache	2x32KB instruction cache, integrated
L2 cache - size	4MB, 6MB, or 12MB , full speed, shared between both cores (Intel Advanced Smart Cache)
L2 cache - data path	256-bit data path (32 bytes), 64 byte cache line size, 8-way set associative, integrated, unified (on die)
L3 cache	None
System bus	800MHz or 1066MHz (transfers data 4 times per clock), address bus transfers at 2 times per clock
Memory addressability	64GB memory addressability (but limited by chipset), 36-bit addressing
System bus - width	64-bit data path
Execution units per core	2 integer units, 1 floating point units, 1 load unit, 1 store unit
Math coprocessor	Pipelined floating point unit
Compatibility	Compatible with IA-32 software
Process technology	<i>X7800/X7900: 65nm; X9000/X9100/QS9300: 45nm</i>
Thermal Design Power	44 or 45 watts
Package and connector	Socket P / Micro Flip-Chip Pin Grid Array (Micro-FCPGA) requires 479-pin surface mount Zero Insertion Force (ZIF) socket (mPGA479M socket) or Micro Flip-Chip Ball Grid Array (Micro-FCBGA) for surface mount (479-ball)
Chipset support	Mobile Intel 965 Express Chipset family ; other compatible chipsets

All trademarks are the property of their respective owners
© Lenovo

(XM) Compiled by Roger Dodson, Lenovo. August 2008

[Desktop] Intel Celeron Processor 4xx

Intel® Celeron® Processor	Clock Perf Mode	L2 cache	System bus MHz	Hyper-Threading Core Technology	Total threads (logical)	Virtualization Tech	Execute Disable Bit	Enhanced Intel SpeedStep™ Technology	Intel 64 Tech (EM64T)	Trusted Execution Tech	Available date	
Intel Celeron Processor 420	1.60GHz	512KB	800MHz	Single	No	1	No	Yes	No	Yes	No	Jun 2007
Intel Celeron Processor 430	1.80GHz	512KB	800MHz	Single	No	1	No	Yes	No	Yes	No	Jun 2007
Intel Celeron Processor 440	2.00GHz	512KB	800MHz	Single	No	1	No	Yes	No	Yes	No	Jun 2007
Intel Celeron Processor 450	2.20GHz	512KB	800MHz	Single	No	1	No	Yes	No	Yes	No	Aug 2008

Processor generation	Conroe-L
Marketing name	Intel Celeron Processor
Core	Single-core
Branding	Value or essential desktop processor
Micro-architecture	Intel Core Micro-architecture
Intel Wide Dynamic Execution	Each core can complete up to four full instructions simultaneously using 14-stage pipeline;
Intel Smart Memory Access	Hides memory latency
Intel Advanced Digital Media Boost	Accelerates execution of Streaming SIMD Extension (SSE2/3) instructions used in multimedia applications
Power mgmt technology	No Enhanced Intel SpeedStep™ technology
Thermal management	Digital thermal sensor
Hyper-Threading	No
Total threads	One thread
Execute Disable (XD) Bit	Protects memory data areas from malicious software execution
Intel 64 Technology ¹ (EM64T)	Intel 64 Technology (an extension to the IA-32 instruction set which adds 64 bit extensions to the x86 architecture)
Intel Virtualization Technology	No
Intel Trusted Execution Technology	No
L1 cache	64KB per core split between data cache (32KB) and instruction cache (32KB)
L1 data cache	2x32KB data cache / integrated
L1 instruction cache	2x32KB instruction cache / integrated
L2 cache - size	512KB / full speed
L2 cache - data path	256-bit data path (32 bytes) / 64 byte cache line size / 8-way set associative / integrated / unified (on die)
L3 cache	None
System bus	800MHz (transfers data 4 times per clock) / address bus transfers at 2 times per clock
Memory addressability	64GB memory addressability (but limited by chipset) / 36-bit addressing
System bus - width	64-bit data path
Execution units	2 integer units, 1 floating point units, 1 load unit, 1 store unit
Math coprocessor	Pipelined floating point unit
Compatibility	Compatible with IA-32 software
Process technology	65nm or 0.065u
Thermal Design Power	65 watts
Package and connector	775-land Flip-Chip Land Grid Array (FC-LGA6) package requires LGA775 socket (socket also called Socket T)
Chipset support	Intel 3 Series Express Chipset family ; Intel 945 and 965 Express Chipset family; other compatible chipsets

All trademarks are the property of their respective owners
 © Lenovo

(CEL4) Compiled by Roger Dodson, Lenovo. September 2008

[Desktop] Intel Celeron Processor

Personal Systems Reference (PSREF)

<i>Intel® Celeron® Processor</i>	Clock Perf Mode	Shared L2 cache	System bus MHz	Core	HD Boost	Virtualization Tech	Execute Disable Bit	Enhanced Intel SpeedStep™ Technology	Intel 64 Tech (EM64T)	Trusted Execution Tech	Available date
Intel Celeron Processor E1200	1.60GHz	512KB	800MHz	Dual	No	No	Yes	Yes	Yes	No	Jan 2008
Intel Celeron Processor E1400	2.00GHz	512KB	800MHz	Dual	No	No	Yes	Yes	Yes	No	Apr 2008
Intel Celeron Processor E1500	2.20GHz	512KB	800MHz	Dual	No	No	Yes	Yes	Yes	No	Dec 2008
<hr/>											
Processor generation	Conroe										
Marketing name	Intel Celeron Processor										
Core	Dual-core										
Branding	Value or essential desktop processor										
<hr/>											
Micro-architecture	Intel Core Micro-architecture										
Intel Wide Dynamic Execution	Each core can complete up to four full instructions simultaneously using 14-stage pipeline;										
Intel Smart Memory Access	Hides memory latency										
Intel Advanced Digital Media Boost	Accelerates execution of Streaming SIMD Extension (SSE2/3) instructions used in multimedia applications										
Power mgmt technology	Enhanced Intel SpeedStep™ technology (EIST)										
Hyper-Threading	No										
Execute Disable (XD) Bit	Protects memory data areas from malicious software execution										
Intel 64 Technology ¹ (EM64T)	Intel 64 Technology (an extension to the IA-32 instruction set which adds 64 bit extensions to the x86 architecture)										
Intel Virtualization Technology	No										
Intel Trusted Execution Technology	No										
<hr/>											
L1 cache	64KB per core split between data cache (32KB) and instruction cache (32KB)										
L1 data cache	2x32KB data cache / integrated										
L1 instruction cache	2x32KB instruction cache / integrated										
<hr/>											
L2 cache - size	512KB / full speed / shared between both cores (Intel Advanced Smart Cache)										
L2 cache - data path	256-bit data path (32 bytes) / 64 byte cache line size / 8-way set associative / integrated / unified (on die)										
<hr/>											
System bus	800MHz (transfers data 4 times per clock) / address bus transfers at 2 times per clock										
Memory addressability	64GB memory addressability (but limited by chipset) / 36-bit addressing										
System bus - width	64-bit data path										
<hr/>											
Execution units	2 integer units, 1 floating point units, 1 load unit, 1 store unit										
Math coprocessor	Pipelined floating point unit										
Compatibility	Compatible with IA-32 software										
<hr/>											
Process technology	65nm or 0.065u										
Thermal Design Power	65 watts										
Package and connector	775-land Flip-Chip Land Grid Array (FC-LGA6) package requires LGA775 socket (socket also called Socket T)										
Chipset support	Intel G31 Express Chipset families; other compatible chipsets										

All trademarks are the property of their respective owners
© Lenovo

(DCEL) Compiled by Roger Dodson, Lenovo. January 2009

[Desktop] Intel Pentium Processor

Intel® Pentium® Processor	Clock Perf Mode	Shared L2 cache	System bus MHz	Hyper-Threading Core Technology	Total threads (logical)	Virtualization Tech	Execute Disable Bit	Enhanced Intel SpeedStep™ Technology	Intel 64 Tech (EM64T)	Trusted Execution Tech	Available date	
Intel Pentium Processor E2140	1.60GHz	1MB	800MHz	Dual	No	2	No	Yes	Yes	Yes	No	Jun 2007
Intel Pentium Processor E2160	1.80GHz	1MB	800MHz	Dual	No	2	No	Yes	Yes	Yes	No	Jun 2007
Intel Pentium Processor E2180	2.00GHz	1MB	800MHz	Dual	No	2	No	Yes	Yes	Yes	No	Aug 2007
Intel Pentium Processor E2200	2.20GHz	1MB	800MHz	Dual	No	2	No	Yes	Yes	Yes	No	Dec 2007
Intel Pentium Processor E2220	2.40GHz	1MB	800MHz	Dual	No	2	No	Yes	Yes	Yes	No	Mar 2008
Intel Pentium Processor E5200	2.50GHz	2MB	800MHz	Dual	No	2	No	Yes	Yes	Yes	No	Aug 2008
Intel Pentium Processor E5300	2.60GHz	2MB	800MHz	Dual	No	2	No	Yes	Yes	Yes	No	Dec 2008
Processor generation	<i>E2xxx: Conroe; E5xxx: Wolfdale</i>											
Marketing name	Intel Pentium Processor											
Core	Dual-core											
Branding	Value or essential desktop processor											
Micro-architecture	Intel Core Micro-architecture											
Intel Wide Dynamic Execution	Each core can complete up to four full instructions simultaneously using 14-stage pipeline;											
Intel Smart Memory Access	Hides memory latency											
Intel Advanced Digital Media Boost	Accelerates execution of Streaming SIMD Extension (SSE2/3) instructions used in multimedia applications											
Power mgmt technology	Enhanced Intel SpeedStep™ technology											
Thermal management	Digital thermal sensor											
Hyper-Threading	No											
Total threads	Two threads (two cores with no Hyper-Threading support provide two logical processors)											
Execute Disable (XD) Bit	Protects memory data areas from malicious software execution											
Intel 64 Technology ¹ (EM64T)	Intel 64 Technology (an extension to the IA-32 instruction set which adds 64 bit extensions to the x86 architecture)											
Intel Virtualization Technology	No											
Intel Trusted Execution Technology	No											
L1 cache	64KB per core split between data cache (32KB) and instruction cache (32KB)											
L1 data cache	2x32KB data cache / integrated											
L1 instruction cache	2x32KB instruction cache / integrated											
L2 cache - size	1MB or 2MB / full speed / shared between both cores (Intel Advanced Smart Cache)											
L2 cache - data path	256-bit data path (32 bytes) / 64 byte cache line size / 8-way set associative / integrated / unified (on die)											
L3 cache	None											
System bus	800MHz (transfers data 4 times per clock) / address bus transfers at 2 times per clock											
Memory addressability	64GB memory addressability (but limited by chipset) / 36-bit addressing											
System bus - width	64-bit data path											
Execution units	2 integer units, 1 floating point units, 1 load unit, 1 store unit											
Math coprocessor	Pipelined floating point unit											
Compatibility	Compatible with IA-32 software											
Process technology	<i>E2xxx: 65nm; E5xxx: 45nm</i>											
Thermal Design Power	65 watts											
Package and connector	775-land Flip-Chip Land Grid Array (FC-LGA6) package requires LGA775 socket (socket also called Socket T)											
Chipset support	Intel G31 Express Chipset; Intel 4 Series Express Chipset family; other compatible chipsets											

All trademarks are the property of their respective owners
 © Lenovo

(E2) Compiled by Roger Dodson, Lenovo. January 2009

[Desktop] Intel Core 2 Duo Processor

<i>Intel® Core™ 2 Duo processor for desktop systems</i>	Clock Perf Mode	Shared L2 cache	System bus MHz	Hyper-Threading Core Technology	Virtualization Tech	Execute Disable Bit	Enhanced Intel SpeedStep™ Technology	Intel 64 Tech (EM64T)	Trusted Execution Tech	Available date	
Intel Core 2 Duo processor E4300	1.80GHz	2MB	800MHz	Dual	No	No	Yes	Yes	No	Jan 2007	
Intel Core 2 Duo processor E4400	2.00GHz	2MB	800MHz	Dual	No	No	Yes	Yes	No	Apr 2007	
Intel Core 2 Duo processor E4500	2.20GHz	2MB	800MHz	Dual	No	No	Yes	Yes	No	July 2007	
Intel Core 2 Duo processor E4600	2.40GHz	2MB	800MHz	Dual	No	No	Yes	Yes	No	Oct 2007	
Intel Core 2 Duo processor E4700	2.60GHz	2MB	800MHz	Dual	No	No	Yes	Yes	No	Mar 2008	
Intel Core 2 Duo processor E6300	1.86GHz	2MB	1066MHz	Dual	No	Yes	Yes	Yes	No	July 2006	
Intel Core 2 Duo processor E6320	1.86GHz	4MB	1066MHz	Dual	No	Yes	Yes	Yes	No	Apr 2007	
Intel Core 2 Duo processor E6400	2.13GHz	2MB	1066MHz	Dual	No	Yes	Yes	Yes	No	July 2006	
Intel Core 2 Duo processor E6420	2.13GHz	4MB	1066MHz	Dual	No	Yes	Yes	Yes	No	Apr 2007	
Intel Core 2 Duo processor E6540	2.33GHz	4MB	1333MHz	Dual	No	Yes	Yes	Yes	No	July 2007	
Intel Core 2 Duo processor E6550	2.33GHz	4MB	1333MHz	Dual	No	Yes	Yes	Yes	Yes	July 2007	
Intel Core 2 Duo processor E6600	2.40GHz	4MB	1066MHz	Dual	No	Yes	Yes	Yes	No	July 2006	
Intel Core 2 Duo processor E6700	2.66GHz	4MB	1066MHz	Dual	No	Yes	Yes	Yes	No	July 2006	
Intel Core 2 Duo processor E6750	2.66GHz	4MB	1333MHz	Dual	No	Yes	Yes	Yes	Yes	July 2007	
Intel Core 2 Duo processor E6850	3.00GHz	4MB	1333MHz	Dual	No	Yes	Yes	Yes	Yes	July 2007	
Processor generation	Conroe										
Marketing name	Intel Core 2 Duo desktop processor										
Core	Dual-core										
Branding	Part of the Intel Viiv™ technology for the home and Intel vPro™ technology for business										
Micro-architecture	Intel Core Micro-architecture										
Intel Wide Dynamic Execution	Each core can complete up to four full instructions simultaneously using 14-stage pipeline										
Intel Smart Memory Access	Hides memory latency										
Intel Advanced Digital Media Boost	Accelerates execution of Streaming SIMD Extension (SSE2/3) instructions used in multimedia applications										
Power mgmt technology	Enhanced Intel SpeedStep™ technology										
Thermal management	Digital thermal sensor										
Hyper-Threading	No										
Total threads	Two threads (two cores with no Hyper-Threading support provide two logical processors)										
Execute Disable (XD) Bit	Protects memory data areas from malicious software execution										
Intel 64 Technology ¹ (EM64T)	Intel 64 Technology (an extension to the IA-32 instruction set which adds 64 bit extensions to the x86 architecture)										
Virtualization Technology	<i>Some:</i> Intel Virtualization Technology										
Intel Trusted Execution Technology	<i>Some:</i> enables more secure platforms from software-based attacks with appropriate software										
Intel Dynamic Acceleration	No										
L1 cache	64KB per core split between data cache (32KB) and instruction cache (32KB)										
L1 data cache	2x32KB data cache, integrated										
L1 instruction cache	2x32KB instruction cache, integrated										
L2 cache - size	2MB or 4MB , full speed, shared between both cores (Intel Advanced Smart Cache)										
L2 cache - data path	256-bit data path (32 bytes), 64 byte cache line size, 8-way set associative, integrated, unified (on die)										
L3 cache	None										
System bus	800MHz, 1066MHz, or 1333MHz (transfers data 4 times per clock) / address bus transfers at 2 times per clock										
Memory addressability	64GB memory addressability (but limited by chipset), 36-bit addressing										
System bus - width	64-bit data path										
Execution units	2 integer units, 1 floating point units, 1 load unit, 1 store unit										
Math coprocessor	Pipelined floating point unit										
Compatibility	Compatible with IA-32 software										
Process technology	65nm										
Thermal Design Power	65 watts										
Package and connector	775-land Flip-Chip Land Grid Array (FC-LGA6) package requires LGA775 socket (socket also called Socket T)										
Chipset support	Intel Q963, Q965, G965, P965, 946, 975X Express Chipset families ; other compatible chipsets										

[Desktop] Intel Core 2 Duo Processor (Wolfdale)

Personal Systems Reference (PSREF)

<i>Intel® Core™ 2 Duo processor for desktop systems</i>	Clock Perf Mode	Shared L2 cache	System bus MHz	Core	Virtualization Tech	Execute Disable Bit	Enhanced Intel SpeedStep™ Technology	Intel 64 Tech	Trusted Execution Tech	Intel Dynamic Acceleration	Available date
Intel Core 2 Duo processor E7200	2.53GHz	3MB	1066MHz	Dual	No	Yes	Yes	Yes	No	No	Apr 2008
Intel Core 2 Duo processor E7300	2.66GHz	3MB	1066MHz	Dual	No	Yes	Yes	Yes	No	No	Aug 2008
Intel Core 2 Duo processor E7400	2.80GHz	3MB	1066MHz	Dual	No	Yes	Yes	Yes	No	No	Oct 2008
Intel Core 2 Duo processor E8190	2.66GHz	6MB	1333MHz	Dual	No	Yes	Yes	Yes	No	No	Jan 2008
Intel Core 2 Duo processor E8200	2.66GHz	6MB	1333MHz	Dual	Yes	Yes	Yes	Yes	Yes	No	Jan 2008
Intel Core 2 Duo processor E8300	2.83GHz	6MB	1333MHz	Dual	Yes	Yes	Yes	Yes	Yes	No	Apr 2008
Intel Core 2 Duo processor E8400	3.00GHz	6MB	1333MHz	Dual	Yes	Yes	Yes	Yes	Yes	No	Jan 2008
Intel Core 2 Duo processor E8500	3.16GHz	6MB	1333MHz	Dual	Yes	Yes	Yes	Yes	Yes	No	Jan 2008
Intel Core 2 Duo processor E8600	3.33GHz	6MB	1333MHz	Dual	Yes	Yes	Yes	Yes	Yes	No	May 2008
Processor generation	Wolfdale										
Marketing name	Intel Core 2 Duo desktop processor										
Core	Dual-core										
Branding	Supports Intel Core 2 Processor with Viiv™ technology and Intel Core 2 Processor with vPro™ technology when hardware and software requirements met										
Micro-architecture	Intel Core Micro-architecture										
Intel Wide Dynamic Execution	Each core can complete up to four full instructions simultaneously using 14-stage pipeline										
Intel Smart Memory Access	Hides memory latency										
Intel Advanced Digital Media Boost	Accelerates execution of Streaming SIMD Extension (SSE2/3) instructions used in multimedia applications										
Intel HD Boost	Streaming SIMD Extensions 4 (SSE4) and faster Super Shuffle Engine										
Power mgmt technology	Enhanced Intel SpeedStep™ technology										
Hyper-Threading	No										
Total threads	Two threads (two cores with no Hyper-Threading support provide two logical processors)										
Execute Disable (XD) Bit	Protects memory data areas from malicious software execution										
Intel 64 Technology ¹	Intel 64 Technology (an extension to the IA-32 instruction set which adds 64 bit extensions to the x86 architecture)										
Virtualization Technology	<i>Some:</i> Intel Virtualization Technology										
Intel Trusted Execution Technology	<i>Some:</i> Enables more secure platforms from software-based attacks with appropriate software										
Intel Dynamic Acceleration	None										
L1 cache	64KB per core split between data cache (32KB) and instruction cache (32KB)										
L1 data cache	2x32KB data cache, integrated										
L1 instruction cache	2x32KB instruction cache, integrated										
L2 cache - size	3MB or 6MB , full speed, shared between both cores (Intel Advanced Smart Cache)										
L2 cache - data path	256-bit data path (32 bytes), 64 byte cache line size, 8-way set associative, integrated, unified (on die)										
L3 cache	None										
System bus (front side bus)	1066MHz or 1333MHz (transfers data 4 times per clock), address bus transfers at 2 times per clock										
Memory addressability	64GB memory addressability (but limited by chipset), 36-bit addressing										
System bus - width	64-bit data path										
Execution units	2 integer units, 1 floating point units, 1 load unit, 1 store unit										
Math coprocessor	Pipelined floating point unit										
Compatibility	Compatible with IA-32 software										
Process technology	45nm										
Thermal Design Power	65 watts										
Package and connector	775-land Flip-Chip Land Grid Array (FC-LGA8) package requires LGA775 socket (socket also called Socket T)										
Chipset support	Intel 3 Series and Intel 4 Series Express Chipset families; other compatible chipsets										

All trademarks are the property of their respective owners
© Lenovo

(WOLF) Compiled by Roger Dodson, Lenovo. October 2008

[Desktop] Intel Core 2 Extreme Processor

Personal Systems Reference (PSREF)

Intel® Core™ 2 Extreme processor for desktop systems	Clock Perf Mode	L2 cache	System bus MHz	Core	Thermal Design Power	Socket	Virtualization Tech	Execute Disable Bit	Enhanced Intel SpeedStep™ Technology	Intel 64 Tech (EM64T)	Available date
Intel Core 2 Extreme processor X6800	2.93GHz	4MB	1066MHz	Dual	75W	LGA775	Yes	Yes	Yes	Yes	July 2006
Intel Core 2 Extreme processor QX6700	2.66GHz	8MB	1066MHz	Quad	75W	LGA775	Yes	Yes	Yes	Yes	Apr 2007
Intel Core 2 Extreme processor QX6800	2.93GHz	8MB	1066MHz	Quad	75W	LGA775	Yes	Yes	Yes	Yes	Apr 2007
Intel Core 2 Extreme processor QX6850	3.00GHz	8MB	1333MHz	Quad	75W	LGA775	Yes	Yes	Yes	Yes	July 2007
Intel Core 2 Extreme processor QX9650	3.00GHz	12MB	1333MHz	Quad	130W	LGA775	Yes	Yes	Yes	Yes	Nov 2007
Intel Core 2 Extreme processor QX9770	3.20GHz	12MB	1600MHz	Quad	136W	LGA775	Yes	Yes	Yes	Yes	Nov 2007
Intel Core 2 Extreme processor QX9775	3.20GHz	12MB	1600MHz	Quad	150W	LGA771	Yes	Yes	Yes	Yes	Feb 2008

Processor generation **Conroe (X6800) or Kentsfield (QX6xxx) or Yorkfield-XE (QX9xxx)**
 Marketing name **Intel Core 2 Extreme processor**
 Core **Dual-core or quad-core**
 Branding Part of the **Intel Viiv™ technology** for the home and **Intel vPro™ processor technology** for business

Micro-architecture Intel Core micro-architecture
 Intel Wide Dynamic Execution Each core can complete up to four full instructions simultaneously using 14-stage pipeline;
 Intel Smart Memory Access Hides memory latency
 Intel Advanced Digital Media Boost Accelerates execution of Streaming SIMD Extension (SSE2/3) instructions used in multimedia applications
 Intel HD Boost QX9xxx: Streaming SIMD Extensions 4 (SSE4) and faster Super Shuffle Engine
 Power mgmt technology Enhanced Intel SpeedStep™ technology
 Thermal management Digital thermal sensor
 Hyper-Threading No
 Total threads Two or four threads (two or four cores with no Hyper-Threading)
 Execute Disable (XD) Bit Protects memory data areas from malicious software execution
 Intel 64 Technology¹ (EM64T) Intel 64 Technology (an extension to the IA-32 instruction set which adds 64 bit extensions to the x86 architecture)
 Virtualization Technology Intel Virtualization Technology

L1 cache 64KB per core split between data cache (32KB) and instruction cache (32KB)
 L1 data cache 2x32KB data cache / integrated
 L1 instruction cache 2x32KB instruction cache / integrated

L2 cache - size X6800: **4MB** / full speed / shared between both cores (Intel Advanced Smart Cache)
 QX6xxx: **8MB** / full speed / 2 x 4MB shared cache on each die [dual-die] (Intel Advanced Smart Cache)
 QX9xxx: **12MB** / full speed / 2 x 6MB shared cache on each die [dual-die] (Intel Advanced Smart Cache)
 L2 cache - data path 256-bit data path (32 bytes) / 64 byte cache line size / 8-way set associative / integrated / unified (on die)
 L3 cache None

System bus **1066MHz or 1333MHz** (transfers data 4 times per clock) / address bus transfers at 2 times per clock
 Memory addressability 64GB memory addressability (but limited by chipset) / 36-bit addressing
 System bus - width 64-bit data path

Execution units per core 2 integer units, 1 floating point units, 1 load unit, 1 store unit
 Math coprocessor Pipelined floating point unit
 Compatibility Compatible with IA-32 software

Process technology *Others:* 65nm or 0.065u
 QX9xxx: 45nm or 0.045u

Package and connector **775-land Flip-Chip Land Grid Array (FC-LGA6) package** requires **LGA771** or **LGA775 socket** (also called Socket T)

Chipset support Intel Q963, Q965, G965, P965, 975X Express Chipset families; Intel 3 Series; other compatible chipsets

[Desktop] Intel Core 2 Quad Processor

Intel® Core™ 2 Quad processor for desktop systems	Clock Perf Mode	L2 cache	System bus MHz	Cores	Hyper-Threading Technology	Total threads (logical)	Virtualization Tech	Enhanced Intel SpeedStep™ Technology	Intel 64 Tech	Trusted Execution Tech	Available date
Intel Core 2 Quad processor Q6600	2.40GHz	8MB	1066MHz	Quad	No	4	Yes	Yes	Yes	No	Jan 2007
Intel Core 2 Quad processor Q6700	2.66GHz	8MB	1066MHz	Quad	No	4	Yes	Yes	Yes	No	July 2007
Intel Core 2 Quad processor Q8200	2.33GHz	4MB	1333MHz	Quad	No	4	No	Yes	Yes	No	Aug 2008
Intel Core 2 Quad processor Q8300	2.50GHz	4MB	1333MHz	Quad	No	4	No	Yes	Yes	No	Dec 2008
Intel Core 2 Quad processor Q9300	2.50GHz	6MB	1333MHz	Quad	No	4	Yes	Yes	Yes	Yes	Mar 2008
Intel Core 2 Quad processor Q9400	2.66GHz	6MB	1333MHz	Quad	No	4	Yes	Yes	Yes	Yes	Aug 2008
Intel Core 2 Quad processor Q9450	2.66GHz	12MB	1333MHz	Quad	No	4	Yes	Yes	Yes	Yes	Mar 2008
Intel Core 2 Quad processor Q9550	2.83GHz	12MB	1333MHz	Quad	No	4	Yes	Yes	Yes	Yes	Mar 2008
Intel Core 2 Quad processor Q9650	3.00GHz	12MB	1333MHz	Quad	No	4	Yes	Yes	Yes	Yes	Aug 2008

Processor generation	Kentsfield (Q6xxx) or Yorkfield (Q8xxx, Q9xxx)
Marketing name	Intel Core 2 Quad desktop processor
Core	Quad-core (dual-core on dual-die so essentially two Core 2 Duo processors joined together)
Branding	Supports Intel Core 2 Processor with Viiv™ technology and Intel Core 2 Processor with vPro™ technology when hardware and software requirements met
Micro-architecture	Intel Core Micro-architecture
Intel Wide Dynamic Execution	Each core can complete up to four full instructions simultaneously using 14-stage pipeline;
Intel Smart Memory Access	Hides memory latency
Intel Advanced Digital Media Boost	Accelerates execution of Streaming SIMD Extension (SSE2/3) instructions used in multimedia applications
Intel HD Boost	Q8xxx/Q9xxx: Streaming SIMD Extensions 4 (SSE4) and faster Super Shuffle Engine
Power mgmt technology	Enhanced Intel SpeedStep™ technology
Thermal management	Digital thermal sensor
Hyper-Threading	No
Total threads	Two threads (two cores with no Hyper-Threading support provide two logical processors)
Execute Disable (XD) Bit	Protects memory data areas from malicious software execution
Intel 64 Technology ¹ (EM64T)	Intel 64 Technology (an extension to the IA-32 instruction set which adds 64 bit extensions to the x86 architecture)
Virtualization Technology	<i>Some:</i> Intel Virtualization Technology
Intel Trusted Execution Technology	<i>Some:</i> Enables more secure platforms from software-based attacks with appropriate software
Intel Dynamic Acceleration	No
L1 cache	Four 32KB per core, integrated
L2 cache - size	4MB, 6MB, 8MB, or 12MB / full speed, 2 x 3MB/4MB/6MB shared cache on each die [dual-die] (Intel Advanced Smart Cache)
L2 cache - data path	256-bit data path (32 bytes), 64 byte cache line size, 8-way set associative, integrated
L3 cache	None
System bus	1066MHz or 1333MHz (transfers data 4 times per clock), address bus transfers at 2 times per clock
Memory addressability	64GB memory addressability (but limited by chipset), 36-bit addressing
System bus - width	64-bit data path
Execution units per core	2 integer units, 1 floating point units, 1 load unit, 1 store unit
Math coprocessor	Pipelined floating point unit
Compatibility	Compatible with IA-32 software
Process technology	Q6xxx: 65nm; Q8xxx/9xxx: 45nm
Thermal Design Power	Q6xxx: 65 watts; Q8xxx/9xxx: 95 watts
Package and connector	Q6xxx: 775-land Flip-Chip Land Grid Array (FC-LGA6) package requires LGA775 socket (socket also called Socket T) Q8xxx/9xxx: 775-land Flip-Chip Land Grid Array (FC-LGA8) package requires LGA775 socket (socket also called Socket T)
Chipset support	Intel 3 Series and Intel 4 Series desktop chipset; other compatible chipsets

[Desktop] Intel Core i7 Processor

<i>Intel® Core™ i7 processor for desktops</i>	Clock speed	Shared L3 cache	Quick Path Interconnect	Core	Virtualization Tech	Hyper-Threading Tech	Intel 64 Tech	Intel Turbo Boost	Available date
Intel Core i7-920 Processor	2.66GHz	8MB	4.8GT/s	Quad	Yes	Yes	Yes	Yes	Jan 2009
Intel Core i7-940 Processor	2.93GHz	8MB	4.8GT/s	Quad	Yes	Yes	Yes	Yes	Jan 2009

Processor generation	Bloomfield (Nehalem)
Marketing name	Intel Core i7 processor
Core	Quad-core
Micro-architecture	Intel Core Micro-architecture
Intel Wide Dynamic Execution	Each core can complete up to four full instructions simultaneously using 14-stage pipeline
Intel Smart Memory Access	Hides memory latency
Intel Advanced Digital Media Boost	Streaming SIMD Extensions (SSE2, SSE3)
Intel HD Boost	Streaming SIMD Extensions 4 (SSE4), Super Shuffle Engine, SSE4.2
Power mgmt technology	Enhanced Intel SpeedStep™ technology, power management capabilities, multiple low-power states
Hyper-Threading	Intel Hyper-Threading Technology ²
Total threads	Eight threads (four cores with Hyper-Threading support provide eight threads)
Execute Disable Bit	Protects memory data areas from malicious software execution
Intel 64 Technology ¹	Intel 64 Technology (extension to IA-32 instruction set adding 64-bit extensions)
Virtualization Technology	Intel Virtualization Technology
Intel Trusted Execution Technology	None
Intel Dynamic Acceleration	None
Turbo Boost	Intel Turbo Boost Technology ³ (scales processor frequency higher)
L1 cache	64KB per core, split between data cache (32KB) and instruction cache (32KB), 8-way set associative
L2 cache	256KB per core, unified, 8-way set associative
L3 cache	8MB shared among all cores (Intel Smart Cache), 16-way set associative
Memory controller	Integrated memory controller
Memory support	DDR3, three channels max, two DIMMs per channel max, 24GB max, 800/1066MHz
System bus (front side bus)	None
QuickPath Interconnect	Intel QuickPath Interconnect, point-to-point link between processor and chipset, 4.8GT/sec max
Compatibility	Compatible with IA-32 software
Process technology	45nm
Thermal Design Power	130 watts
Package and connector	1366-land Flip-Chip Land Grid Array (FC-LGA8) package requires LGA1366 socket
Chipset support	Intel X58 Express Chipset families; other compatible chipsets

All trademarks are the property of their respective owners
 © Lenovo

(17) Compiled by Roger Dodson, Lenovo. December 2008

[Desktop] Intel Core i7 Processor Extreme Edition

Personal Systems Reference (PSREF)

Intel® Core™ i7 processor Extreme Edition for desktops and workstations	Clock speed	Shared L3 cache	Quick Path Interconnect	Core	Virtualization Tech	Hyper-Threading Tech	Intel 64 Tech	Intel Turbo Boost	Available date
Intel Core i7-965 Processor Extreme Edition	3.2GHz	8MB	6.4GT/s	Quad	Yes	Yes	Yes	Yes	Jan 2009

Processor generation	Bloomfield (Nehalem)
Marketing name	Intel Core i7 processor Extreme Edition
Core	Quad-core
Micro-architecture	Intel Core Micro-architecture
Intel Wide Dynamic Execution	Each core can complete up to four full instructions simultaneously using 14-stage pipeline
Intel Smart Memory Access	Hides memory latency
Intel Advanced Digital Media Boost	Streaming SIMD Extensions (SSE2, SSE3)
Intel HD Boost	Streaming SIMD Extensions 4 (SSE4), Super Shuffle Engine, SSE4.2
Power mgmt technology	Enhanced Intel SpeedStep™ technology, power management capabilities, multiple low-power states
Hyper-Threading	Intel Hyper-Threading Technology ²
Total threads	Eight threads (four cores with Hyper-Threading support provide eight threads)
Execute Disable Bit	Protects memory data areas from malicious software execution
Intel 64 Technology ¹	Intel 64 Technology (extension to IA-32 instruction set adding 64-bit extensions)
Virtualization Technology	Intel Virtualization Technology
Intel Trusted Execution Technology	None
Intel Dynamic Acceleration	None
Turbo Boost	Intel Turbo Boost Technology ³ (scales processor frequency higher)
L1 cache	64KB per core, split between data cache (32KB) and instruction cache (32KB), 8-way set associative
L2 cache	256KB per core, unified, 8-way set associative
L3 cache	8MB shared among all cores (Intel Smart Cache), 16-way set associative
Memory controller	Integrated memory controller
Memory support	DDR3, three channels max, two DIMMs per channel max, 24GB max, 800/1066MHz
System bus (front side bus)	None
QuickPath Interconnect	Intel QuickPath Interconnect, point-to-point link between processor and chipset, 6.4GT/sec max
Compatibility	Compatible with IA-32 software
Process technology	45nm
Thermal Design Power	130 watts
Package and connector	1366-land Flip-Chip Land Grid Array (FC-LGA8) package requires LGA1366 socket
Chipset support	Intel X58 Express Chipset families; other compatible chipsets

All trademarks are the property of their respective owners
 © Lenovo

(I7E) Compiled by Roger Dodson, Lenovo. December 2008

This publication could include technical inaccuracies or typographical errors. References herein to Lenovo products and services do not imply that Lenovo intends to make them available in other countries. LENOVO PROVIDES THIS PUBLICATION AS IS WITHOUT WARRANTY OF ANY KIND, EITHER EXPRESS OR IMPLIED, INCLUDING THE IMPLIED WARRANTIES OF MERCHANTABILITY OR FITNESS FOR A PARTICULAR PURPOSE. Some jurisdictions do not allow disclaimer of express or implied warranties; therefore this disclaimer may not apply to you.

¹ **Intel 64 Technology (formerly EM64T):**

Intel 64 Technology (formerly Intel EM64T) requires a computer system with a processor, chipset, BIOS, operating system, device drivers, and applications enabled for Intel 64 Technology. Processor will not operate (including 32-bit operation) without an Intel 64 Technology-enabled BIOS. Performance will vary depending on your hardware and software configurations.

² **Intel Hyper-Threading Technology (HT Technology):**

Intel Hyper-Threading Technology requires a computer system with a processor supporting HT Technology and an HT Technology-enabled chipset, BIOS, and operating system. Performance will vary depending on the specific hardware and software you use. For more information, including details on which processors support HT Technology, see www.intel.com/info/hyperthreading.

³ **Intel Turbo Boost Technology:** Intel Turbo Boost Technology requires a PC with a processor with Intel Turbo Boost Technology capability. Intel Turbo Boost Technology performance varies depending on hardware, software, and overall system configuration. Check with your PC manufacturer on whether your system delivers Intel Turbo Boost Technology. See www.intel.com/info/technology/turbo-boost for more information.

Trademarks: Lenovo, the Lenovo logo, New World. New Thinking., Access Connections, Rescue and Recovery, ThinkCentre, ThinkPad, ThinkStation, ThinkVantage, and ThinkVision are trademarks of Lenovo.

Intel logo, Intel Inside logo, Intel Core and Core Inside, Pentium, Celeron and Intel SpeedStep are trademarks or registered trademarks of Intel Corporation or its subsidiaries in the United States and other countries.

Other company, product and service names may be trademarks or service marks of others.

ThinkPad® | ThinkCentre®

Visit www.lenovo.com/safecomputing periodically for the latest information on safe and effective computing.

Visit www.lenovo.com/psref for the latest version of Personal Systems Reference.

© Lenovo, 2009.
All rights reserved.

Lenovo
1009 Think Place
Morrisville, NC 27560
U.S.A.

January 2009
tecbook.pdf